



US00D574883S

(12) **United States Design Patent**
Seino

(10) **Patent No.:** **US D574,883 S**

(45) **Date of Patent:** **** Aug. 12, 2008**

(54) **PRINTER**

(75) Inventor: **Takumi Seino**, Chiba (JP)

(73) Assignee: **Seiko Instrument Inc.**, Chiba-Shi (JP)

(**) Term: **14 Years**

(21) Appl. No.: **29/262,595**

(22) Filed: **Jul. 7, 2006**

(51) **LOC (8) Cl.** **18-02**

(52) **U.S. Cl.** **D18/50**

(58) **Field of Classification Search** D18/50,
D18/54, 54.1, 55; D14/420-425, 462-470;
400/613, 613.1-613.4, 691-694, 690.1-690.4
See application file for complete search history.

(56) **References Cited**

U.S. PATENT DOCUMENTS

3,263,557	A *	8/1966	Cunningham et al.	D18/36
4,754,293	A *	6/1988	Aizawa et al.	D18/36
D470,884	S *	2/2003	Gotham et al.	D18/55
2004/0175221	A1 *	9/2004	Sekino	400/613
2005/0286954	A1 *	12/2005	Suzuki et al.	400/613

2006/0171754 A1* 8/2006 Takami et al. 400/76

* cited by examiner

Primary Examiner—Cathy Anne MacCormac

(74) *Attorney, Agent, or Firm*—Finnegan, Henderson, Farabow, Garrett & Dunner, L.L.P.

(57) **CLAIM**

The ornamental design for a printer, as shown and described.

DESCRIPTION

FIG. 1 is a perspective view of top, rear and right side of a printer showing my new design;

FIG. 2 is a front view thereof;

FIG. 3 is a rear view thereof;

FIG. 4 is a left side view thereof;

FIG. 5 is a right side view thereof;

FIG. 6 is a top plan view thereof;

FIG. 7 is a bottom view thereof; and,

FIG. 8 is another perspective view thereof in an alternate position.

1 Claim, 8 Drawing Sheets

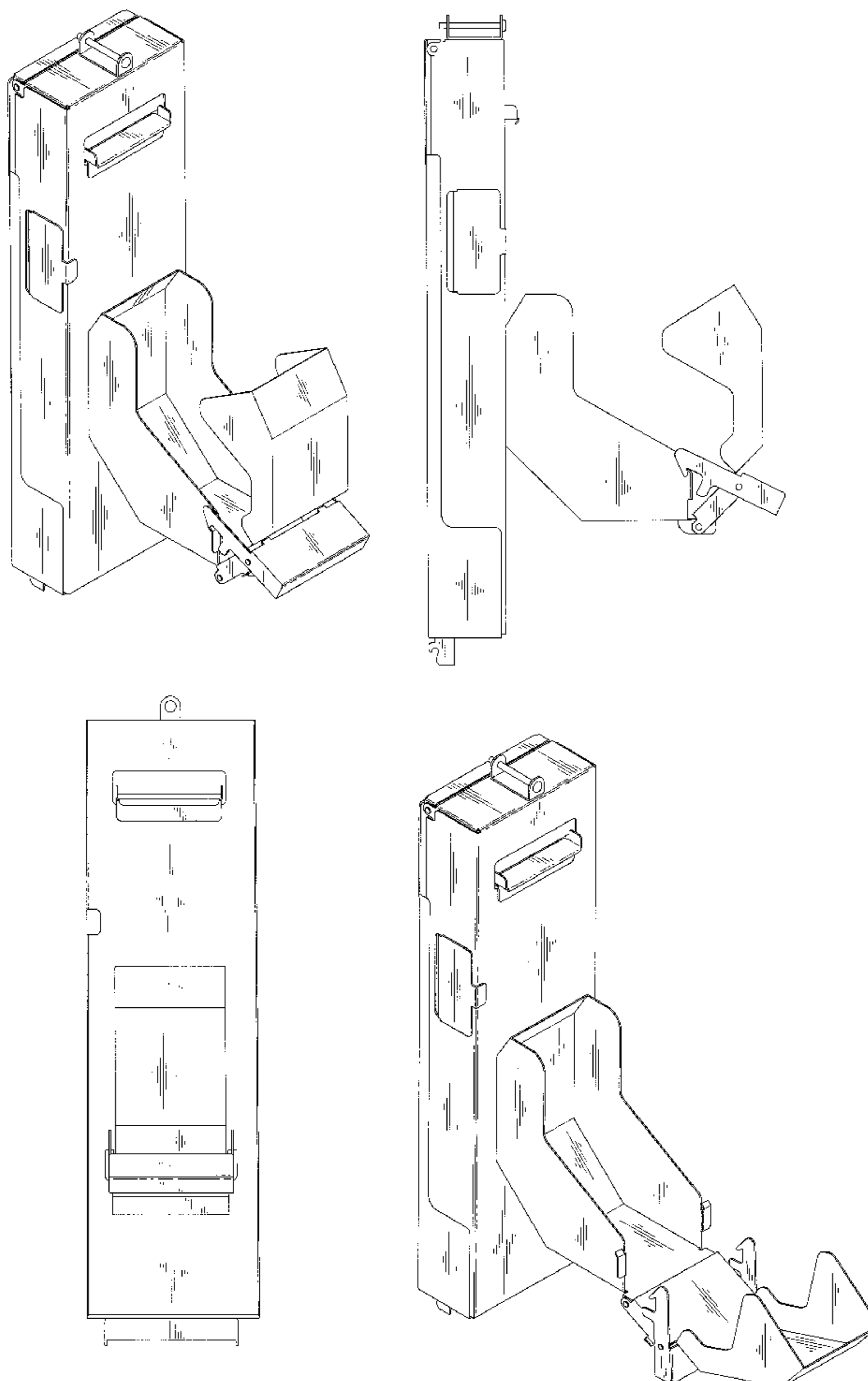

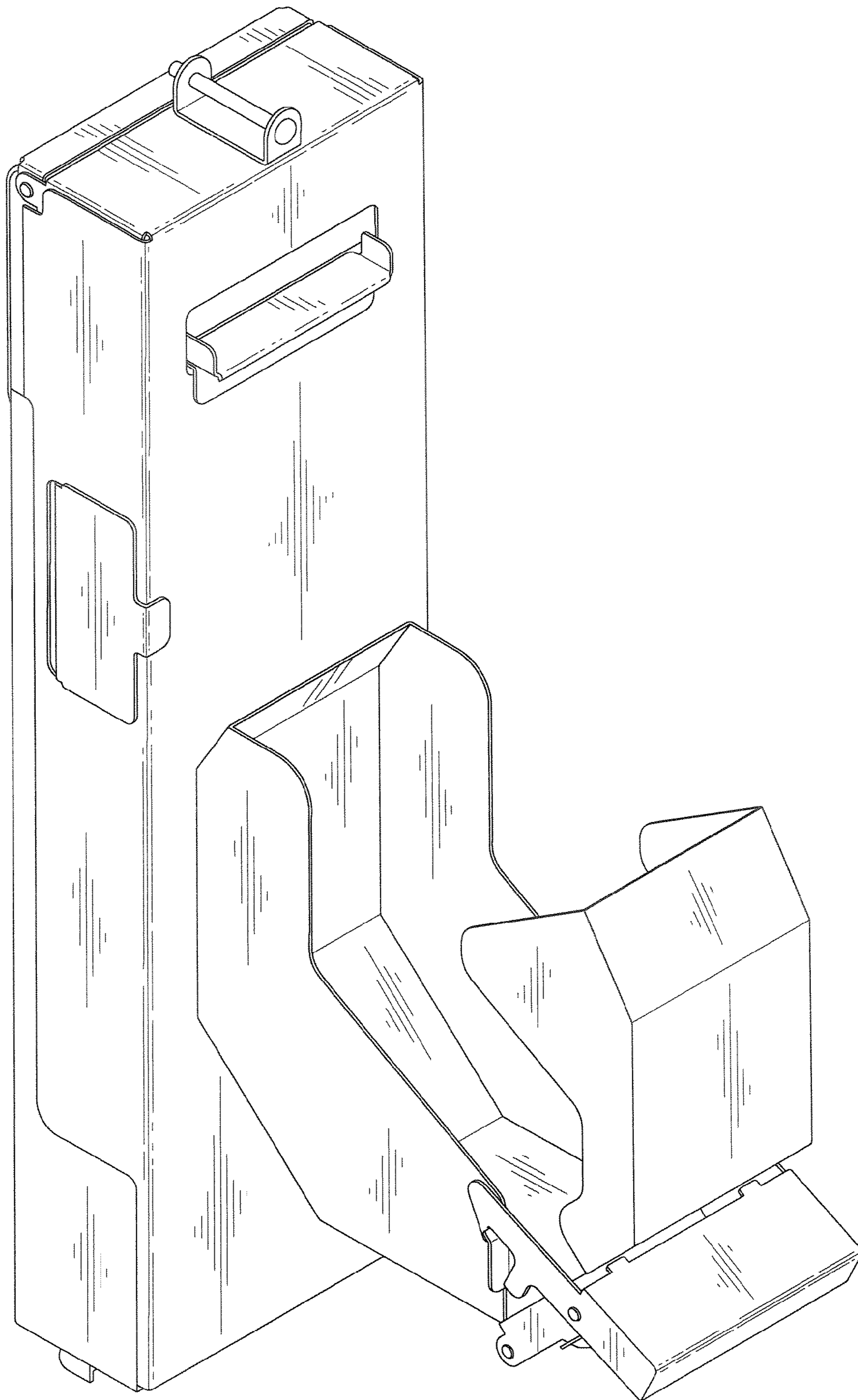

FIG. 1

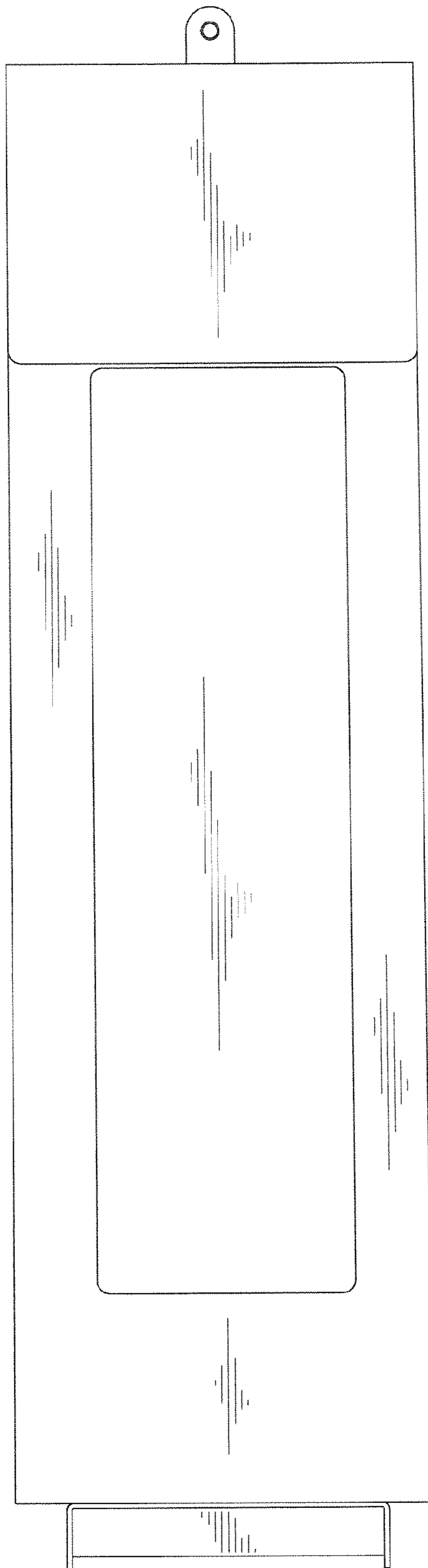

FIG. 2

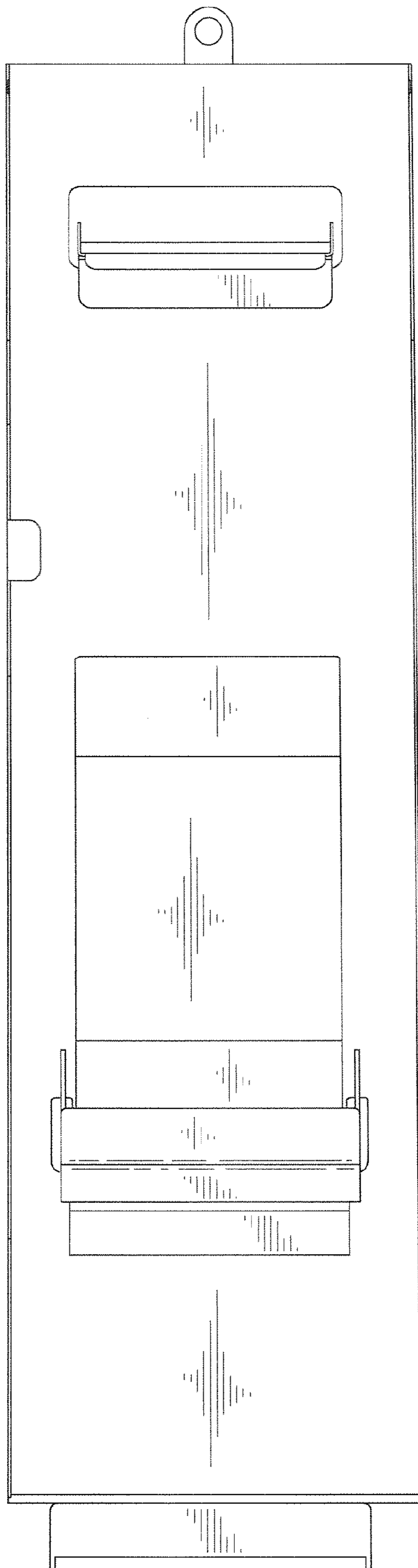

FIG. 3

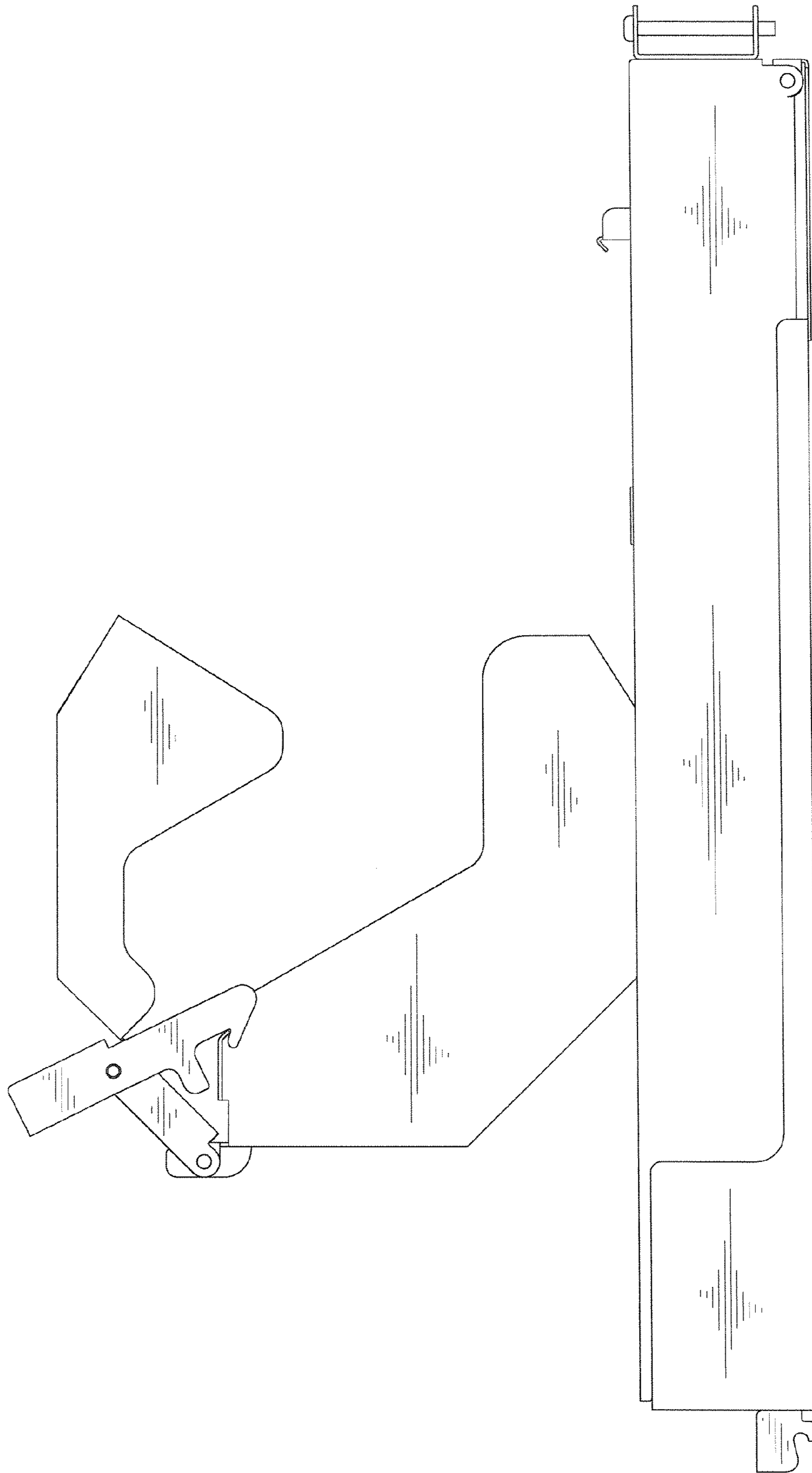

FIG. 4

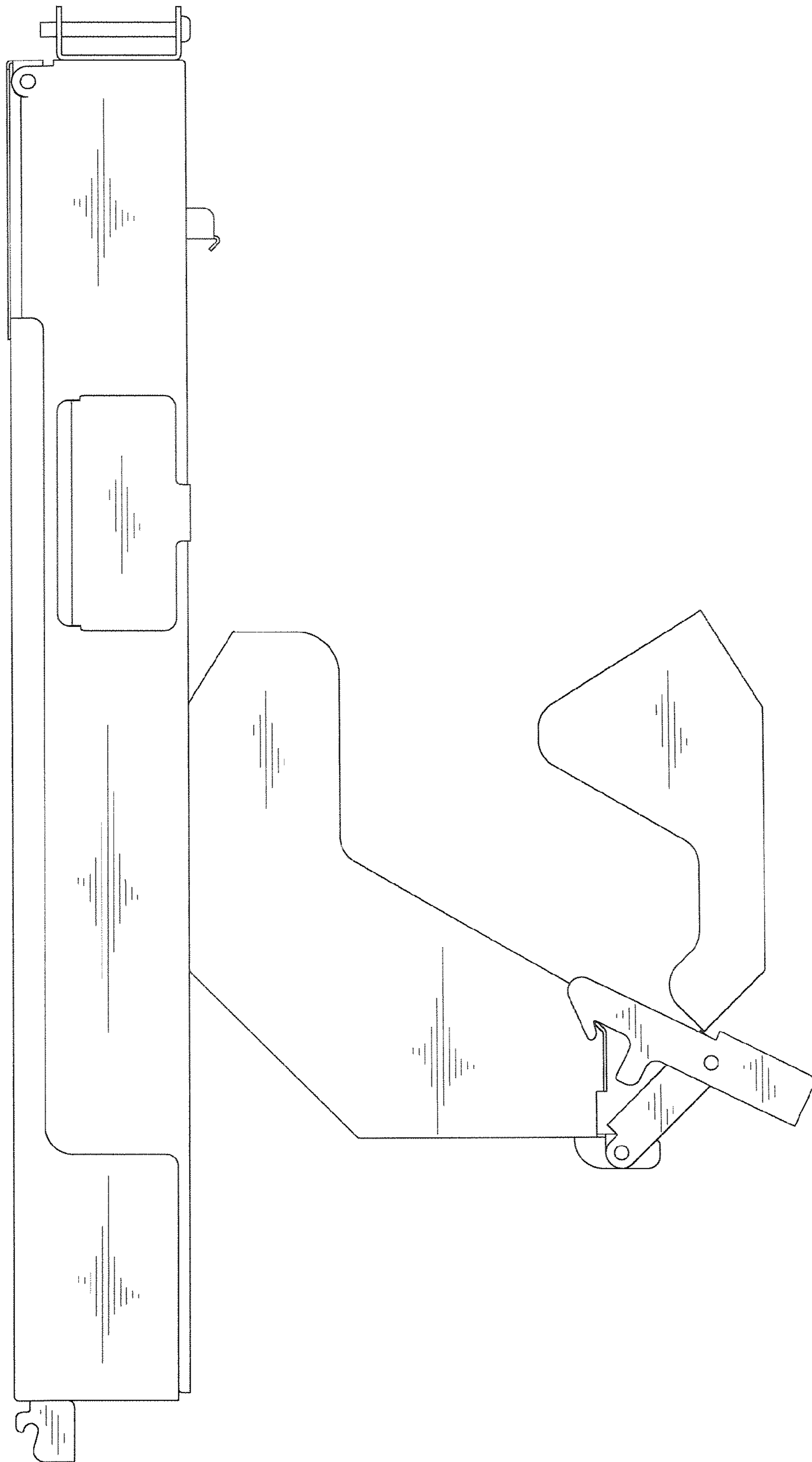

FIG. 5

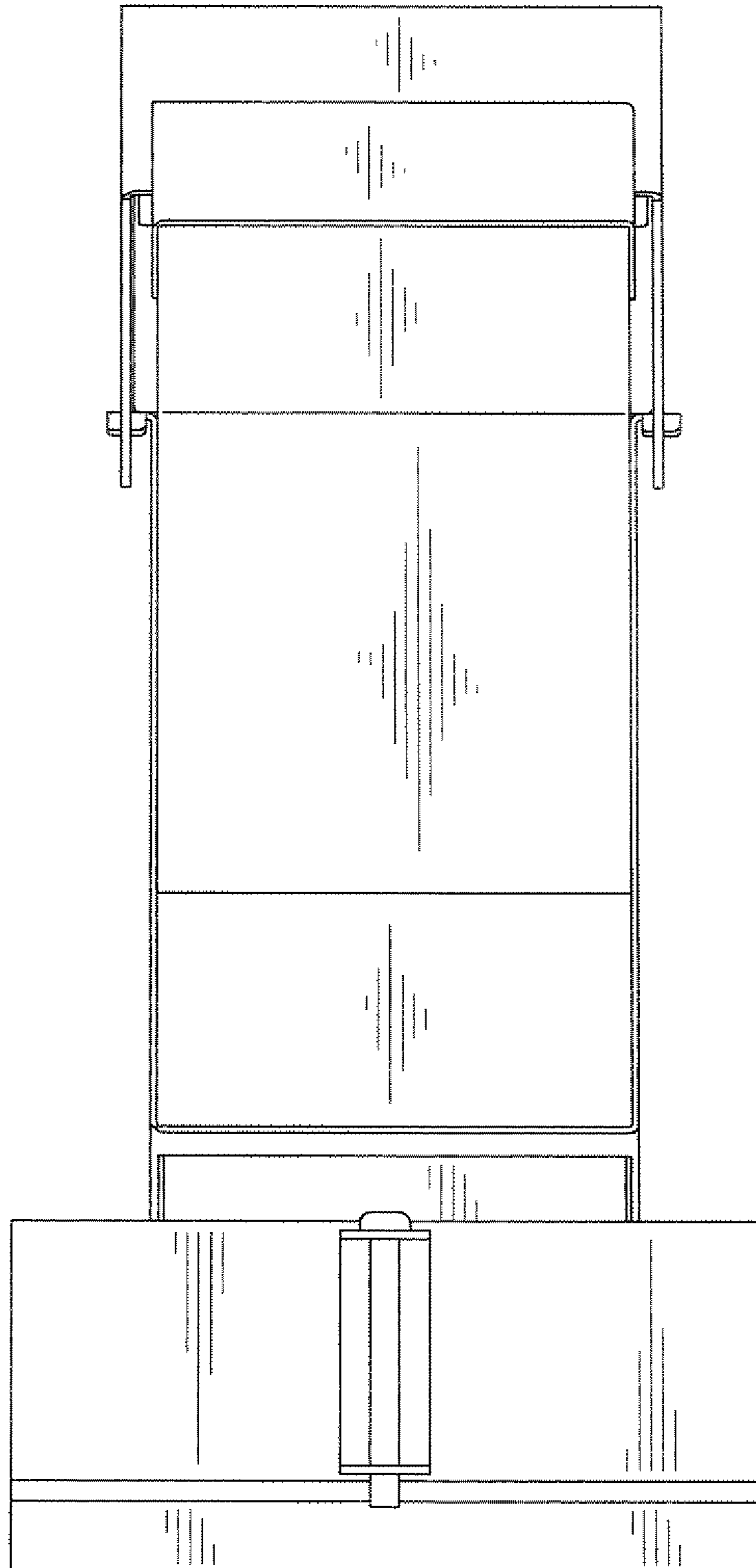

FIG. 6

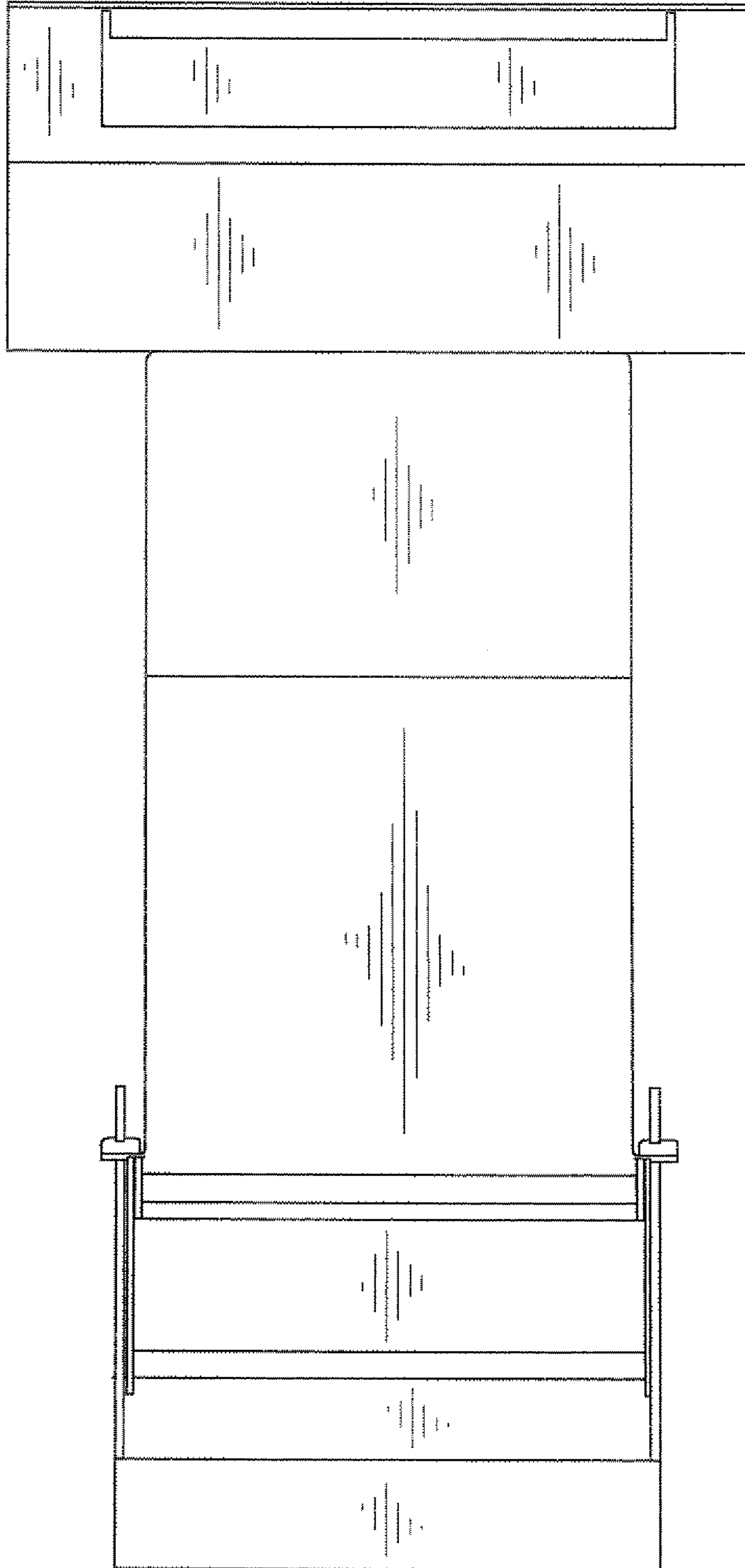

FIG. 7

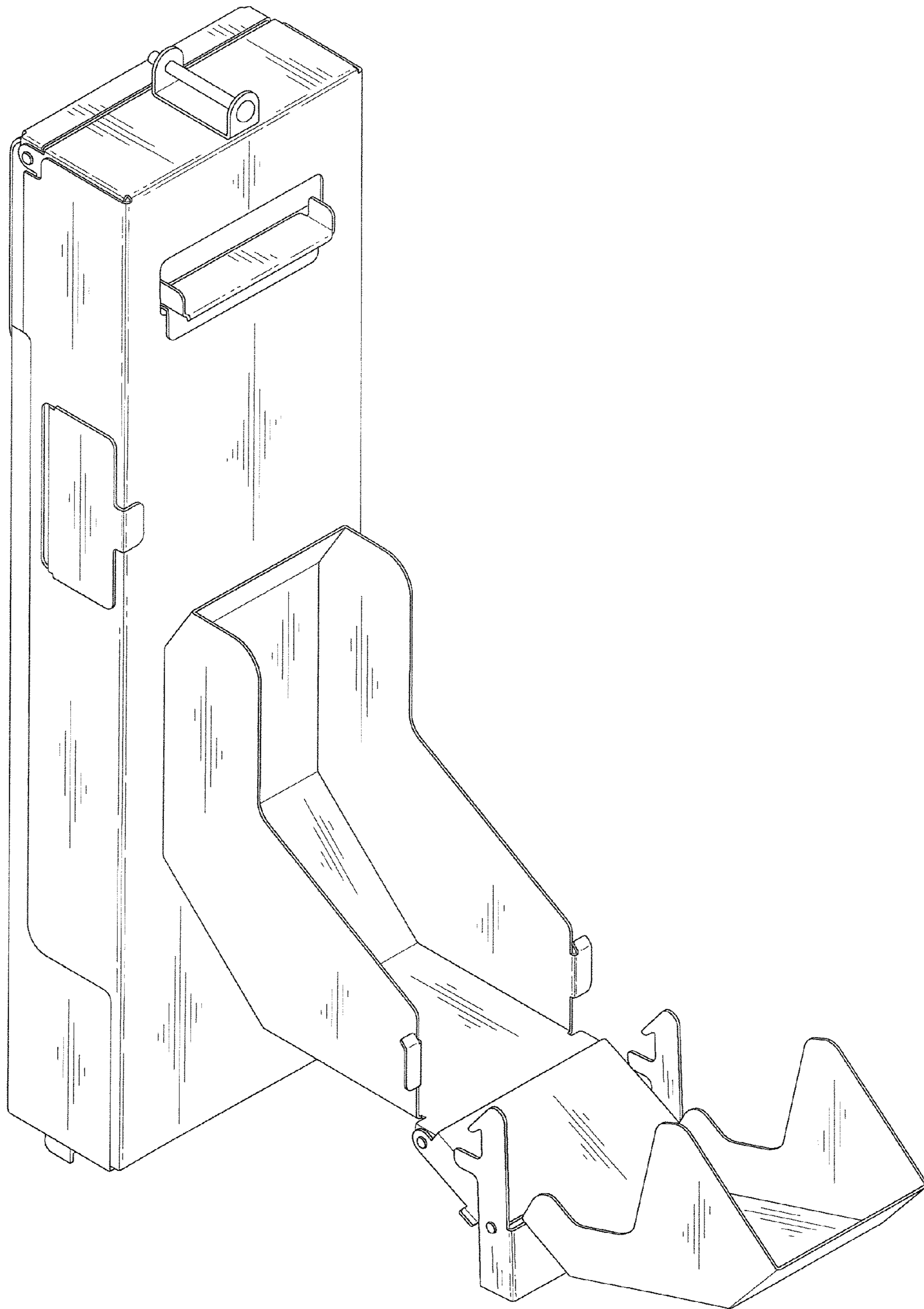

FIG. 8