



US00D574778S

(12) **United States Design Patent**
Szeto et al.

(10) **Patent No.:** **US D574,778 S**
(45) **Date of Patent:** **** Aug. 12, 2008**

(54) **DOMINO-MAHJONG STYLE CONNECTOR**

(75) Inventors: **Colin Szeto**, North York (CA); **Blair A. Birmingham**, Toronto (CA); **John R. Shaw**, Toronto (CA); **John Giordano**, Brampton (CA); **Miro Glisch**, Toronto (CA)

(73) Assignee: **ATI Technologies Inc.**, Markham, Ontario

(**) Term: **14 Years**

(21) Appl. No.: **29/237,320**

(22) Filed: **Aug. 31, 2005**

(51) **LOC (8) Cl.** **13-03**

(52) **U.S. Cl.** **D13/147**

(58) **Field of Classification Search** D13/133,
D13/146-147, 154-184, 199; 439/252, 378-381,
439/540.1, 541.5, 660, 668-669, 675-681

See application file for complete search history.

(56) **References Cited**

U.S. PATENT DOCUMENTS

3,078,438	A *	2/1963	Szentel	439/710
D220,569	S *	4/1971	De Carlo	D13/147
D234,771	S *	4/1975	Saunders	D13/147
D309,664	S *	7/1990	McGrane	D13/151
D320,381	S *	10/1991	McGrane	D13/147
D344,714	S *	3/1994	Kulbersh	D13/147
D346,150	S *	4/1994	Triantopoulos	D13/149
D377,782	S *	2/1997	Fillinger	D13/151

* cited by examiner

Primary Examiner—Daniel D Bui

(57) **CLAIM**

The ornamental design for a domino-mahjong style connector, as shown and described.

DESCRIPTION

FIG. 1 is a top, front and right side perspective view of the first embodiment of a domino-mahjong style connector, showing

our new design. The top, front and left side perspective view thereof is a mirror image thereto;

FIG. 2 is a bottom, front and right side perspective view thereof, the bottom, front and left side perspective view is a mirror image thereto;

FIG. 3 is a top plan view thereof;

FIG. 4 is a front elevation view thereof;

FIG. 5 is a bottom plan view thereof;

FIG. 6 is a rear elevation view thereof;

FIG. 7 is a right side elevation view thereof;

FIG. 8 is a left side elevation view thereof;

FIG. 9 is a top, front and right side perspective view of the second embodiment of a domino-mahjong style connector, showing our new design. The top, front and left side perspective view thereof is a mirror image thereto;

FIG. 10 is a bottom, front and right side perspective view thereof, the bottom, front and left side perspective view is a mirror image thereto;

FIG. 11 is a top plan view thereof;

FIG. 12 is a front elevation view thereof;

FIG. 13 is a bottom plan view thereof;

FIG. 14 is a rear elevation view thereof;

FIG. 15 is a right side elevation view thereof;

FIG. 16 is a left side elevation view thereof;

FIG. 17 is a top, front and right side perspective view of the third embodiment of a domino-mahjong style connector, showing our new design. The top, front and left side perspective view thereof is a mirror image thereto;

FIG. 18 is a bottom, front and right side perspective view thereof, the bottom, front and left side perspective view is a mirror image thereto;

FIG. 19 is a top plan view thereof;

FIG. 20 is a front elevation view thereof;

FIG. 21 is a bottom plan view thereof;

FIG. 22 is a rear elevation view thereof;

FIG. 23 is a right side elevation view thereof;

FIG. 24 is a left side elevation view thereof;

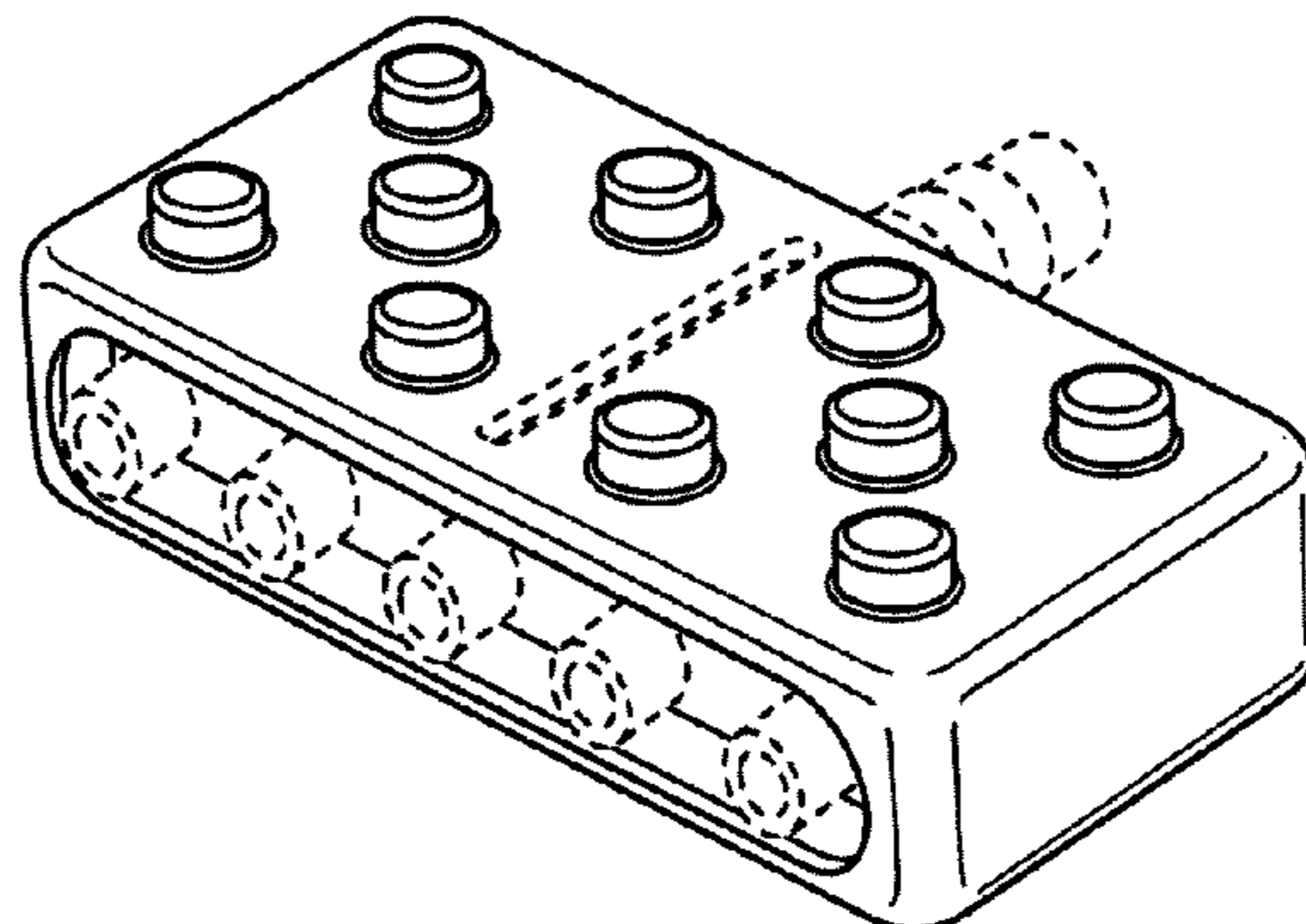

FIG. 91 is a top plan view thereof;
FIG. 92 is a front elevation view thereof;
FIG. 93 is a bottom plan view thereof;
FIG. 94 is a rear elevation view thereof;
FIG. 95 is a right side elevation view thereof;
FIG. 96 is a left side elevation view thereof;
FIG. 97 is a top, front and right side perspective view of the thirteenth embodiment of a DOMINO-MAHJONG STYLE CONNECTOR, showing our new design. The top, front and left side perspective view thereof is a mirror image thereto;
FIG. 98 is a bottom, front and right side perspective view thereof, the bottom, front and left side perspective view is a mirror image thereto;
FIG. 99 is a top plan view thereof;
FIG. 100 is a front elevation view thereof;
FIG. 101 is a bottom plan view thereof;
FIG. 102 is a rear elevation view thereof;
FIG. 103 is a right side elevation view thereof; and
FIG. 104 is a left side elevation view thereof;
FIG. 105 is a top, front and right side perspective view of the fourteenth embodiment of a DOMINO-MAHJONG STYLE CONNECTOR, showing our new design. The top, front and left side perspective view thereof is a mirror image thereto;
FIG. 106 is a bottom, front and right side perspective view thereof, the bottom, front and left side perspective view is a mirror image thereto;

FIG. 107 is a top plan view thereof;
FIG. 108 is a front elevation view thereof;
FIG. 109 is a bottom plan view thereof;
FIG. 110 is a rear elevation view thereof;
FIG. 111 is a right side elevation view thereof; and
FIG. 112 is a left side elevation view thereof;
FIG. 113 is a top, front and right side perspective view of the fifteenth embodiment of a DOMINO-MAHJONG STYLE CONNECTOR, showing our new design. The top, front and left side perspective view thereof is a mirror image thereto;
FIG. 114 is a bottom, front and right side perspective view thereof, the bottom, front and left side perspective view is a mirror image thereto;
FIG. 115 is a top plan view thereof;
FIG. 116 is a front elevation view thereof;
FIG. 117 is a bottom plan view thereof;
FIG. 118 is a rear elevation view thereof;
FIG. 119 is a right side elevation view thereof; and,
FIG. 120 is a left side elevation view thereof.
The broken line portion of the figure drawings is included to show unclaimed subject matter only and forms no part of the claimed design.

1 Claim, 30 Drawing Sheets

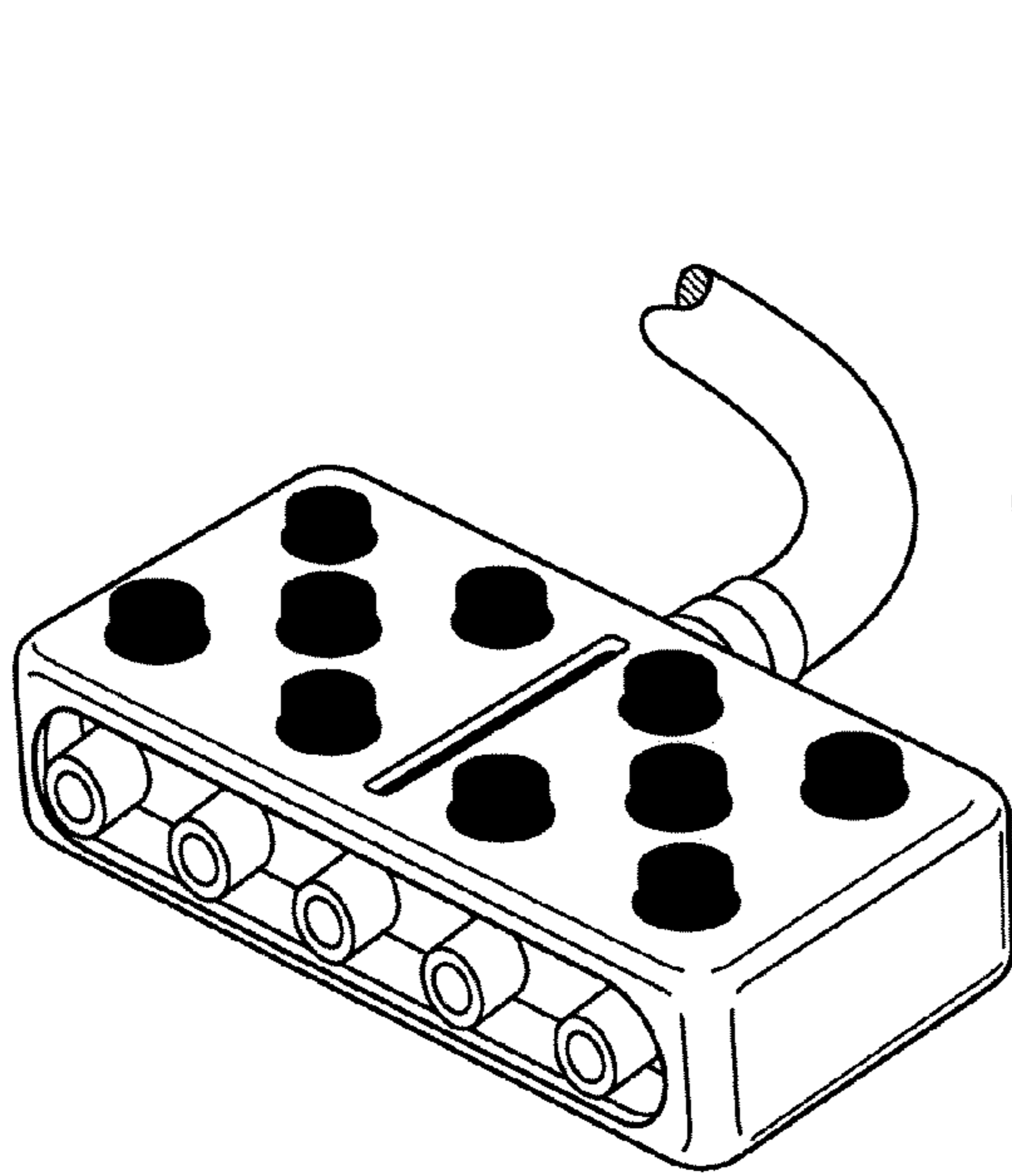

FIG. 1

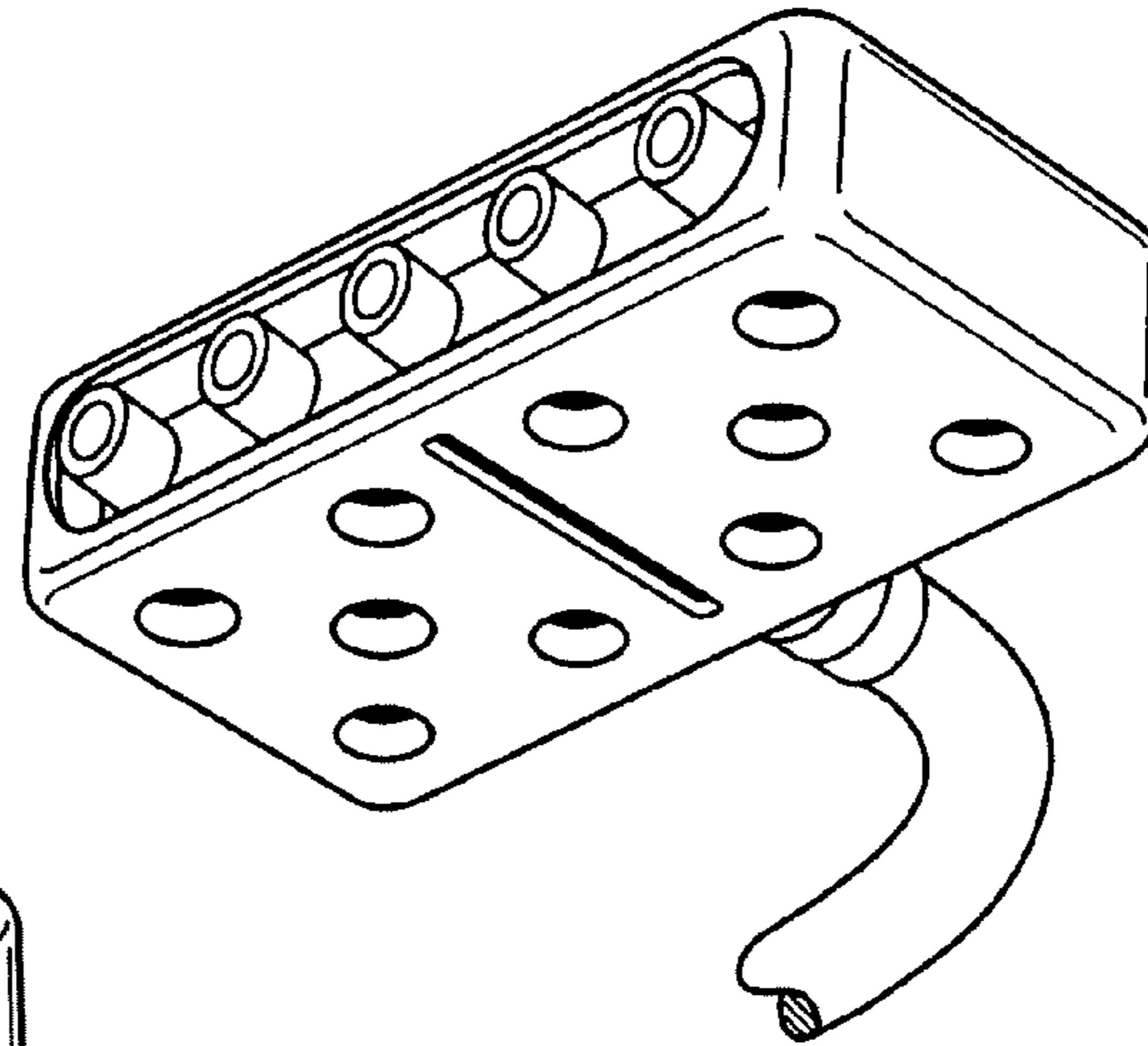

FIG. 2

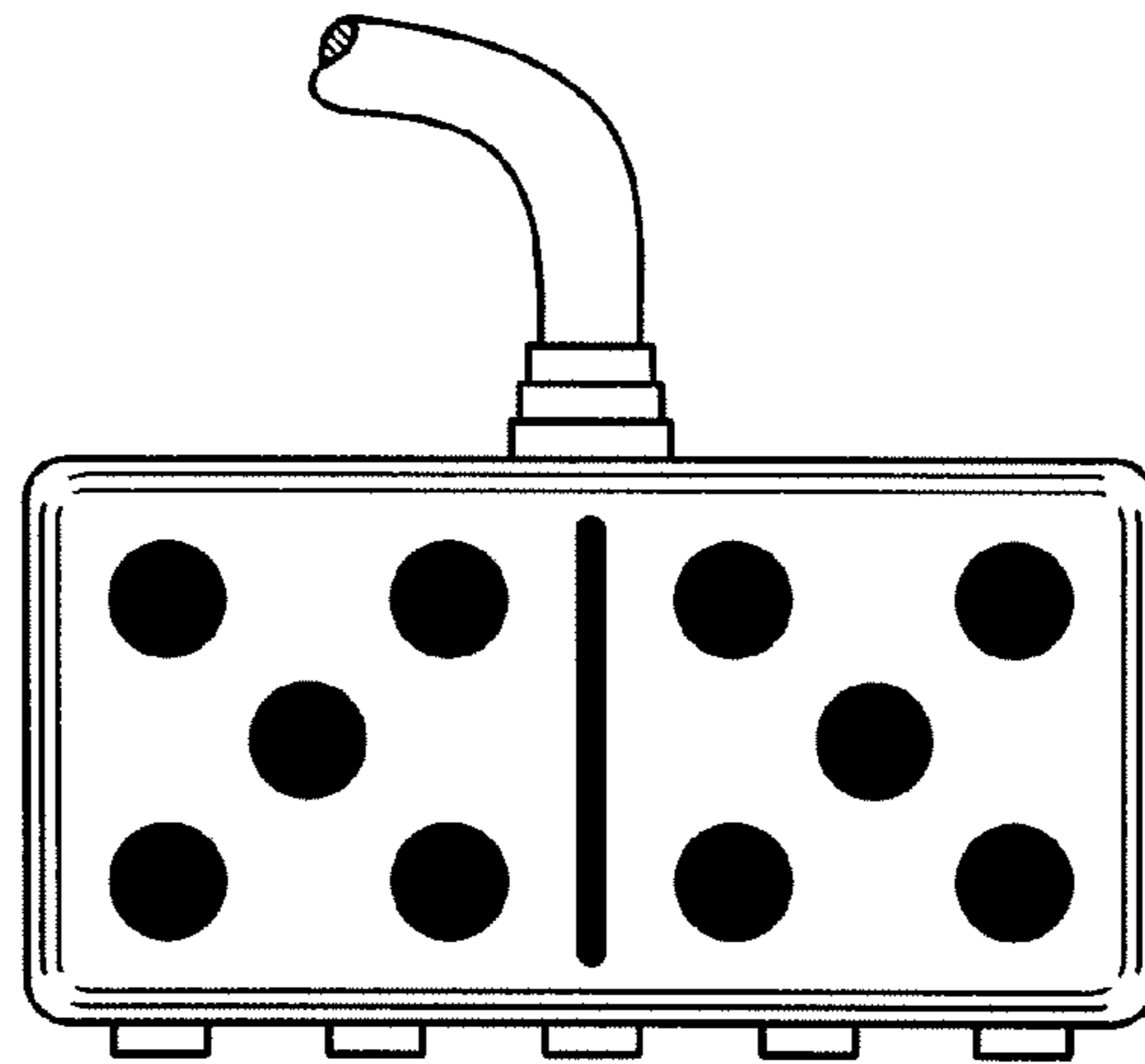

FIG. 3

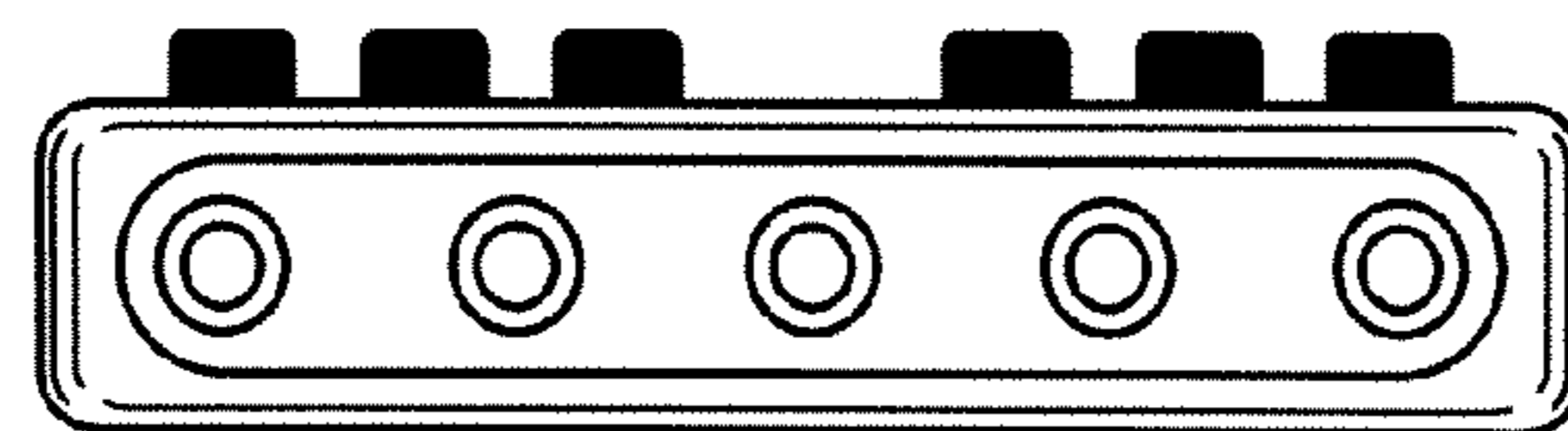

FIG. 4

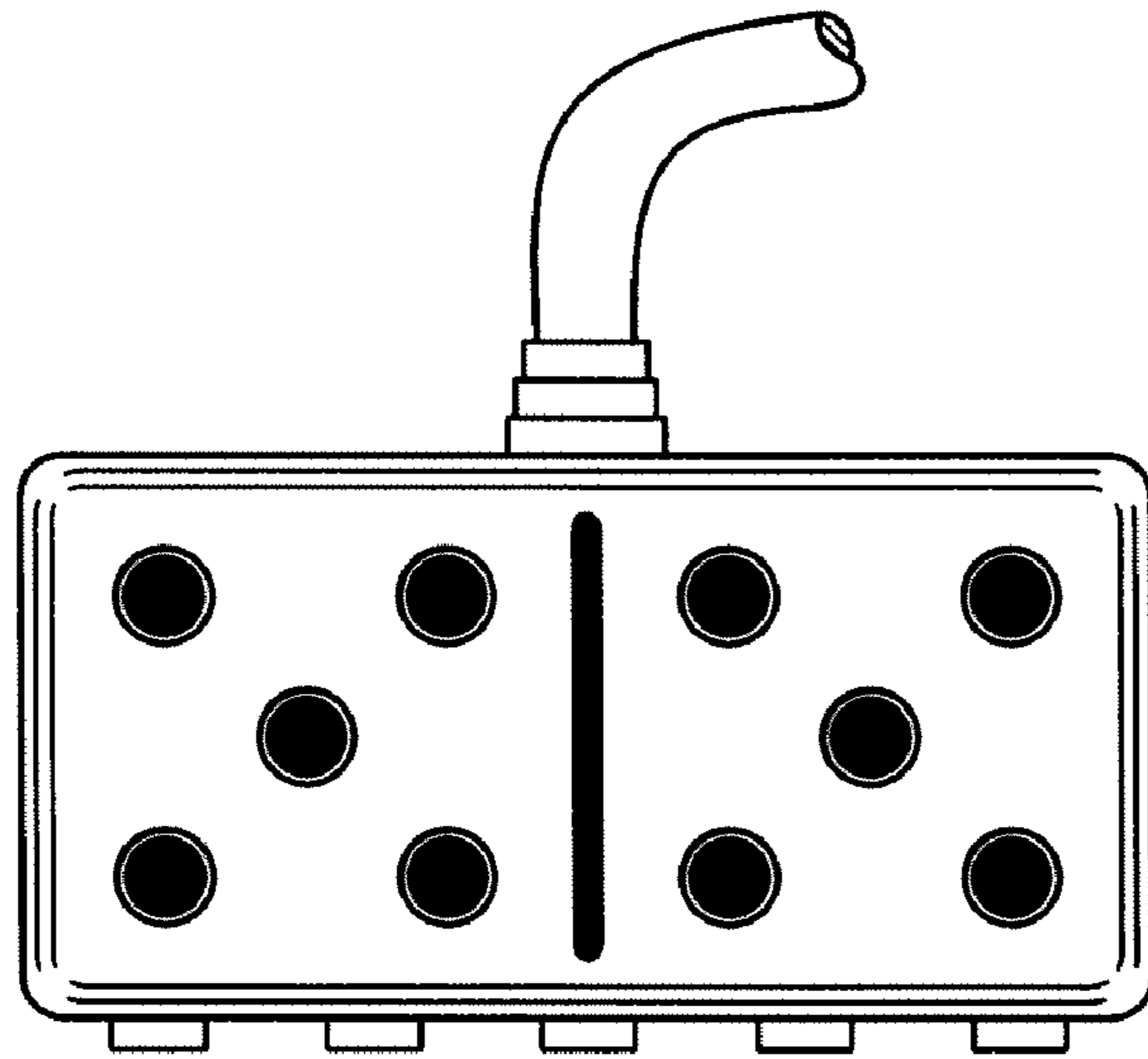

FIG. 5

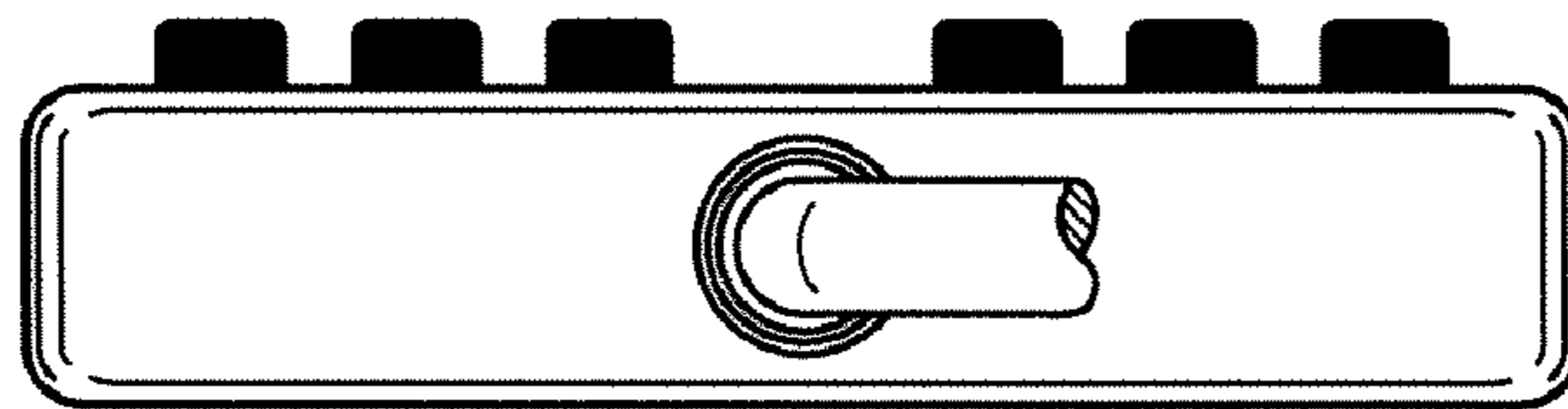

FIG. 6

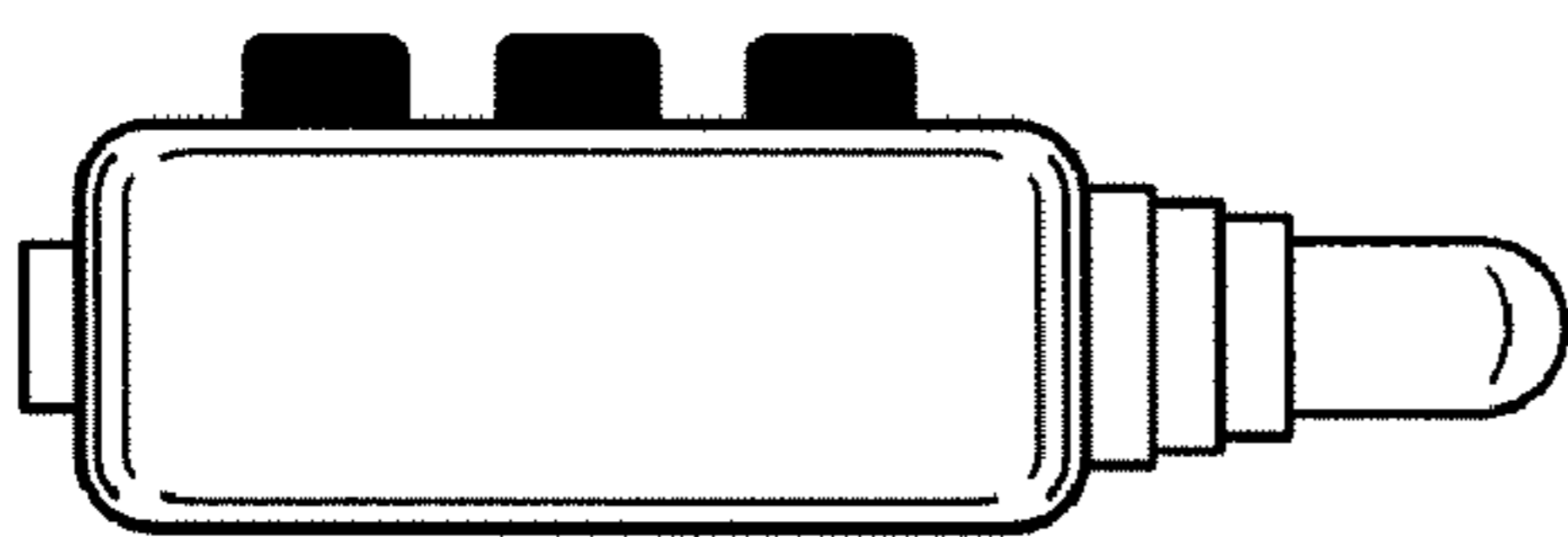

FIG. 7

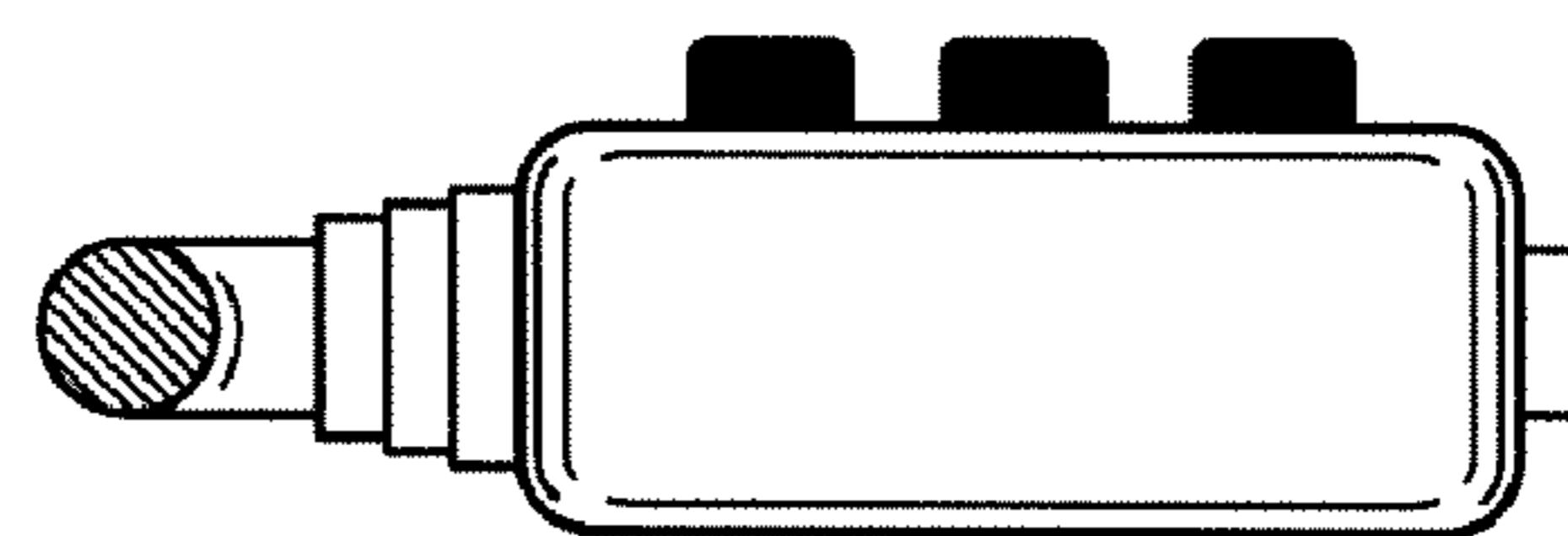

FIG. 8

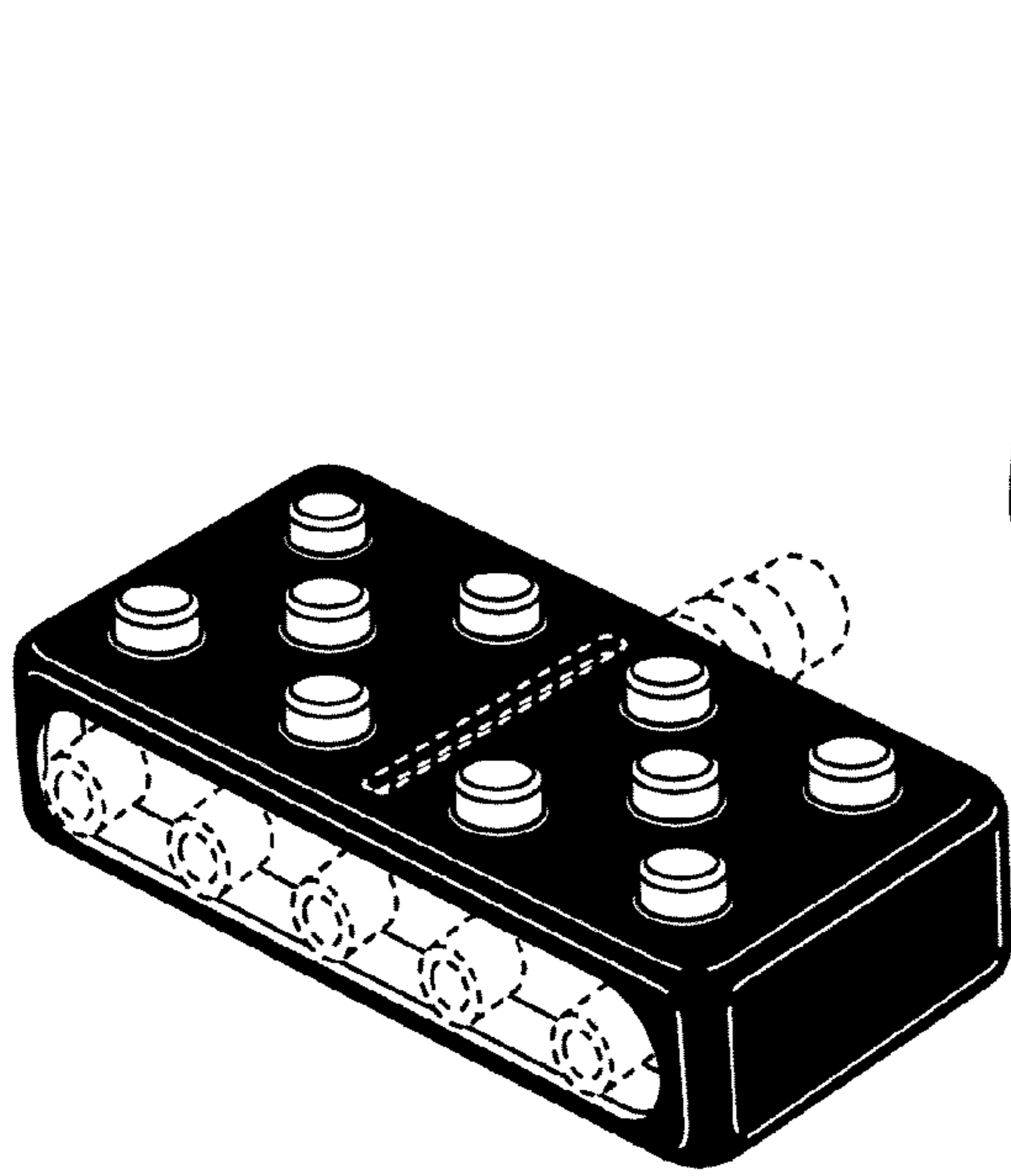

FIG. 9

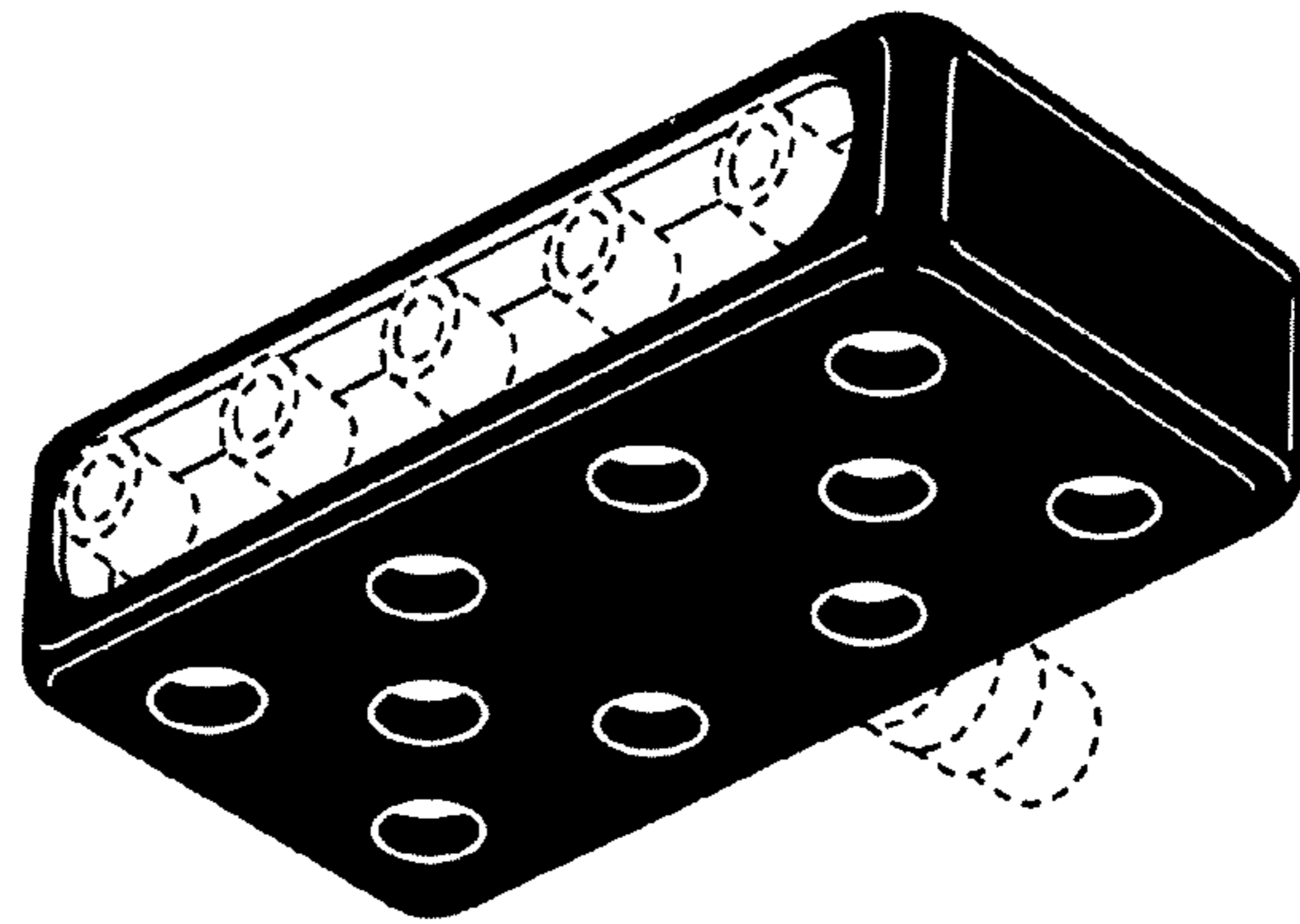

FIG. 10

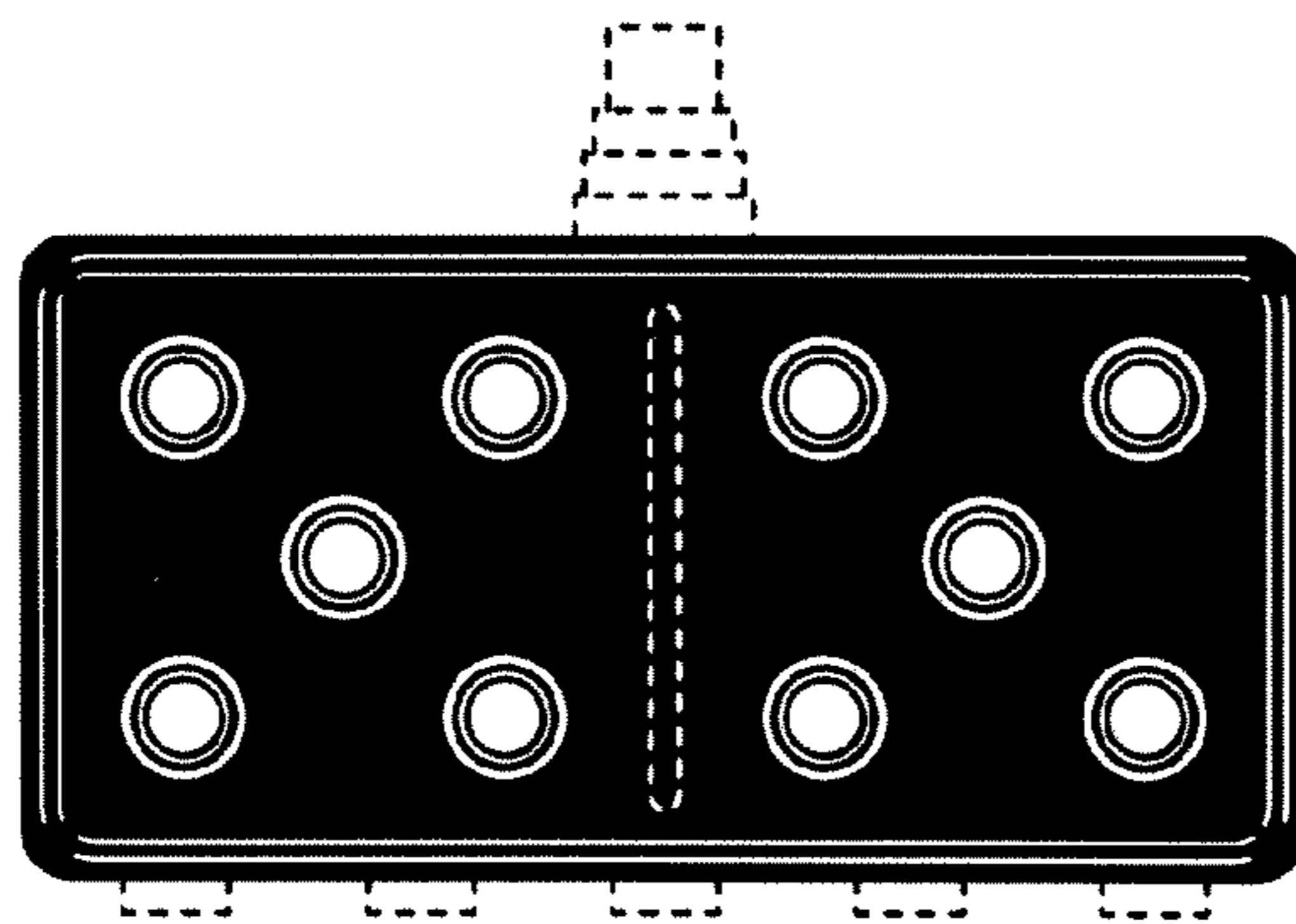

FIG. 11

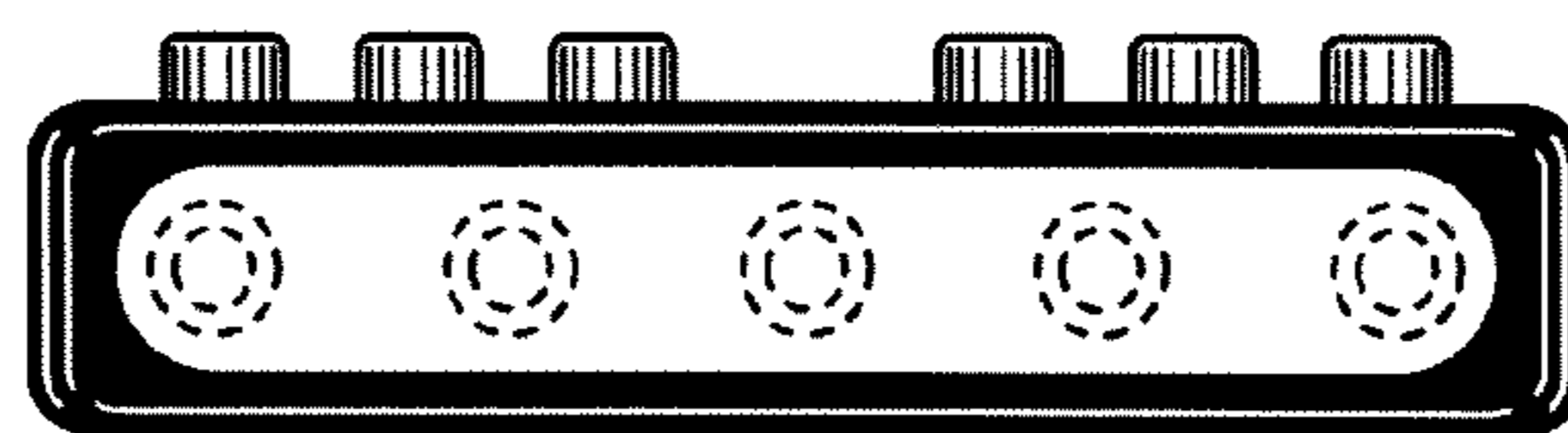

FIG. 12

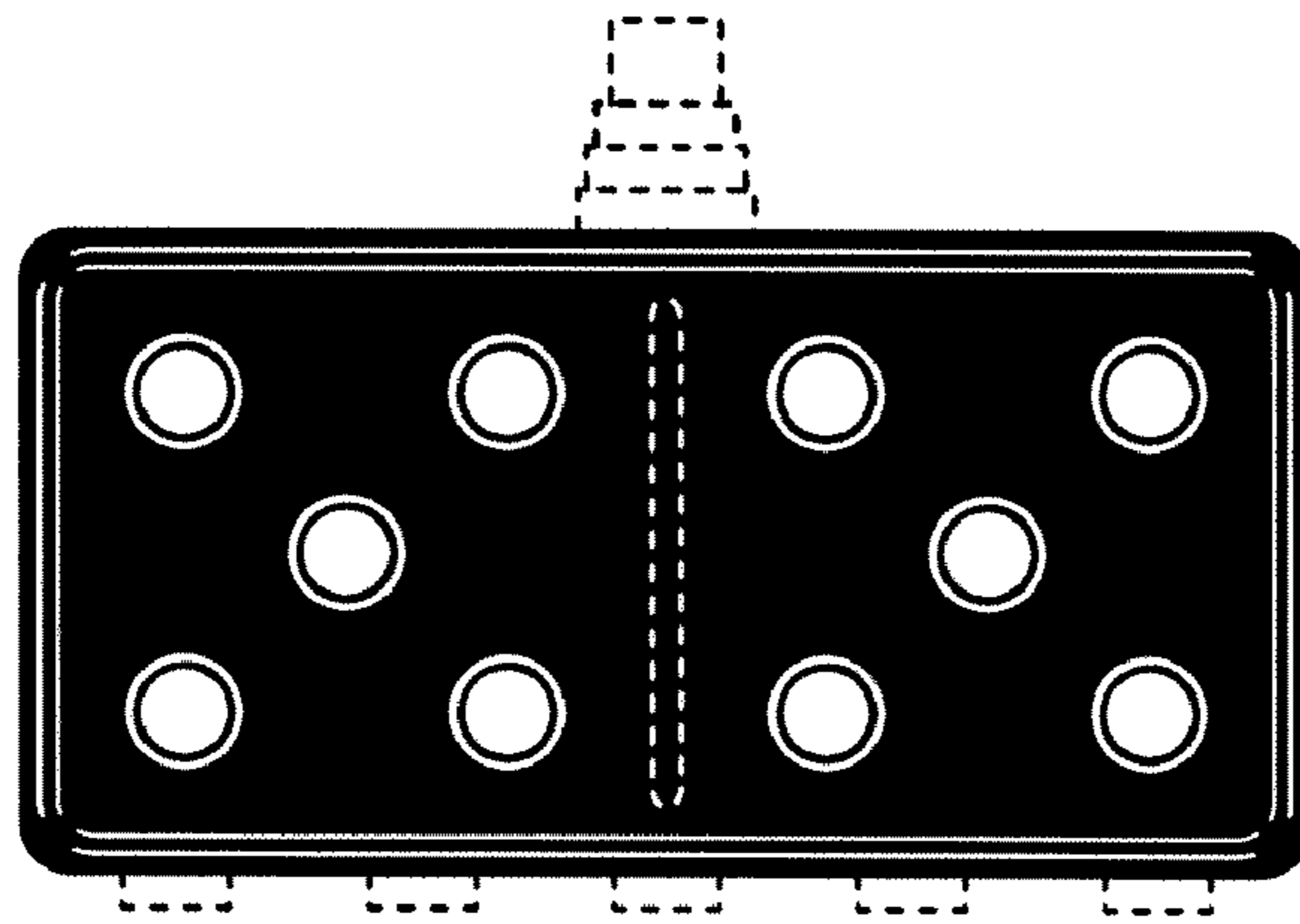

FIG. 13

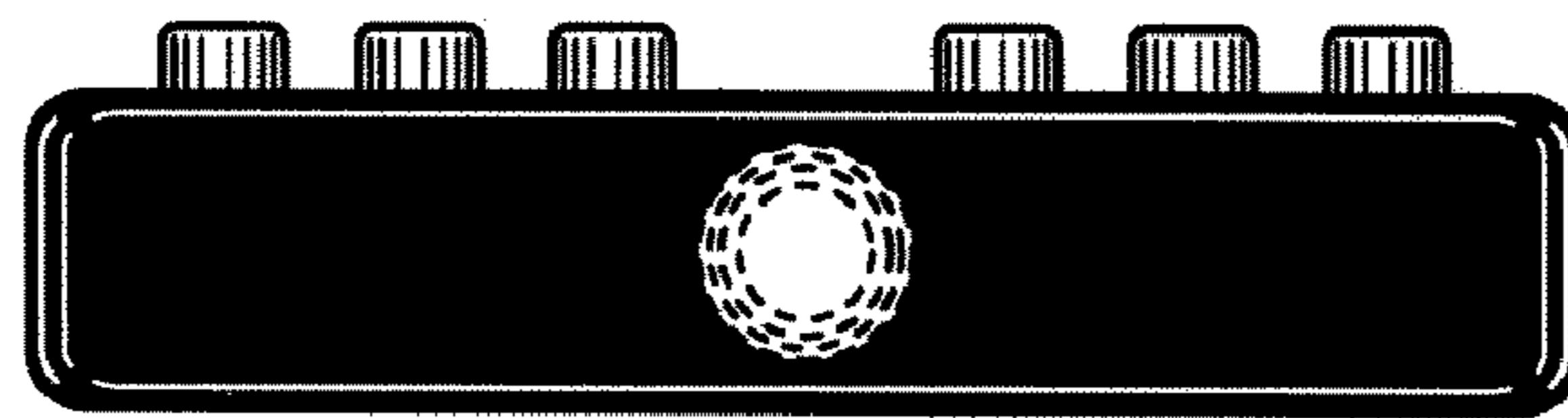

FIG. 14

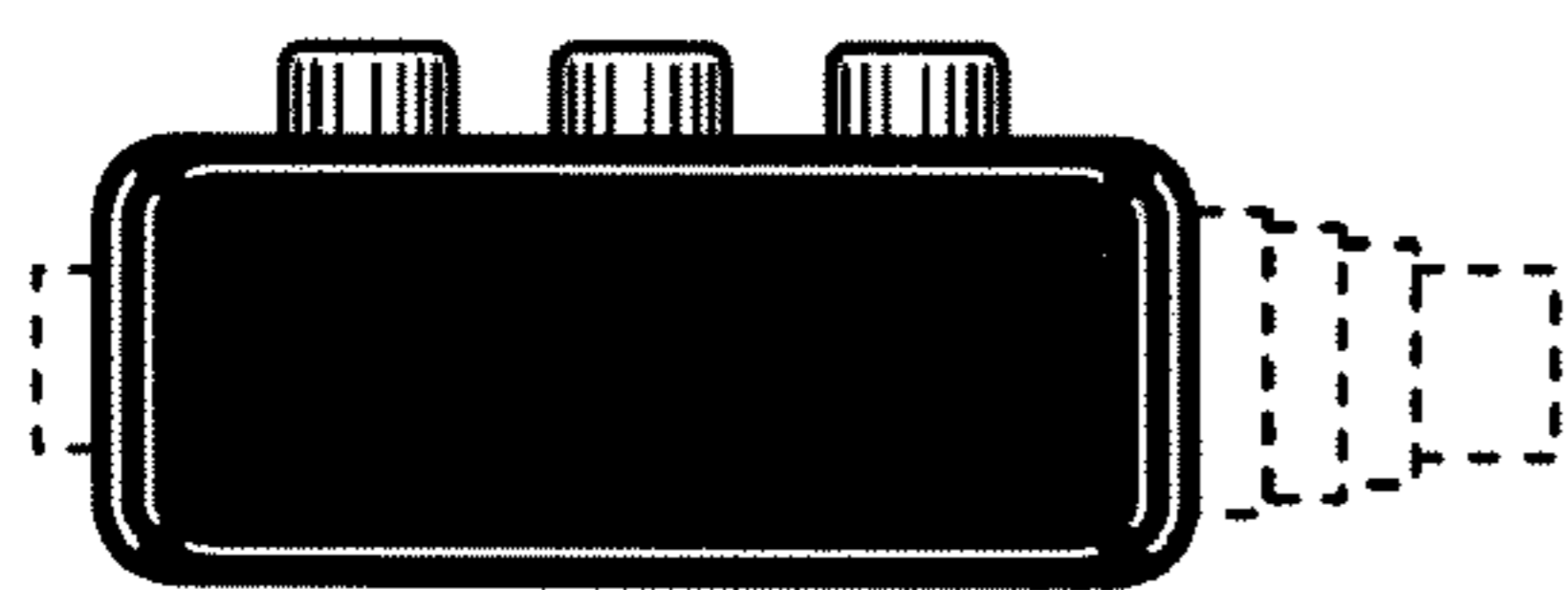

FIG. 15

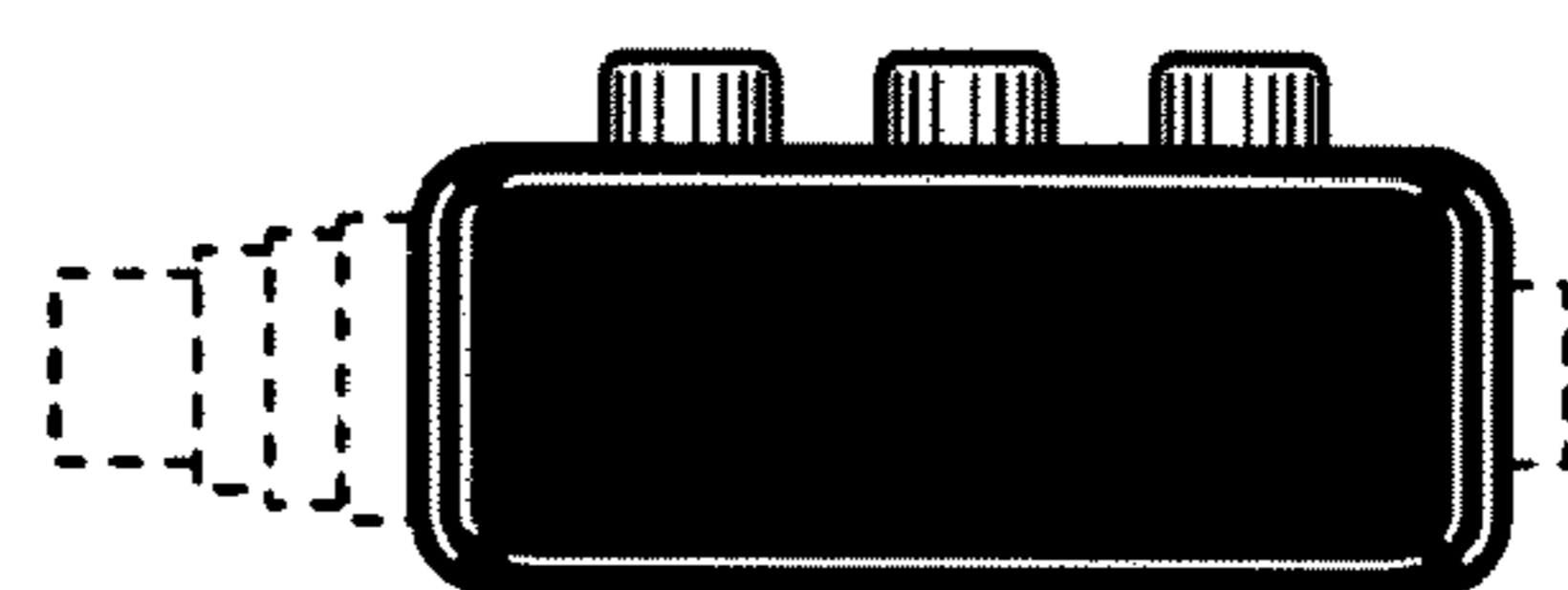

FIG. 16

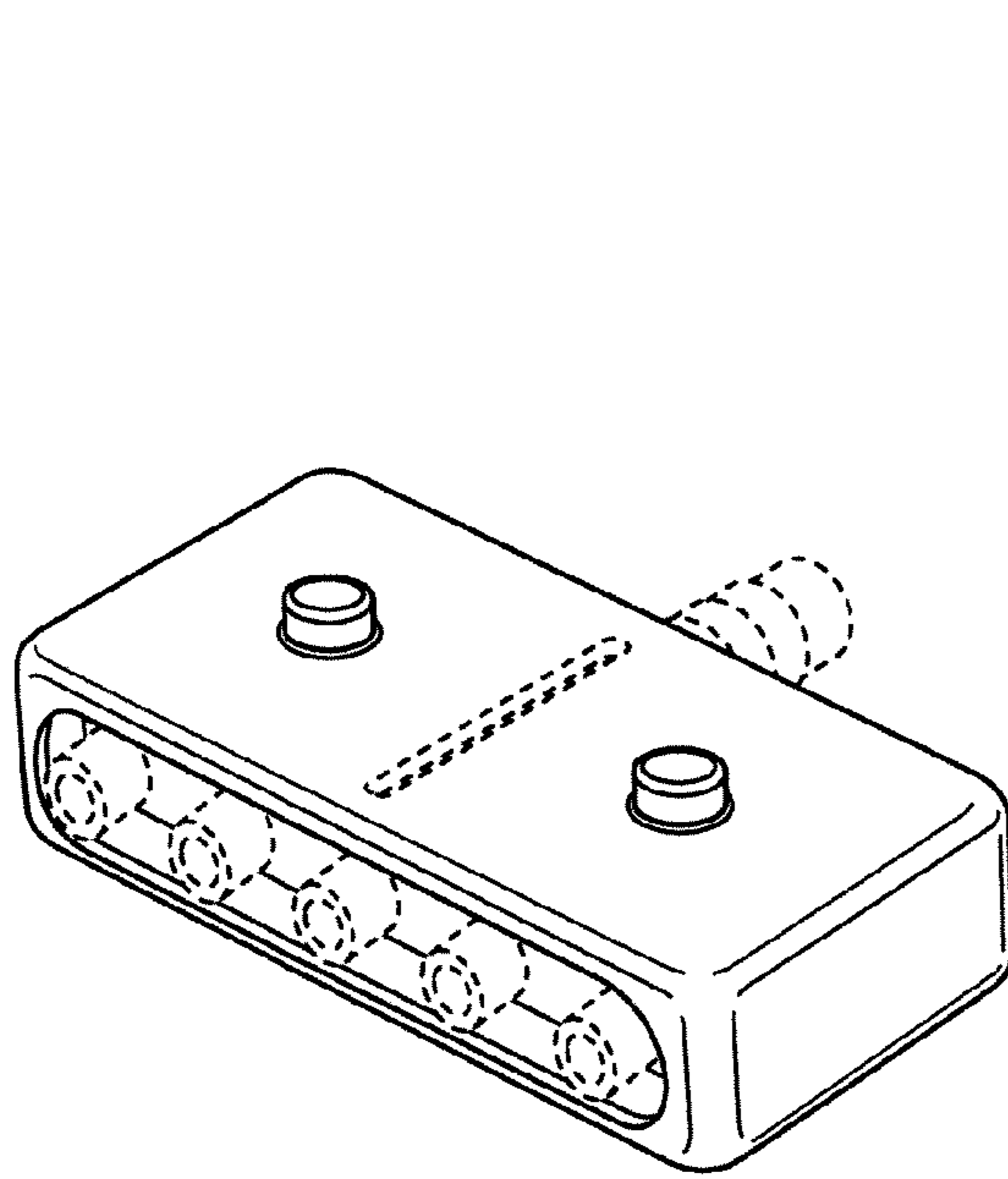

FIG. 17

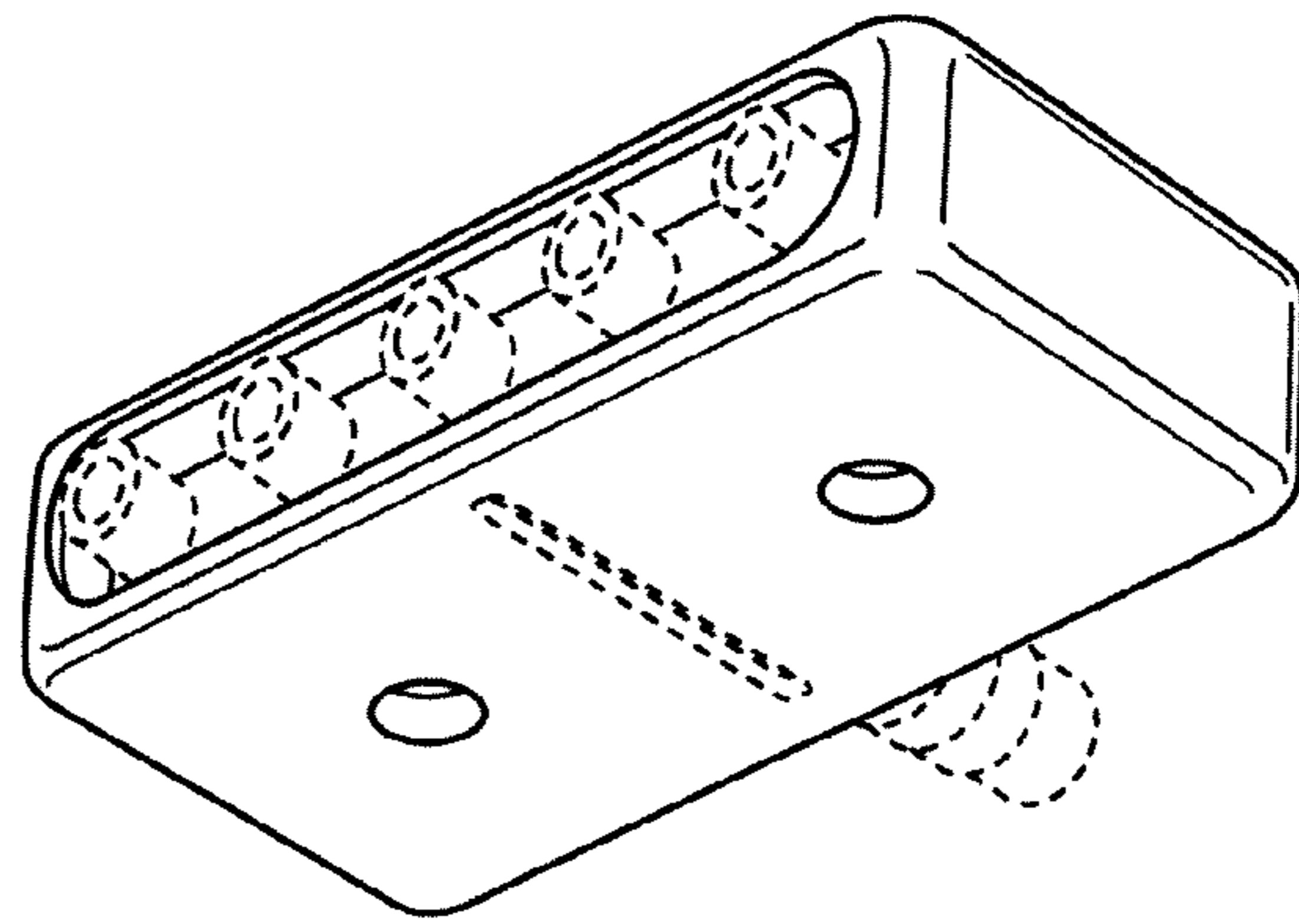

FIG. 18

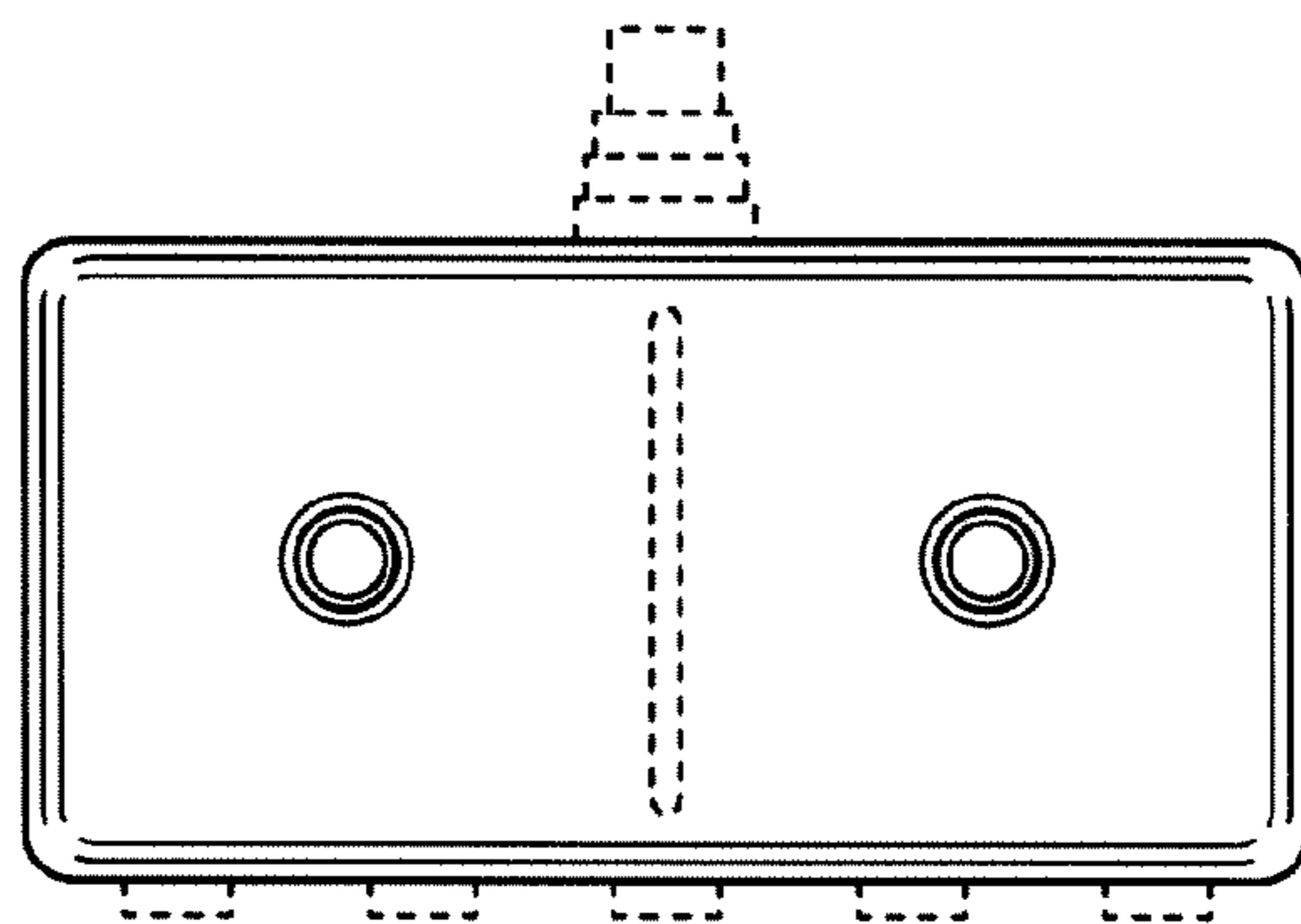

FIG. 19

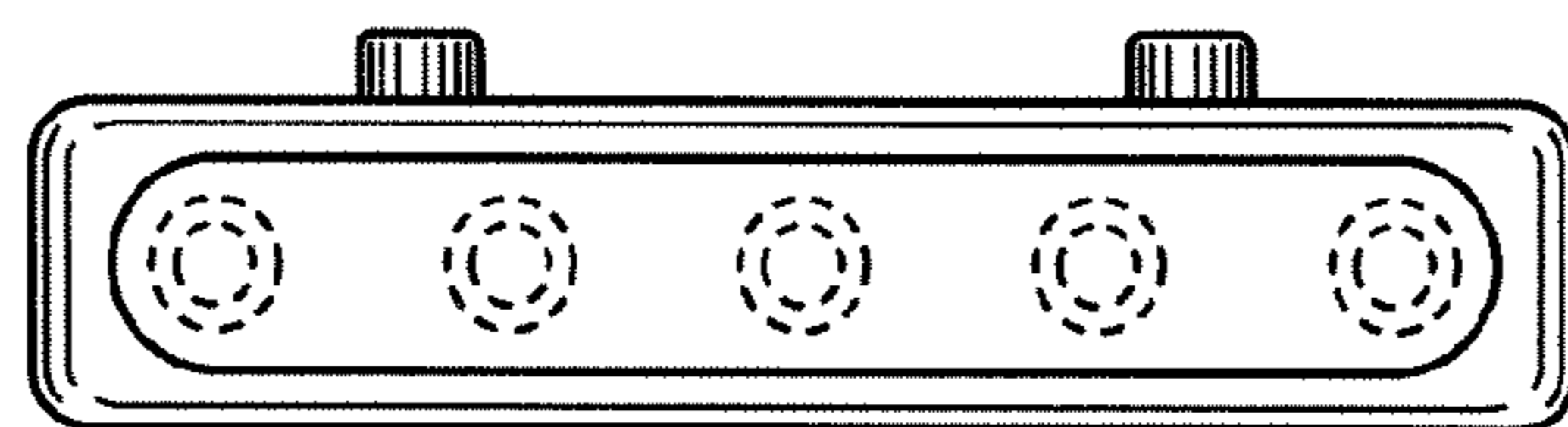

FIG. 20

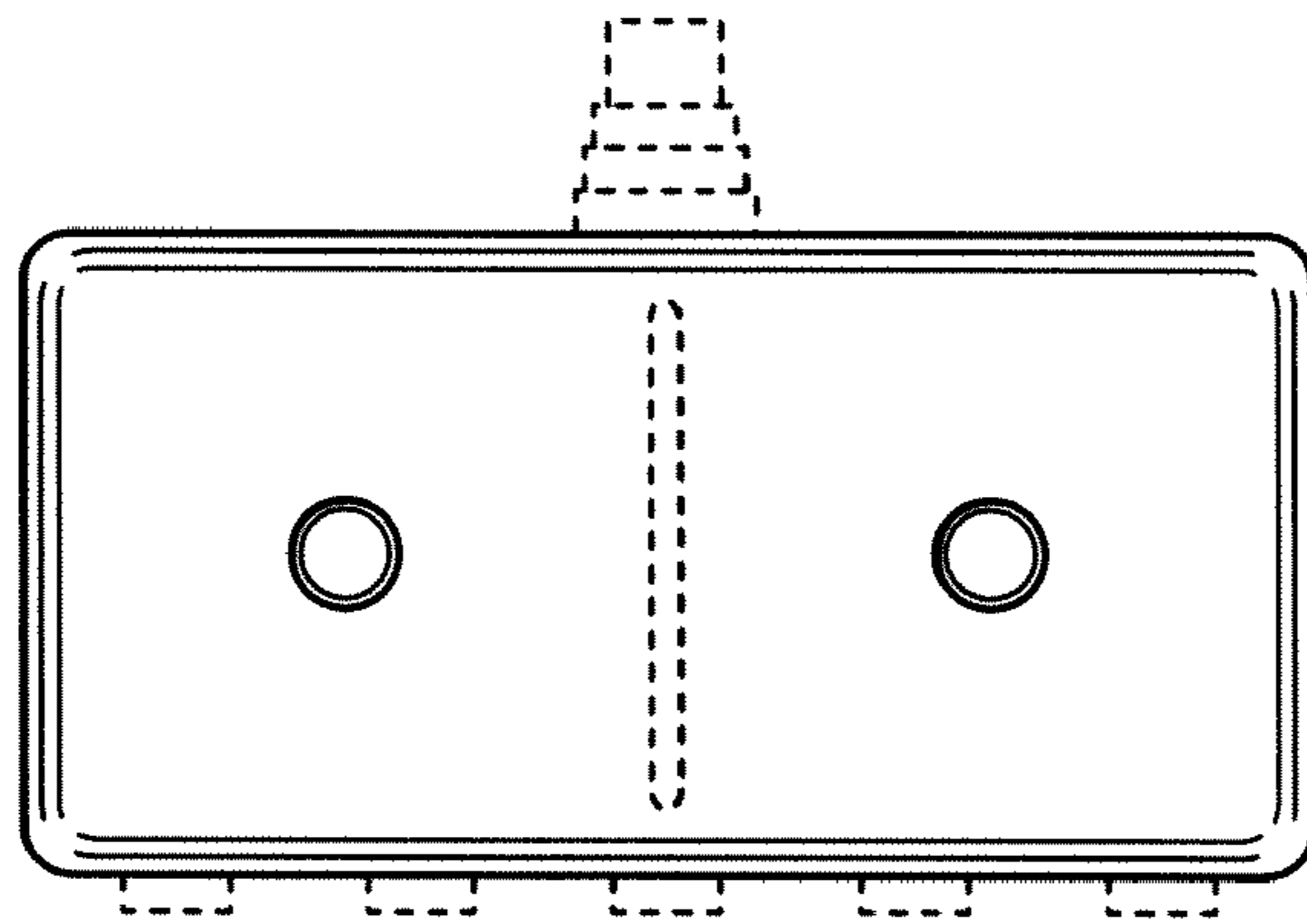

FIG. 21

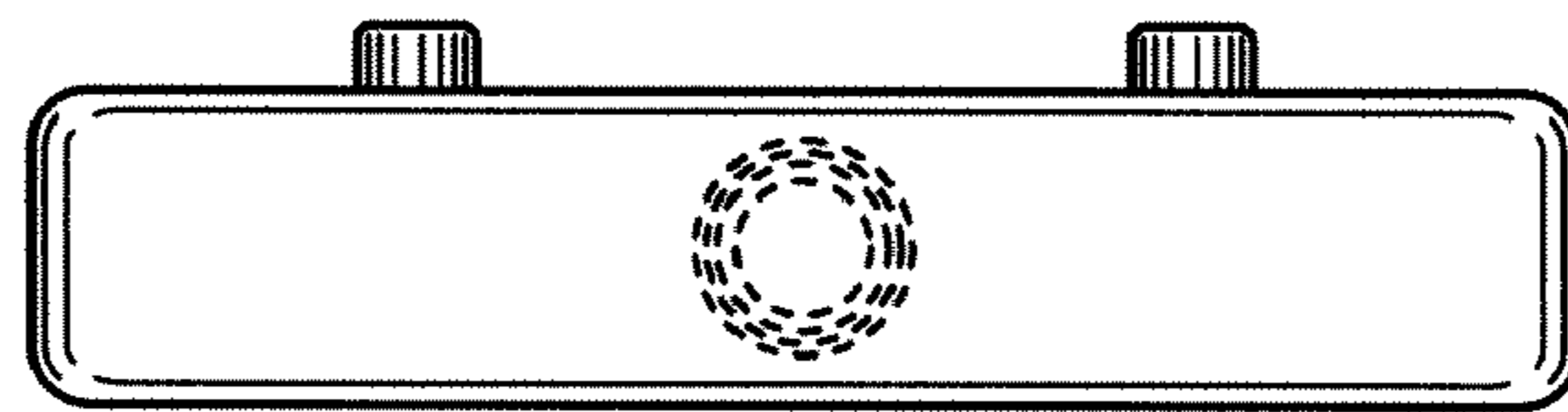

FIG. 22

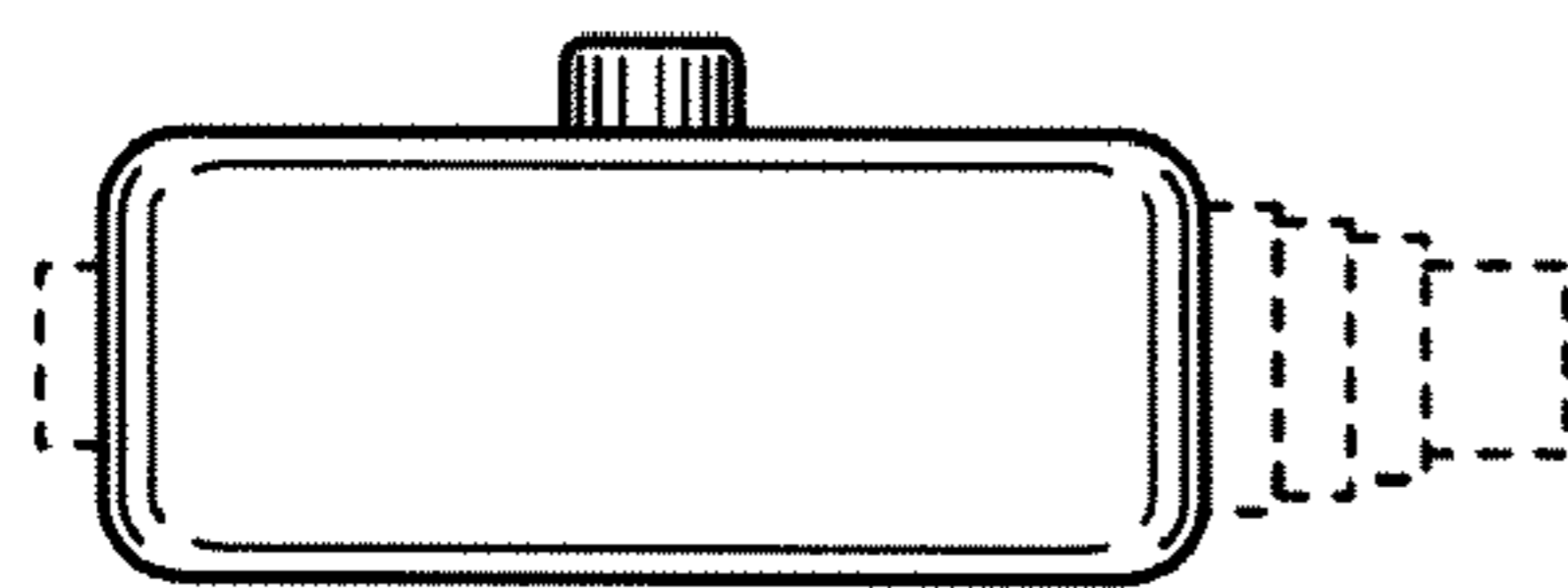

FIG. 23

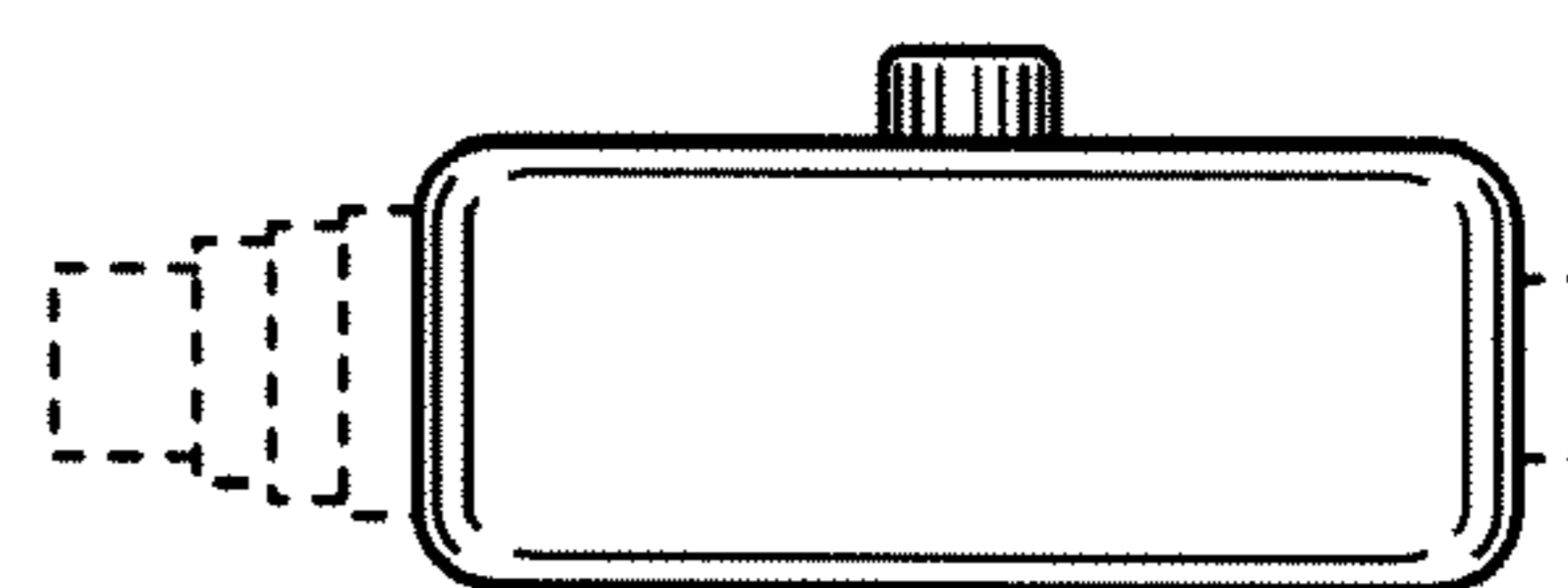

FIG. 24

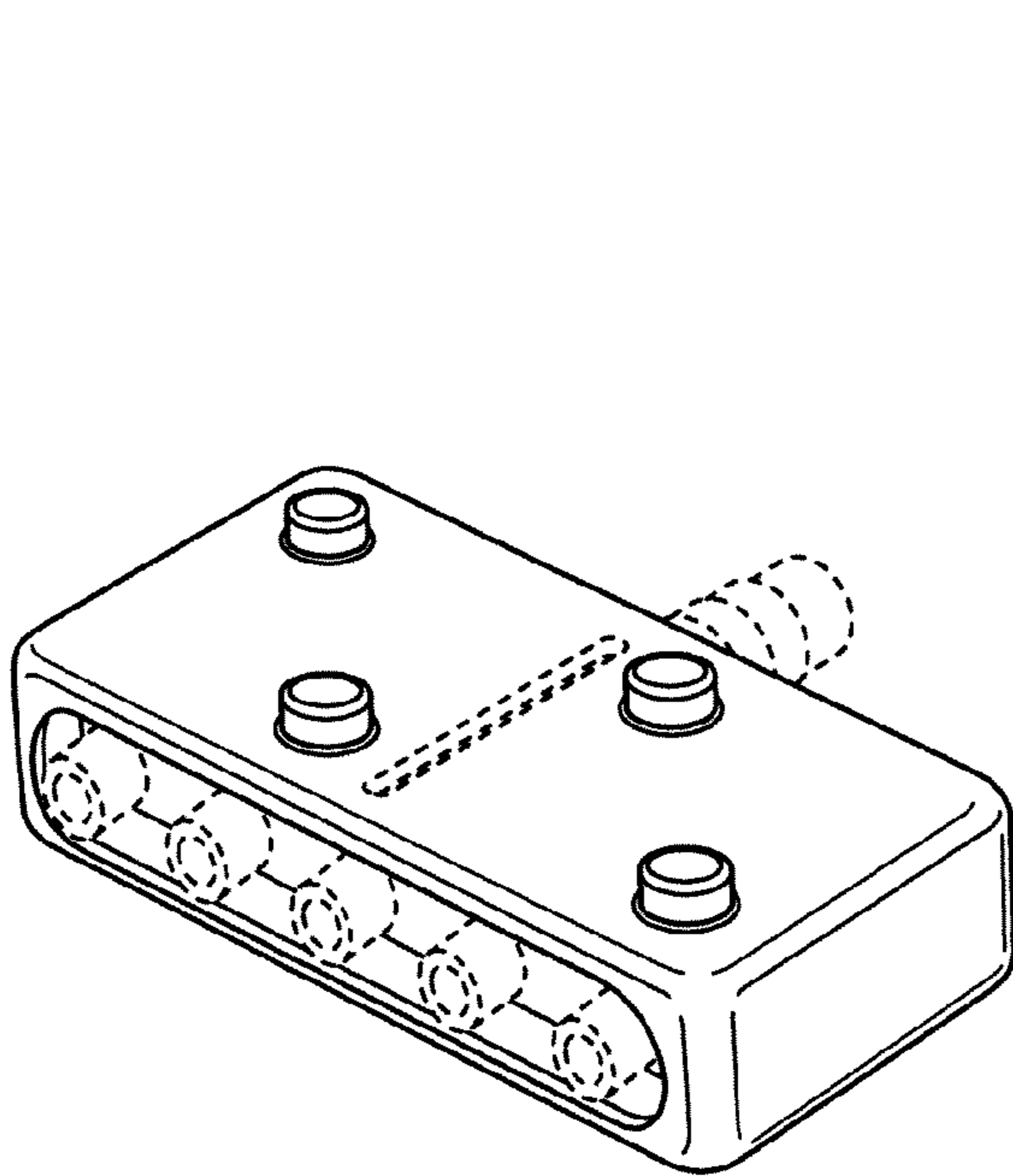

FIG. 25

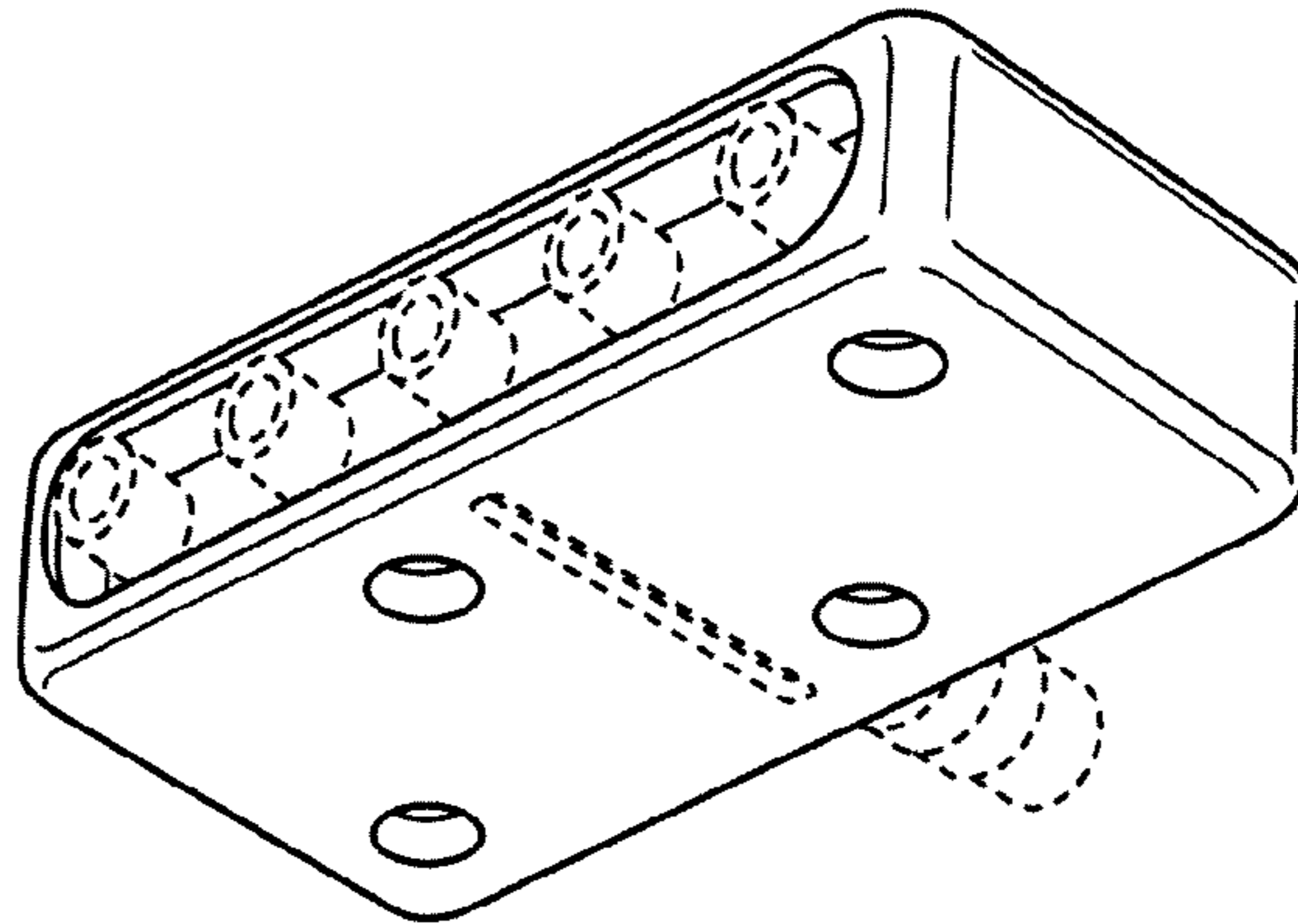

FIG. 26

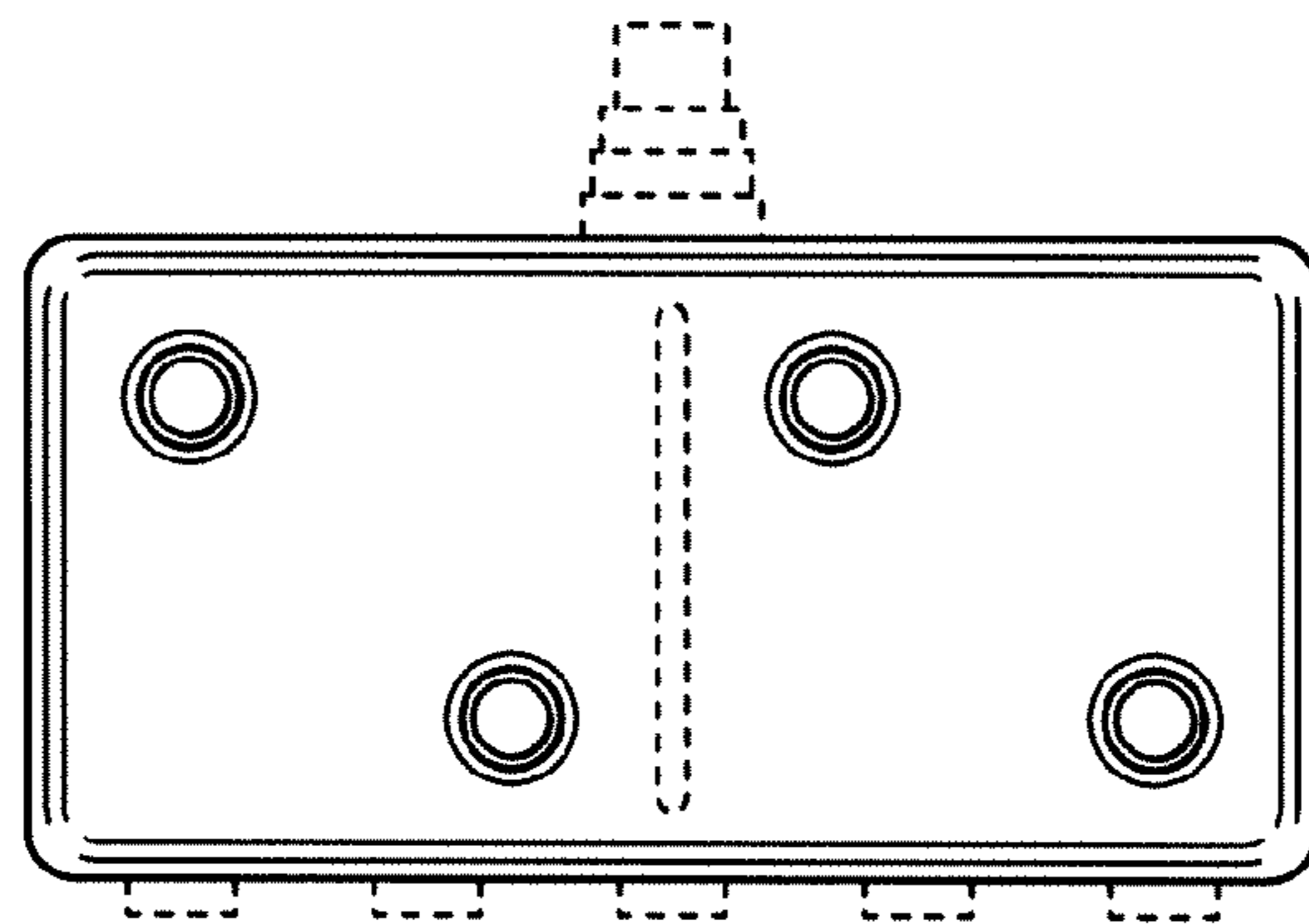

FIG. 27

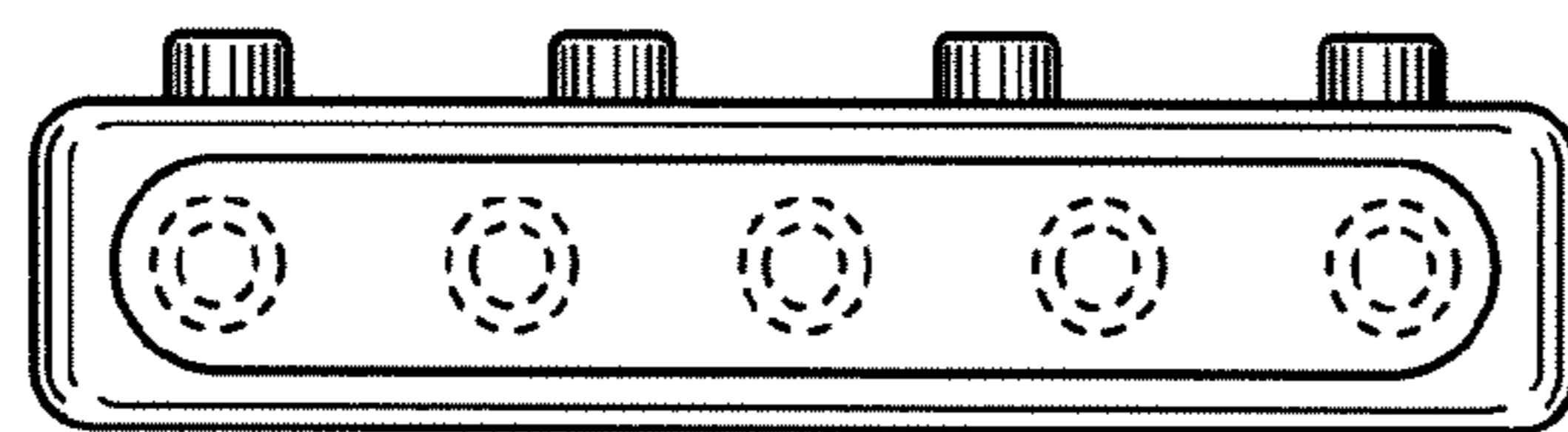

FIG. 28

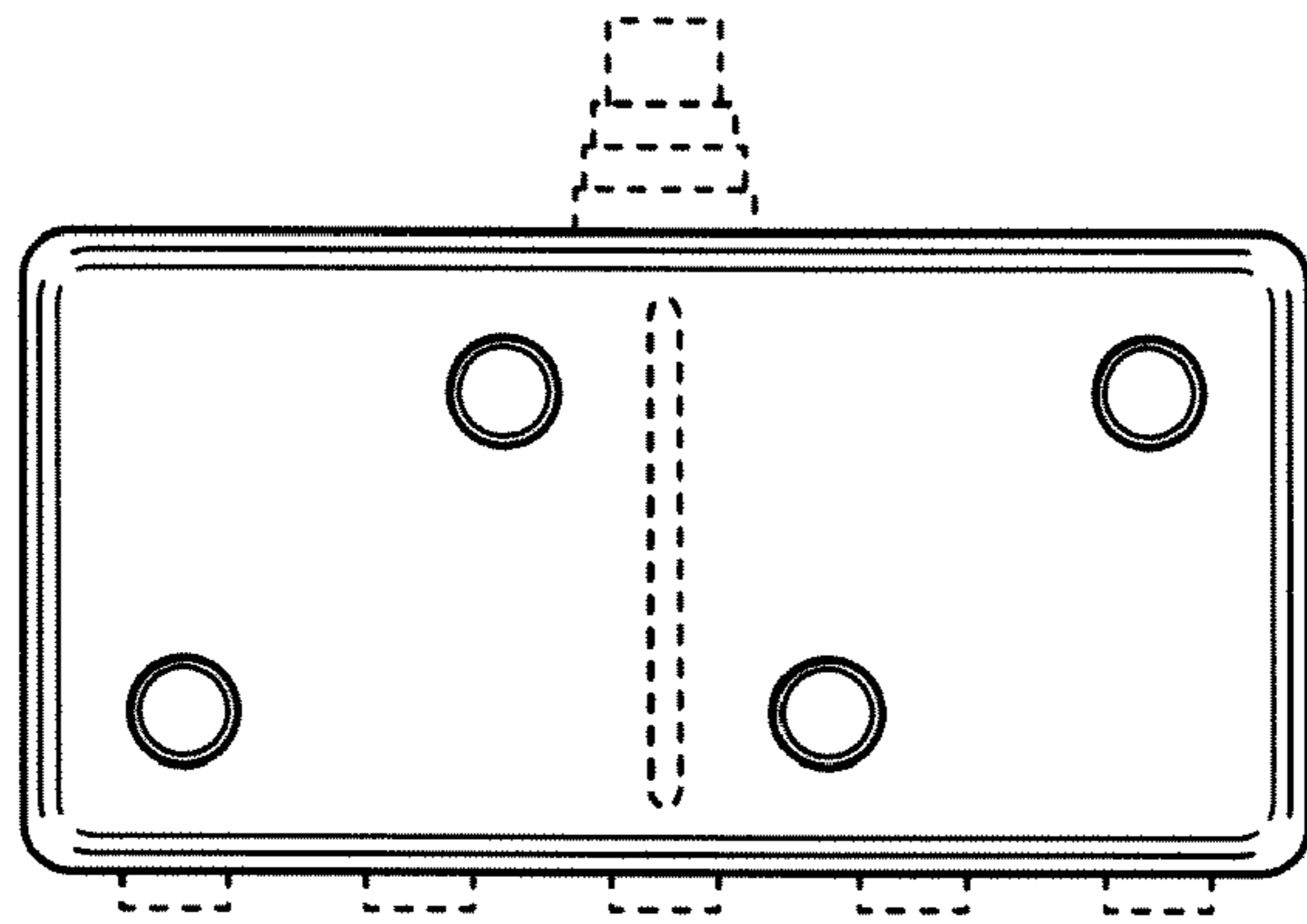

FIG. 29

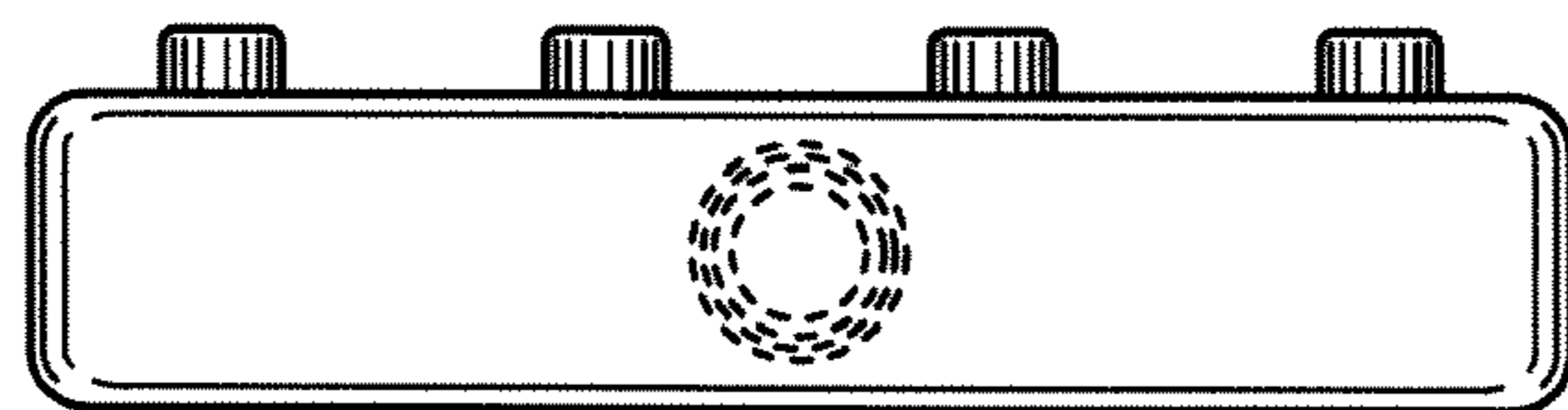

FIG. 30

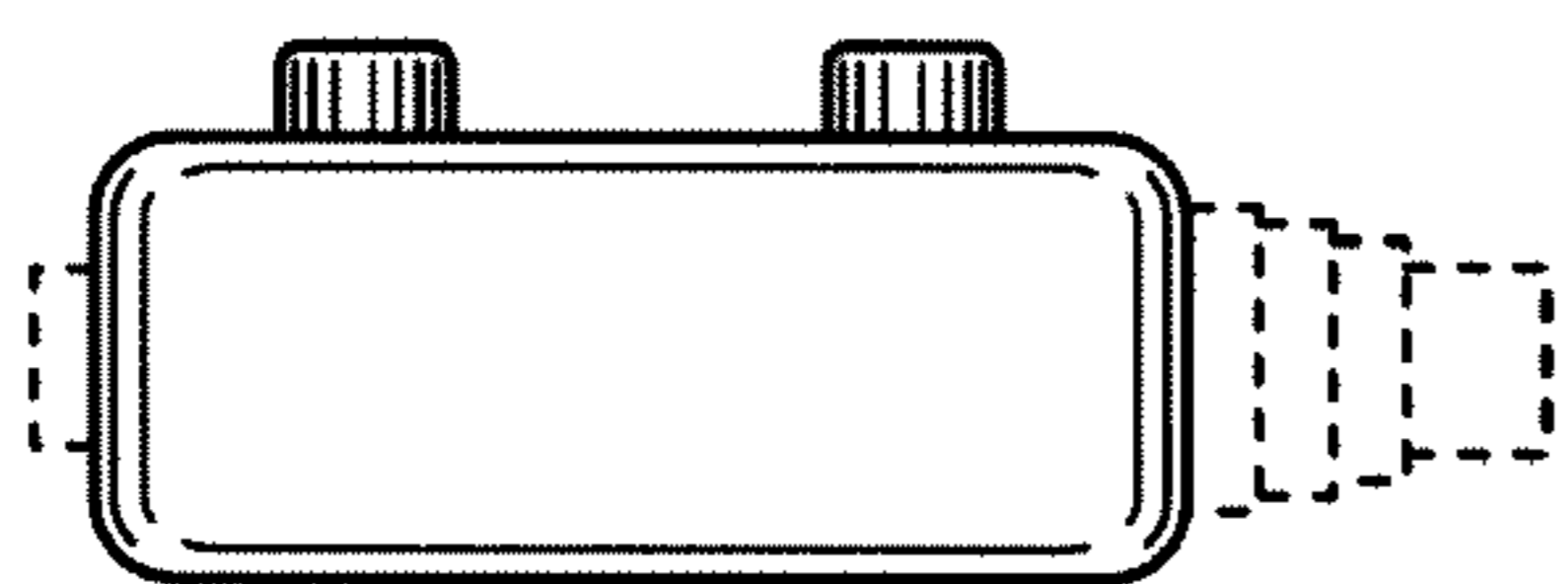

FIG. 31

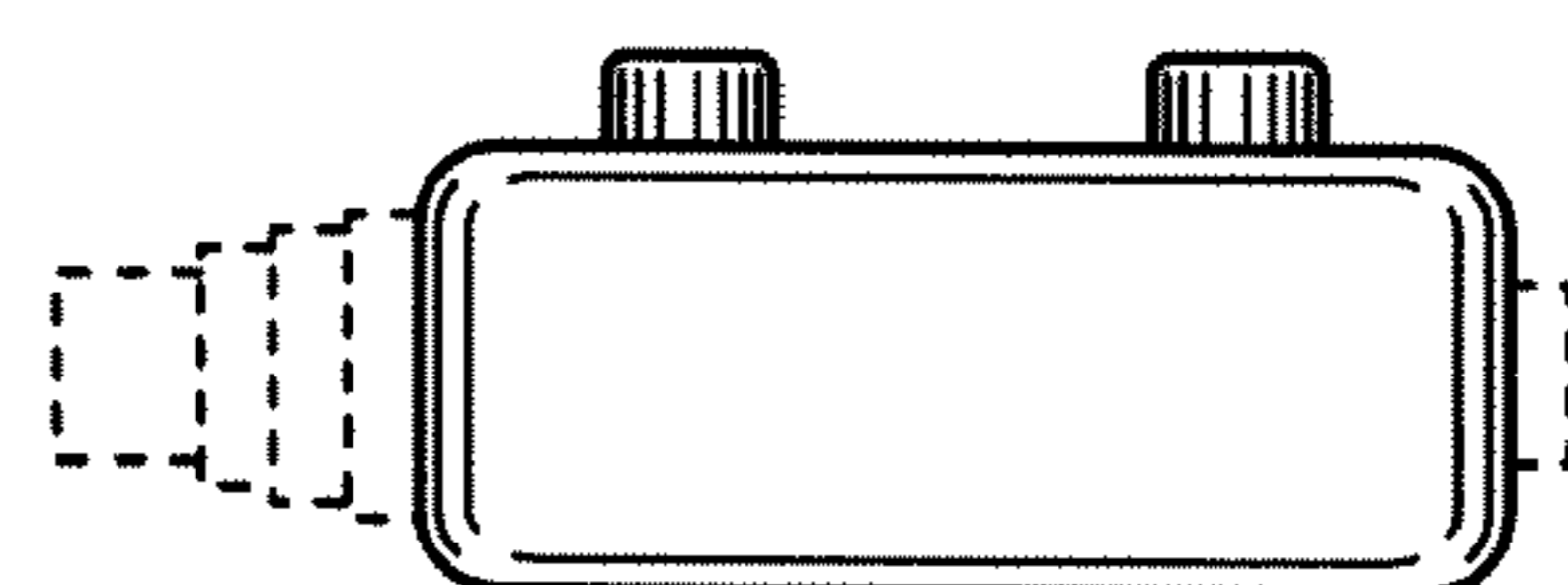

FIG. 32

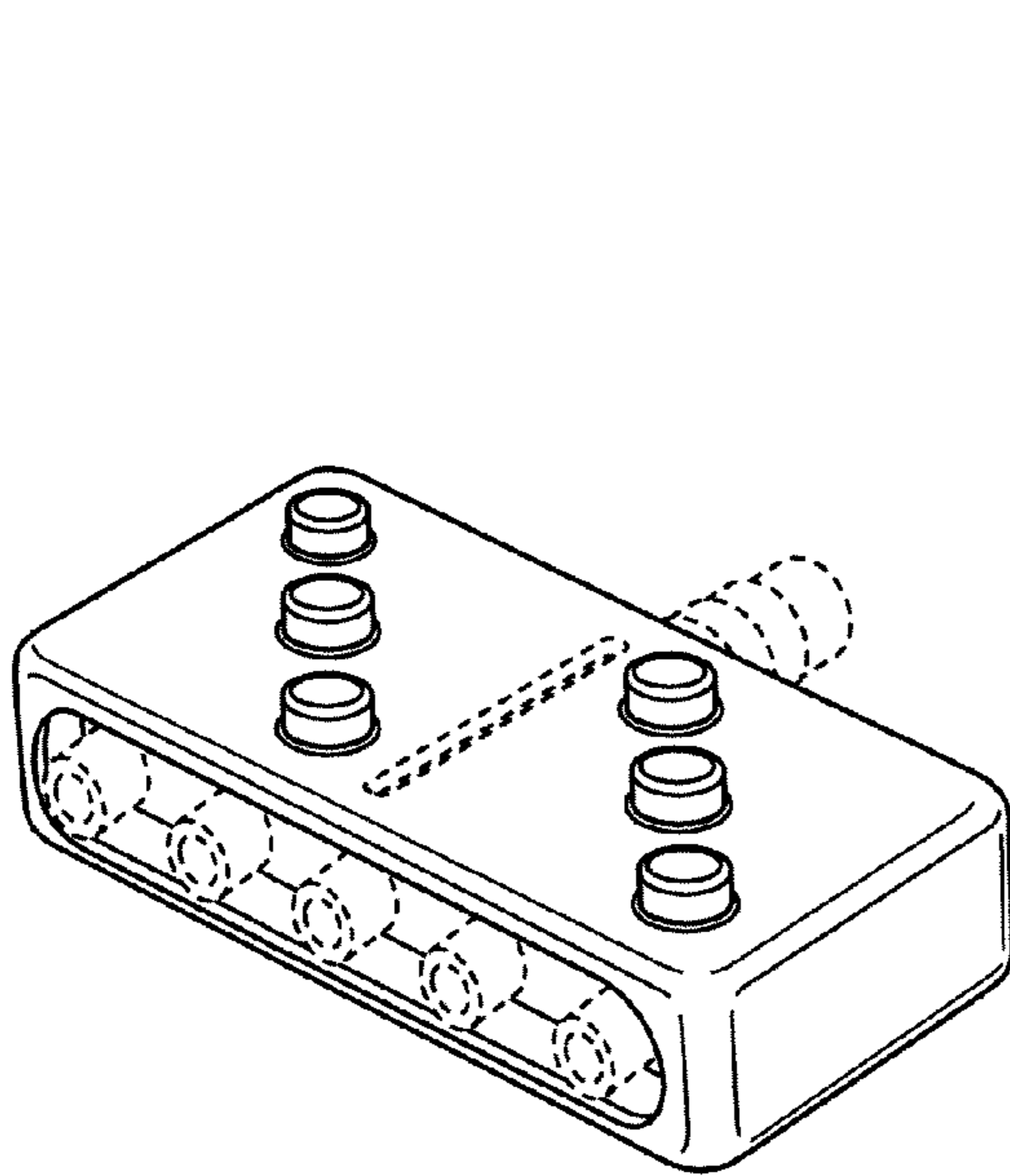

FIG. 33

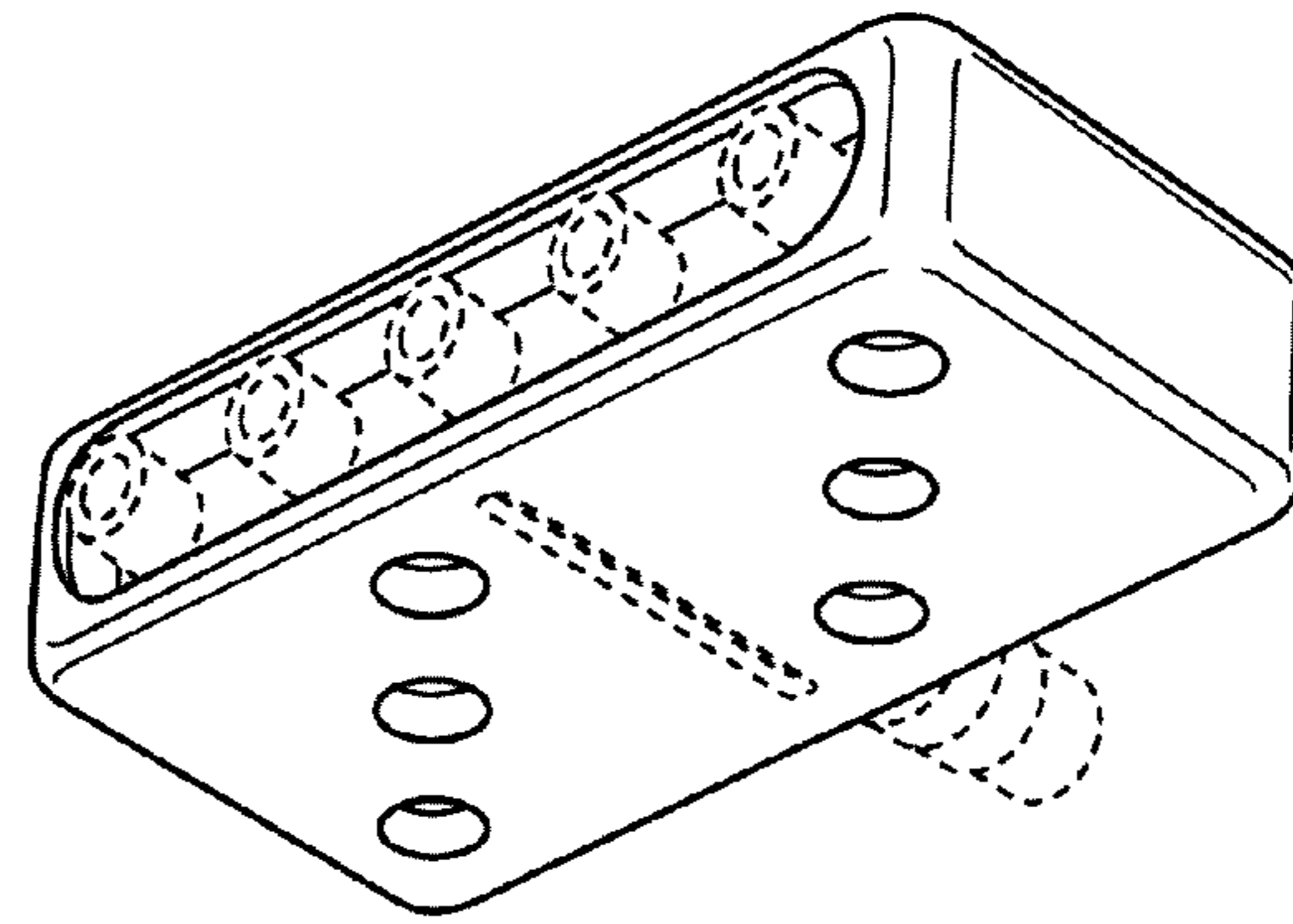

FIG. 34

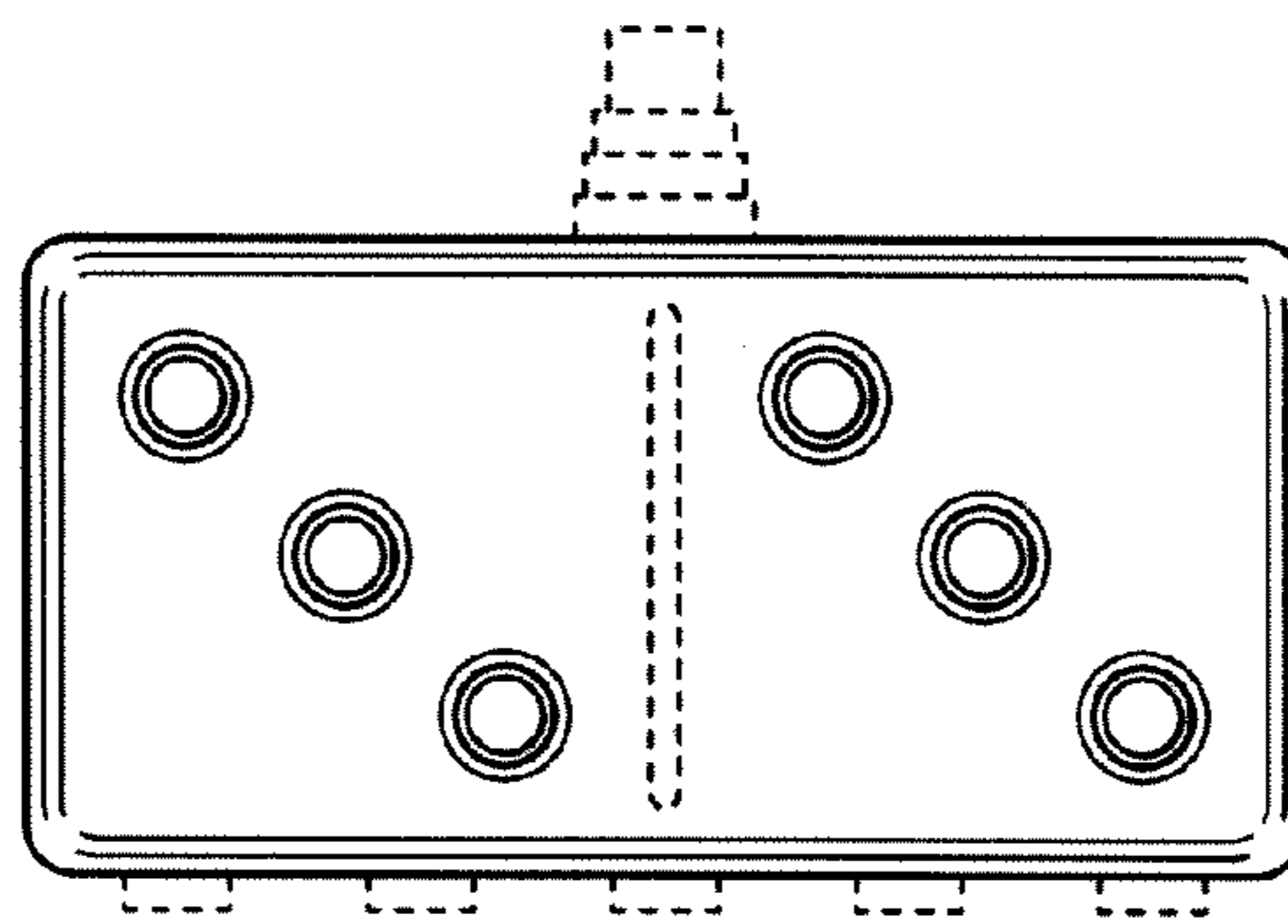

FIG. 35

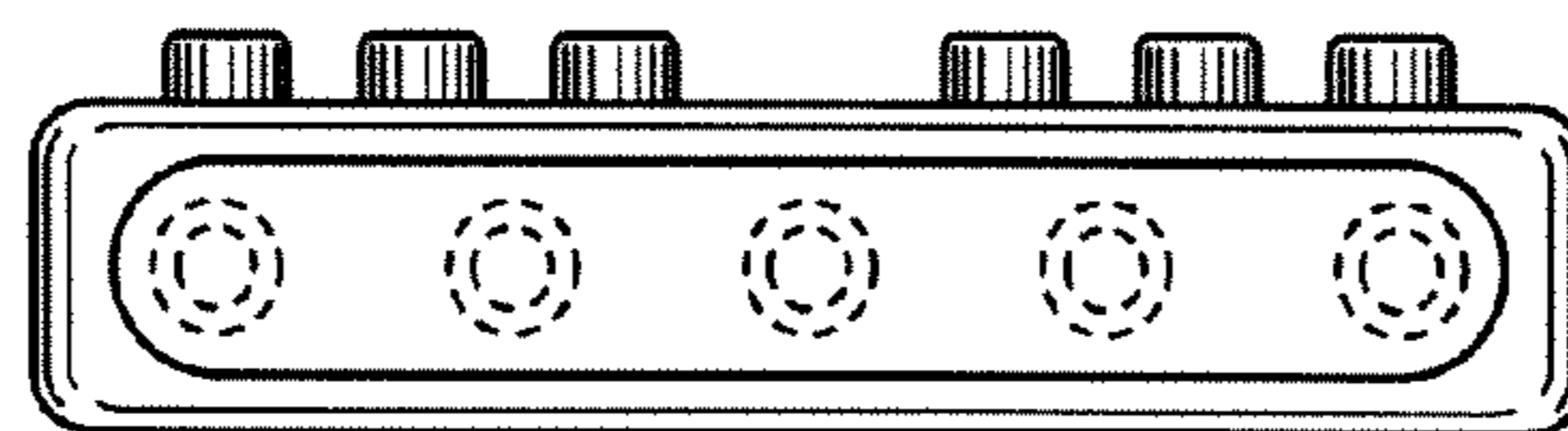

FIG. 36

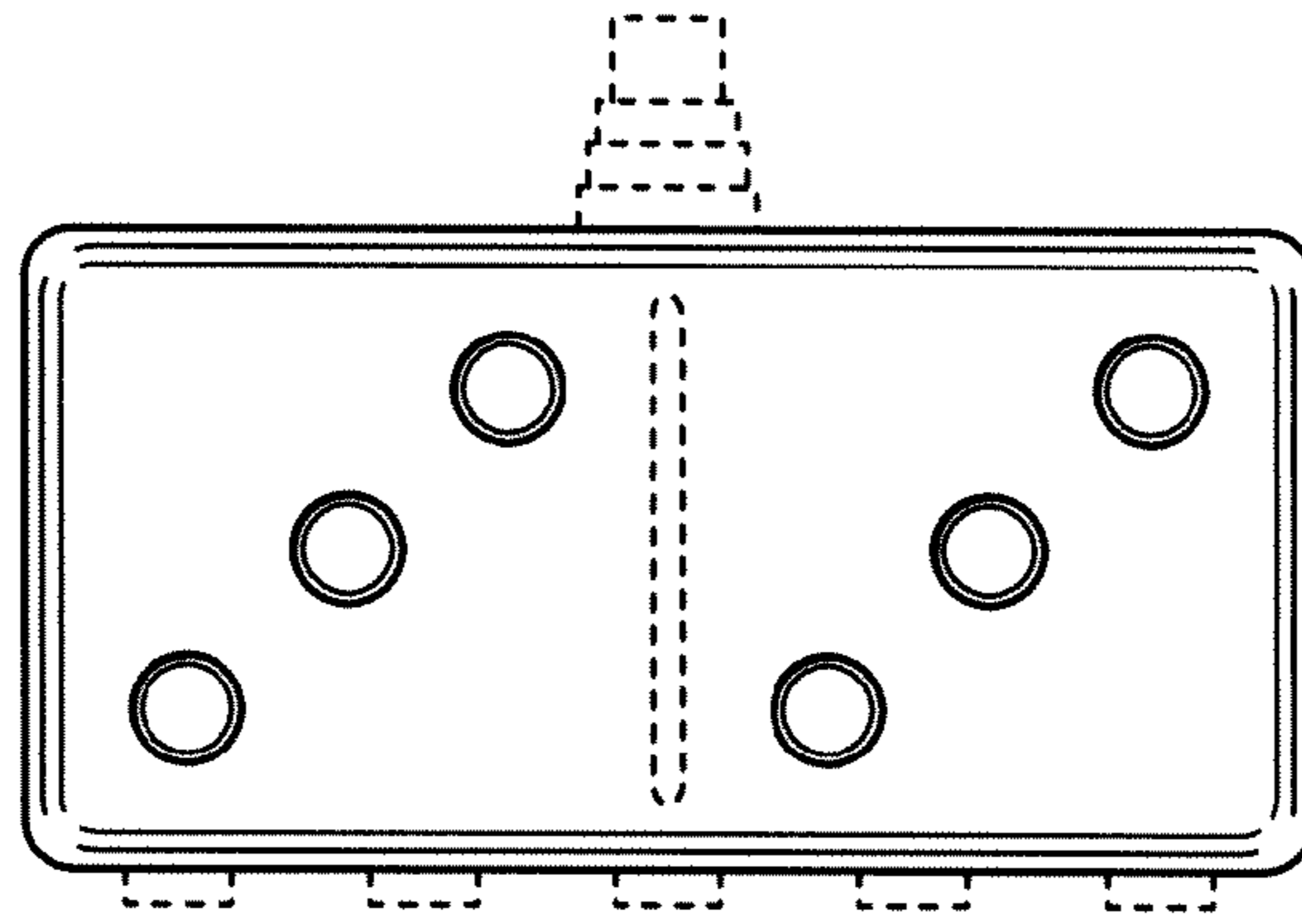

FIG. 37

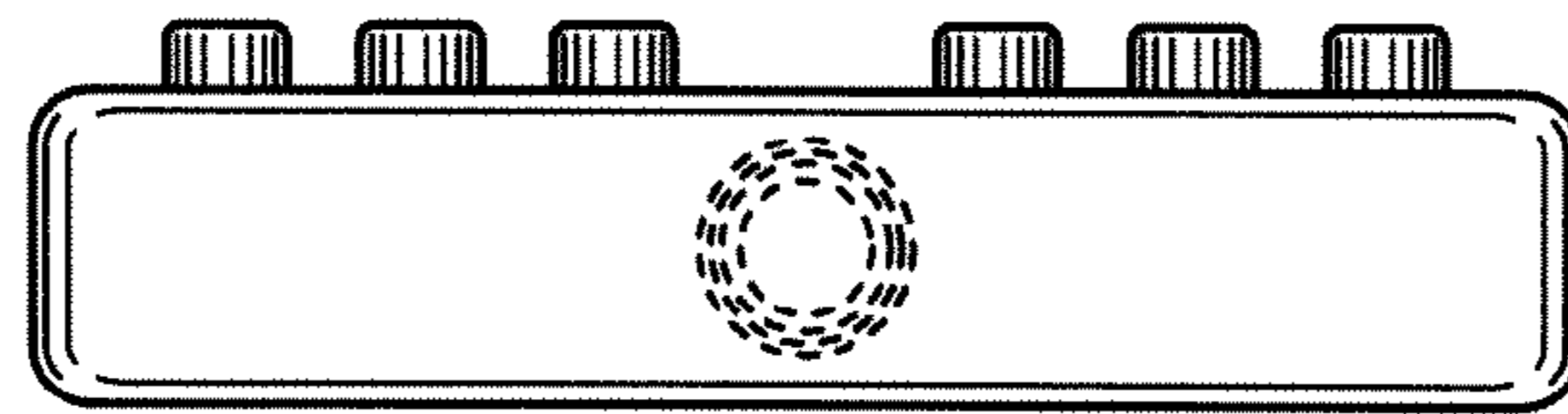

FIG. 38

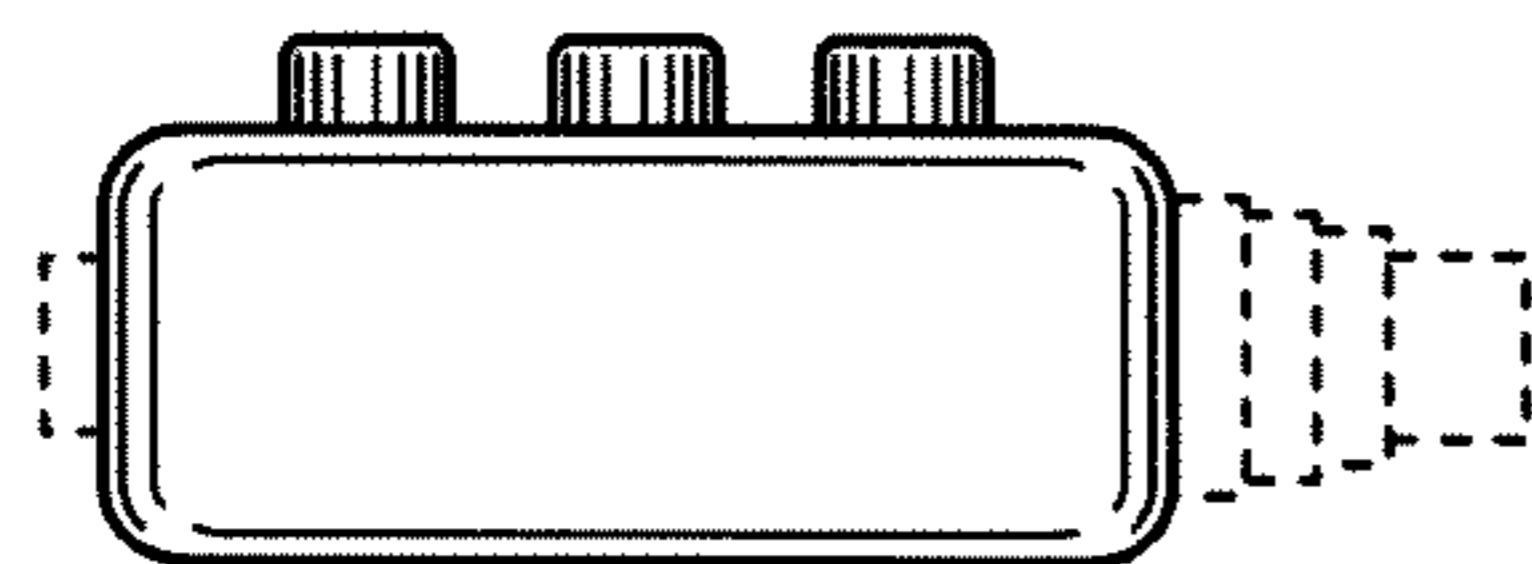

FIG. 39

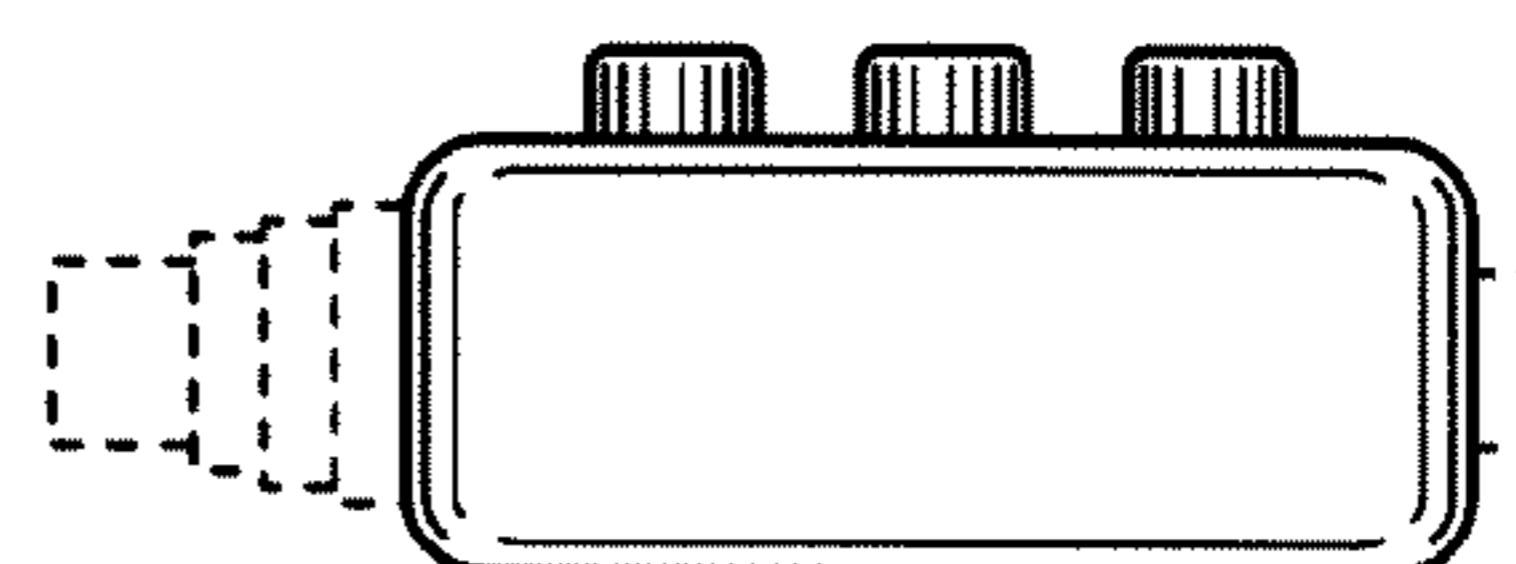

FIG. 40

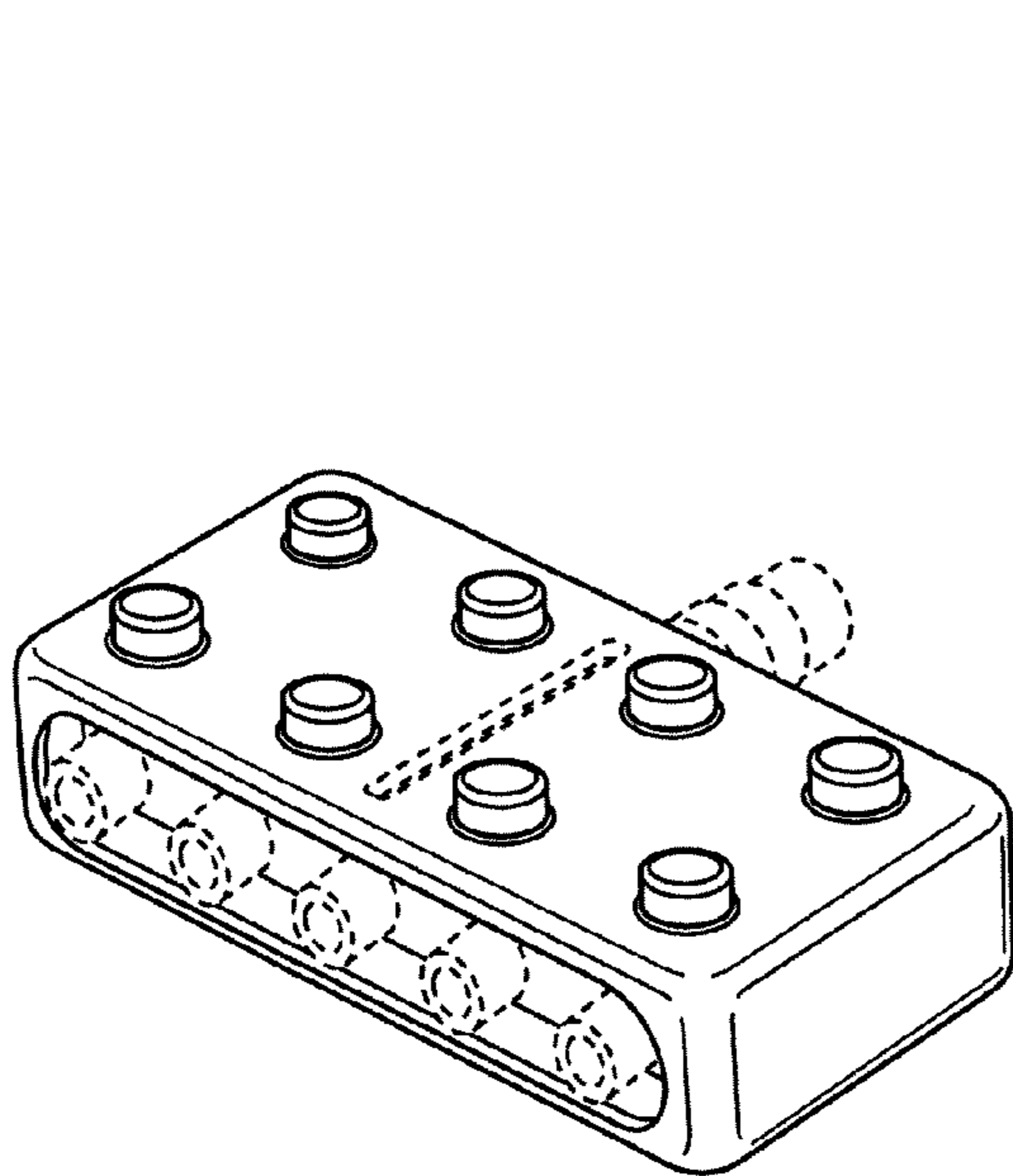

FIG. 41

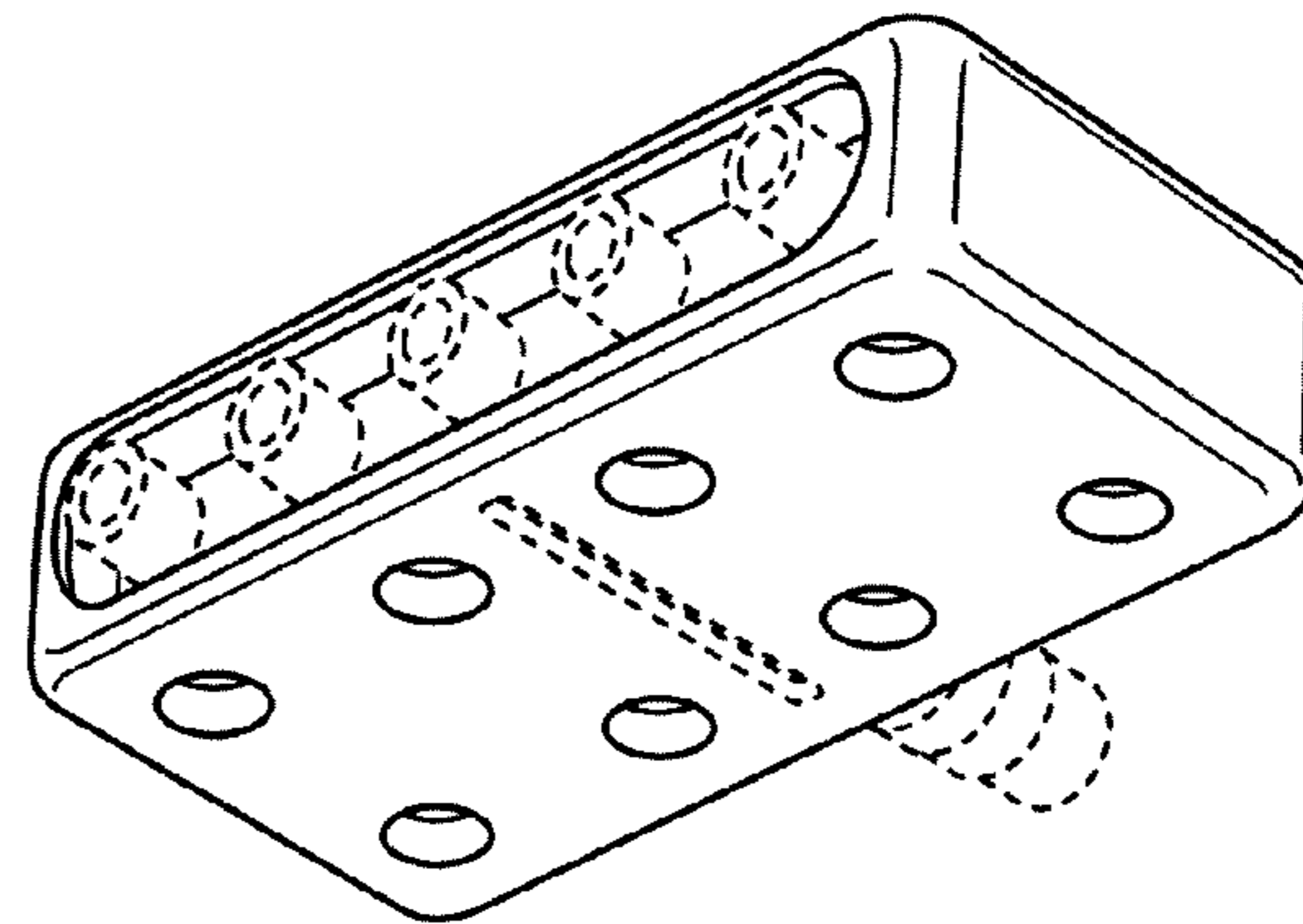

FIG. 42

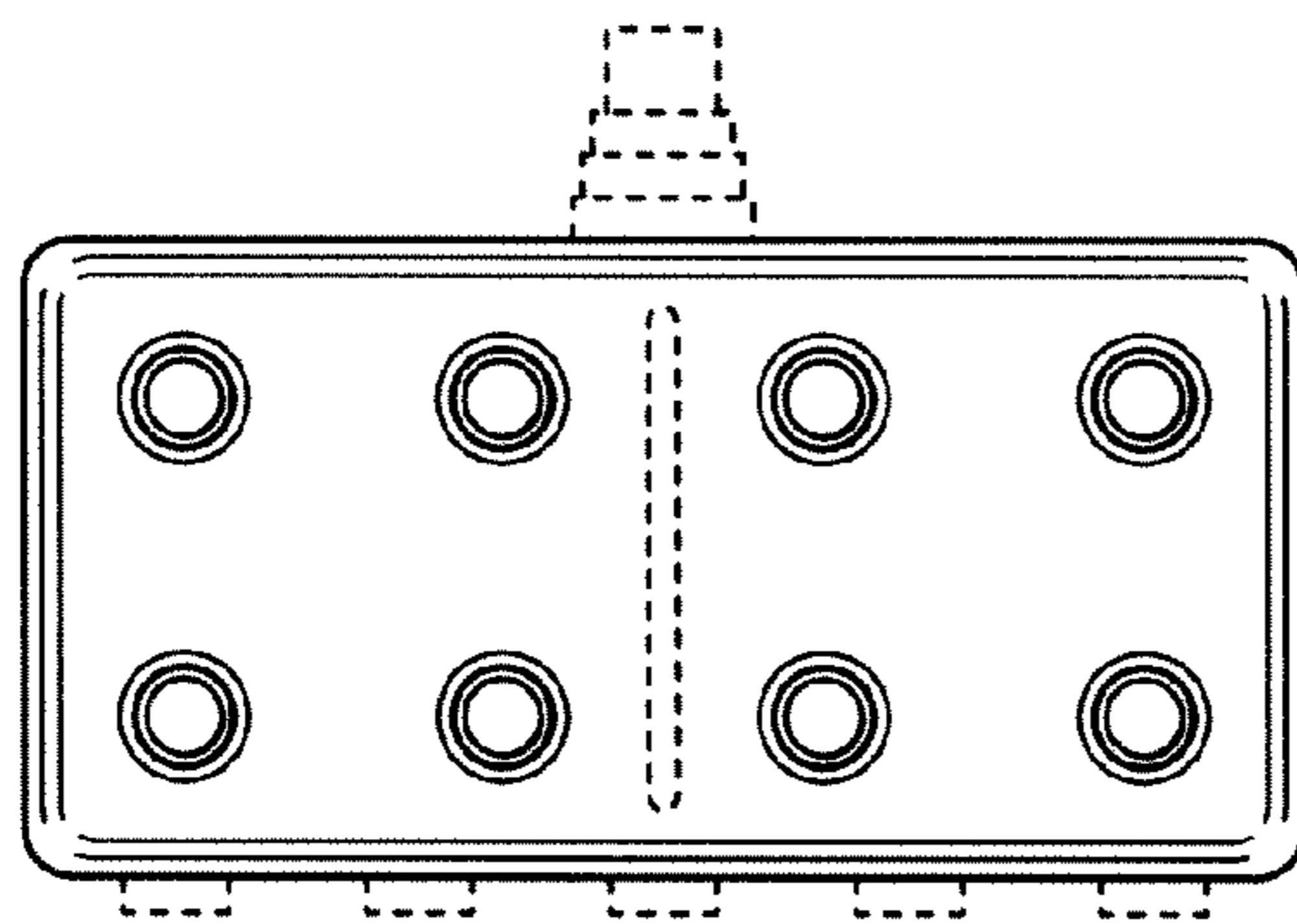

FIG. 43

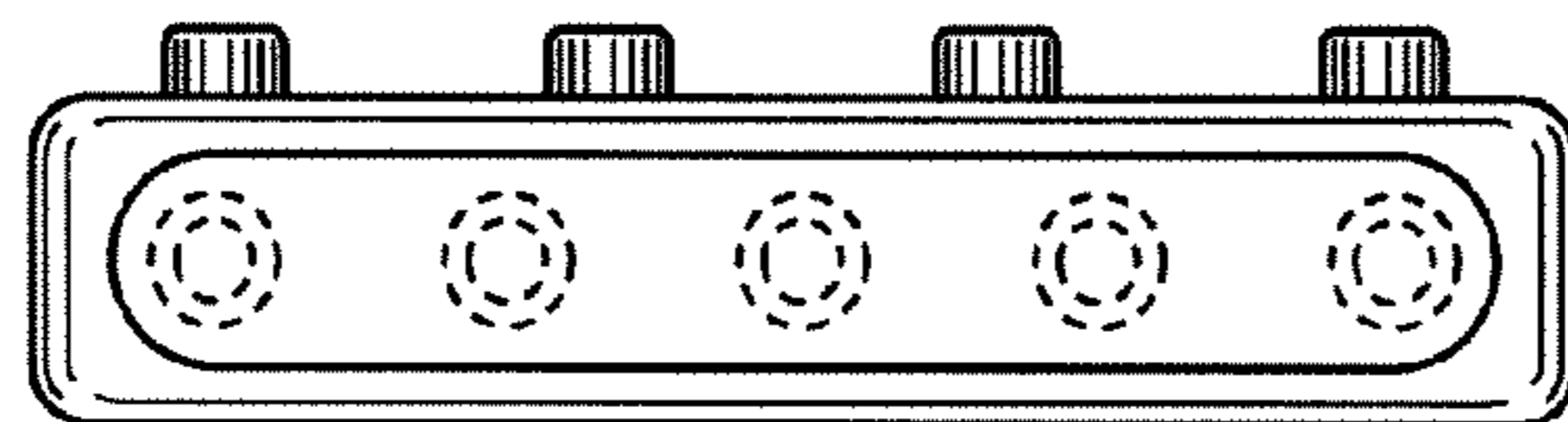

FIG. 44

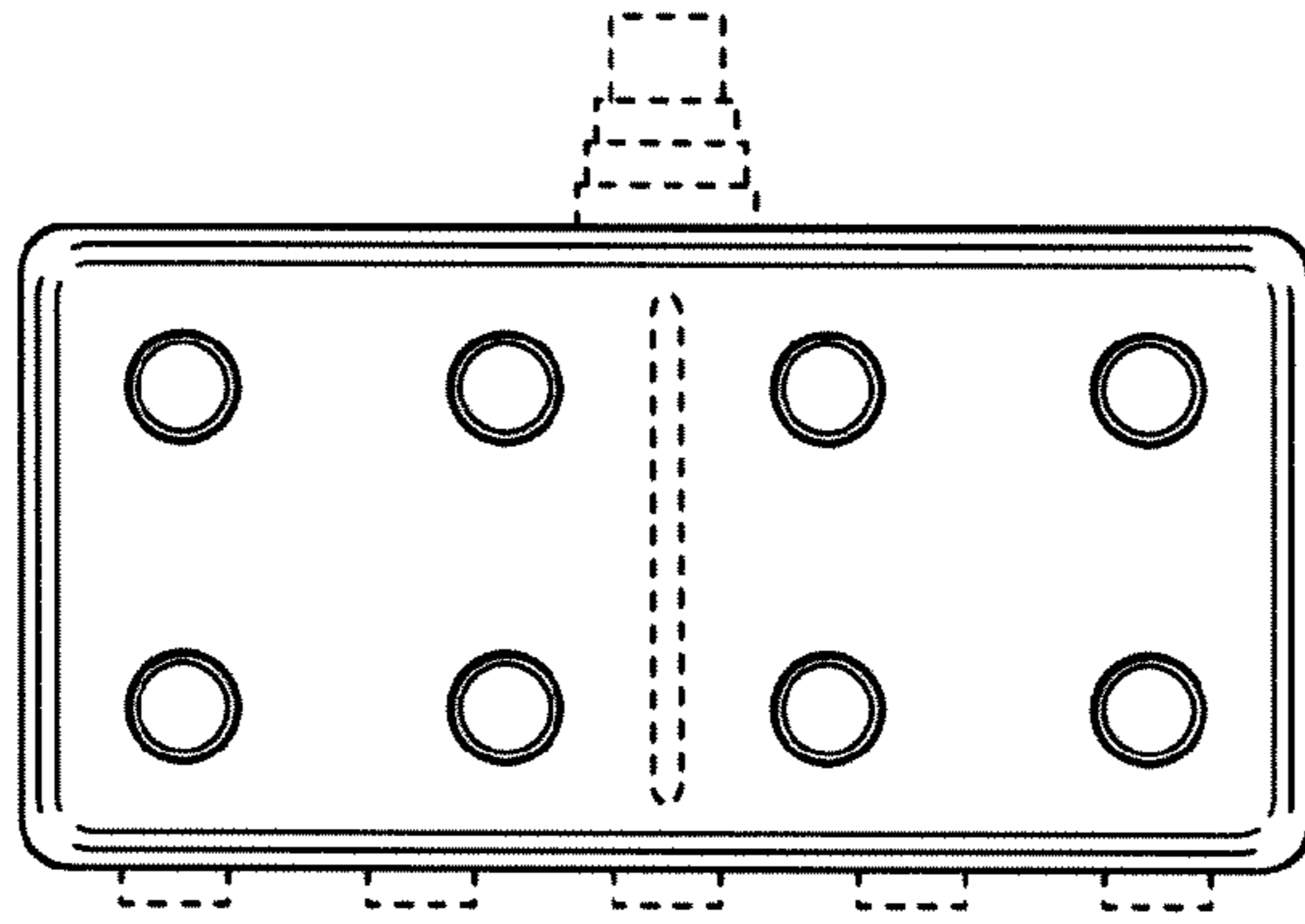

FIG. 45

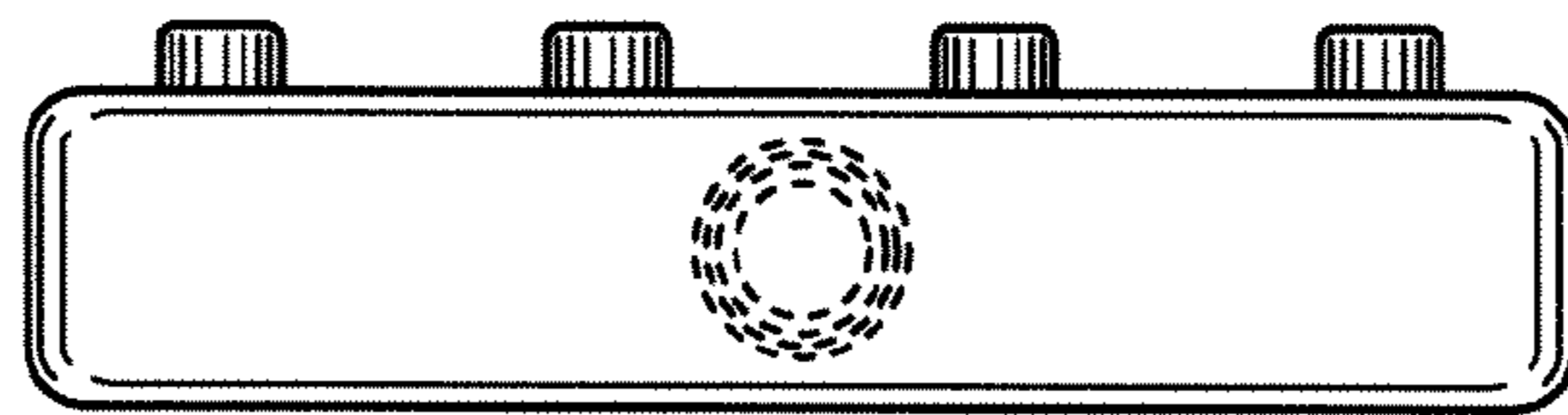

FIG. 46

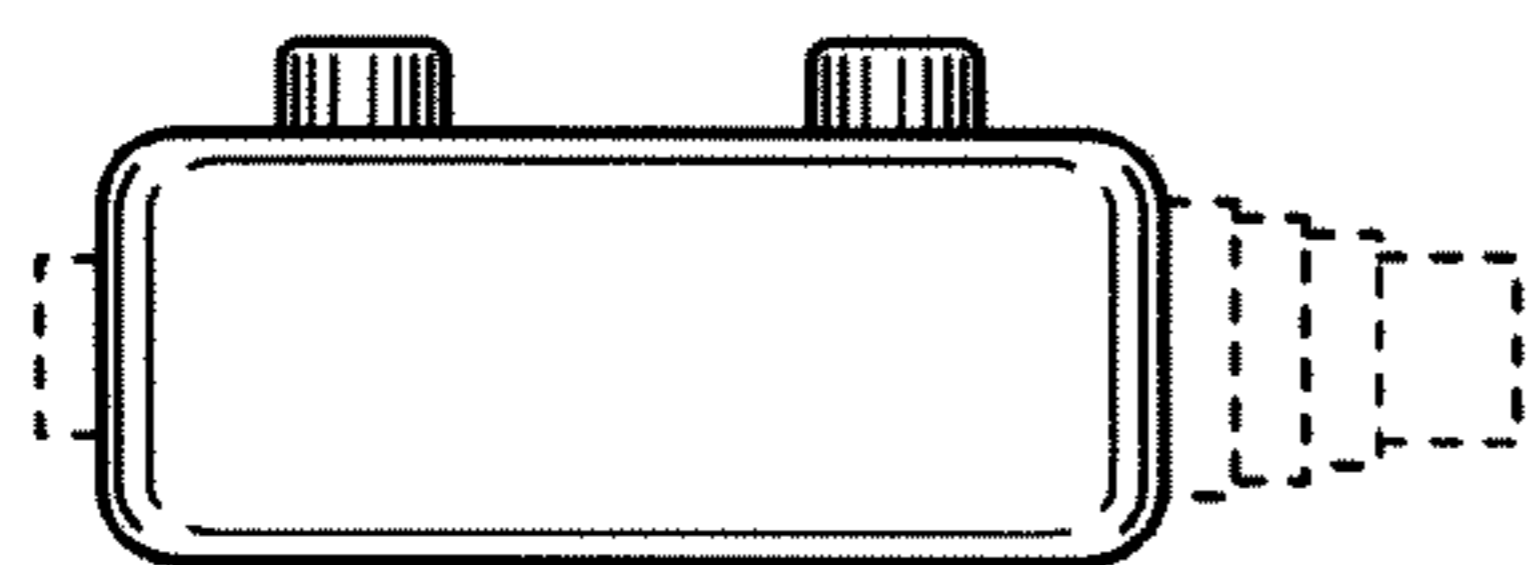

FIG. 47

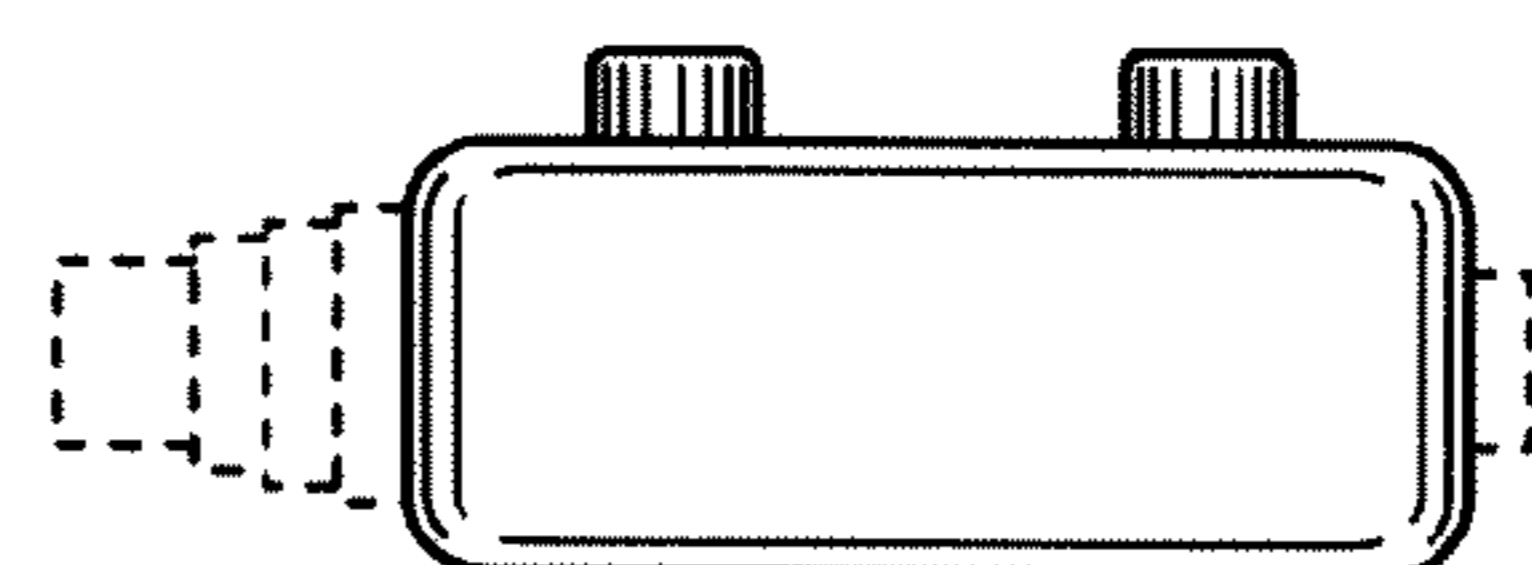

FIG. 48

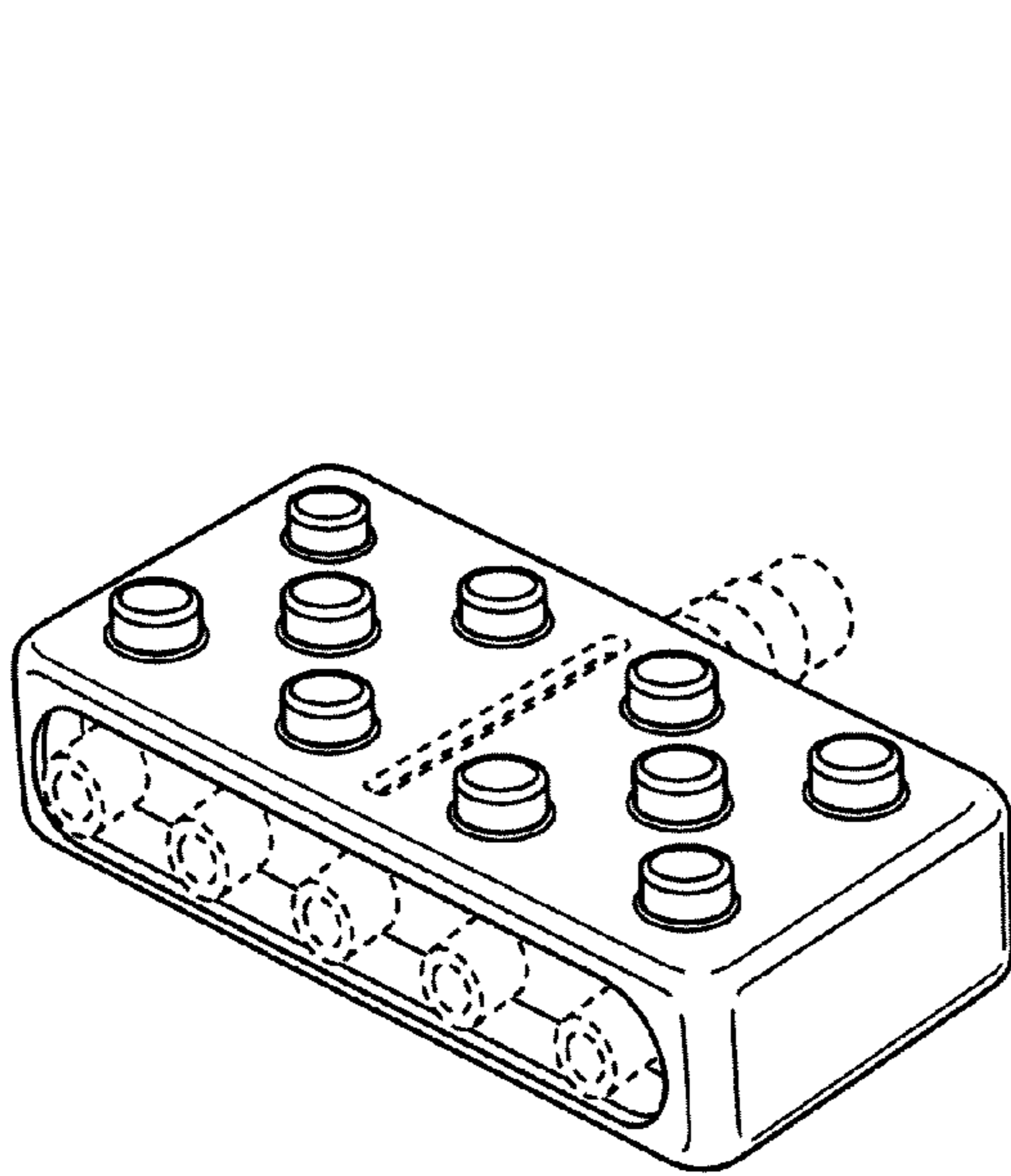

FIG. 49

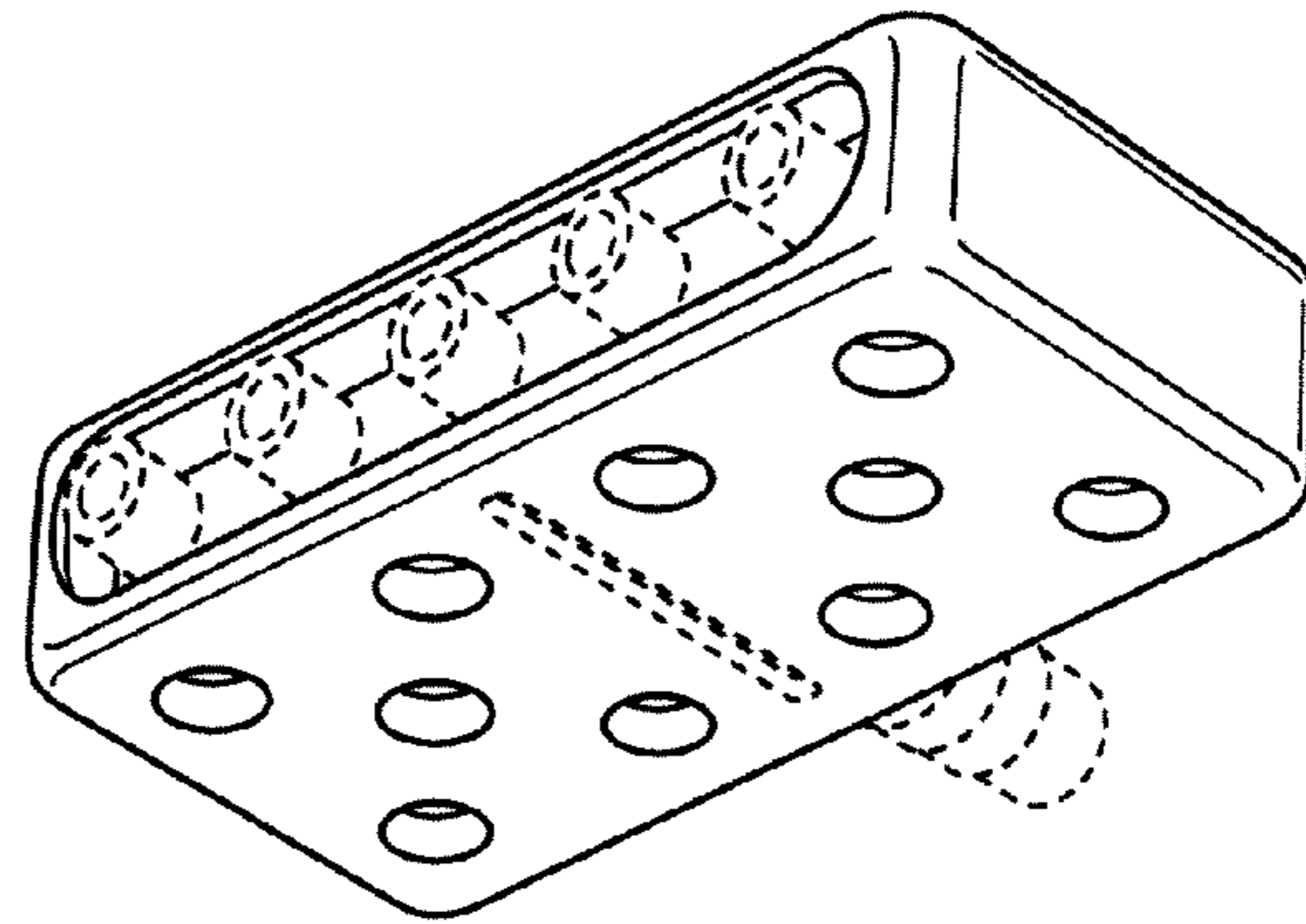

FIG. 50

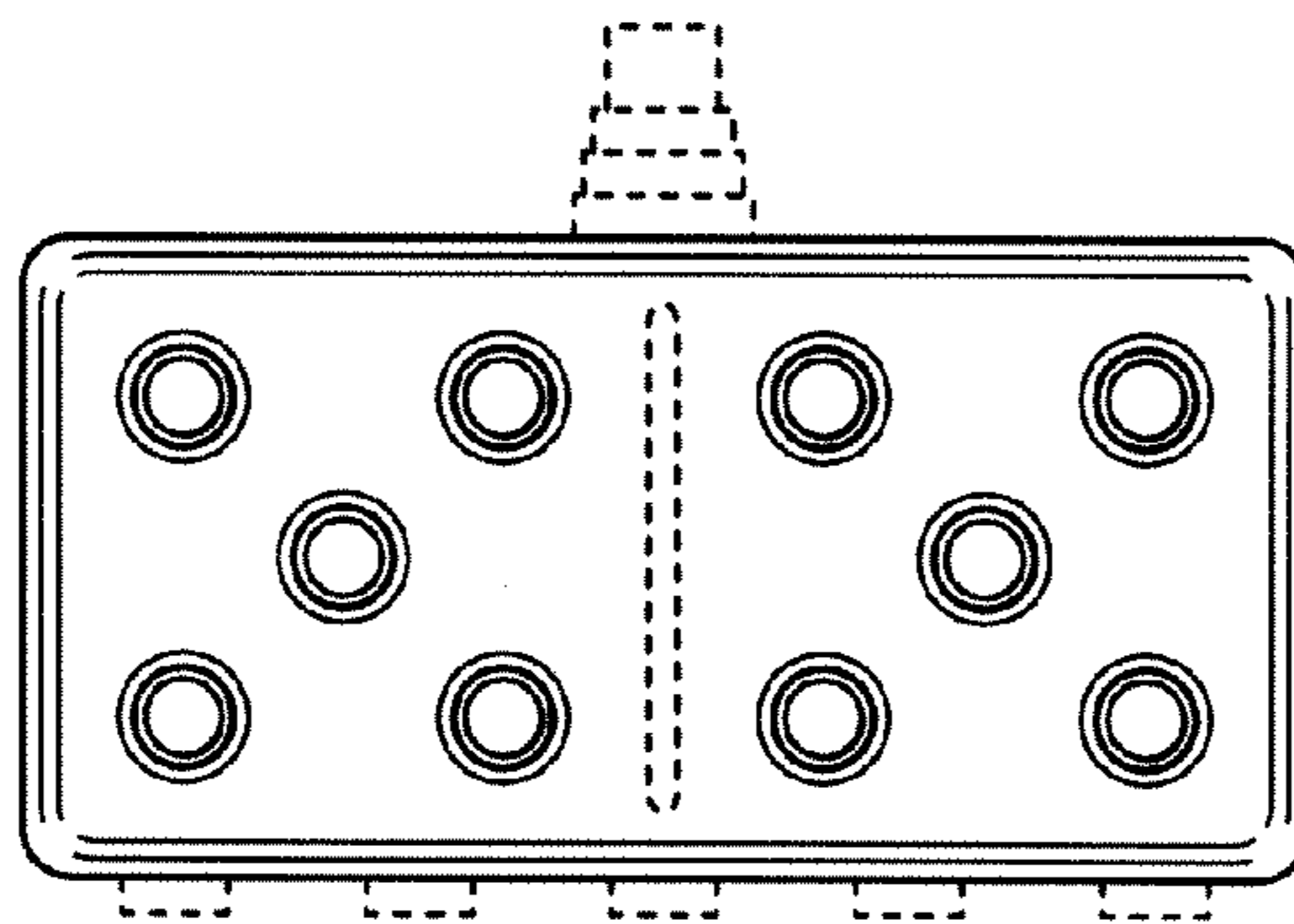

FIG. 51

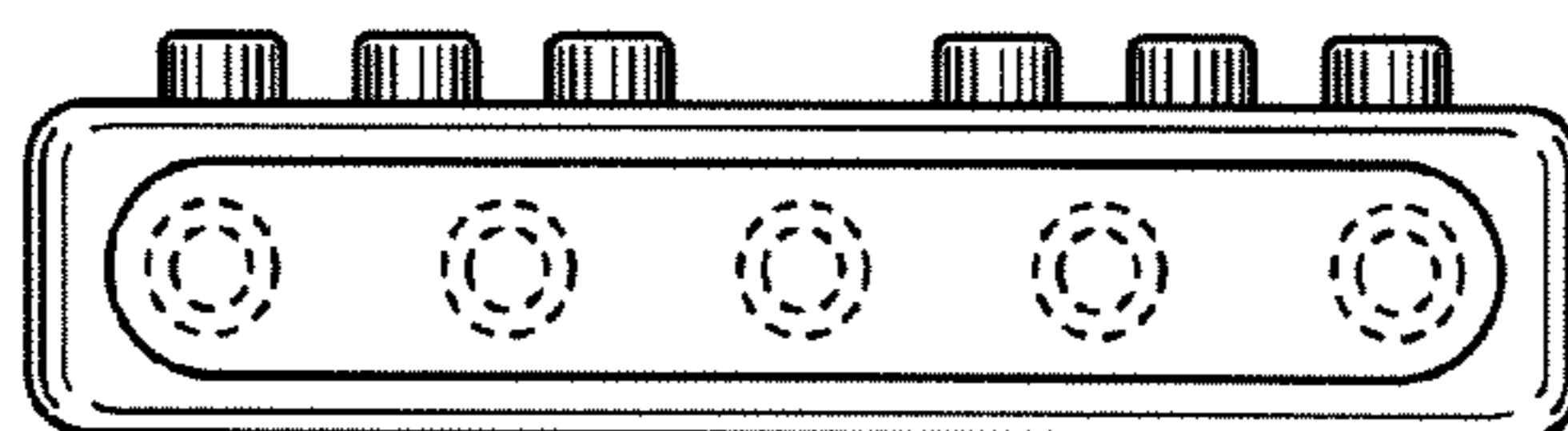

FIG. 52

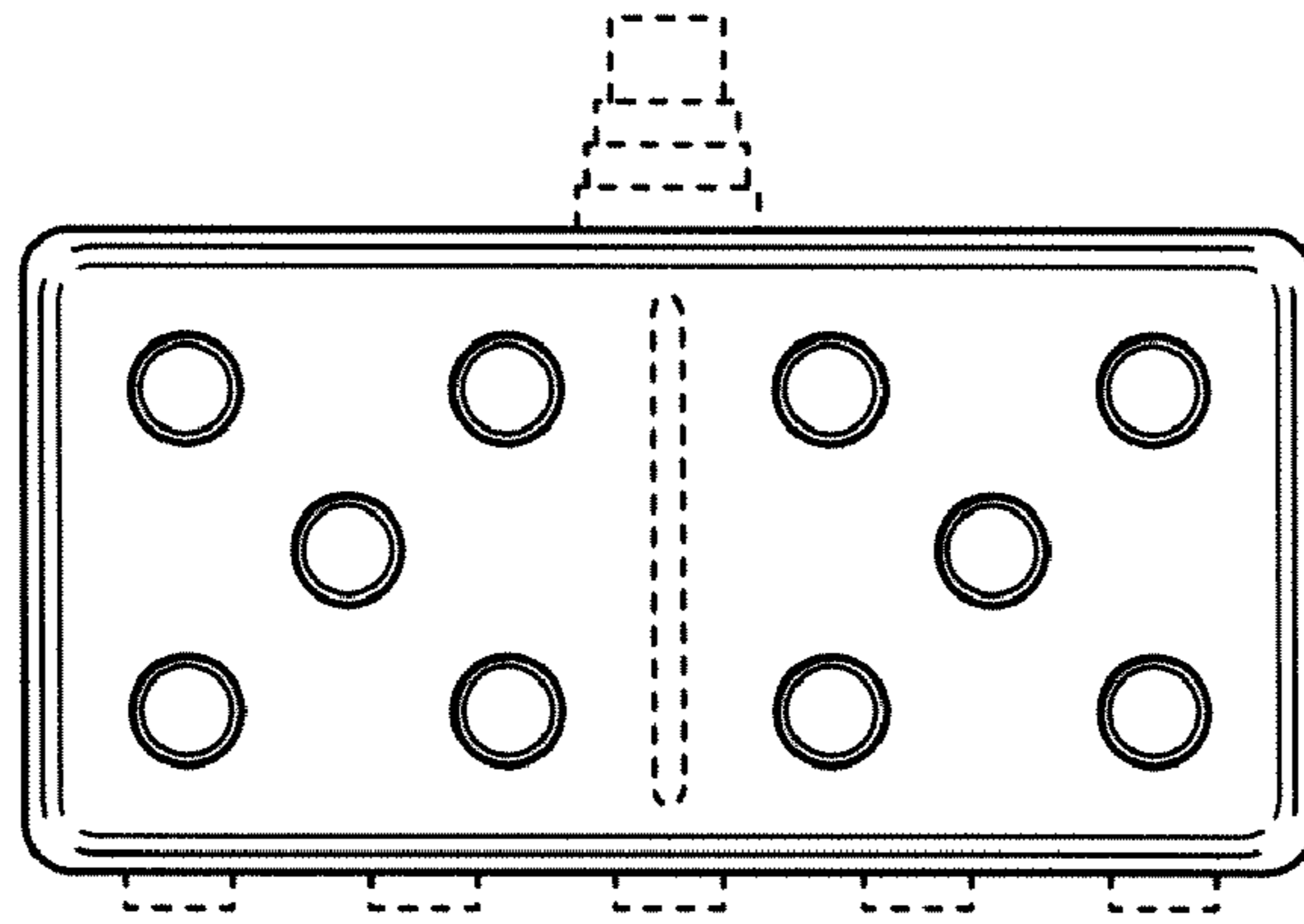

FIG. 53

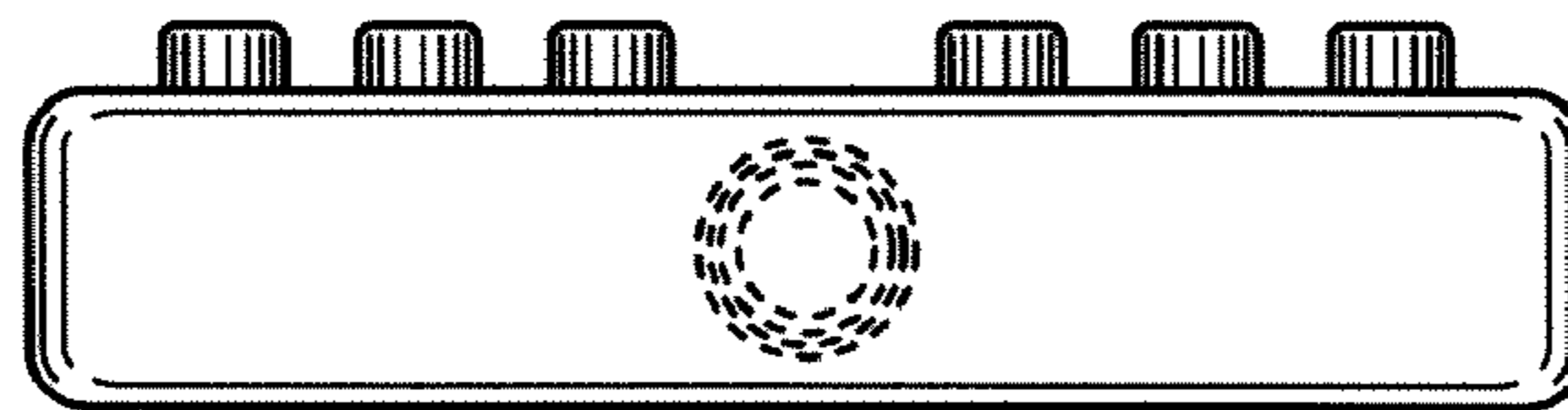

FIG. 54

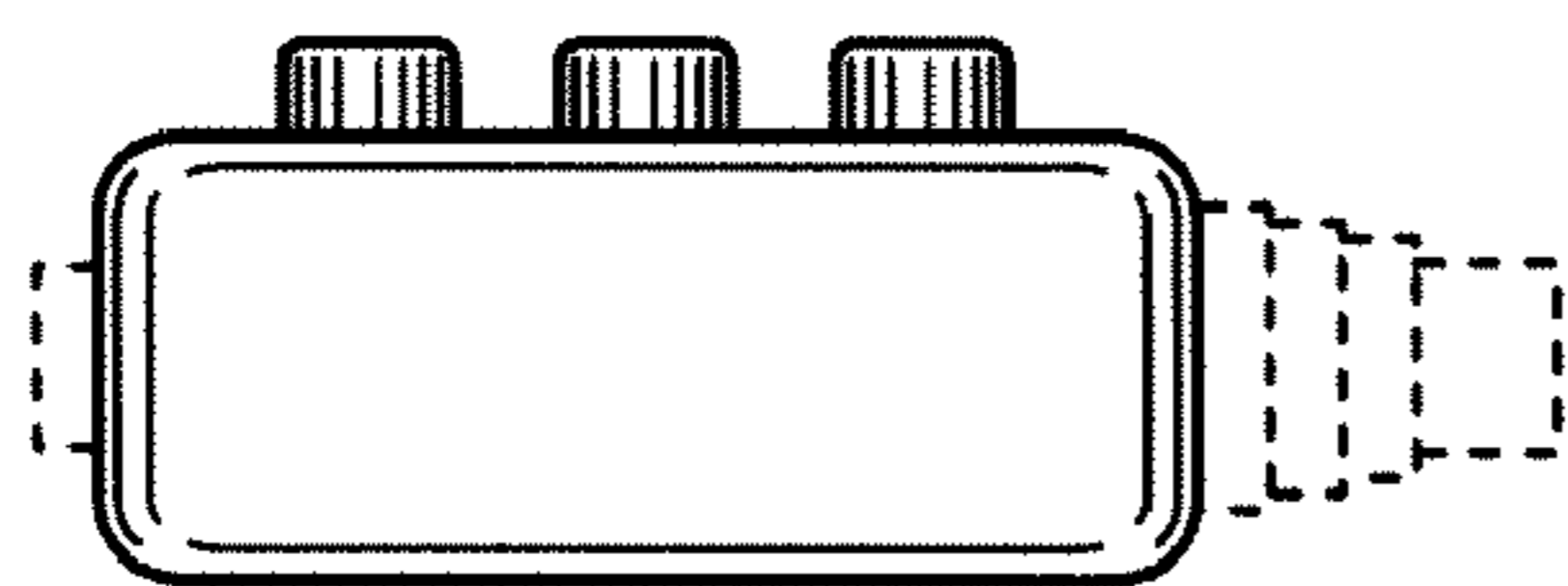

FIG. 55

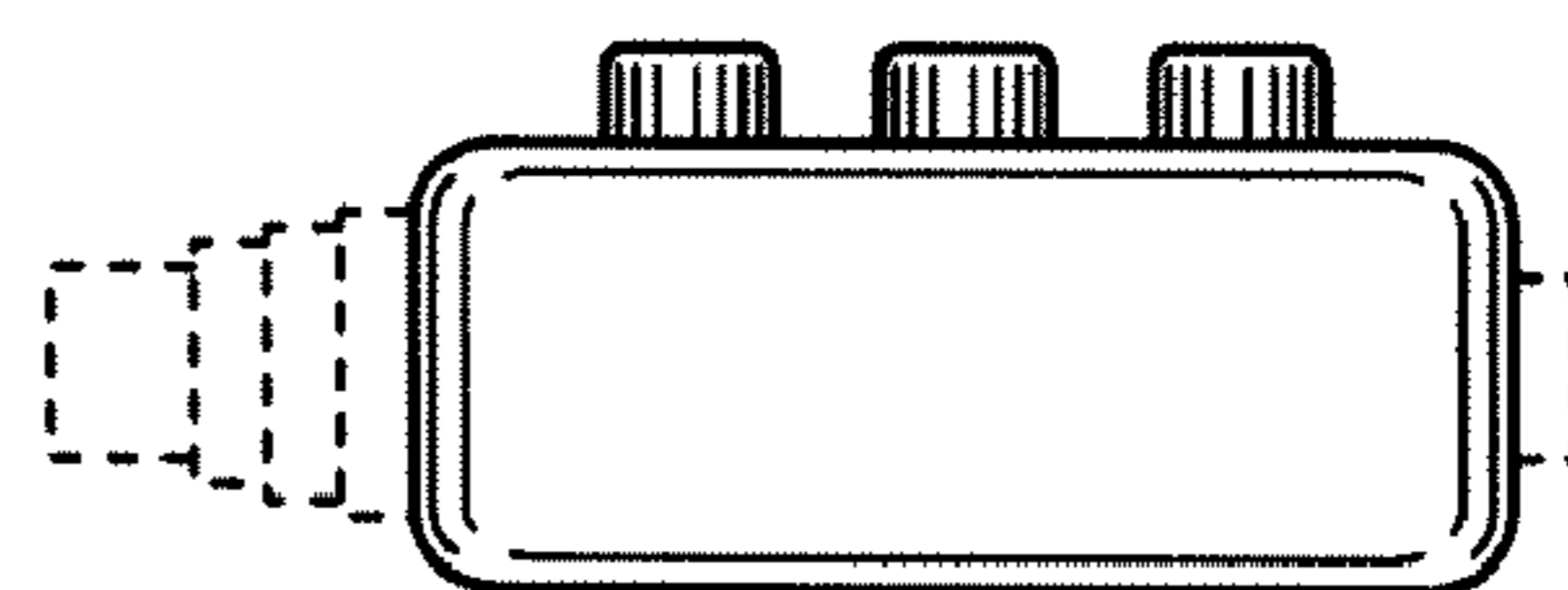

FIG. 56

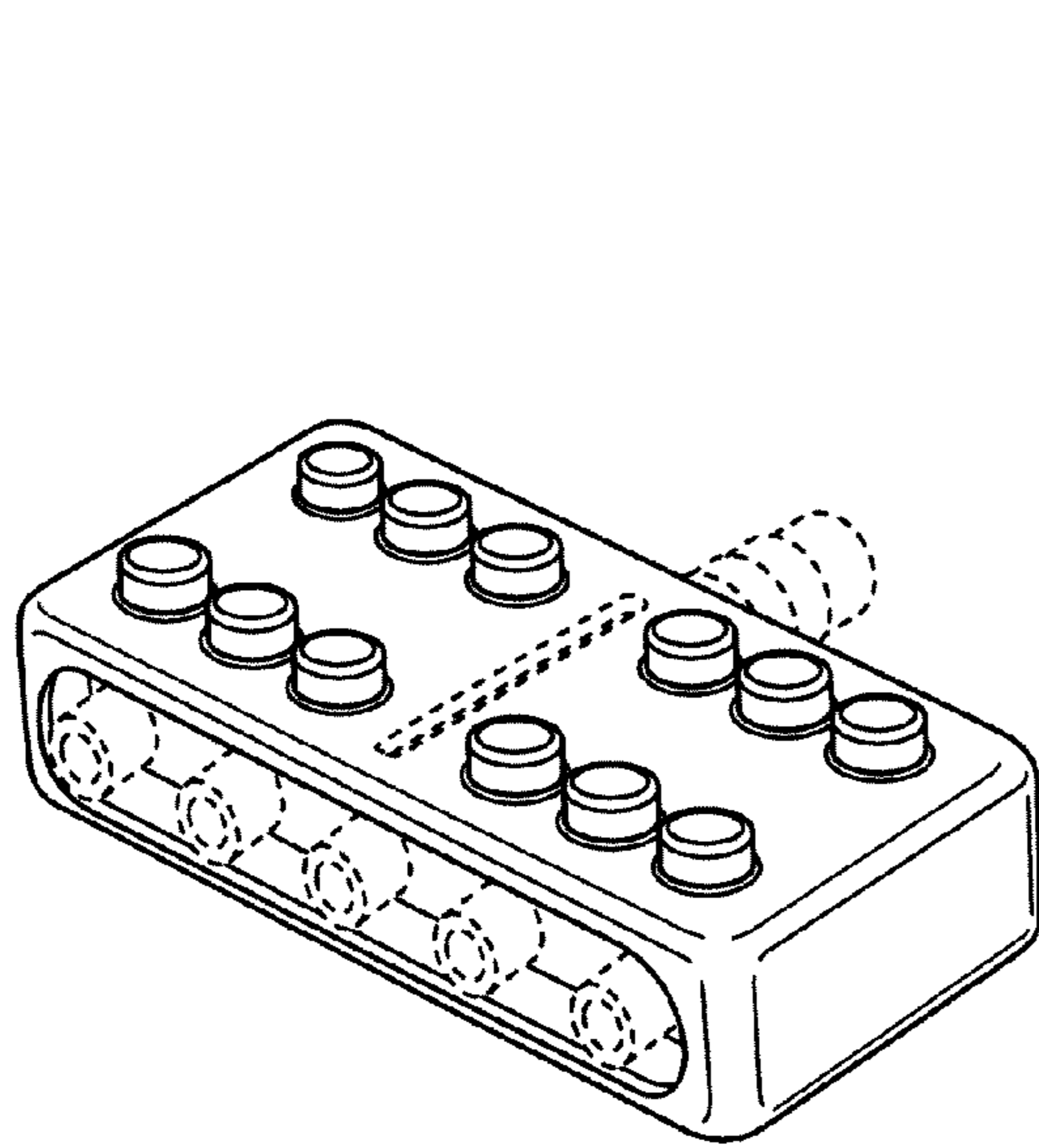

FIG. 57

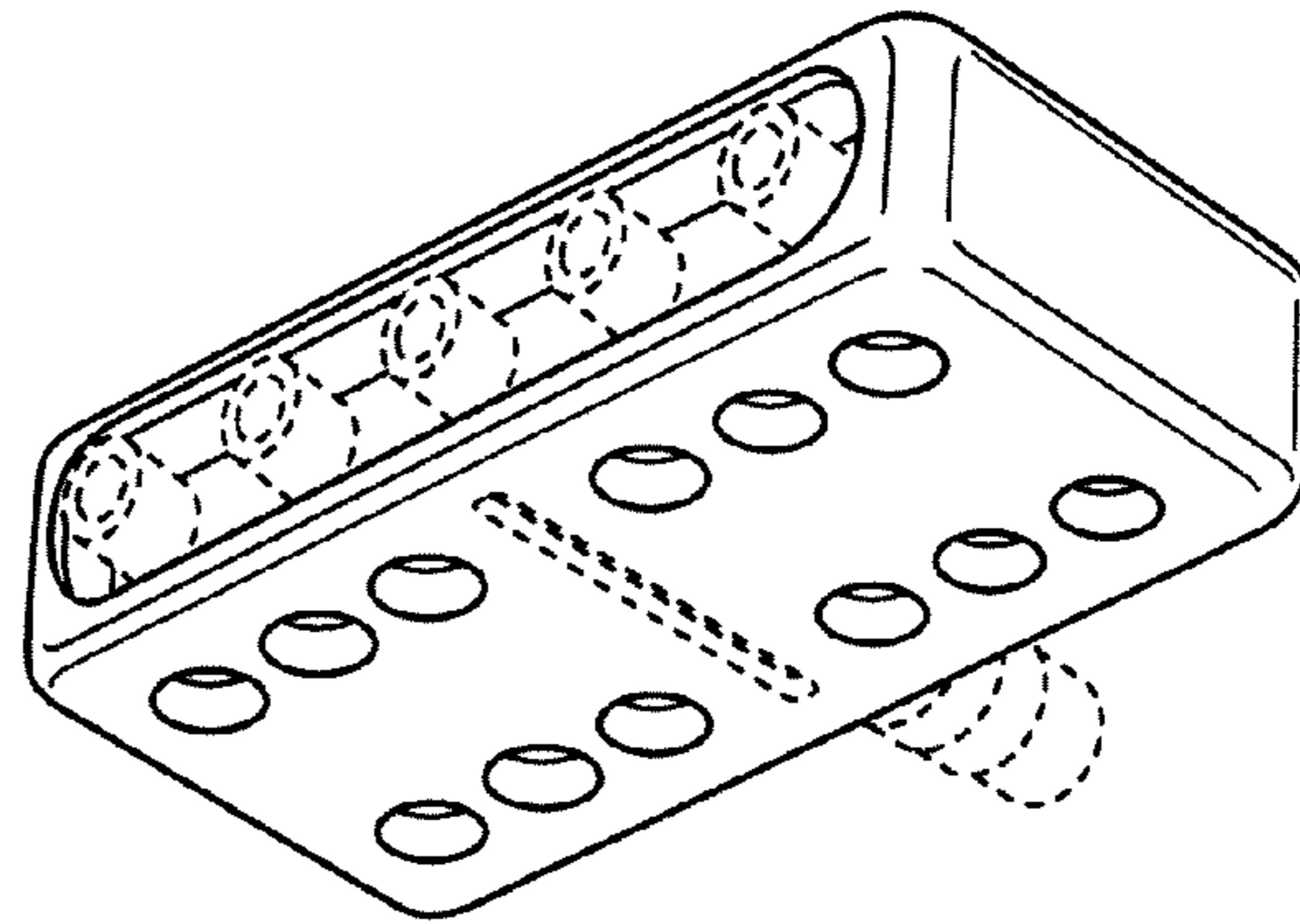

FIG. 58

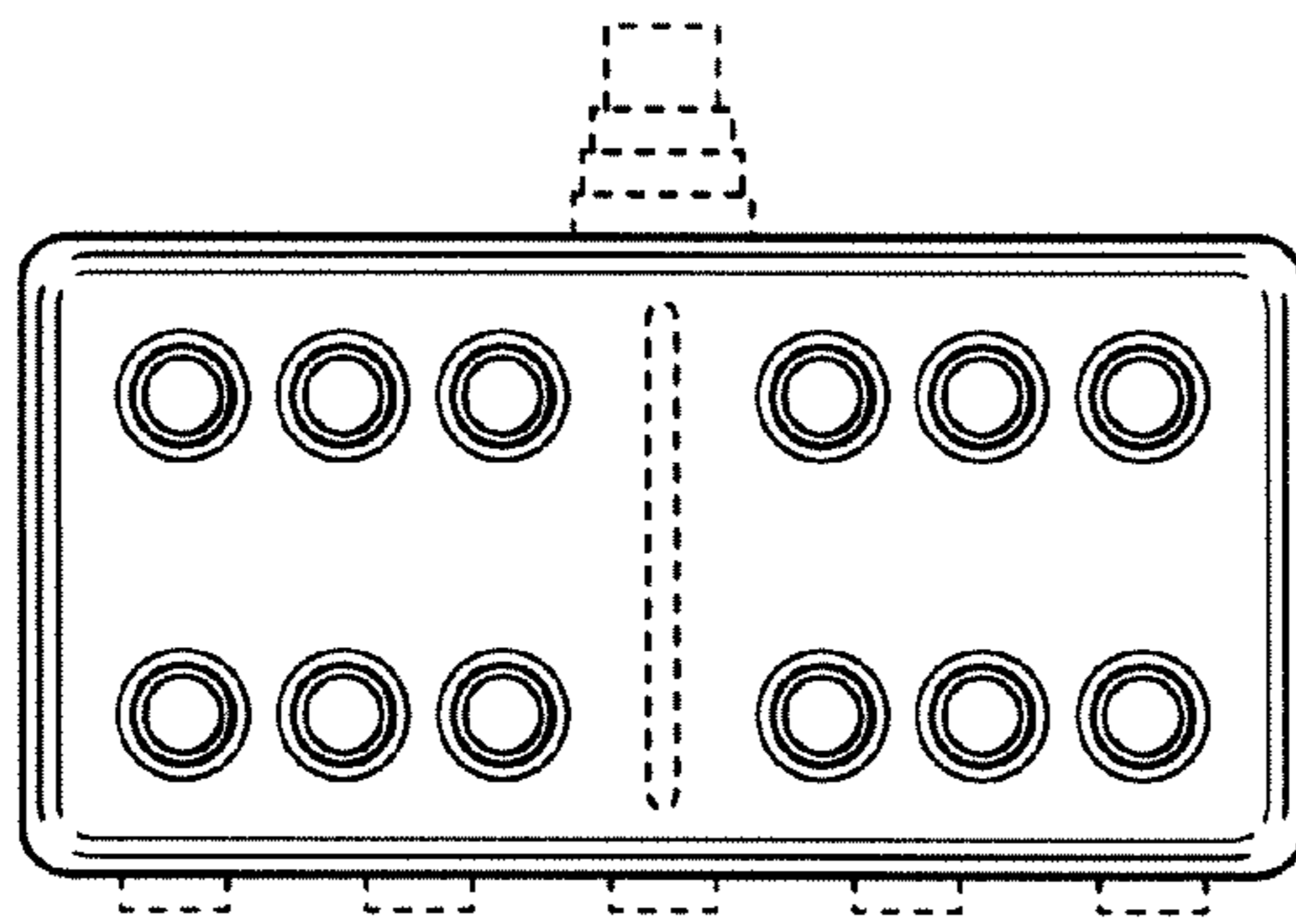

FIG. 59

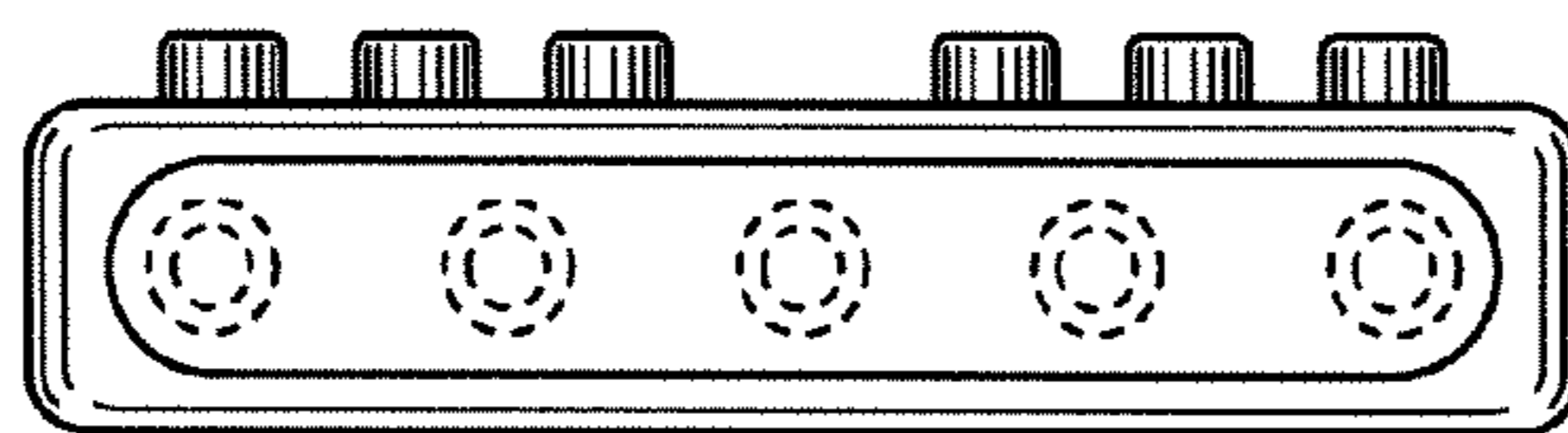

FIG. 60

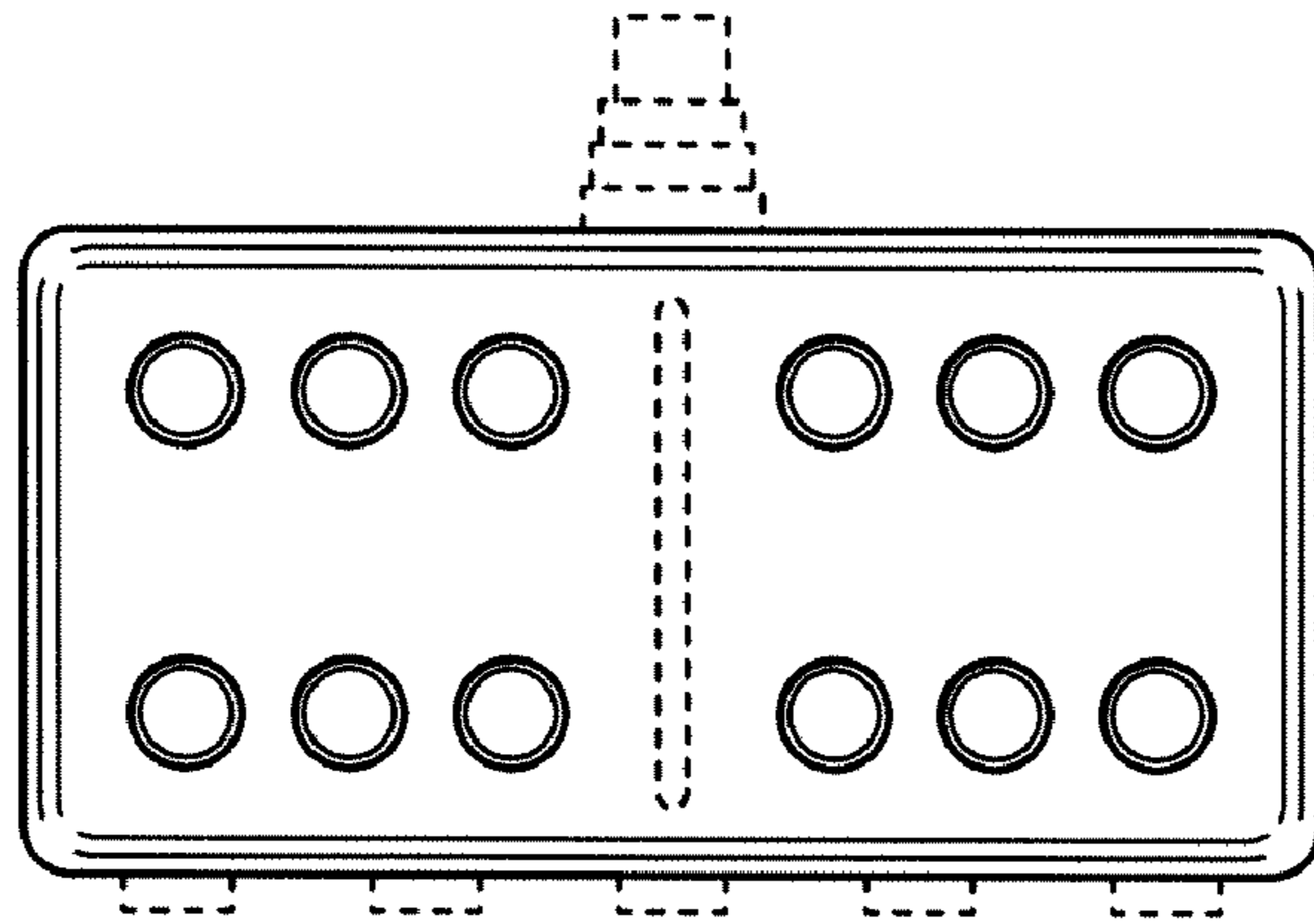

FIG. 61

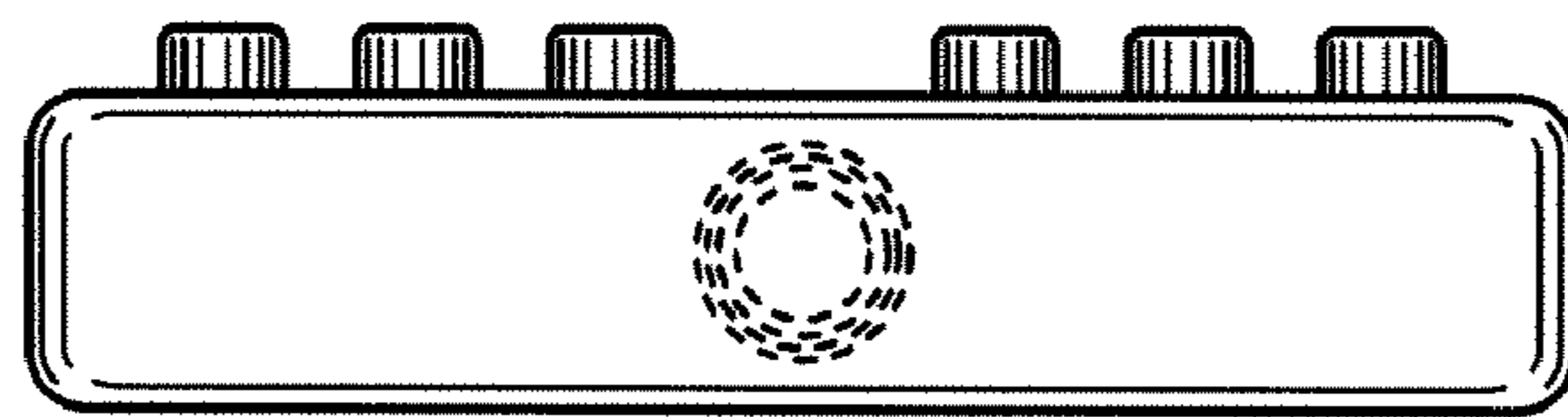

FIG. 62

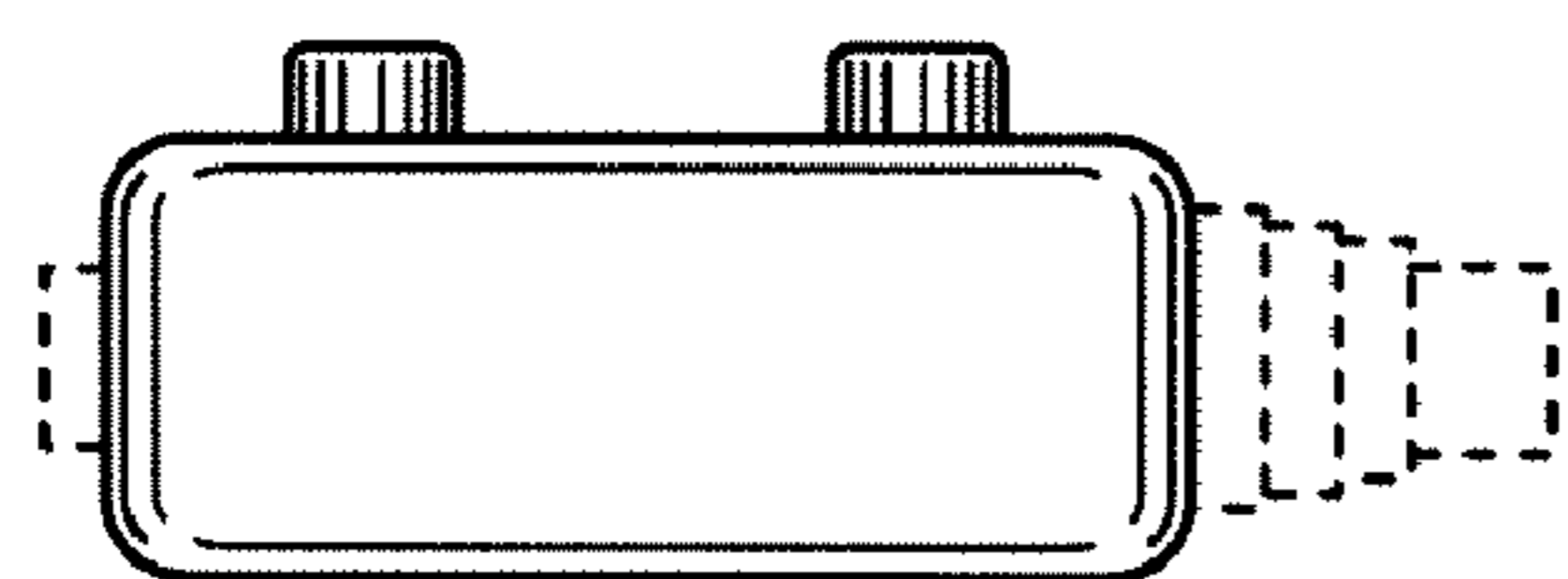

FIG. 63

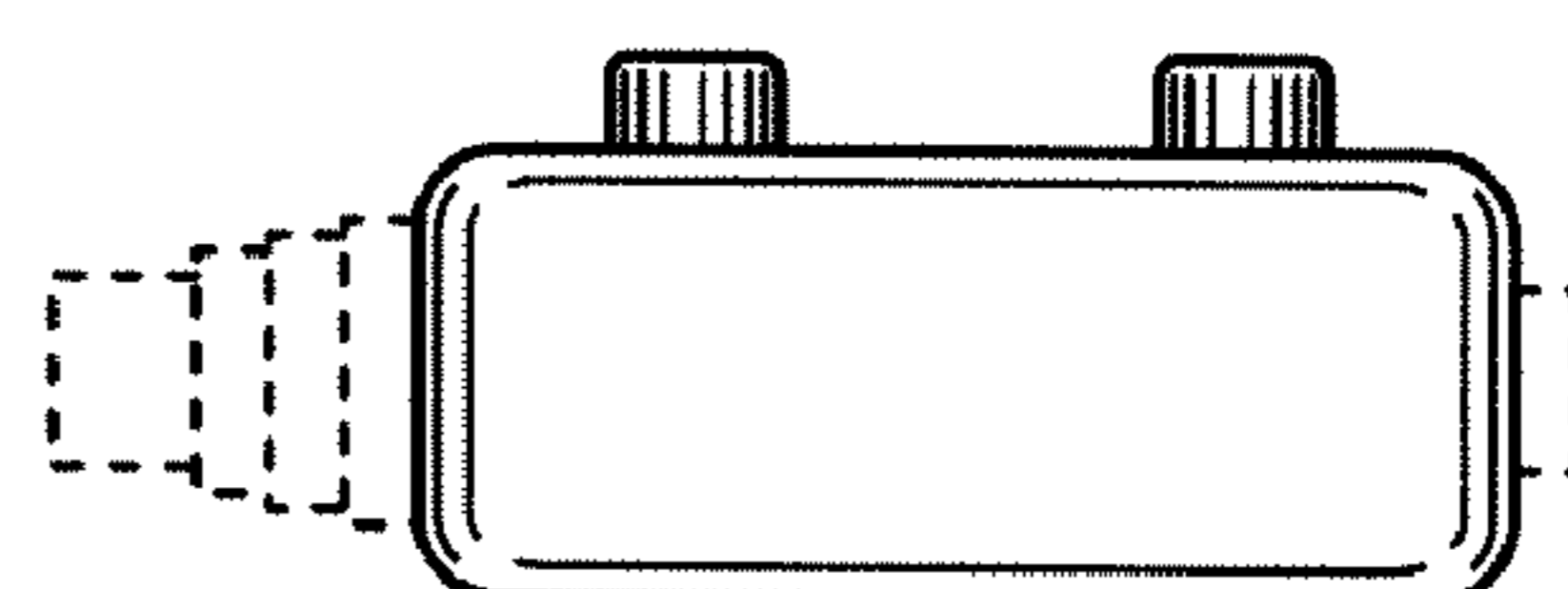

FIG. 64

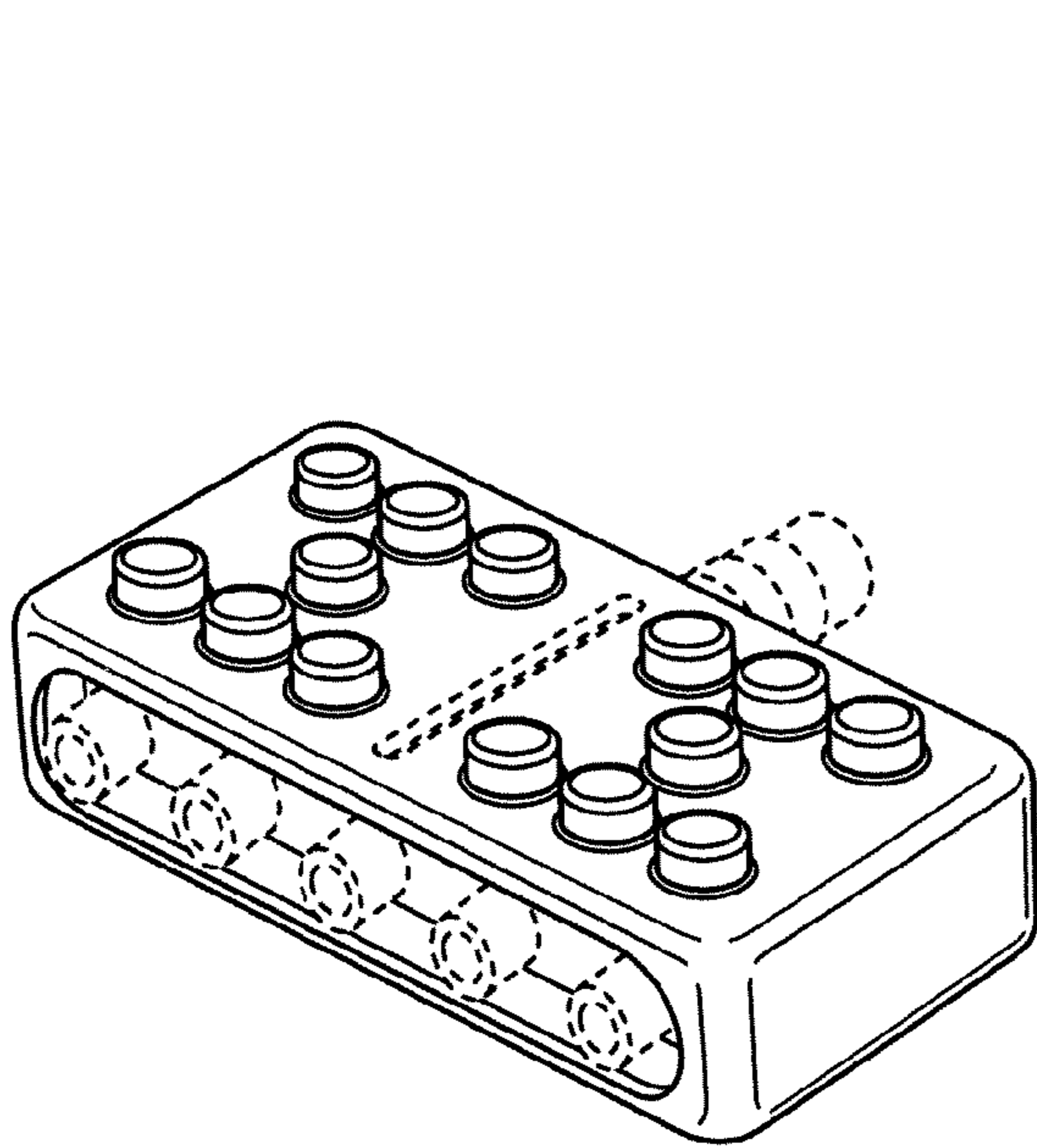

FIG. 65

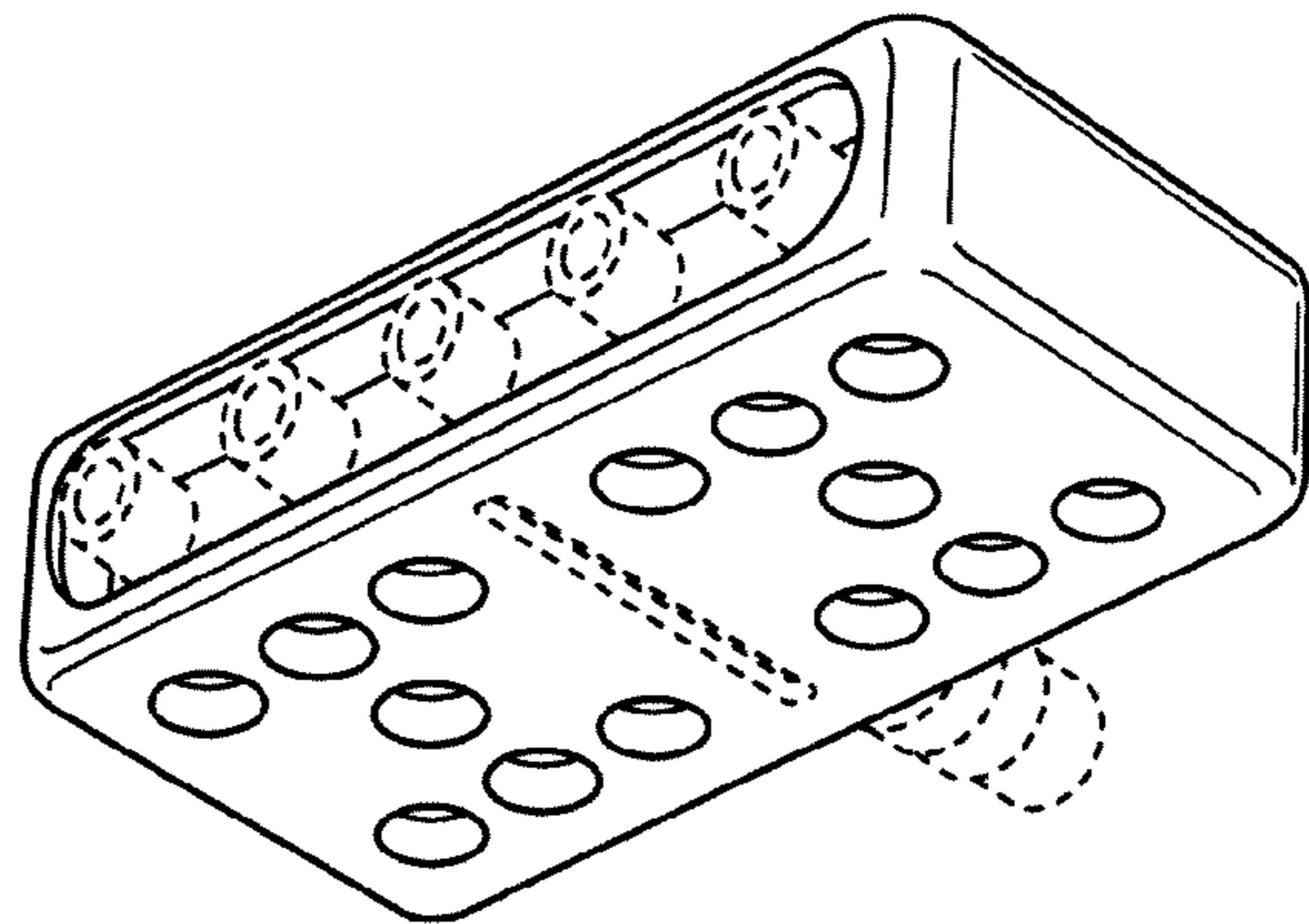

FIG. 66

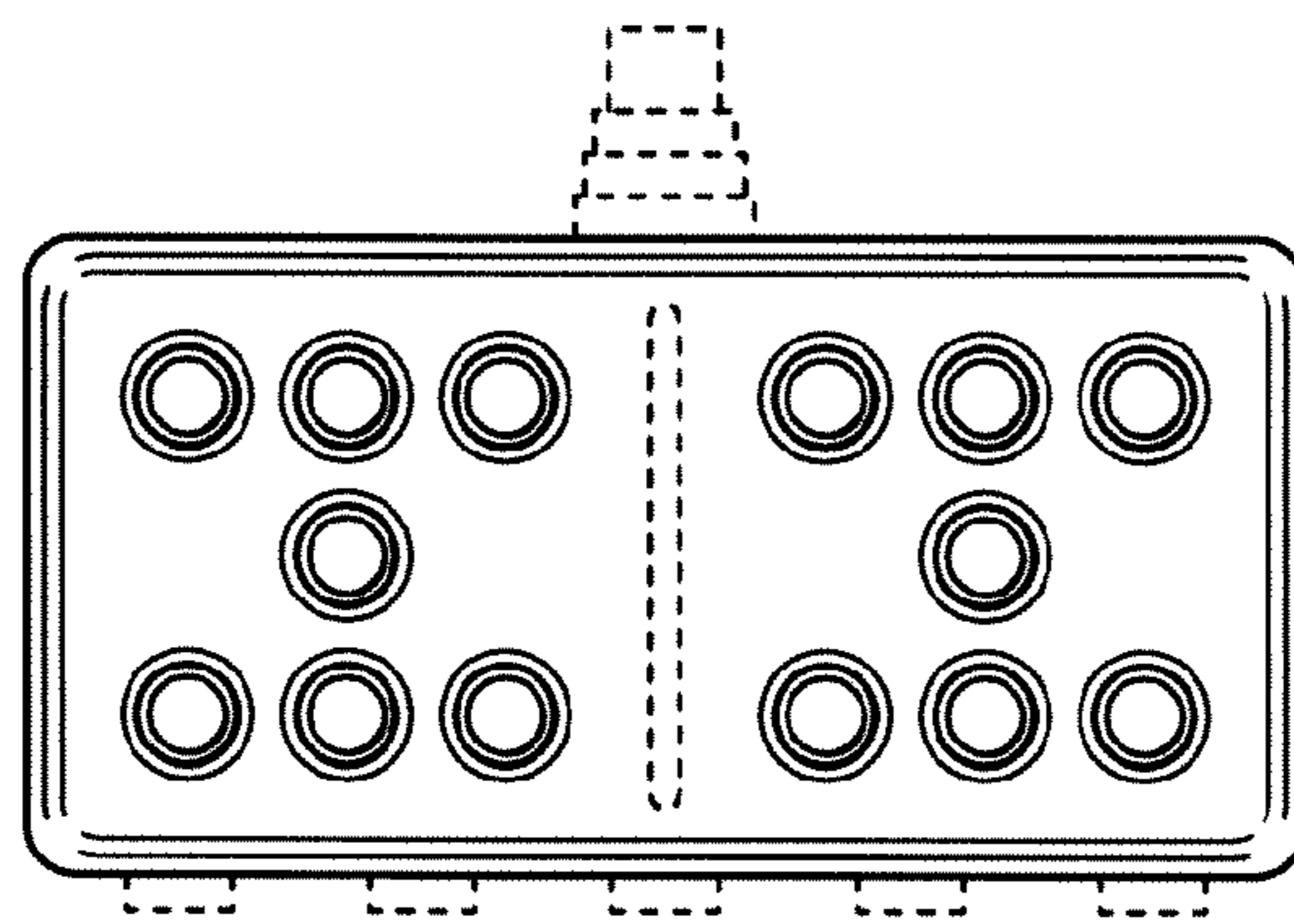

FIG. 67

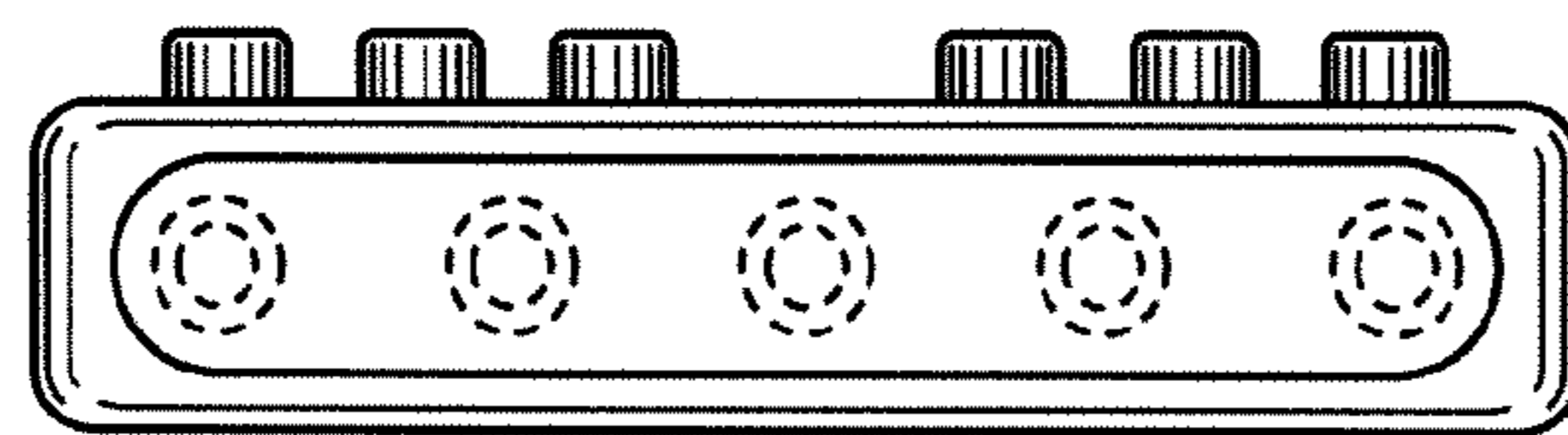

FIG. 68

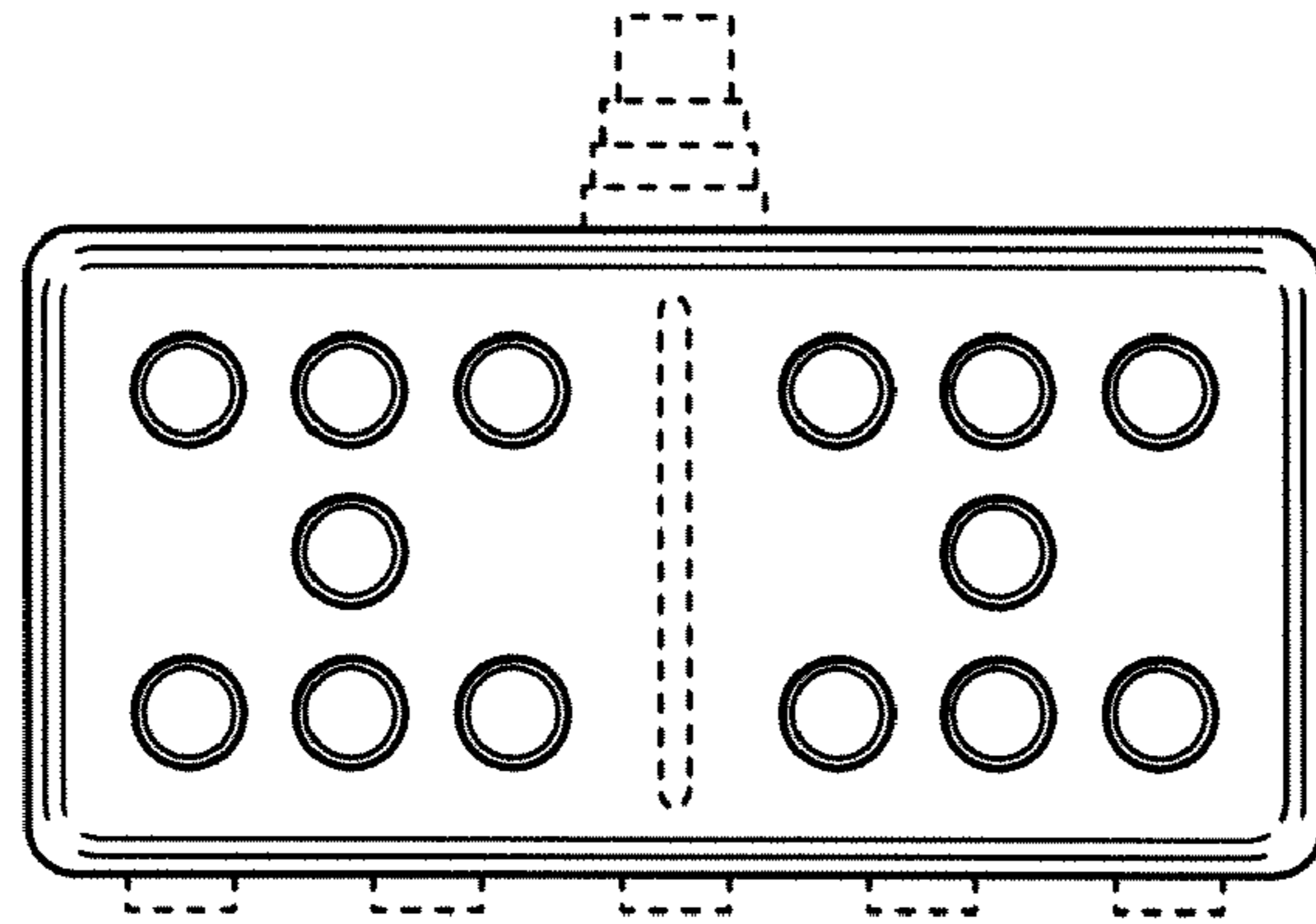

FIG. 69

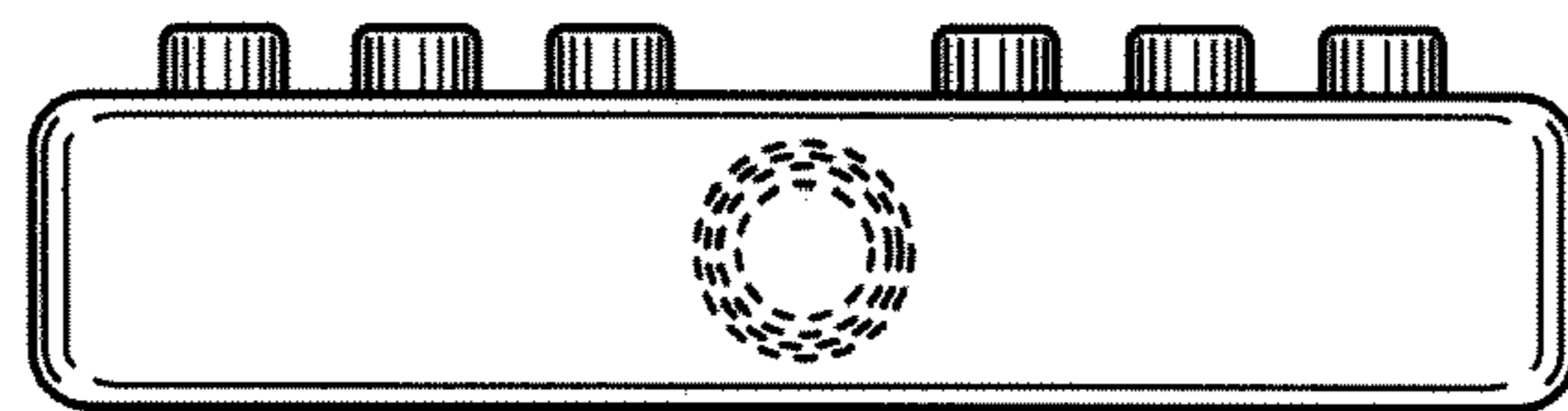

FIG. 70

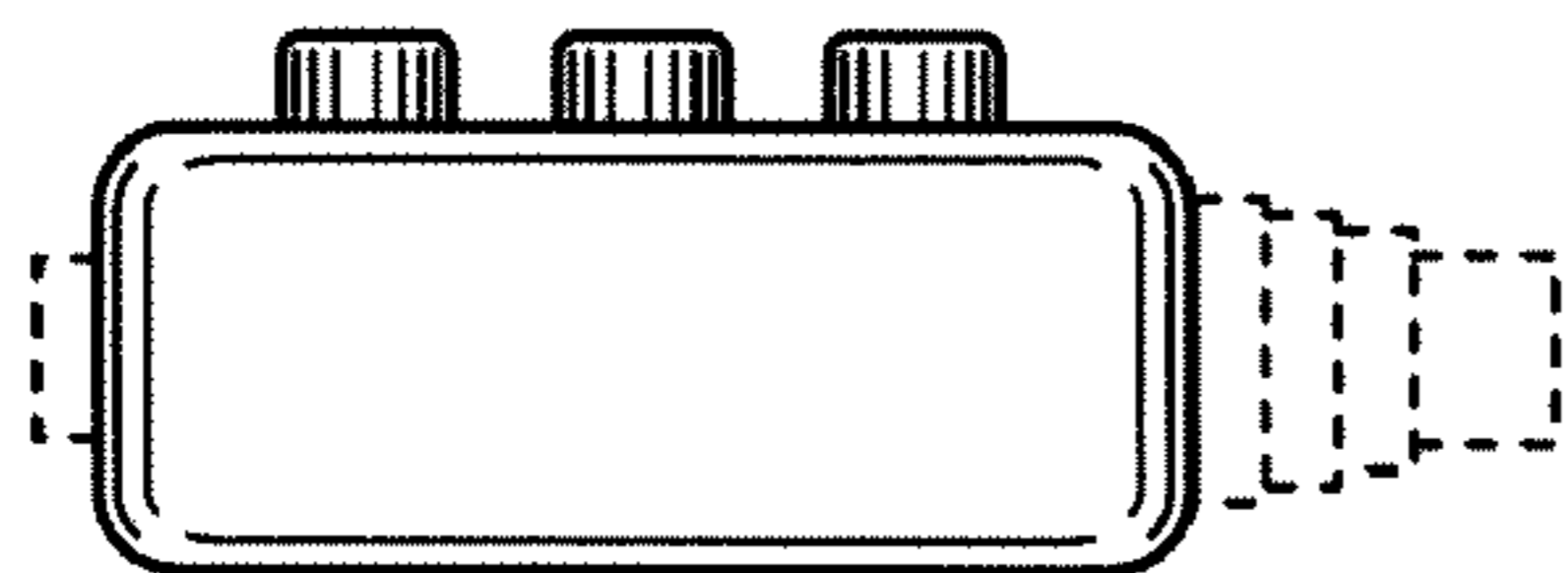

FIG. 71

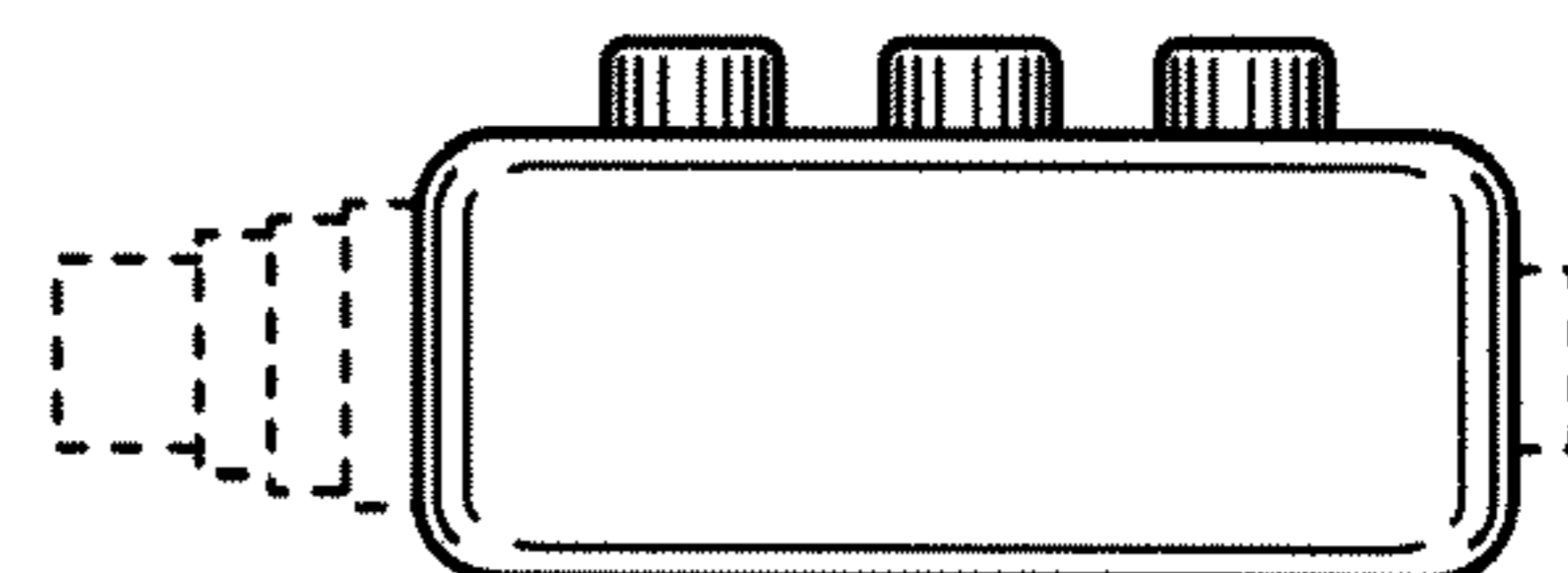

FIG. 72

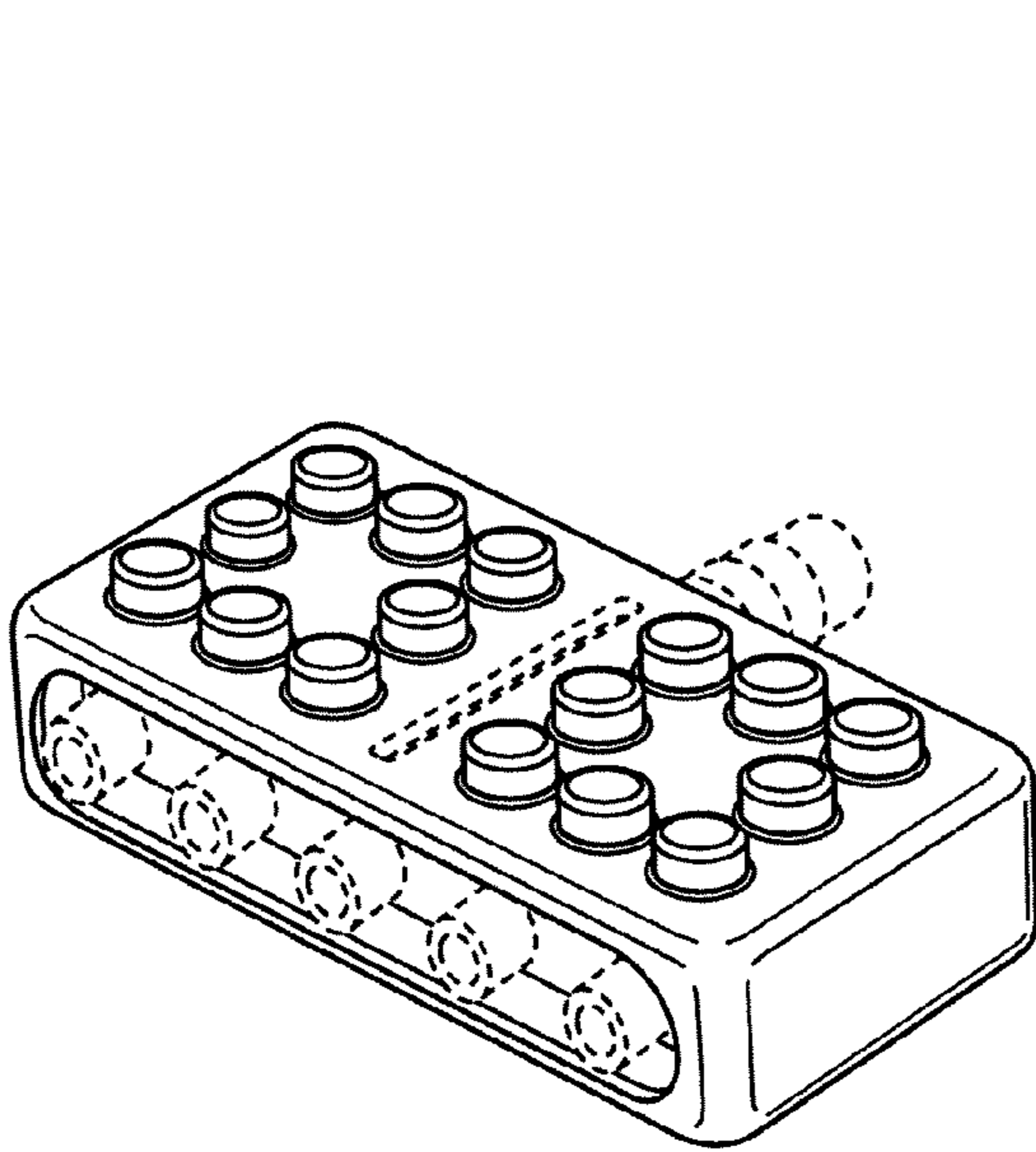

FIG. 73

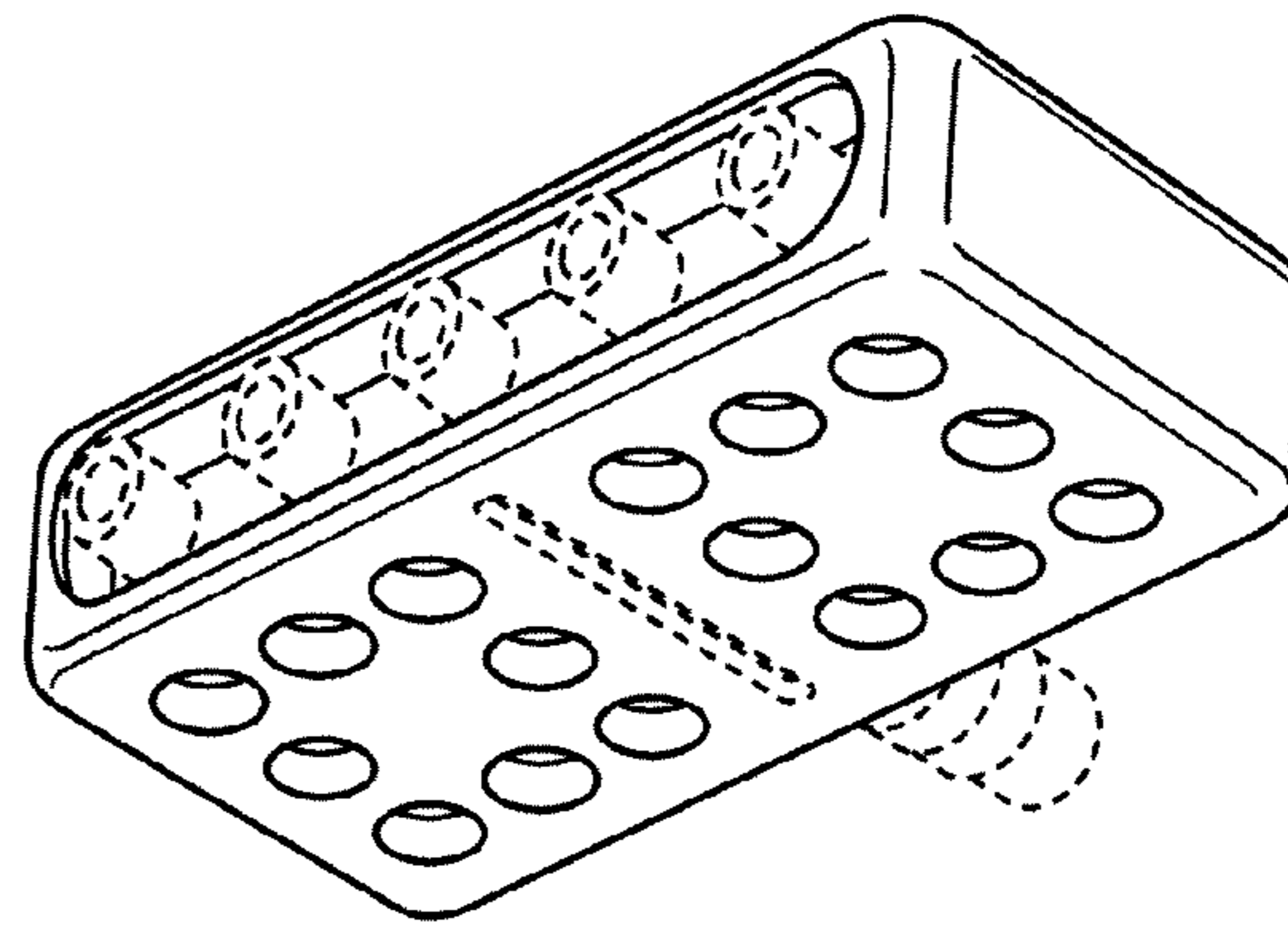

FIG. 74

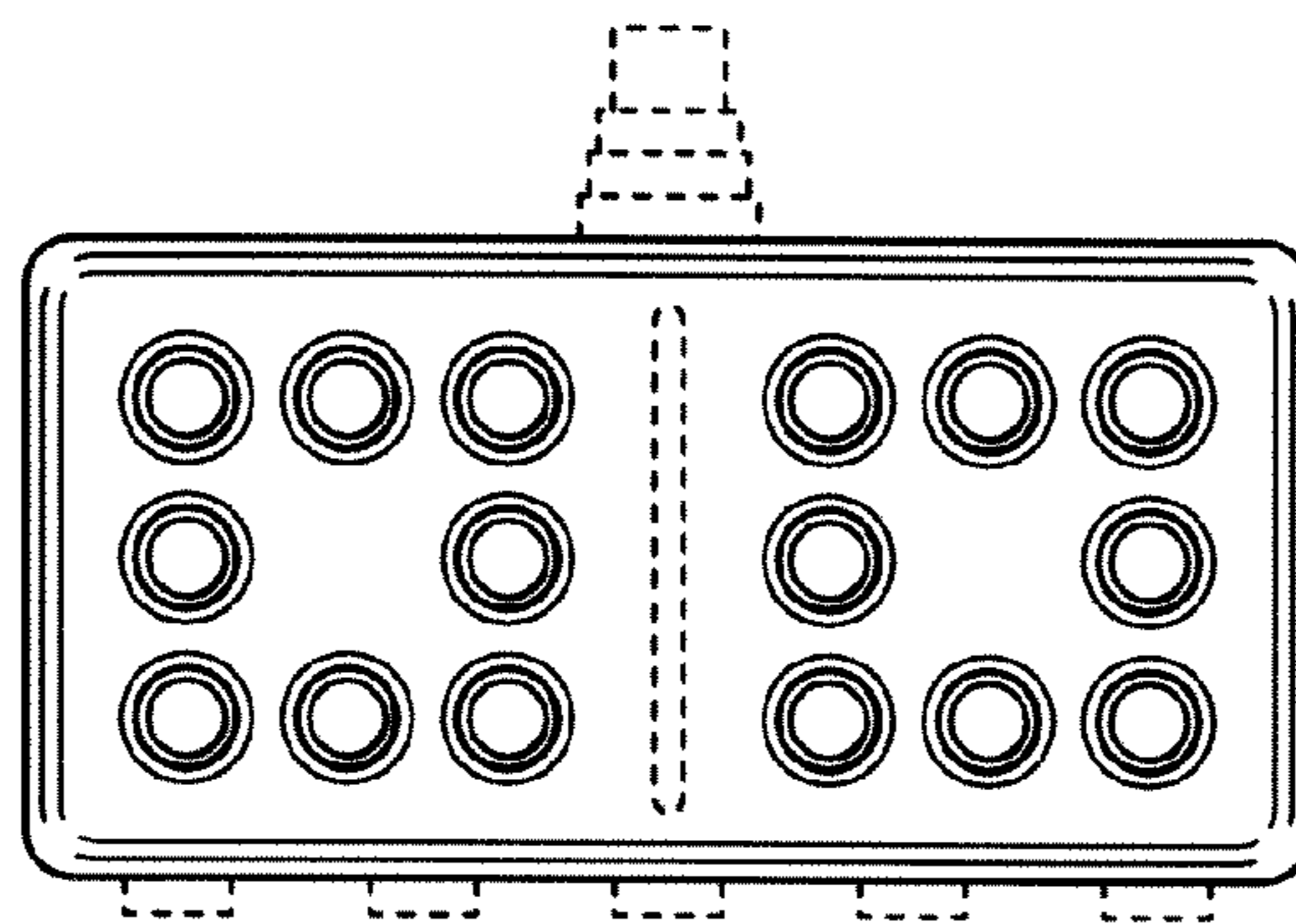

FIG. 75

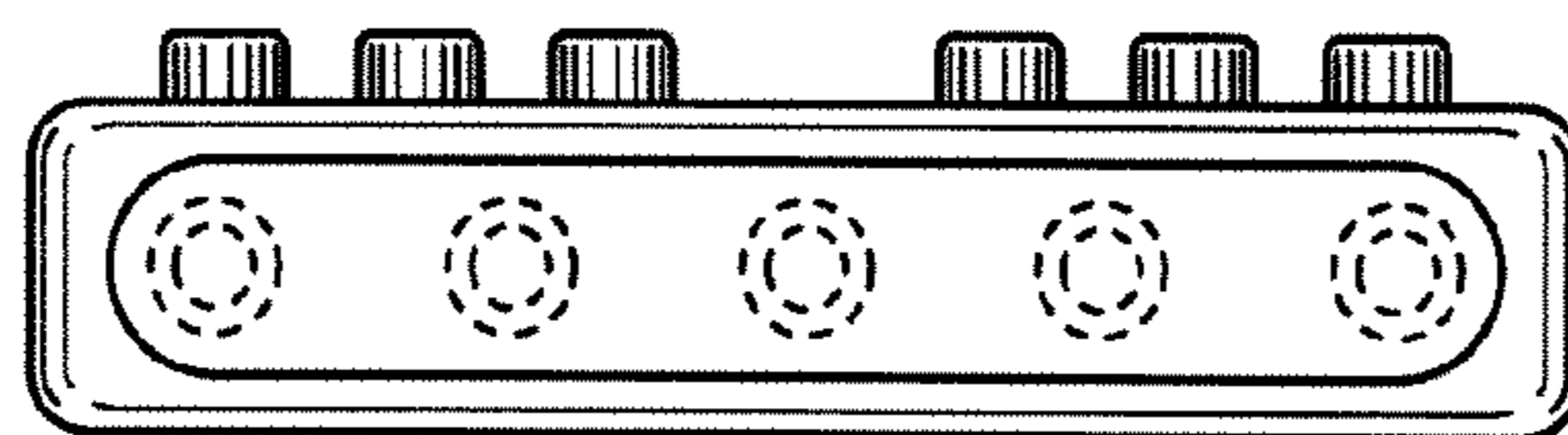

FIG. 76

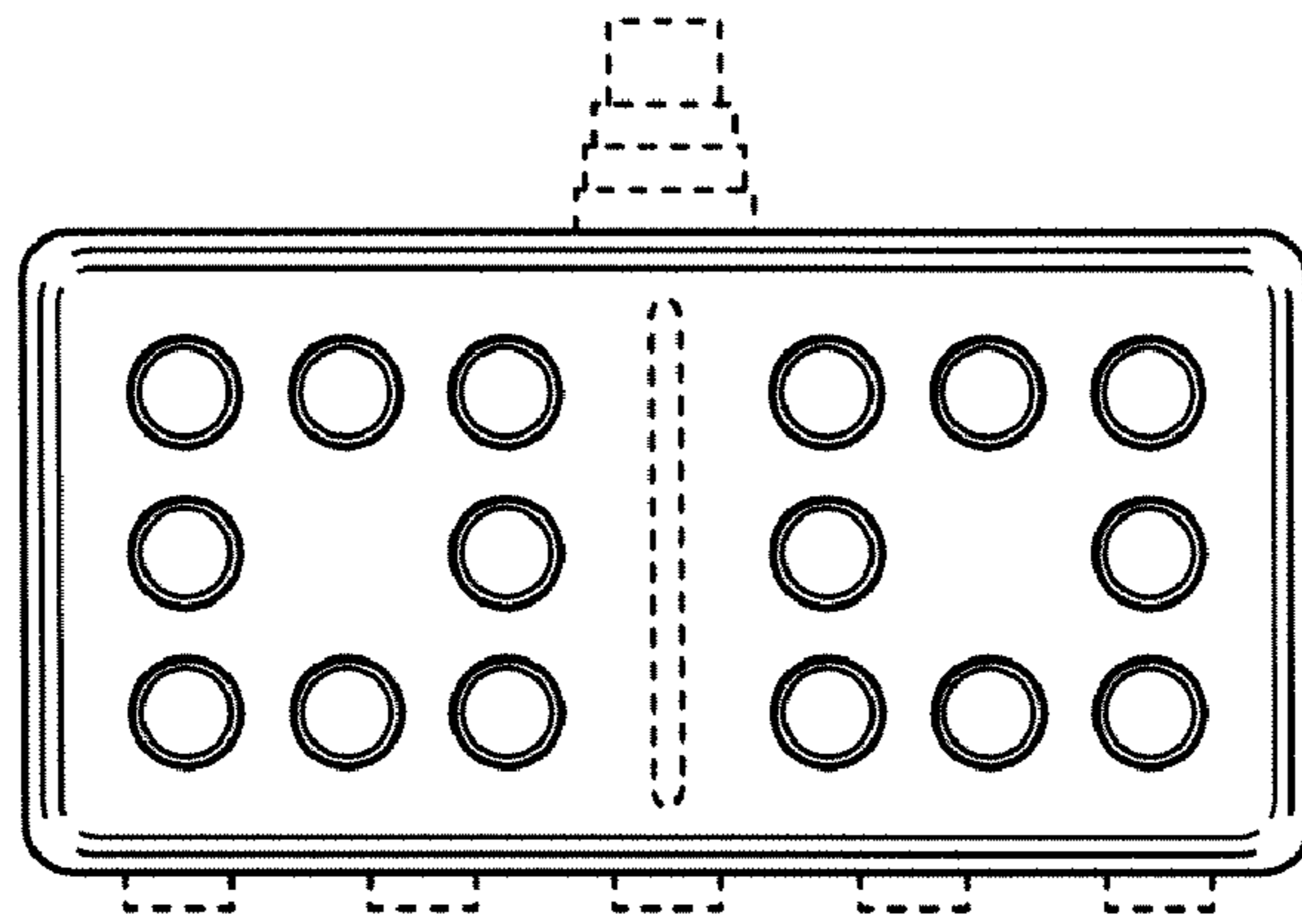

FIG. 77

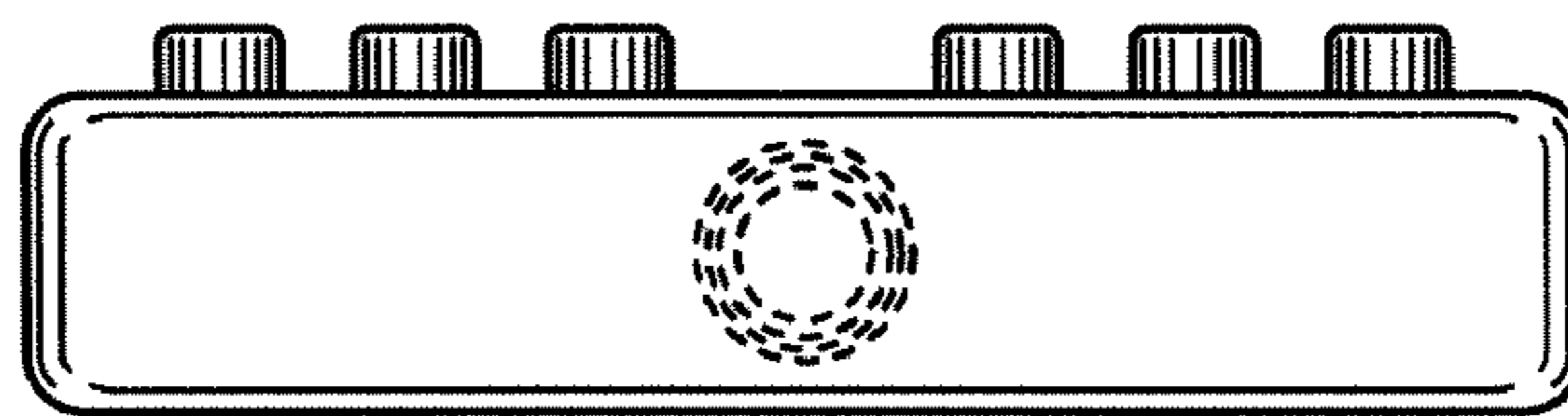

FIG. 78

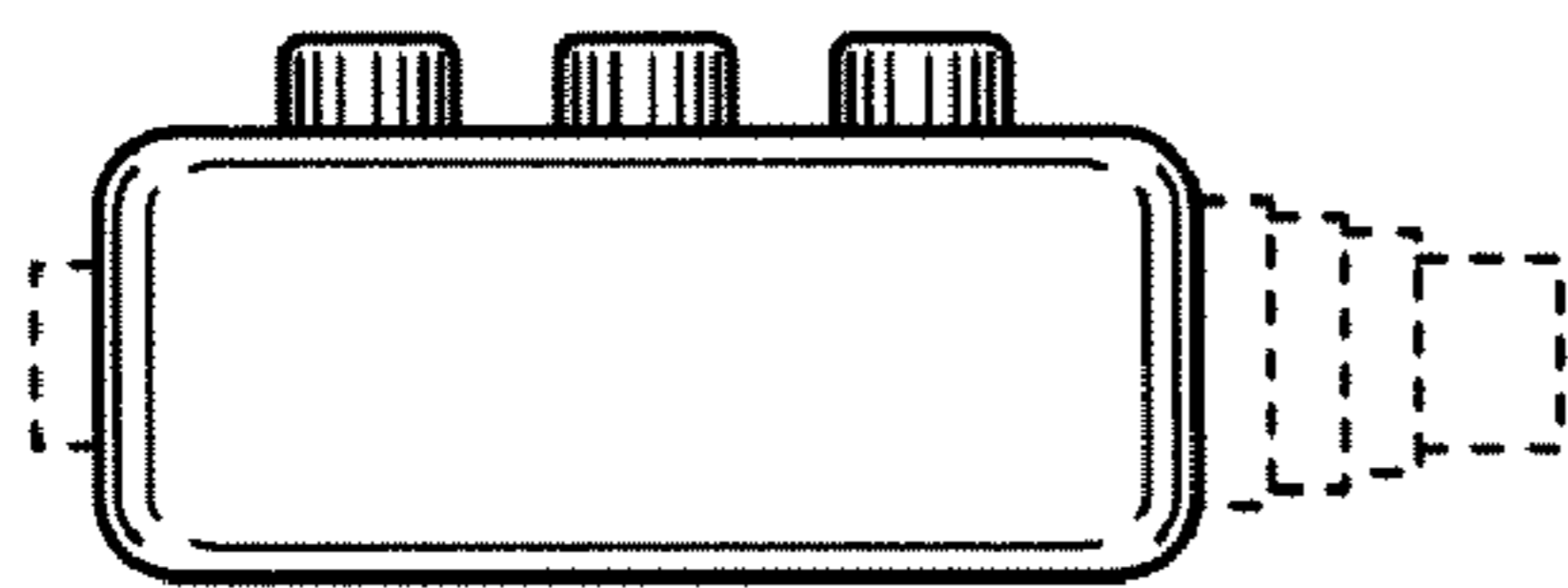

FIG. 79

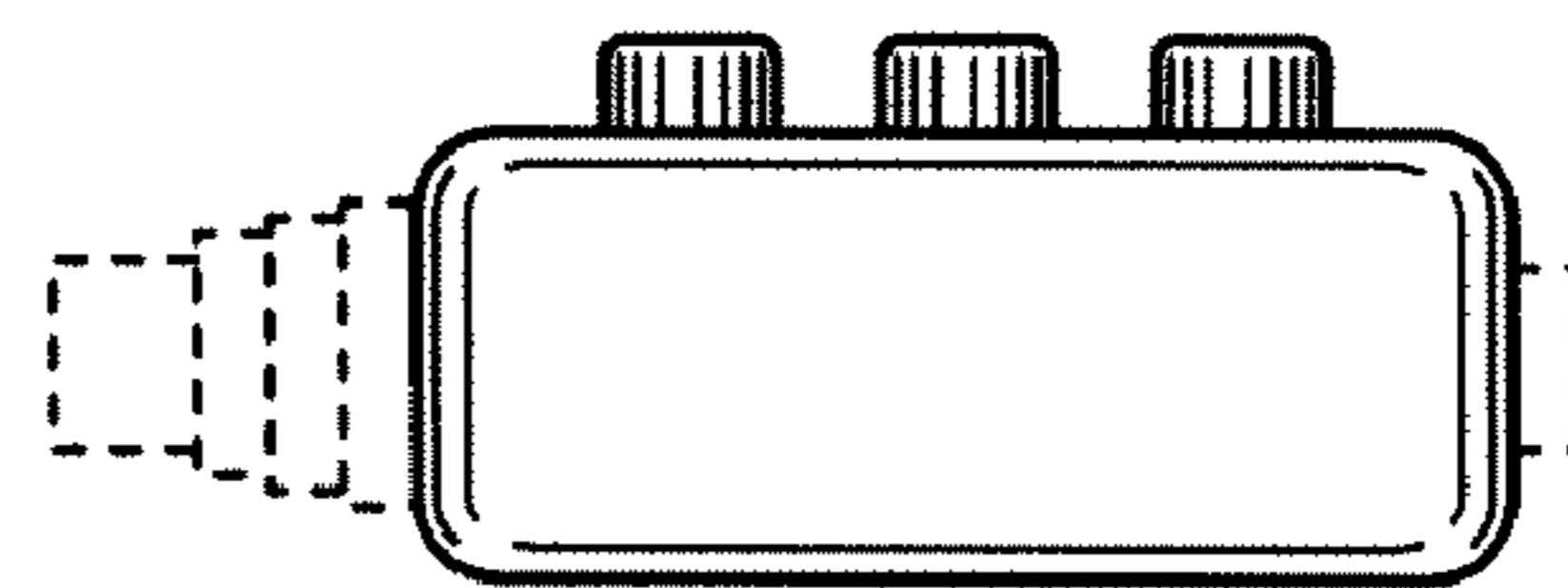

FIG. 80

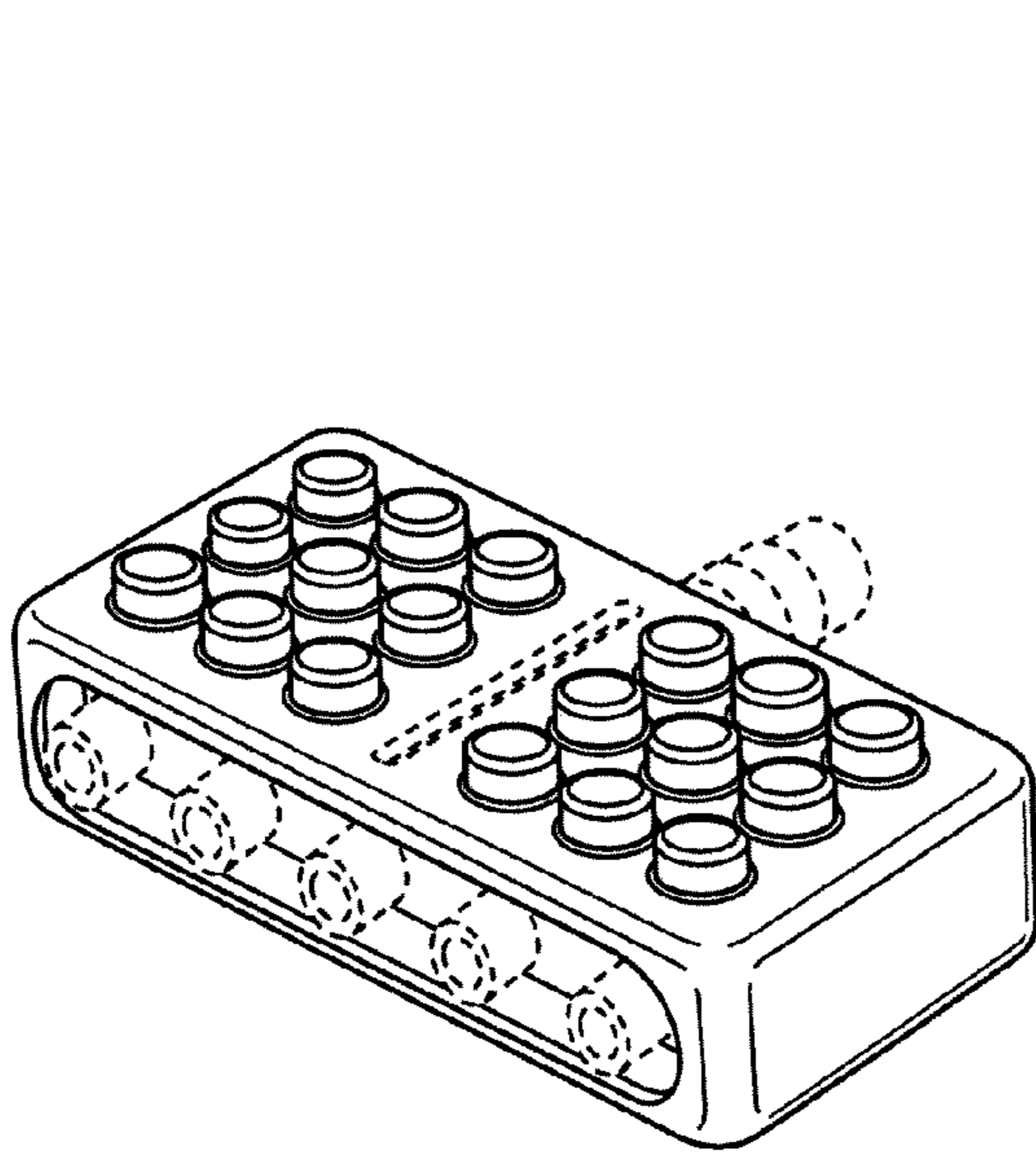

FIG. 81

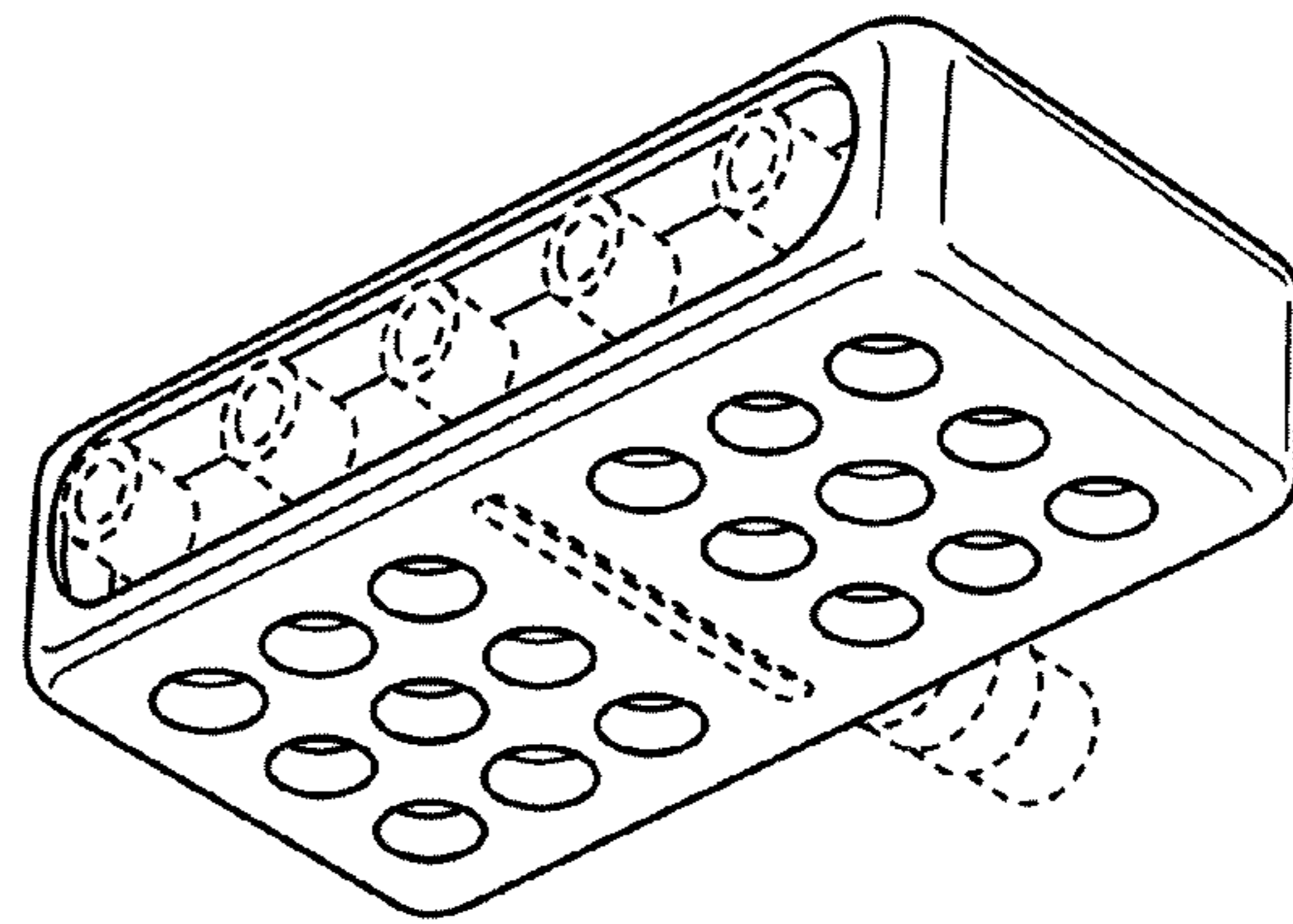

FIG. 82

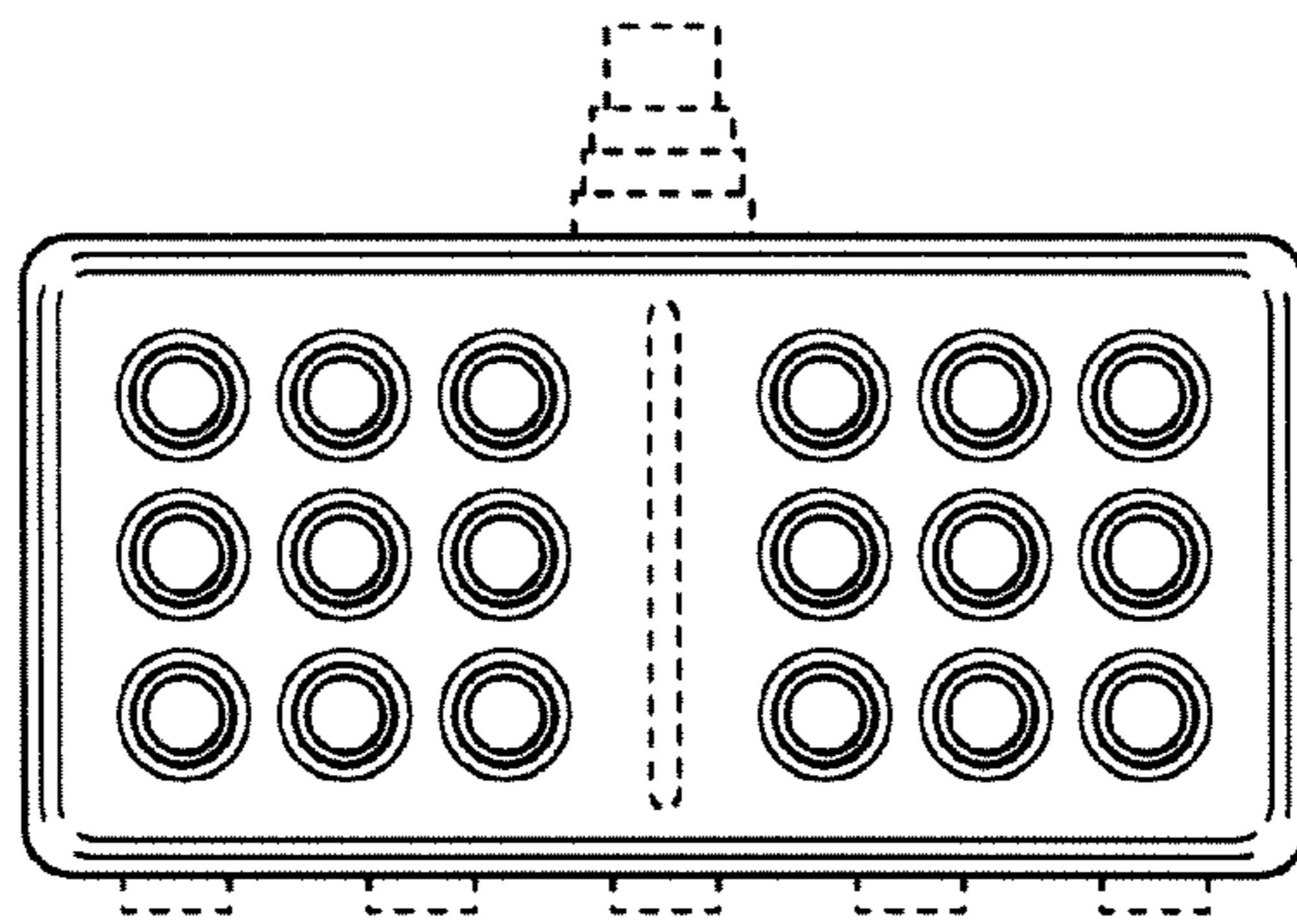

FIG. 83

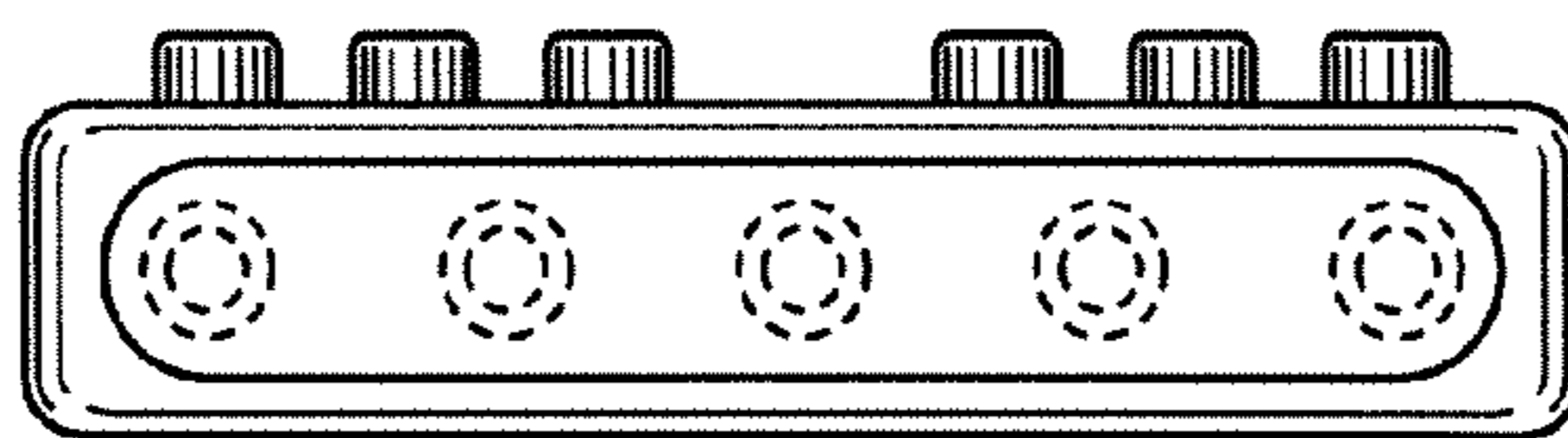

FIG. 84

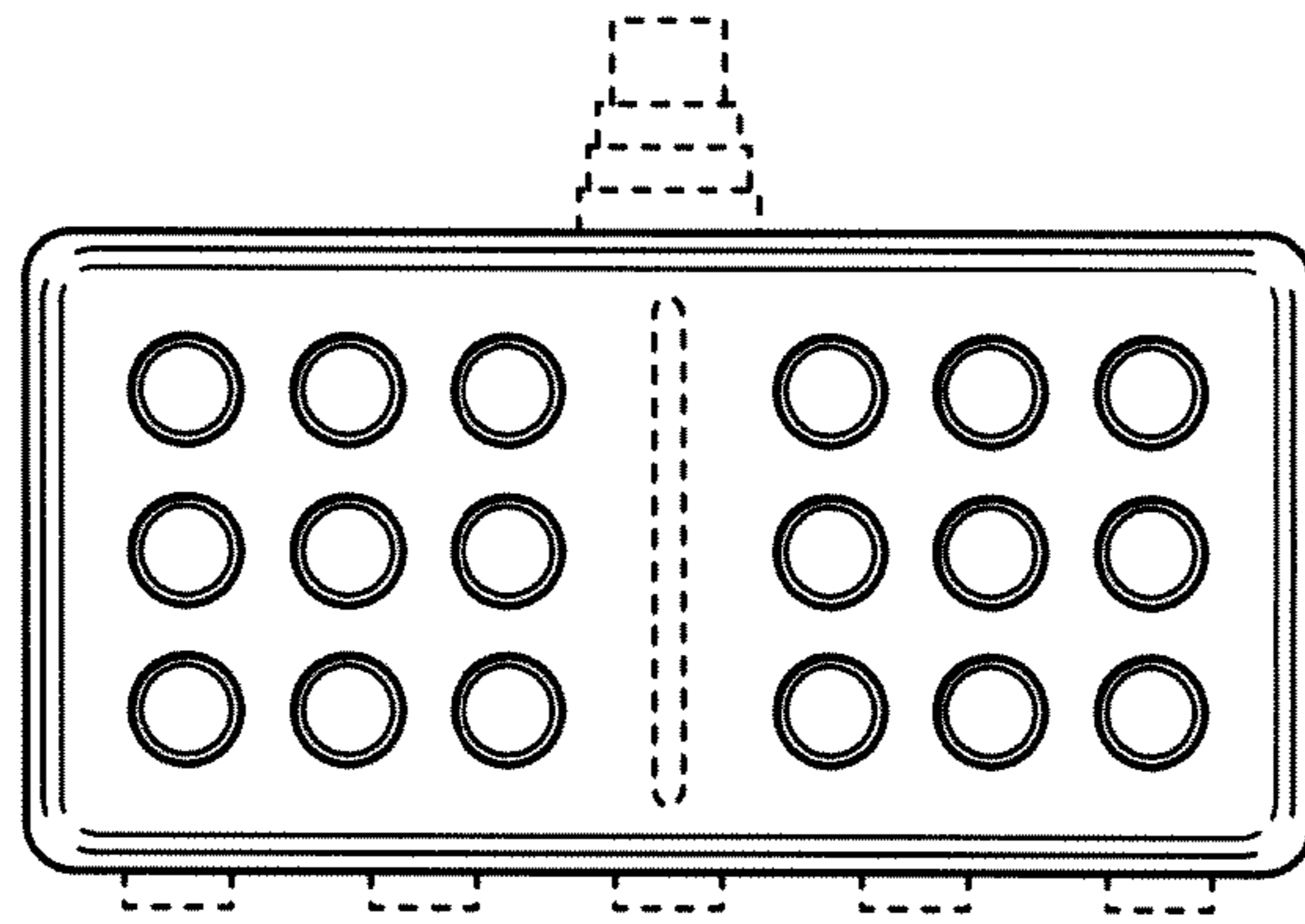

FIG. 85

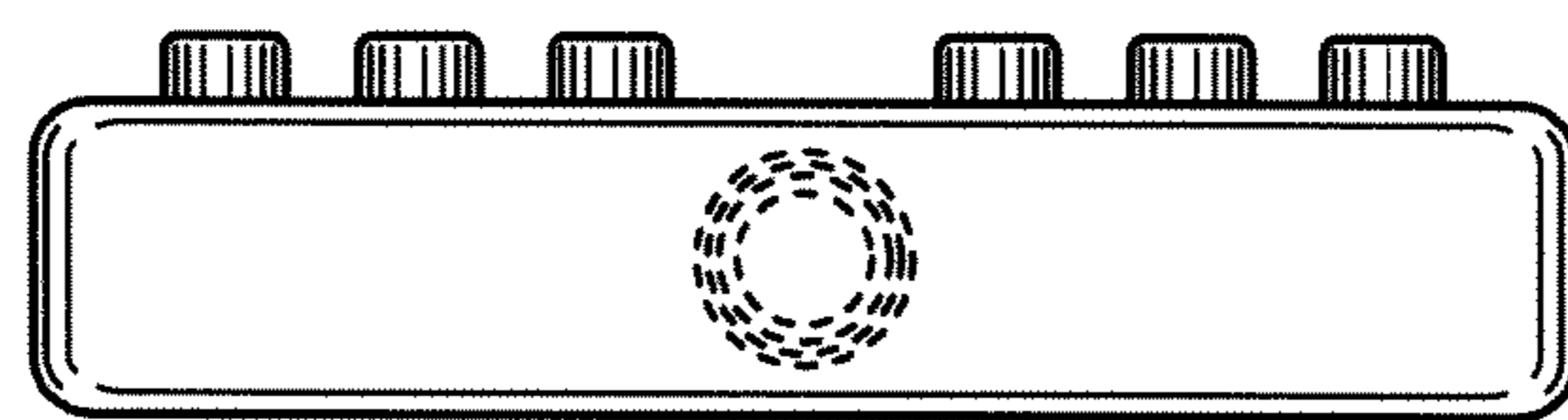

FIG. 86

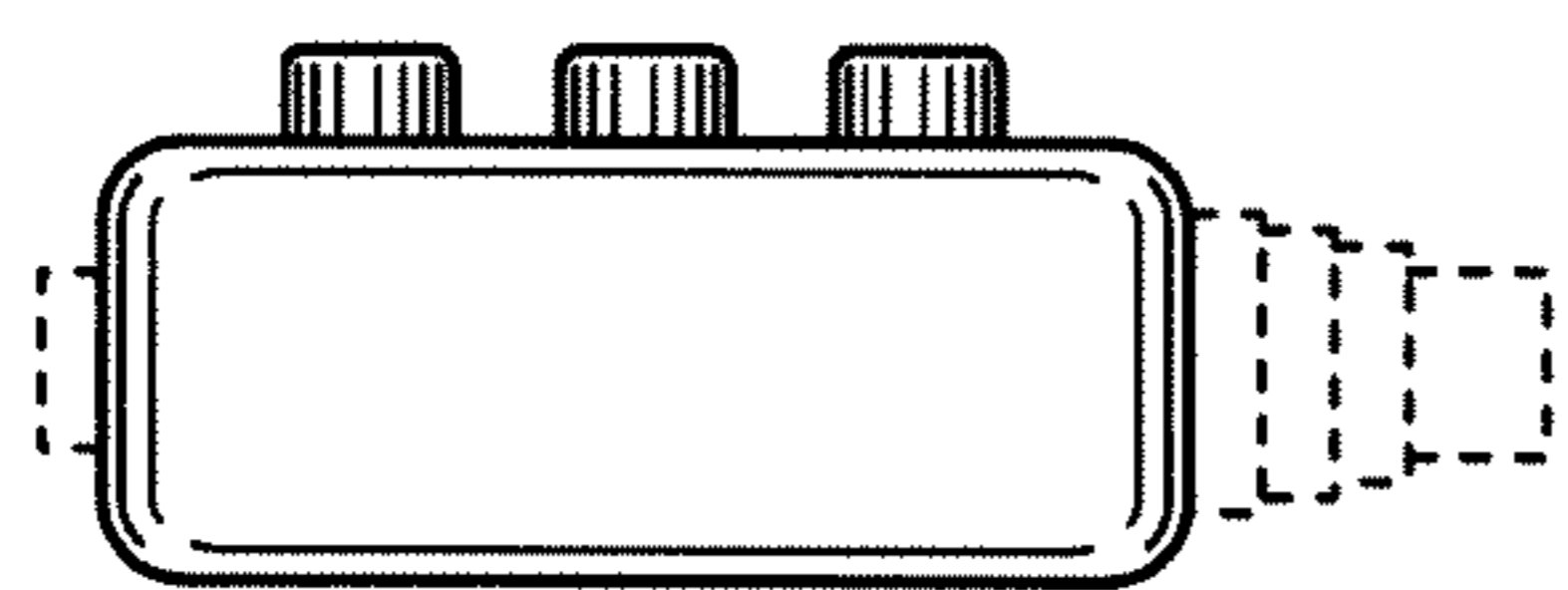

FIG. 87

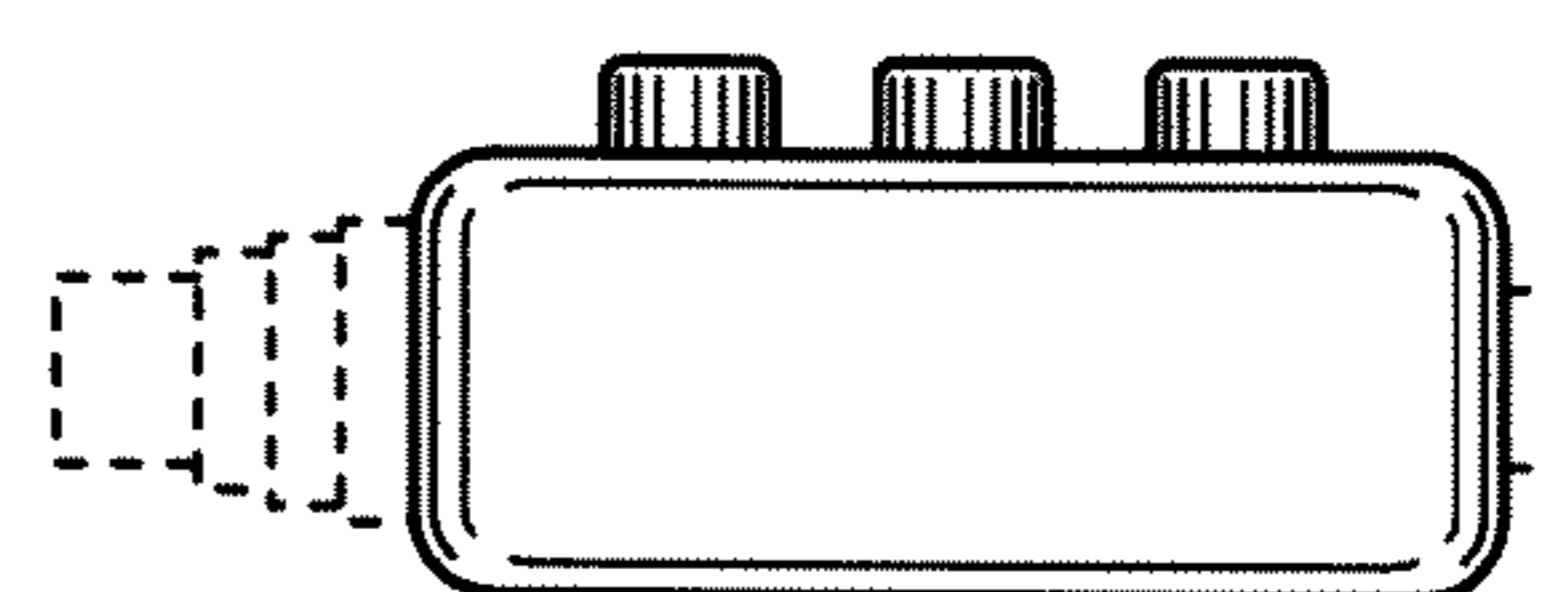

FIG. 88

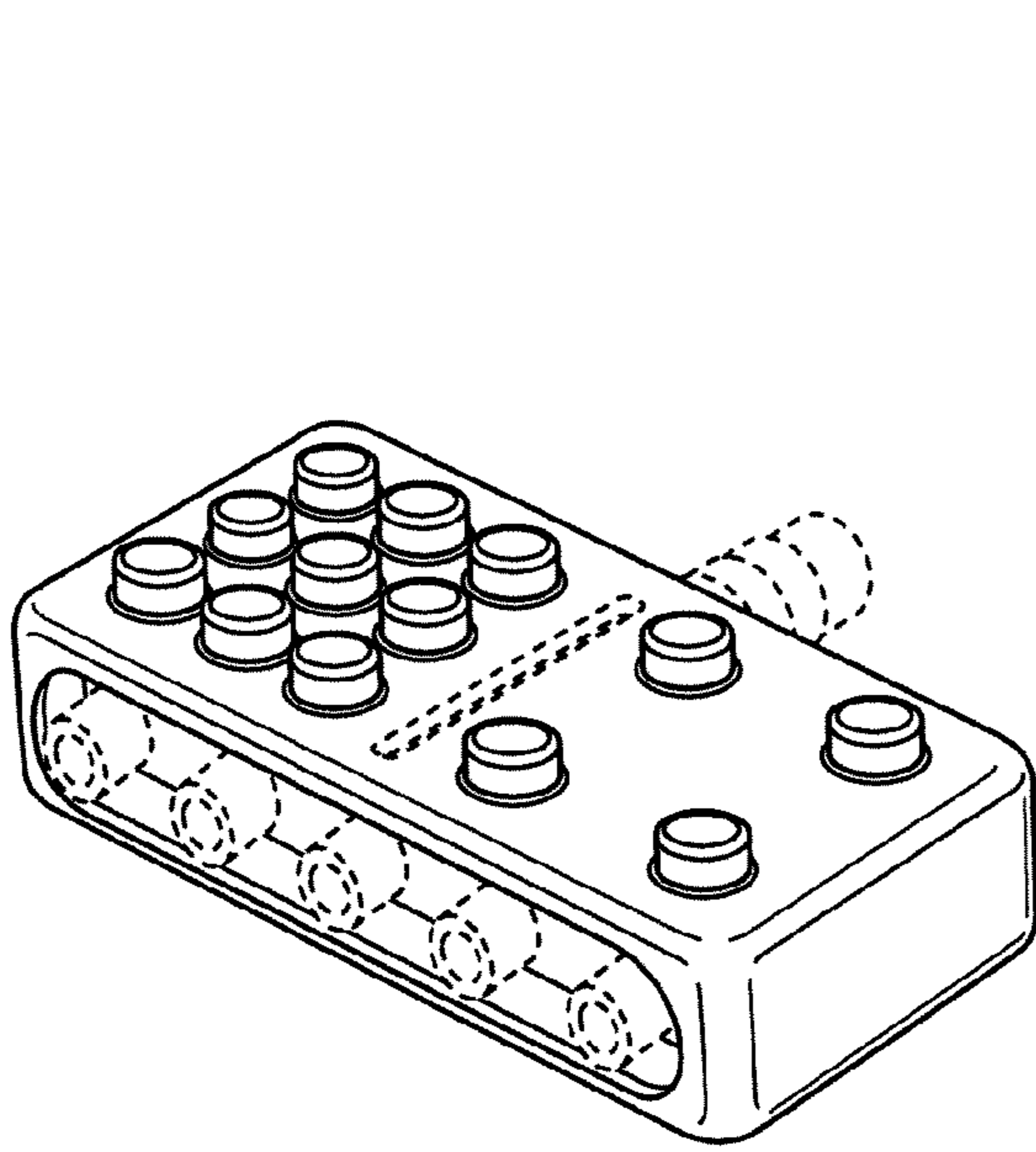

FIG. 89

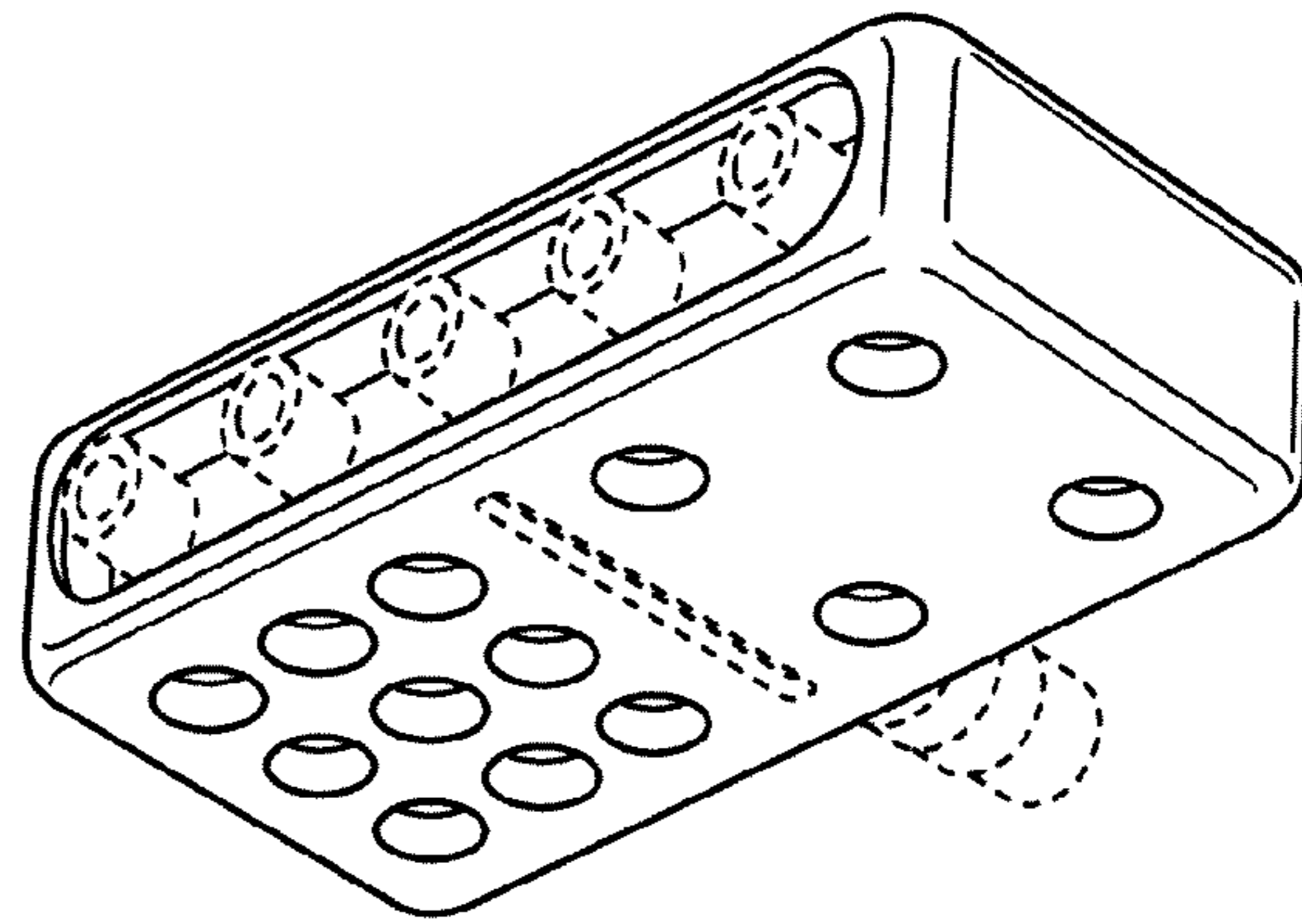

FIG. 90

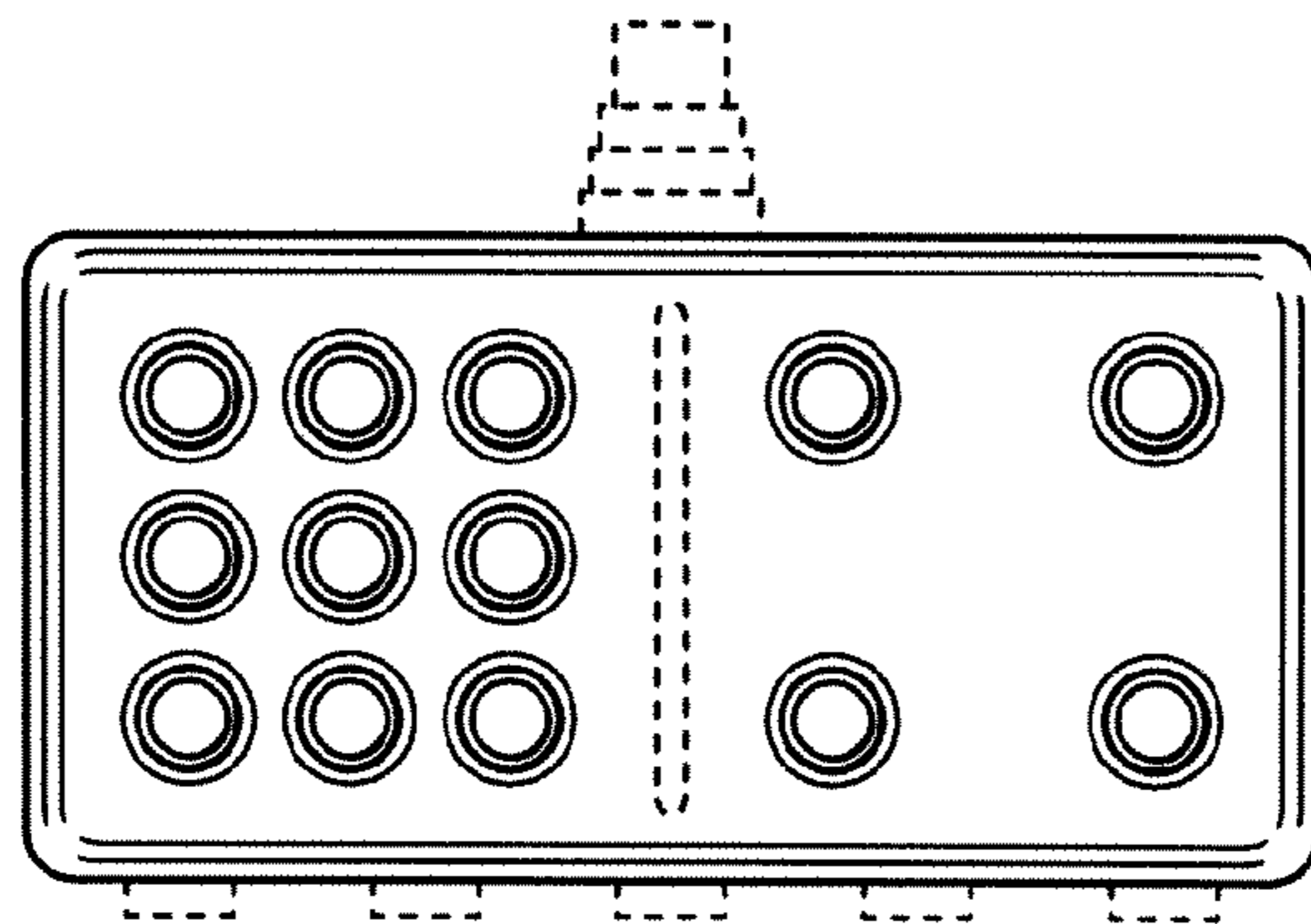

FIG. 91

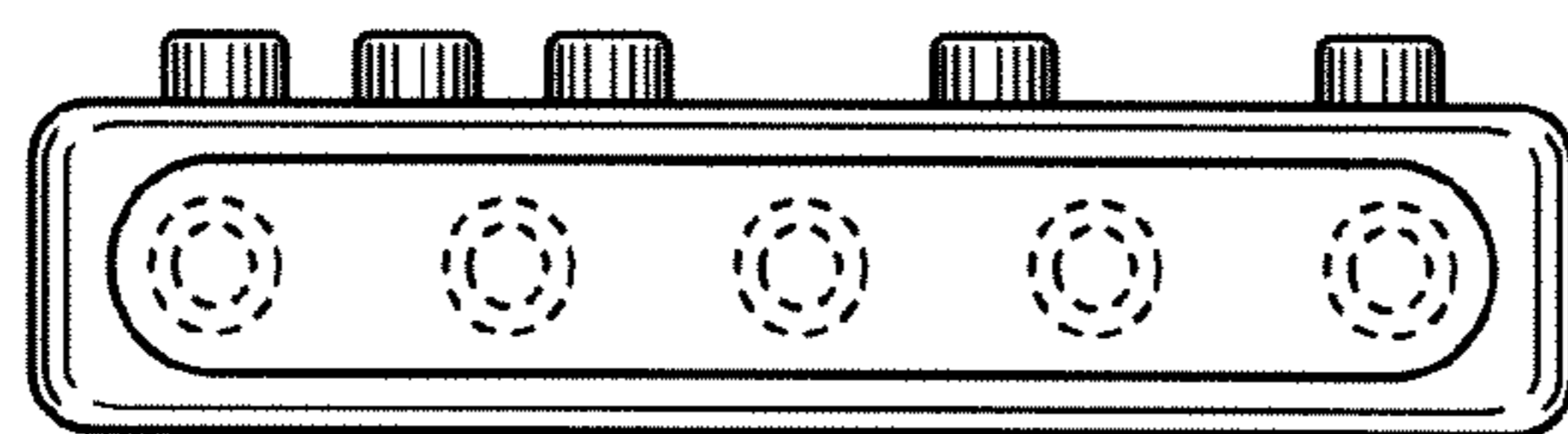

FIG. 92

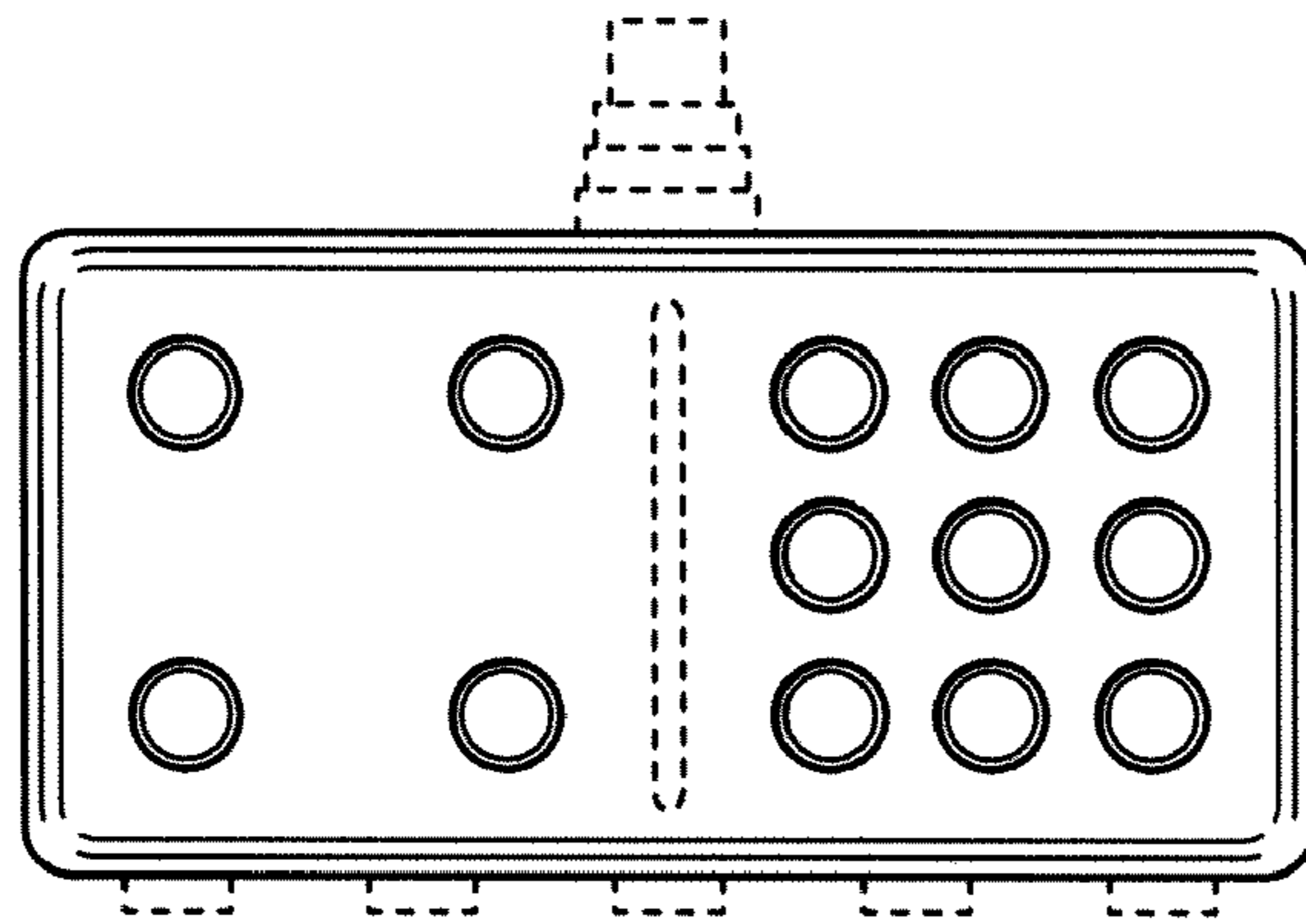

FIG. 93

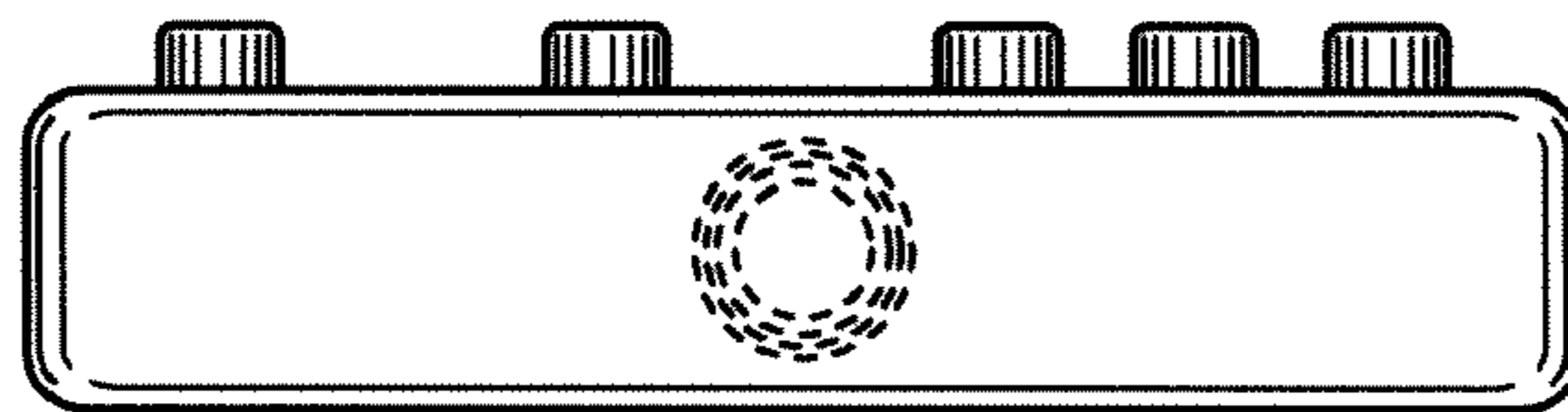

FIG. 94

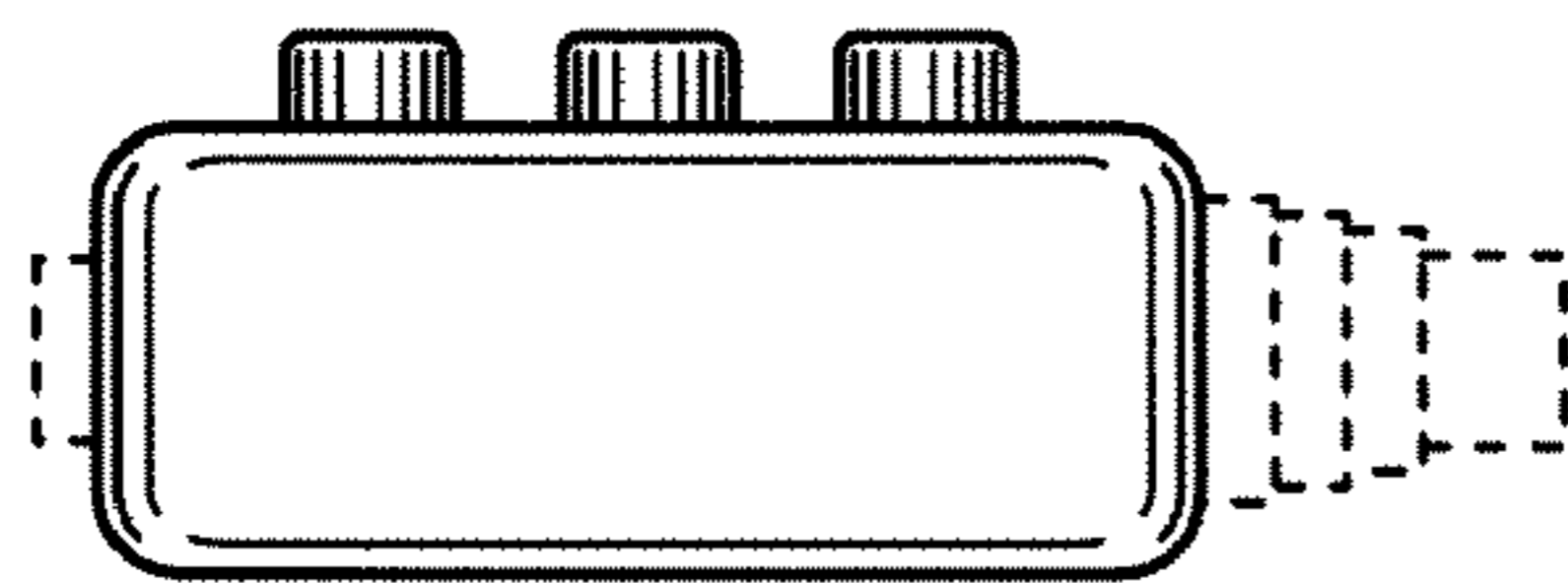

FIG. 95

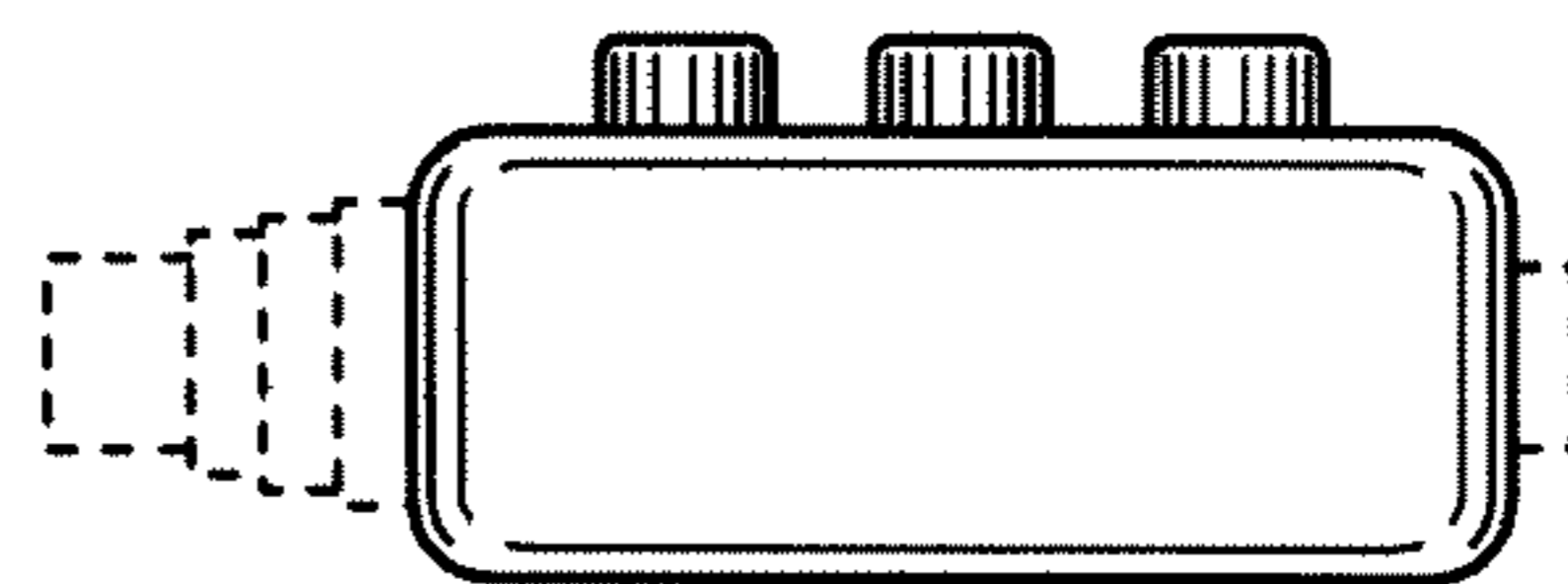

FIG. 96

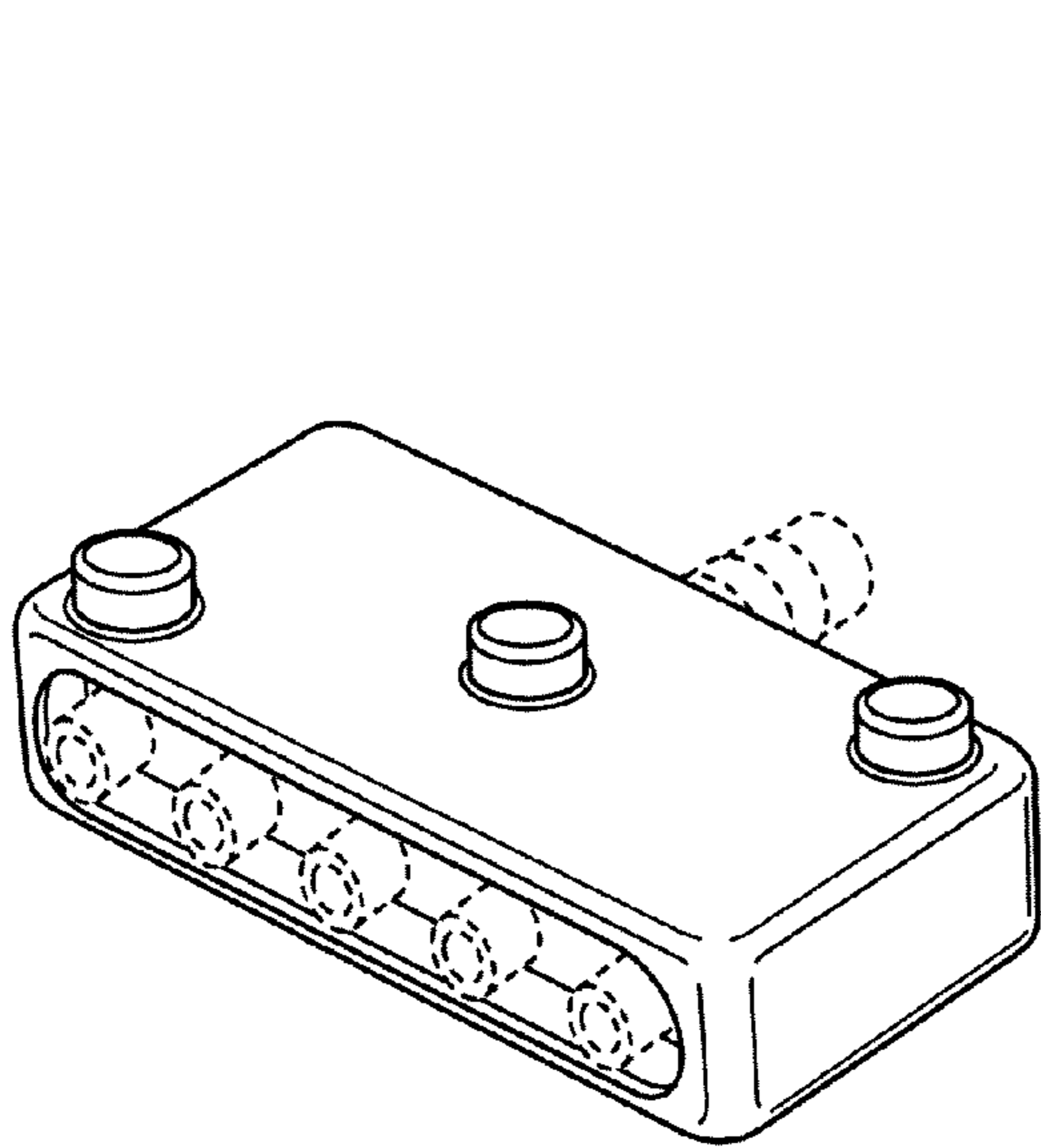

FIG. 97

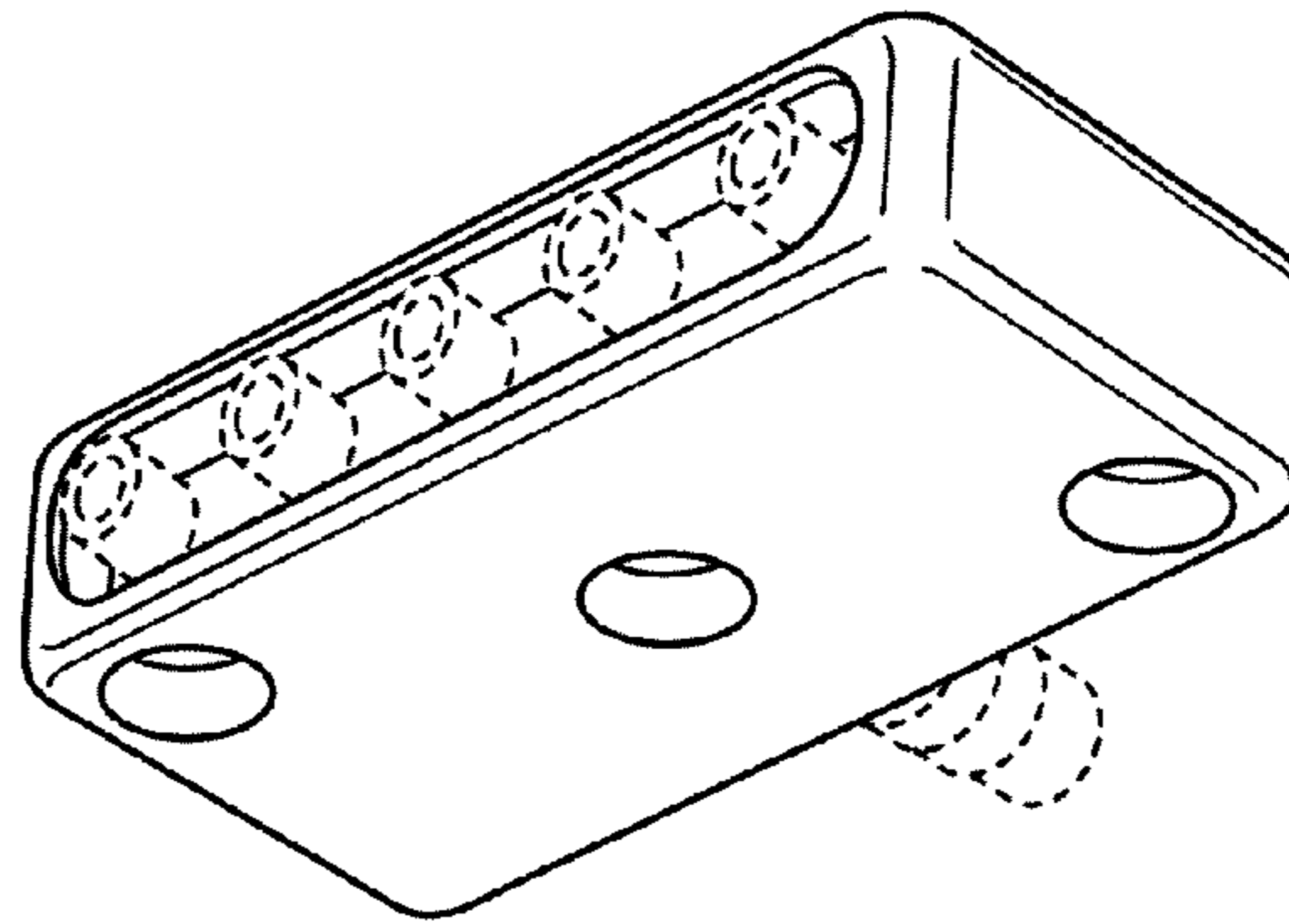

FIG. 98

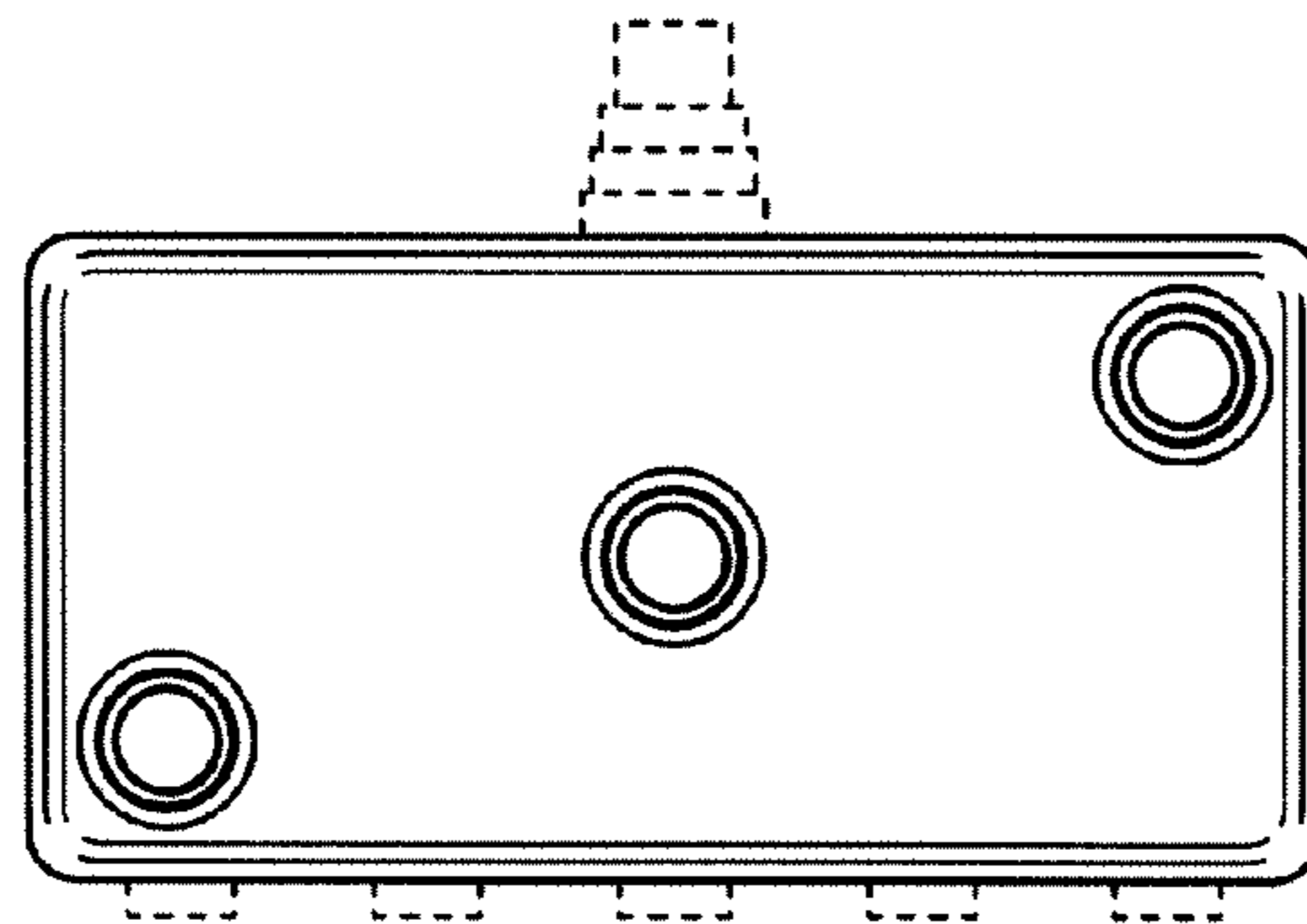

FIG. 99

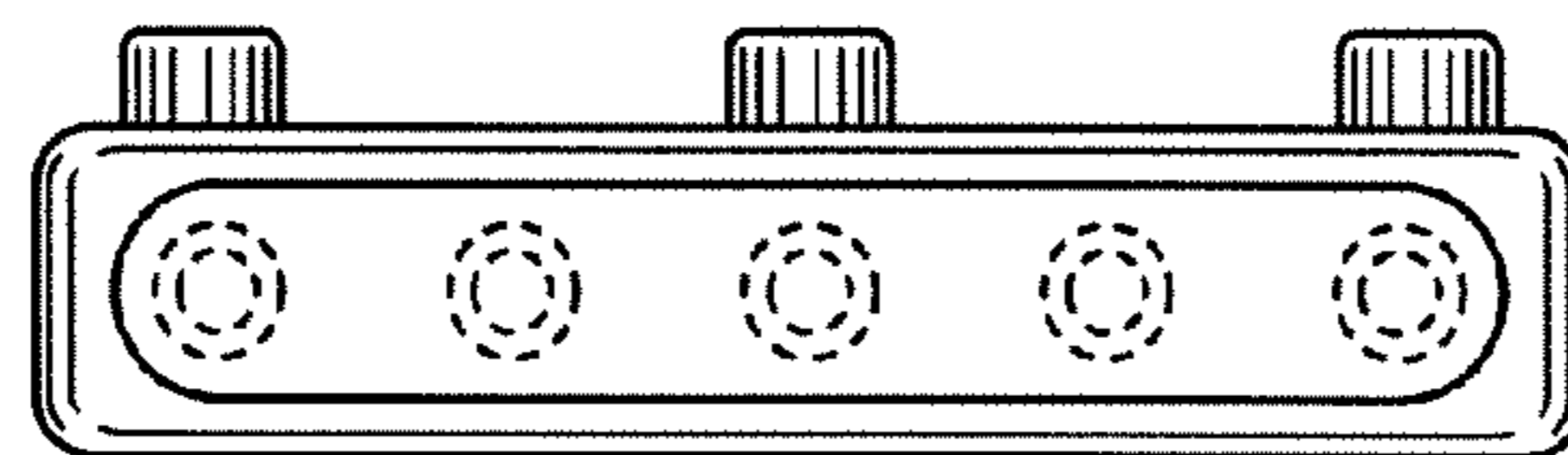

FIG. 100

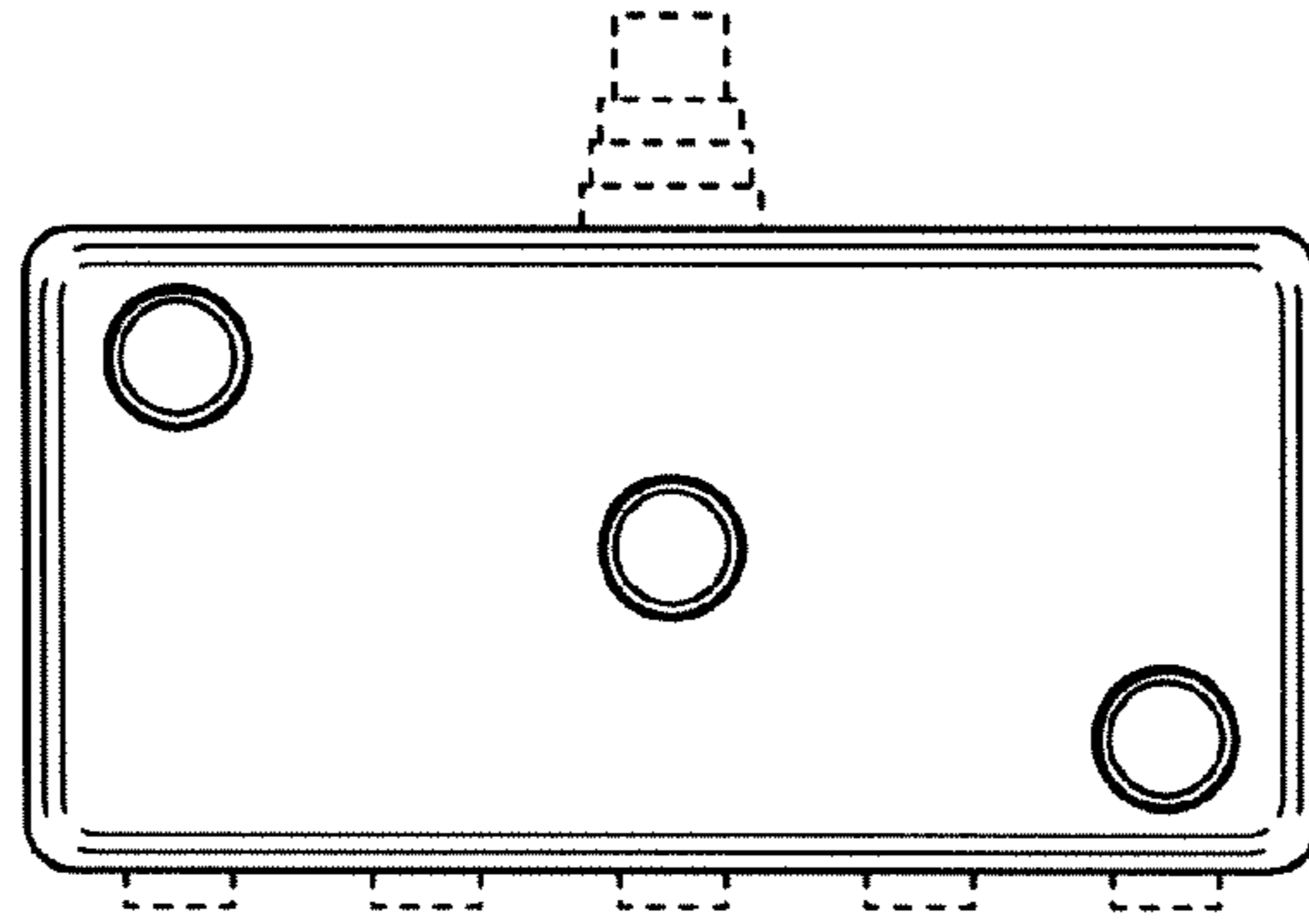

FIG. 101

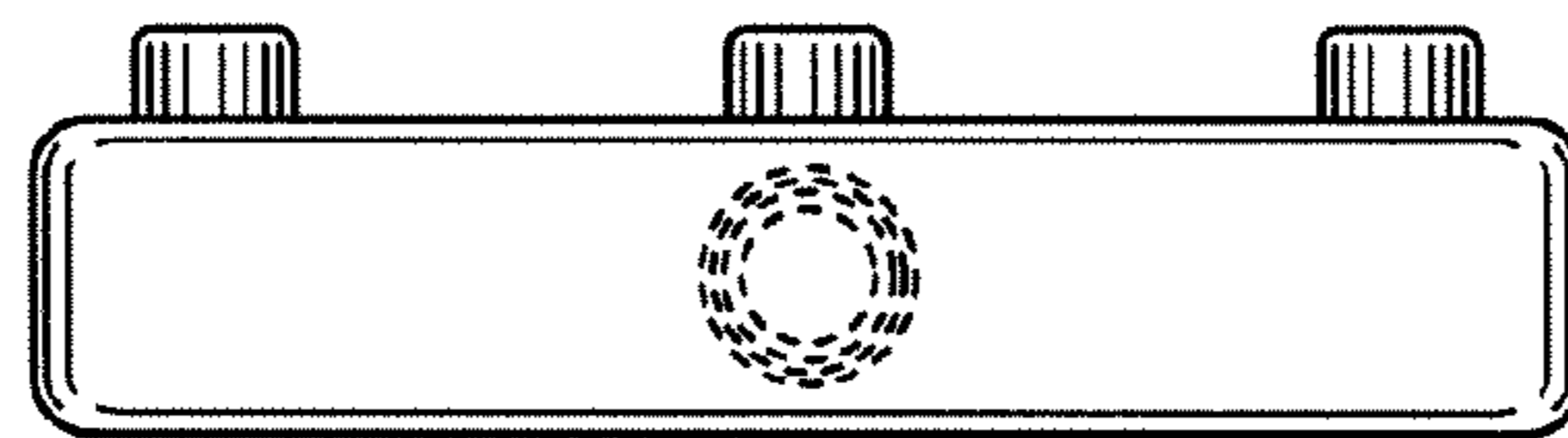

FIG. 102

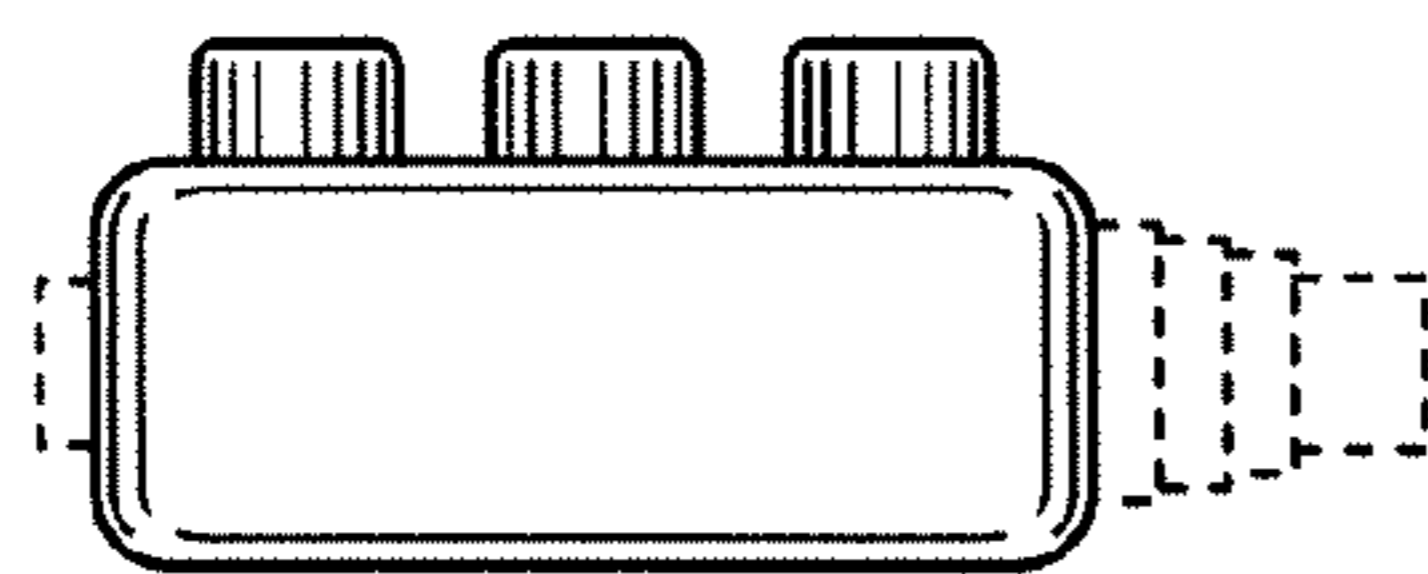

FIG. 103

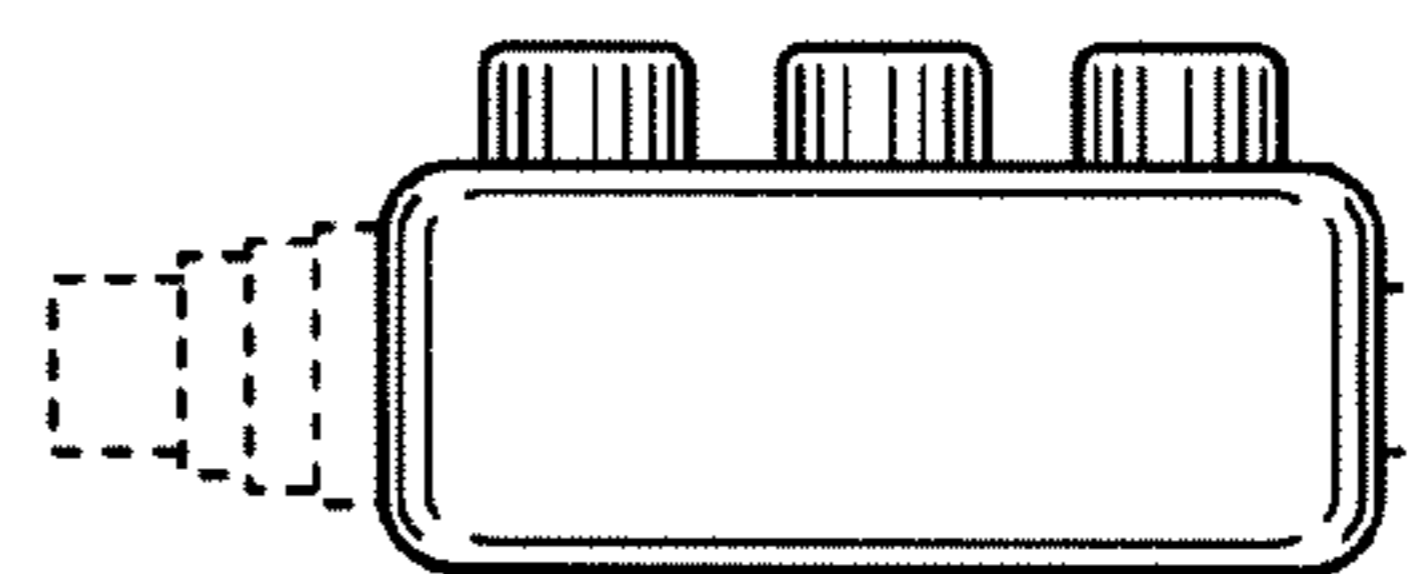

FIG. 104

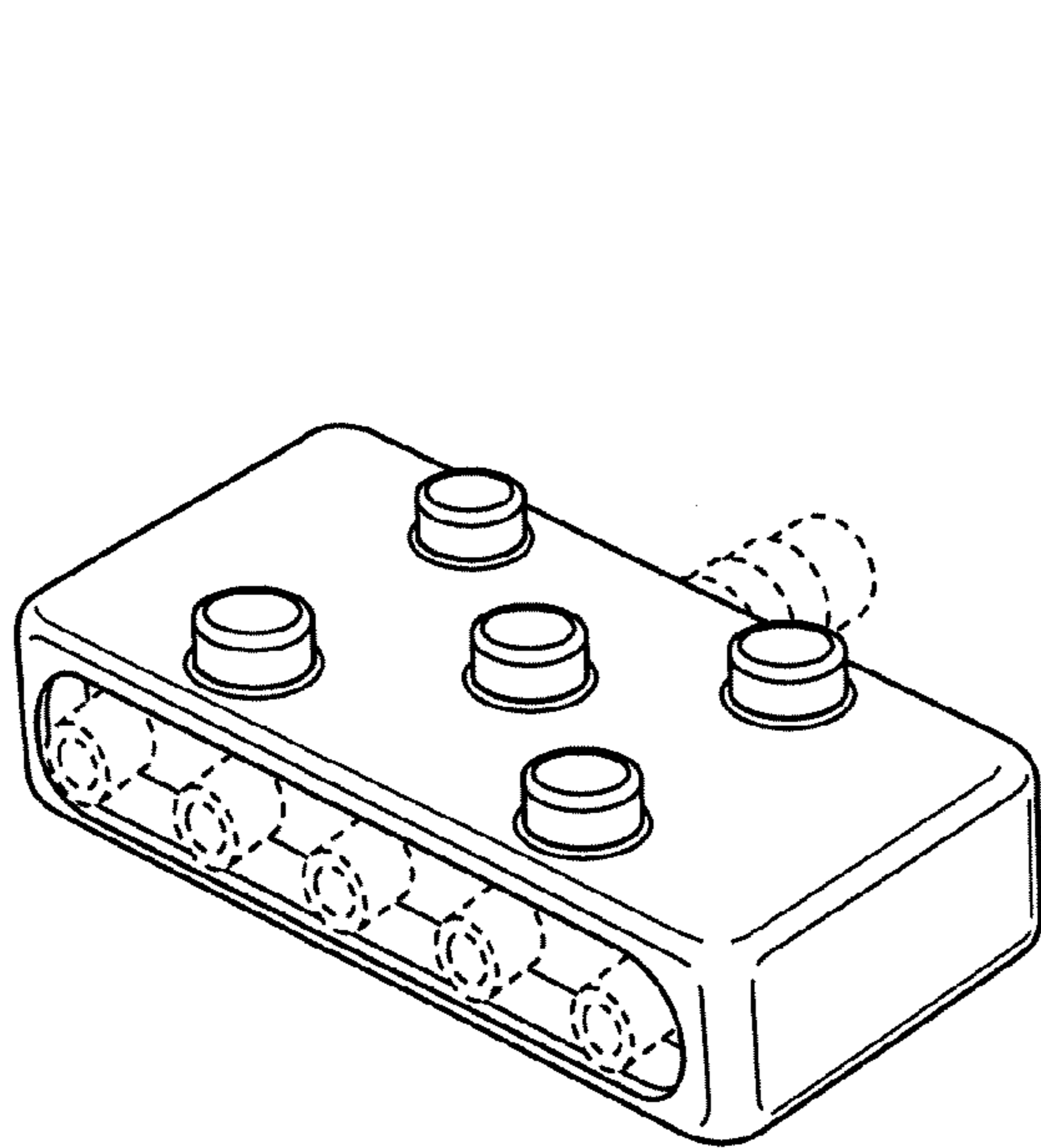

FIG. 105

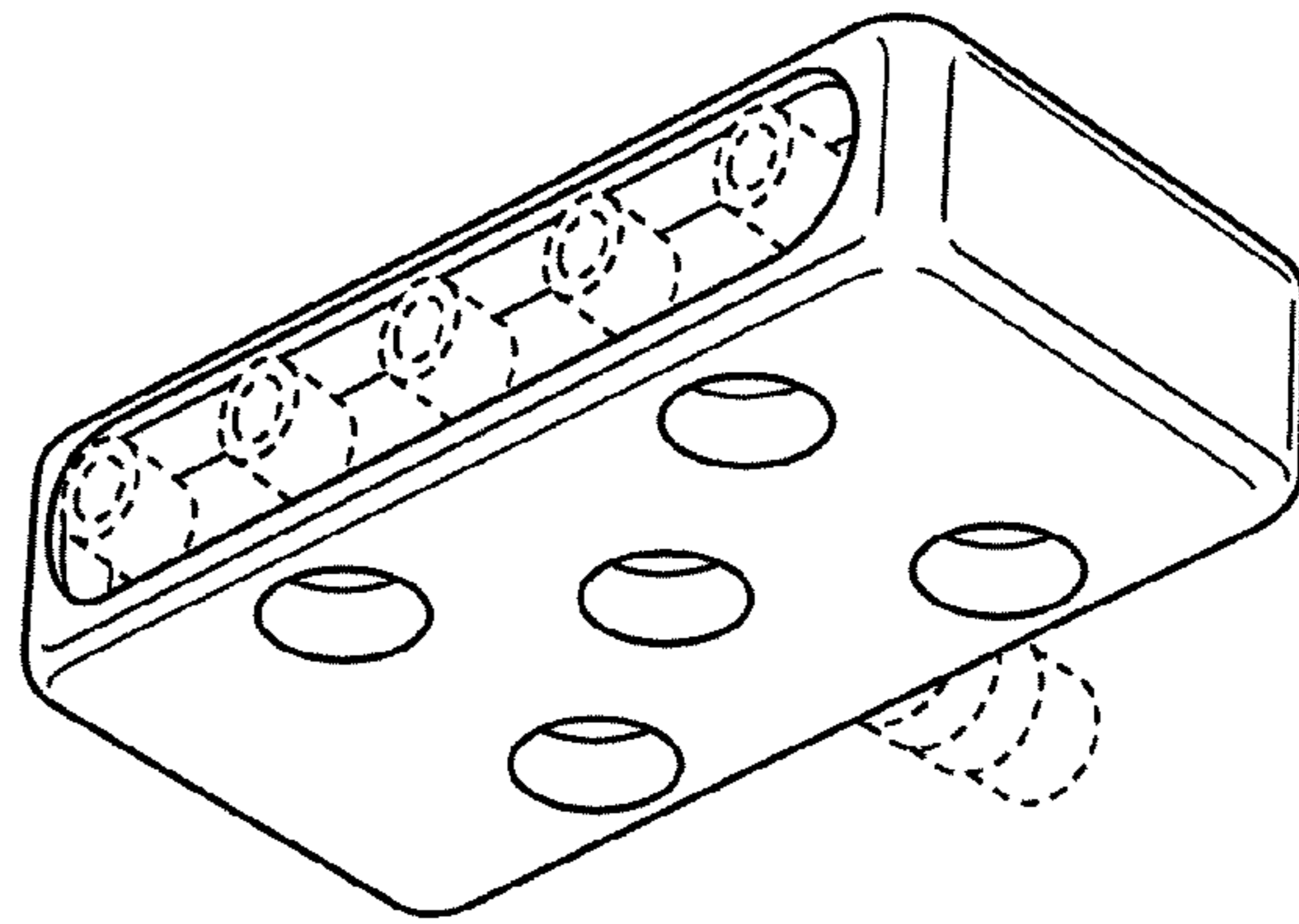

FIG. 106

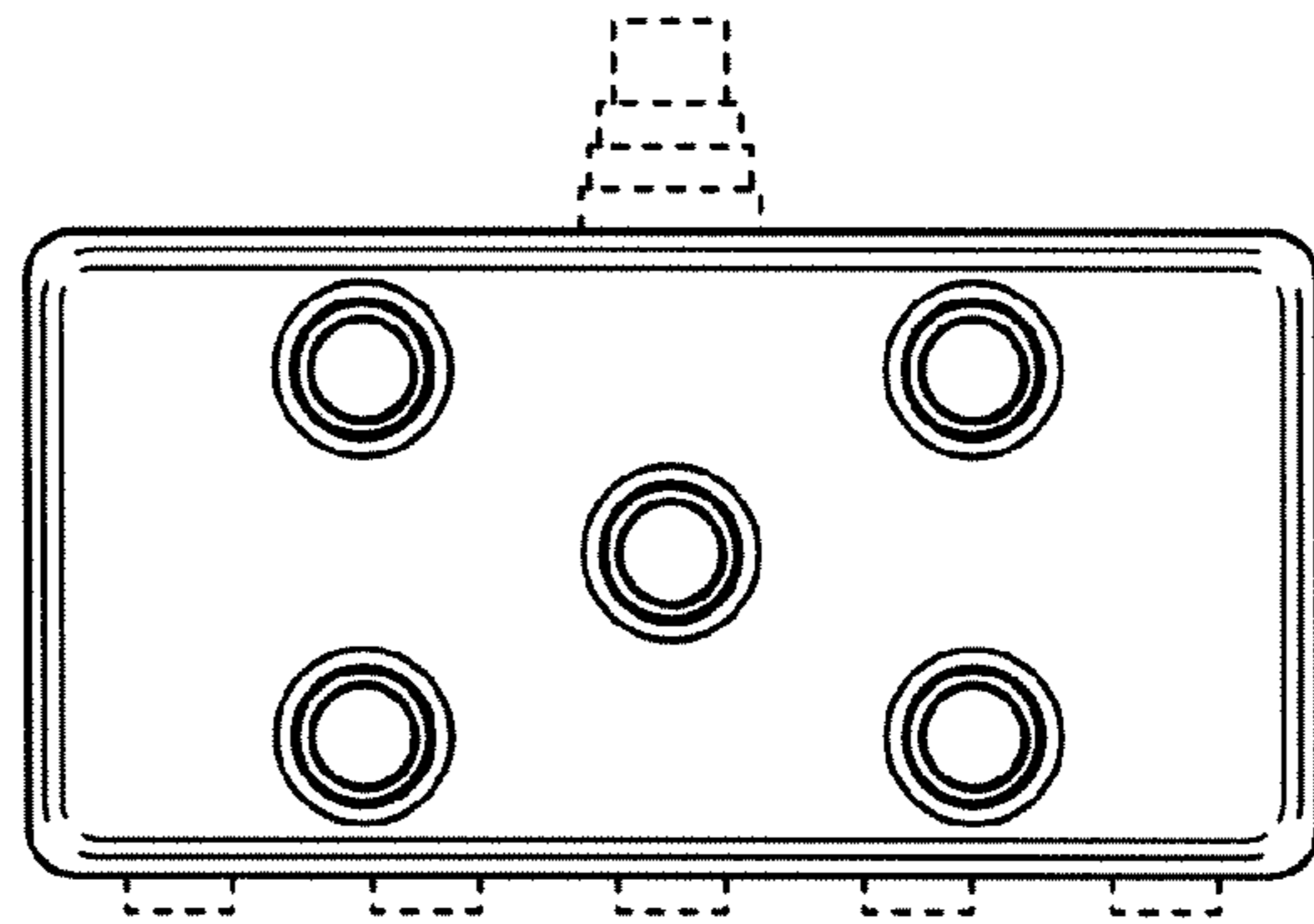

FIG. 107

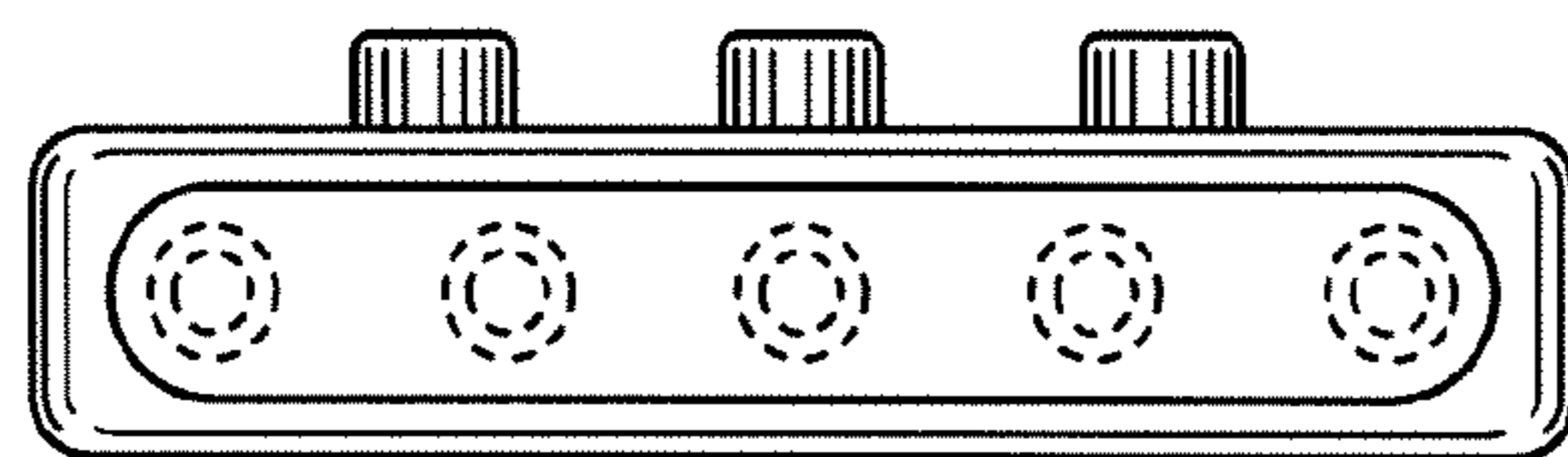

FIG. 108

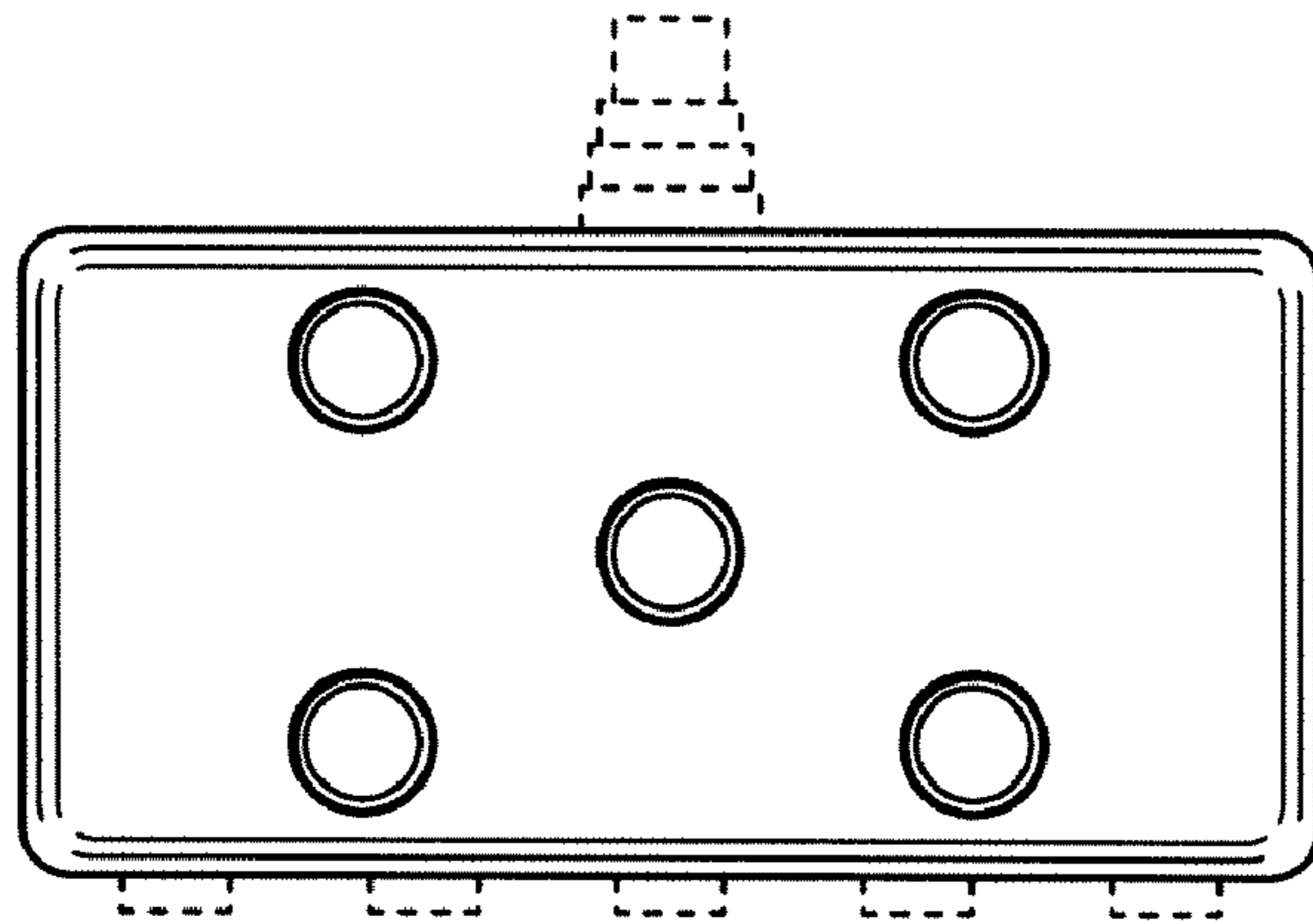

FIG. 109

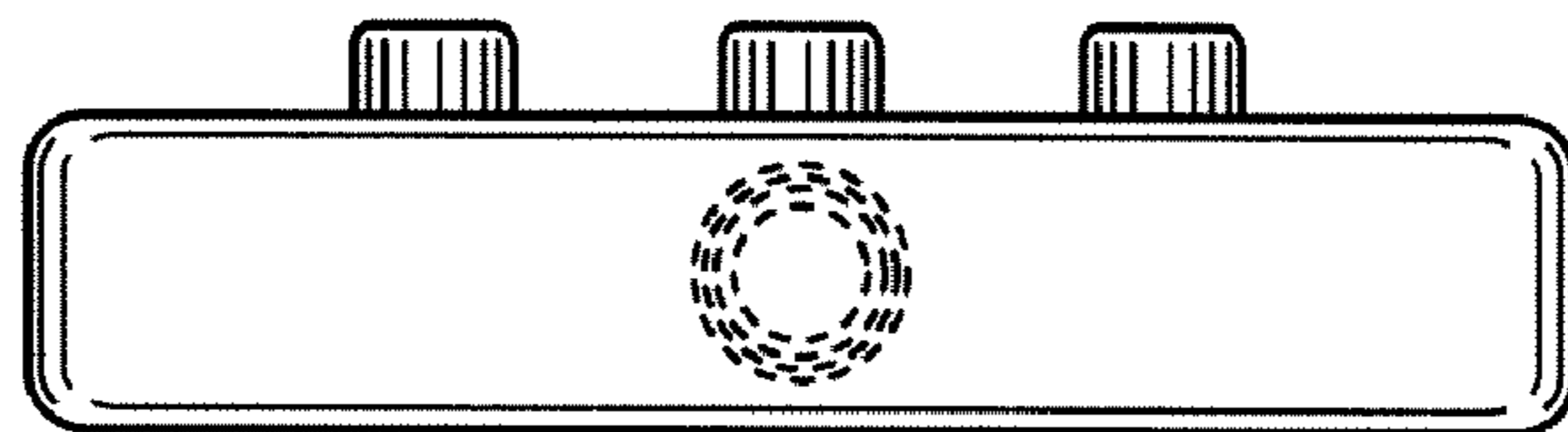

FIG. 110

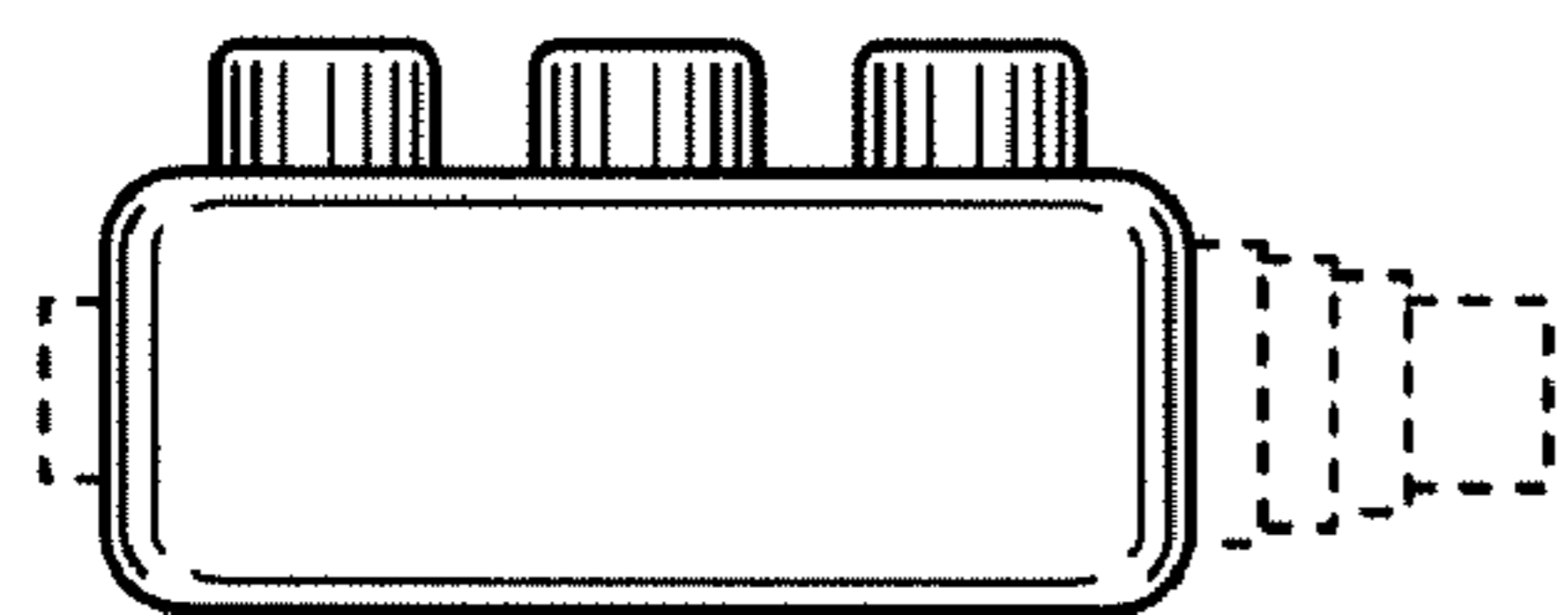

FIG. 111

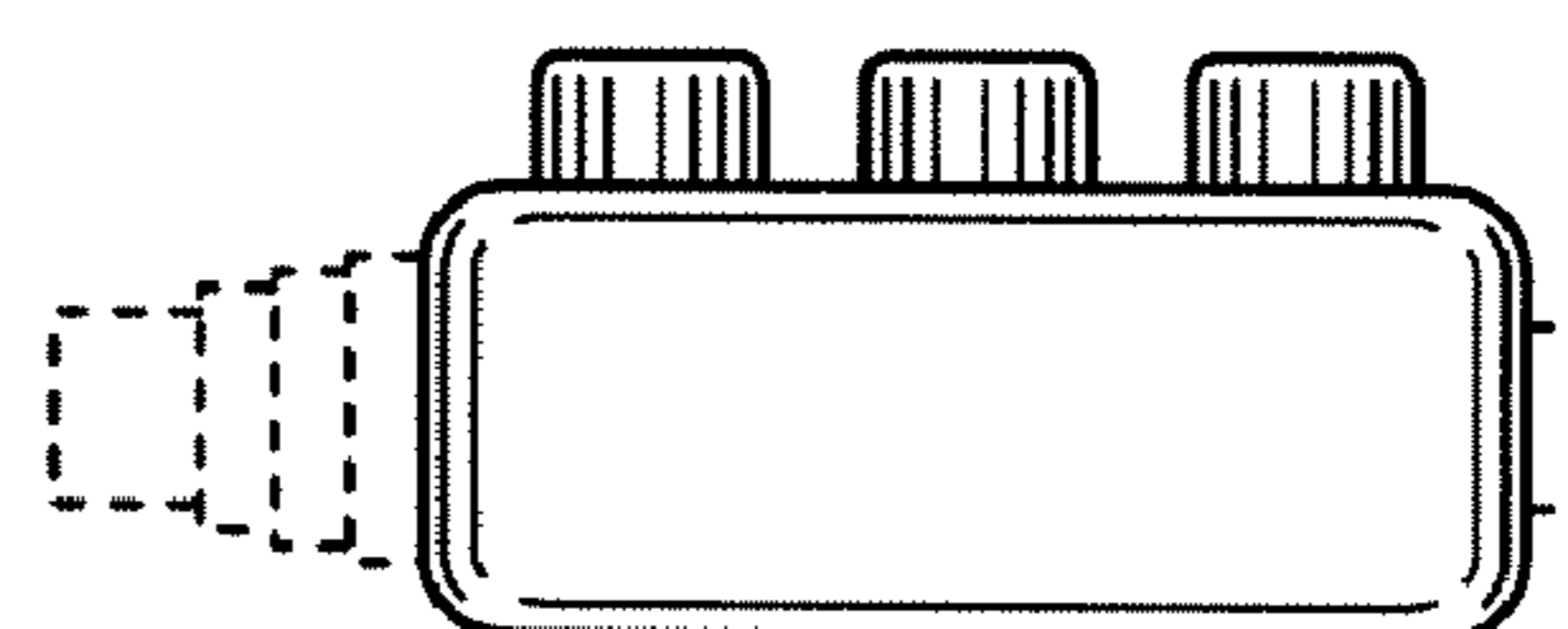

FIG. 112

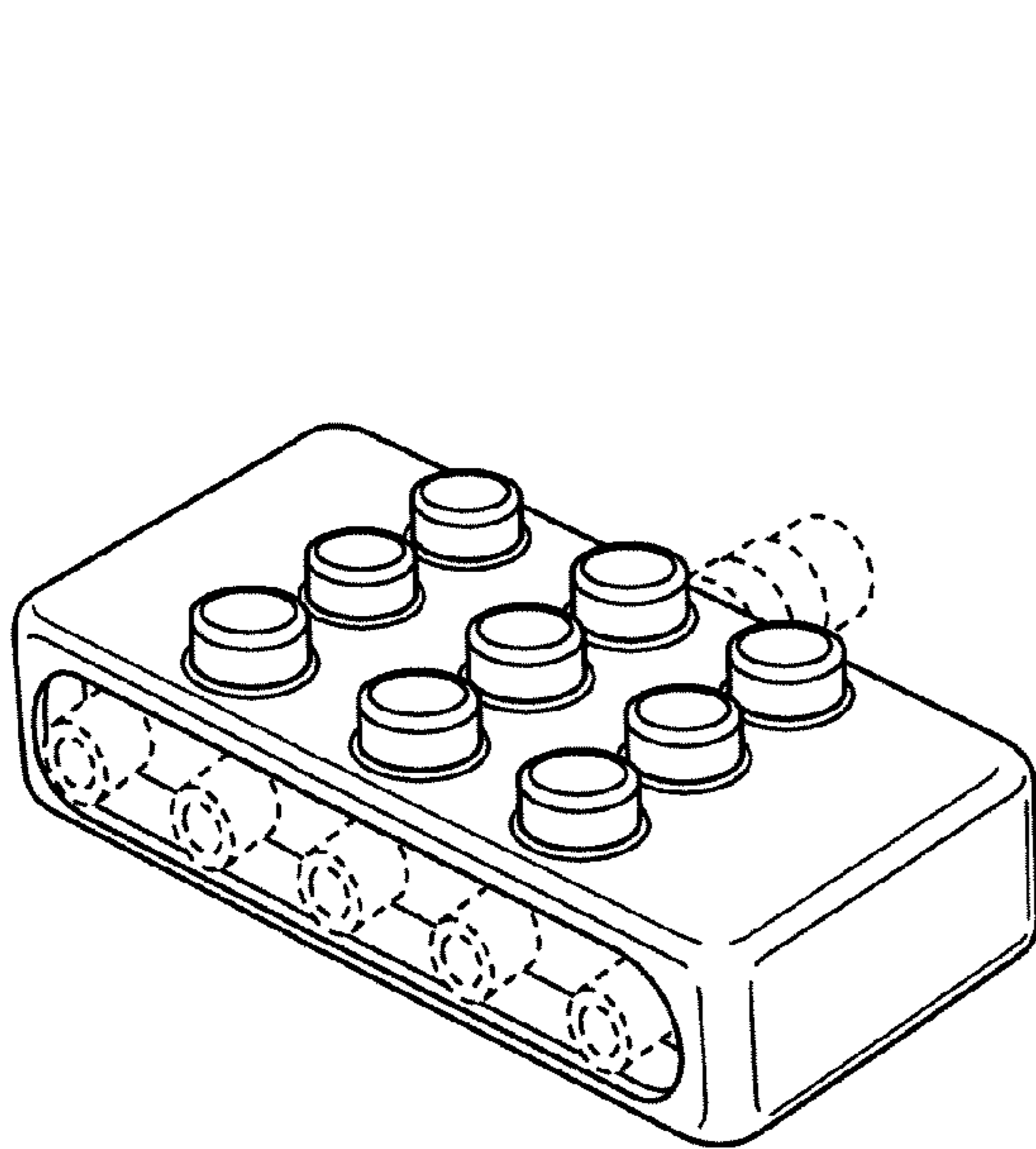

FIG. 113

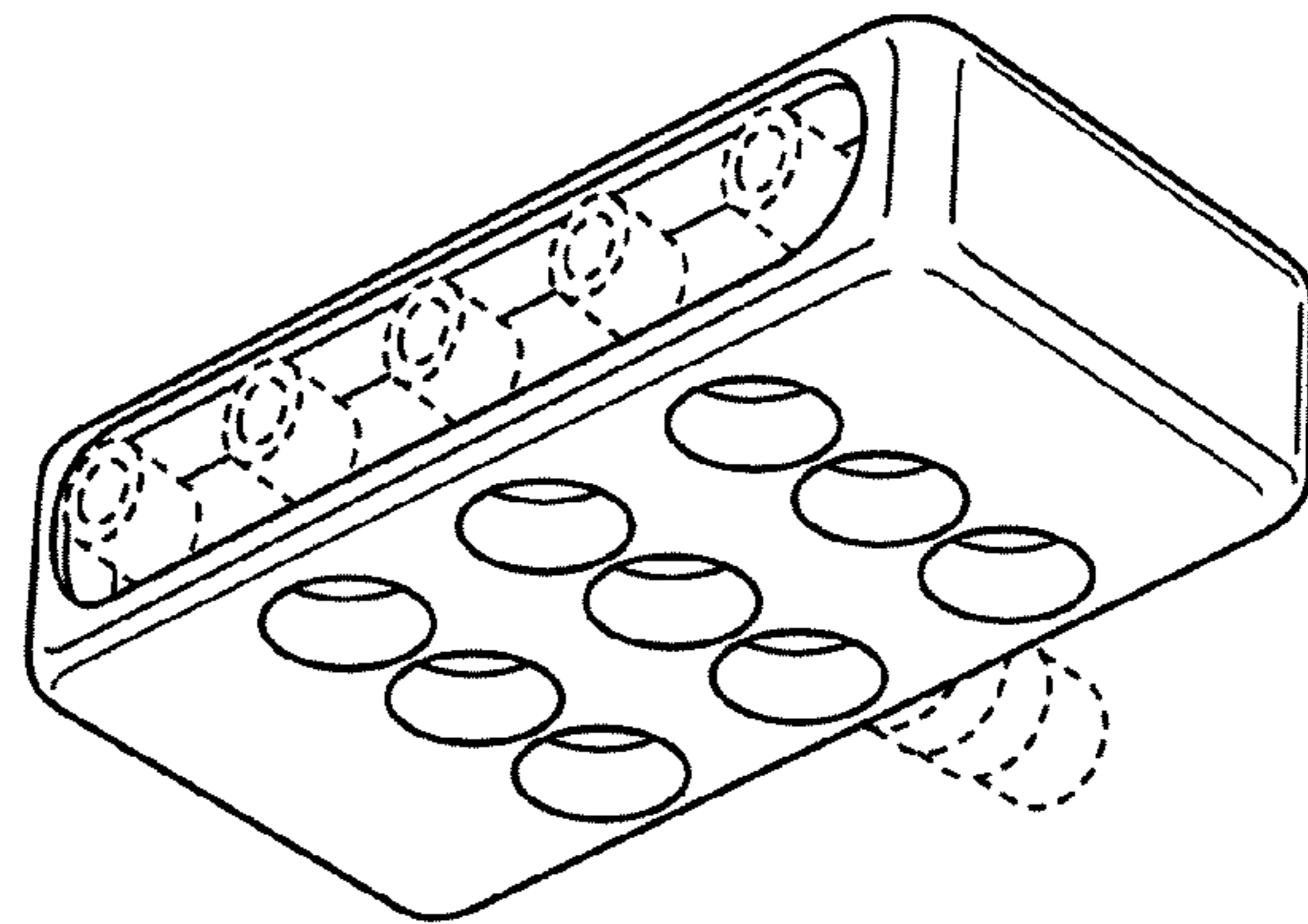

FIG. 114

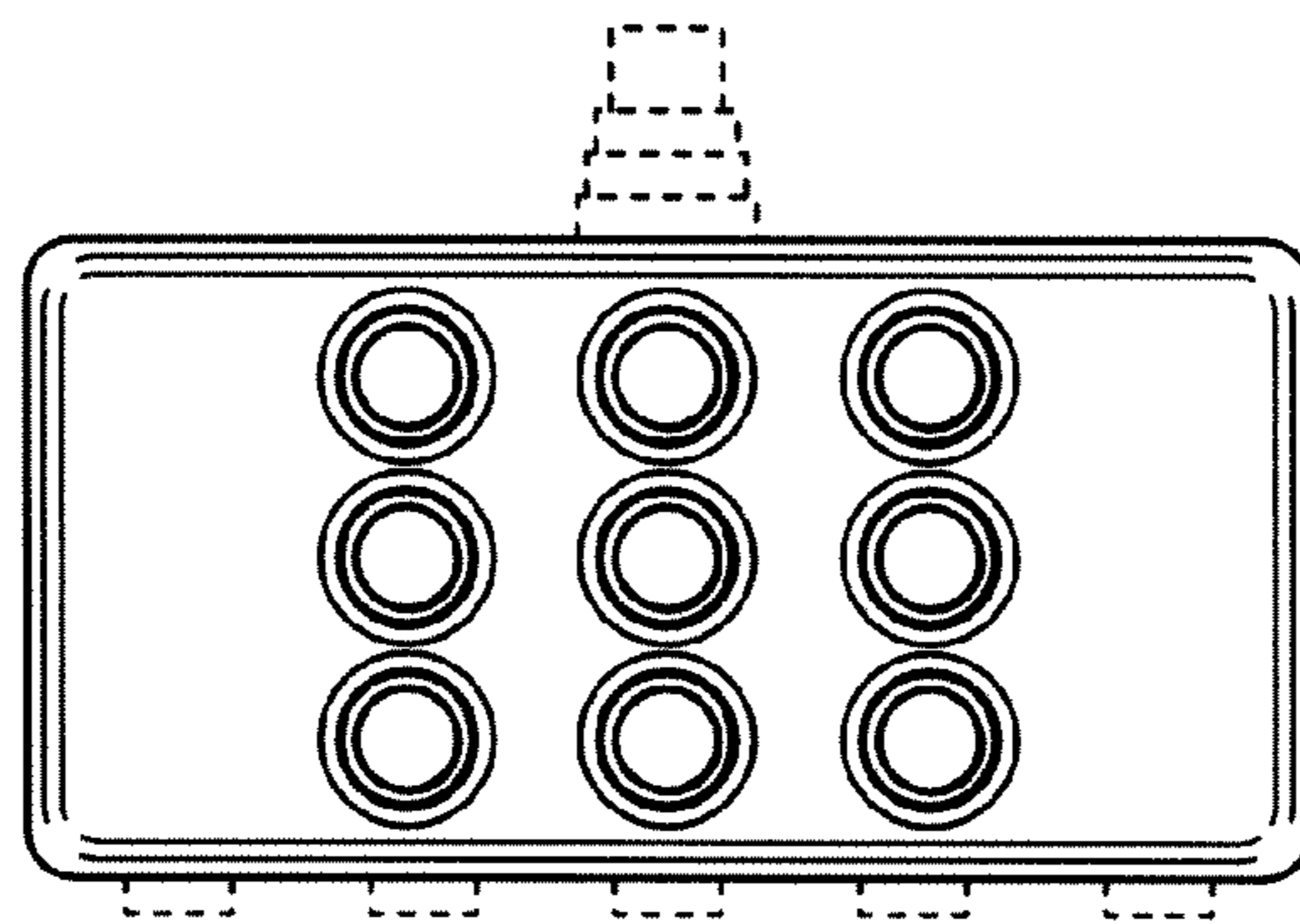

FIG. 115

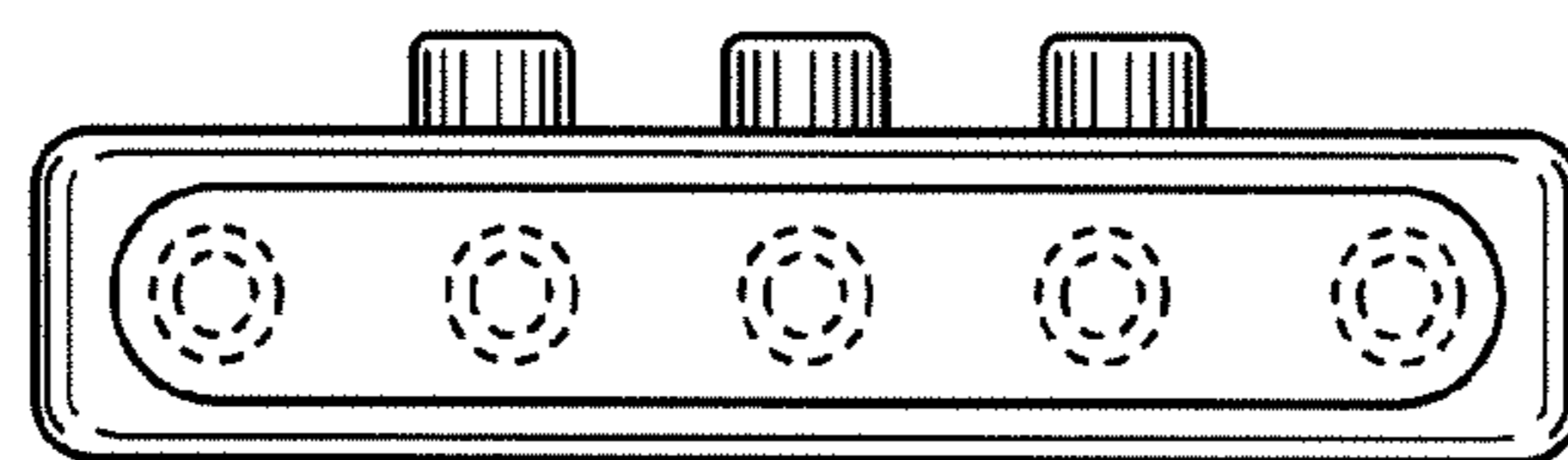

FIG. 116

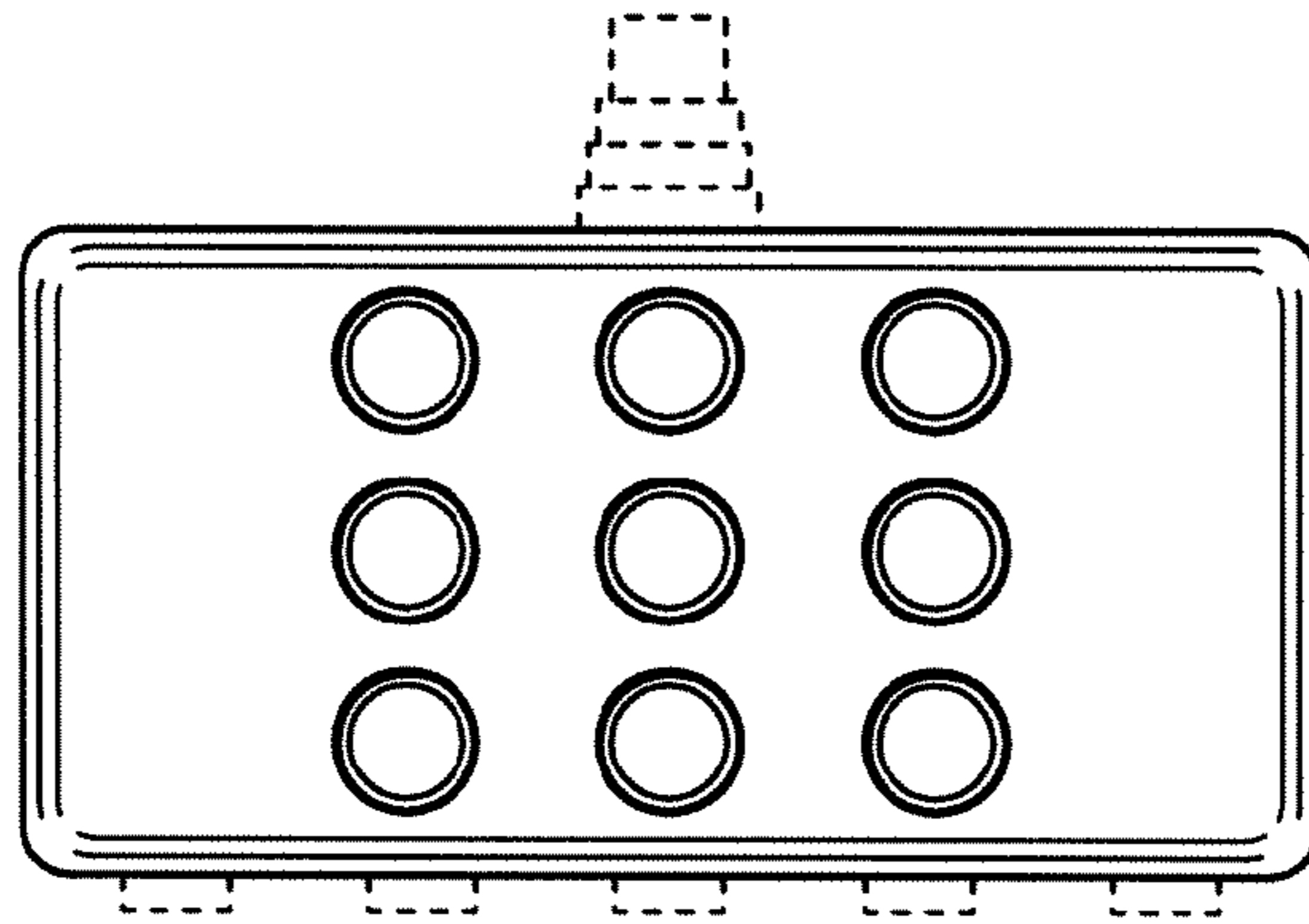

FIG. 117

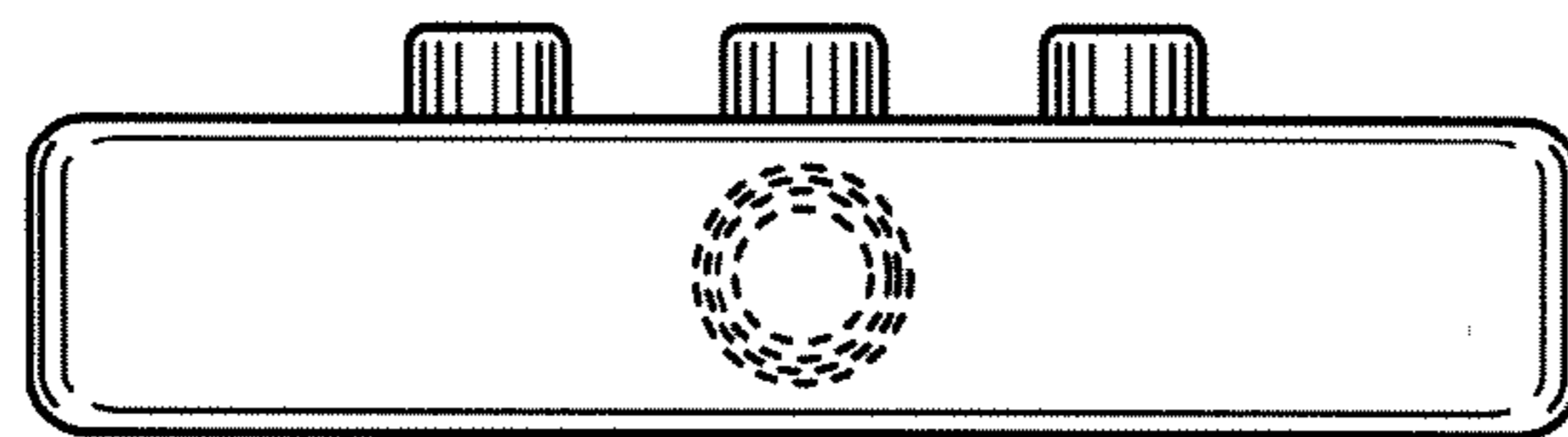

FIG. 118

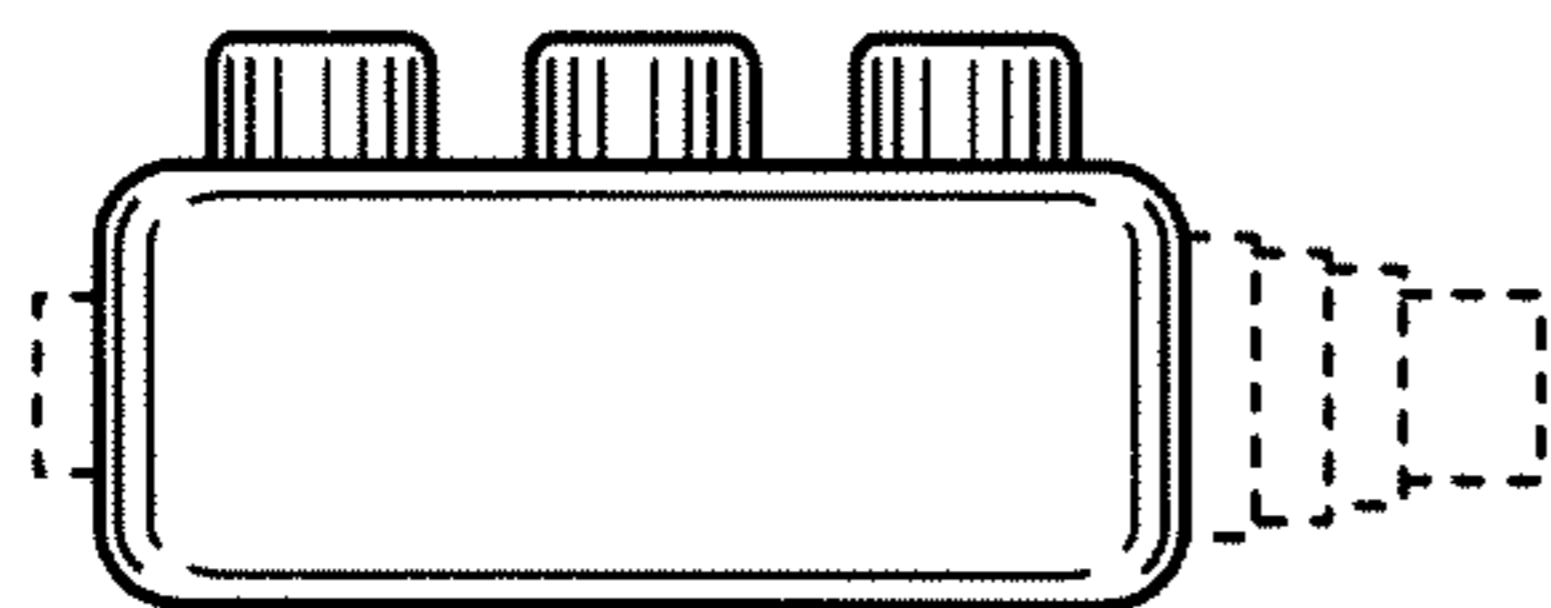

FIG. 119

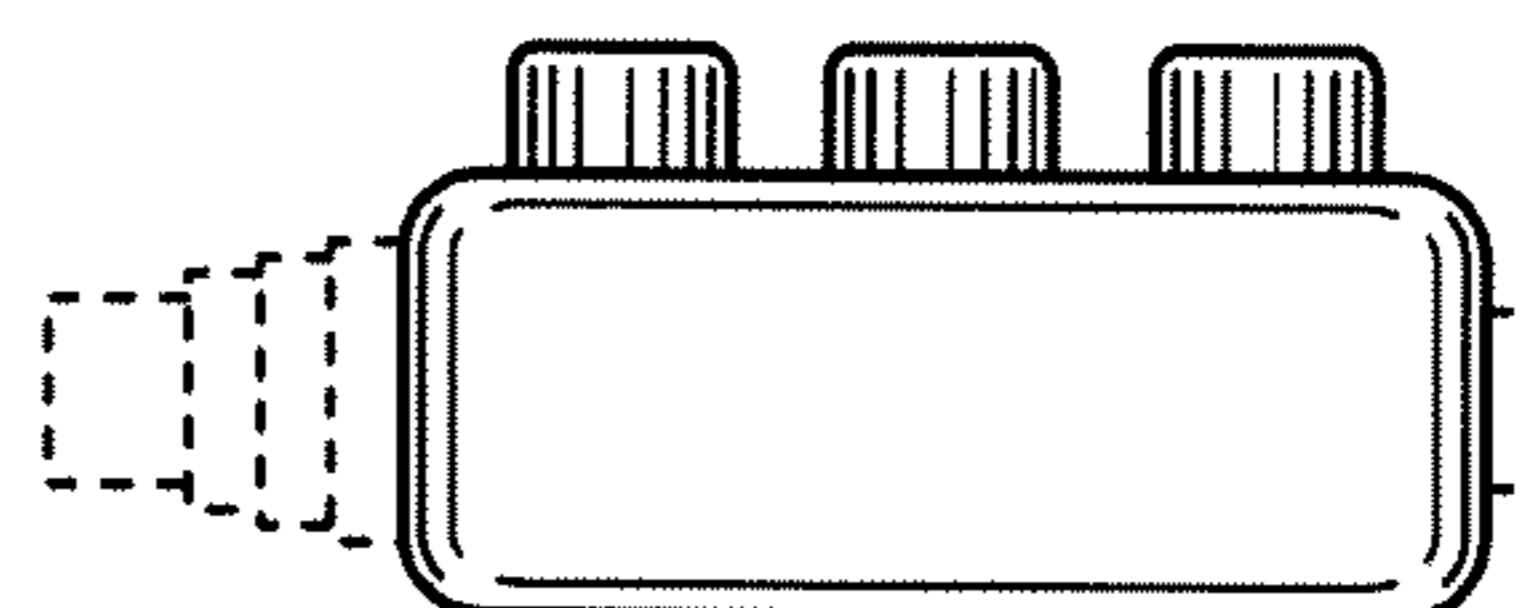

FIG. 120