



US00D574651S

(12) **United States Design Patent**
Wonderley et al.

(10) **Patent No.:** **US D574,651 S**

(45) **Date of Patent:** **** Aug. 12, 2008**

(54) **WALL HANGER FOR A RAZOR**

(75) Inventors: **Jeffrey W. Wonderley**, Fort Defiance, VA (US); **Linh Li Dooc**, Blacksburg, VA (US)

(73) Assignee: **American Safety Razor**, Verona, VA (US)

(**) Term: **14 Years**

(21) Appl. No.: **29/295,240**

(22) Filed: **Sep. 24, 2007**

(51) **LOC (8) Cl.** **28-03**

(52) **U.S. Cl.** **D6/526**

(58) **Field of Classification Search** D6/524,
D6/256, 540, 553, 567; D8/373; 211/13.1,
211/70.6, 87.01, 89.01; 248/200, 205.5,
248/309.1, 314

See application file for complete search history.

(56) **References Cited**

U.S. PATENT DOCUMENTS

D145,084 S	6/1946	Hutt et al.	
2,470,825 A	5/1949	Long	
D230,675 S	3/1974	Wilkins	
D238,529 S	1/1976	Muller	
D251,970 S	5/1979	Fujita	
D283,076 S *	3/1986	States, Jr.	D6/526
4,773,158 A	9/1988	Kertzman	
D370,375 S *	6/1996	Murgida et al.	D6/526
D387,897 S	12/1997	Yorke et al.	
D423,845 S	5/2000	Coffin et al.	
D464,222 S *	10/2002	Coffin et al.	D6/526
7,040,024 B2 *	5/2006	Lukan et al.	D6/526
D533,740 S *	12/2006	Dombrowski et al.	D6/526
D534,901 S	1/2007	Ma et al.	
D547,582 S *	7/2007	Lukan	D6/526
2007/0017833 A1	1/2007	Lukan	

FOREIGN PATENT DOCUMENTS

WO WO 2007/008622 A1 1/2007

* cited by examiner

Primary Examiner—Brian N Vinson

(74) *Attorney, Agent, or Firm*—McDermott Will & Emery LLP

(57) **CLAIM**

The ornamental design for a wall hanger for a razor, as shown and described.

DESCRIPTION

FIG. 1 is a front perspective view of the wall hanger for a razor, showing the new design;

FIG. 2 is a front view of the wall hanger for a razor;

FIG. 3 is a rear view of the wall hanger for a razor;

FIG. 4 is a side view of the wall hanger for a razor;

FIG. 5 is another side view of the wall hanger for a razor;

FIG. 6 is a top view of the wall hanger for a razor;

FIG. 7 is a bottom view of the wall hanger for a razor;

FIG. 8 is a front perspective view of the wall hanger for a razor with a razor in it;

FIG. 9 is a front view of the wall hanger for a razor with a razor in it;

FIG. 10 is a rear view of the wall hanger for a razor with a razor in it;

FIG. 11 is a side view of the wall hanger for a razor with a razor in it;

FIG. 12 is another side view of the wall hanger for a razor with a razor in it;

FIG. 13 is a top view of the wall hanger for a razor with a razor in it; and,

FIG. 14 is a bottom view of the wall hanger for a razor with a razor in it.

The broken lines showing various elements of the wall hanger for a razor and the razor in the wall hanger for a razor, are included for the purpose of illustrating non-claimed subject matter and forms no part of the claimed design.

1 Claim, 9 Drawing Sheets

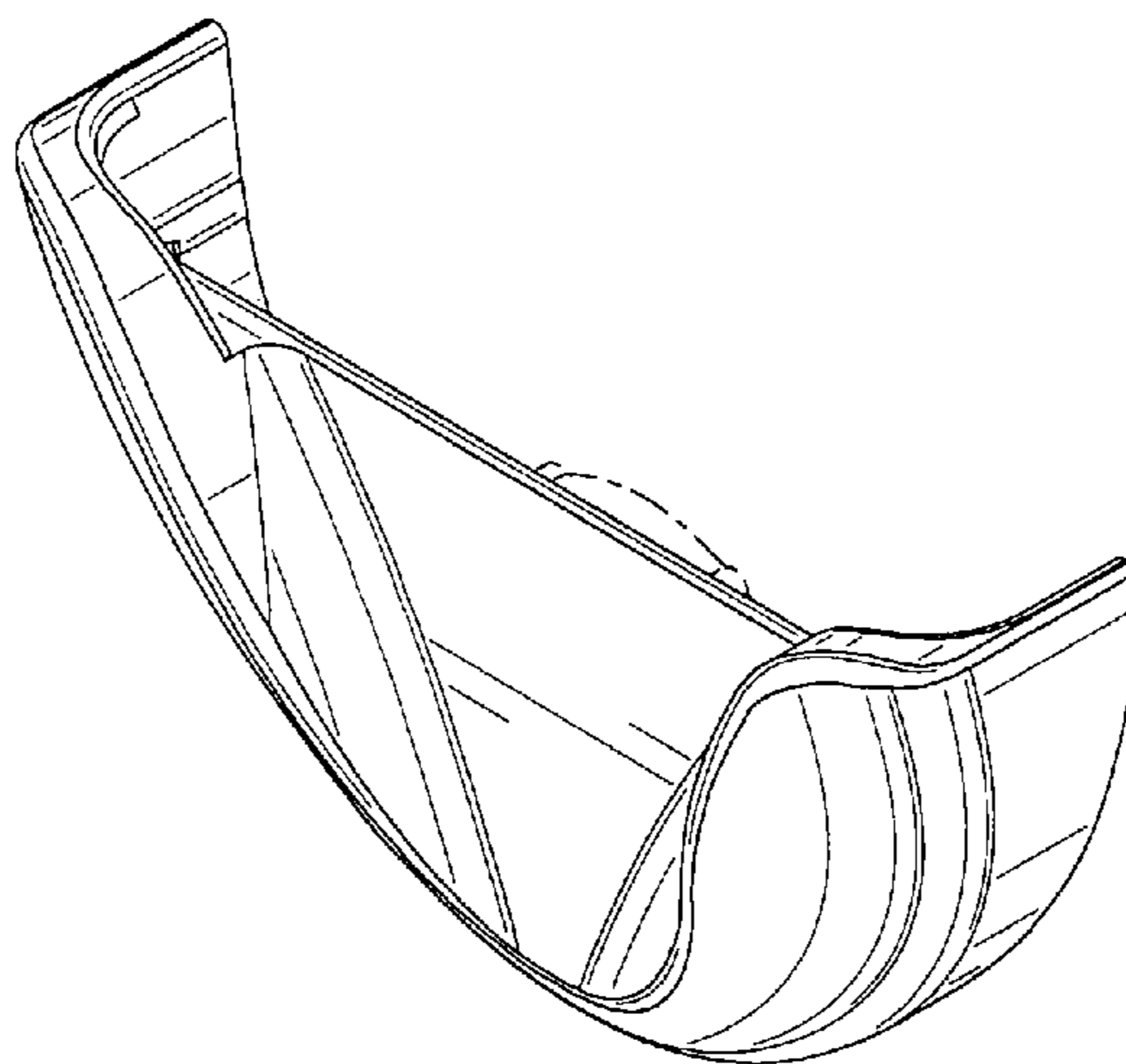

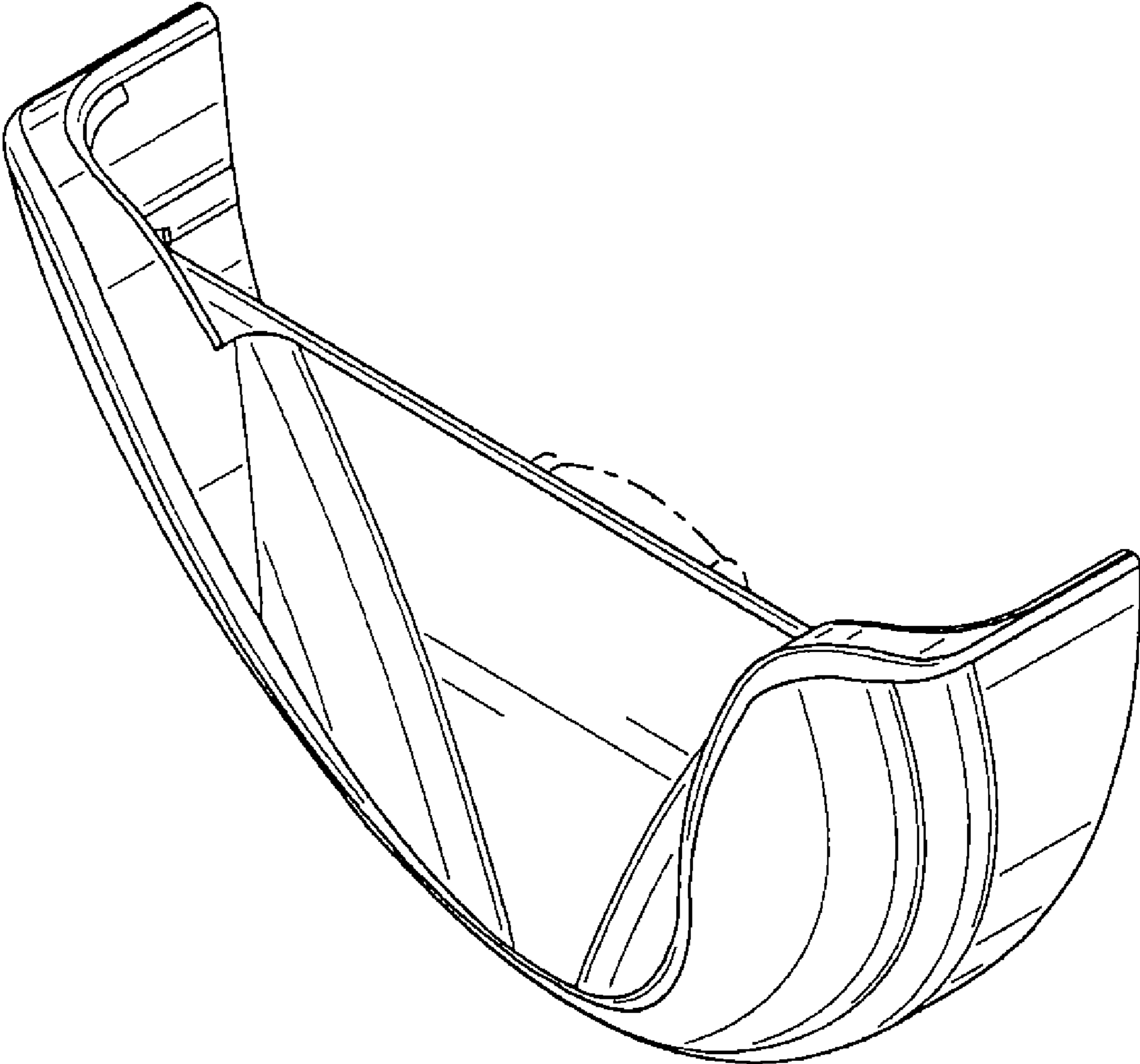

FIG. 1

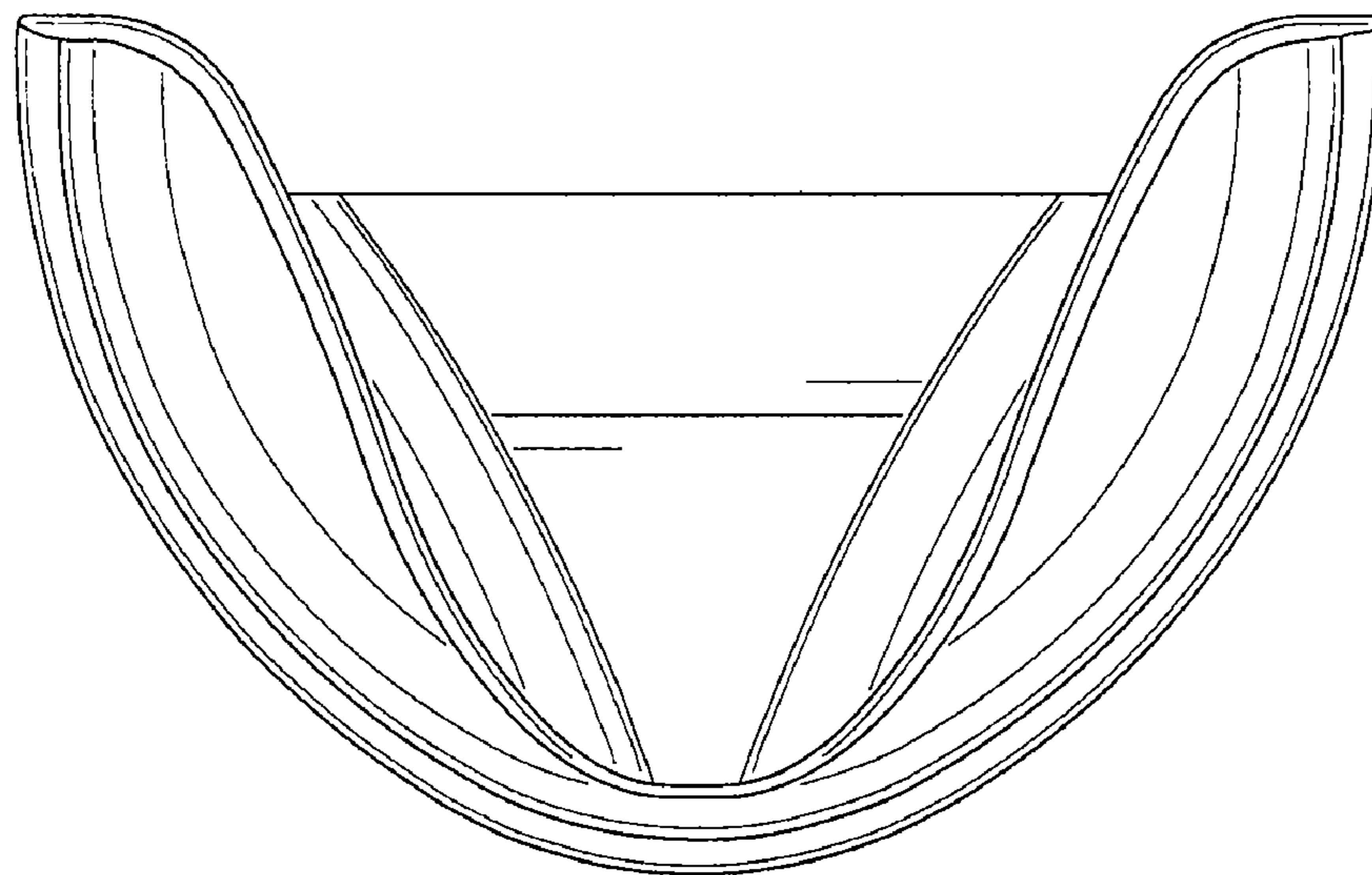

FIG. 2

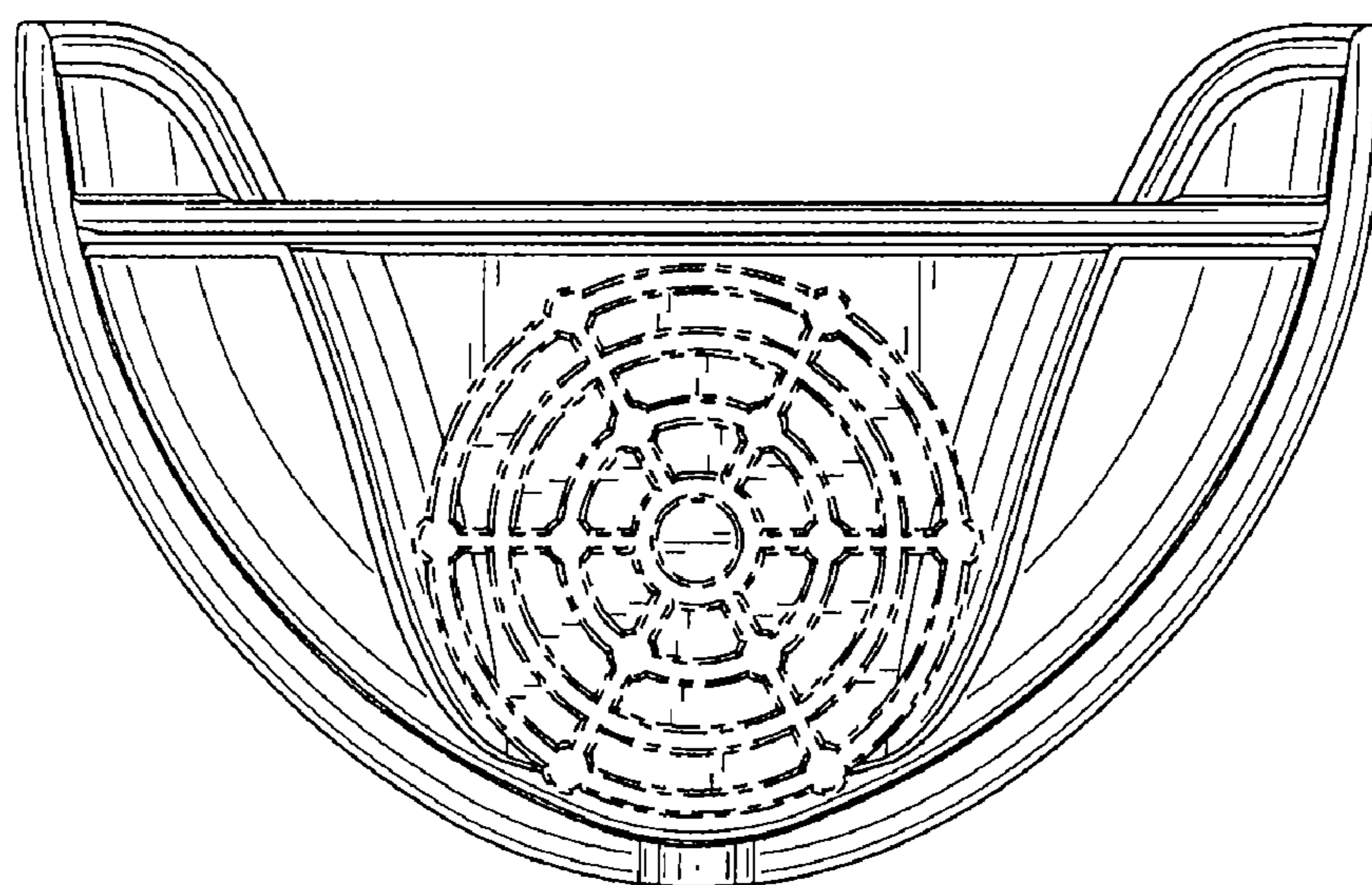

FIG. 3

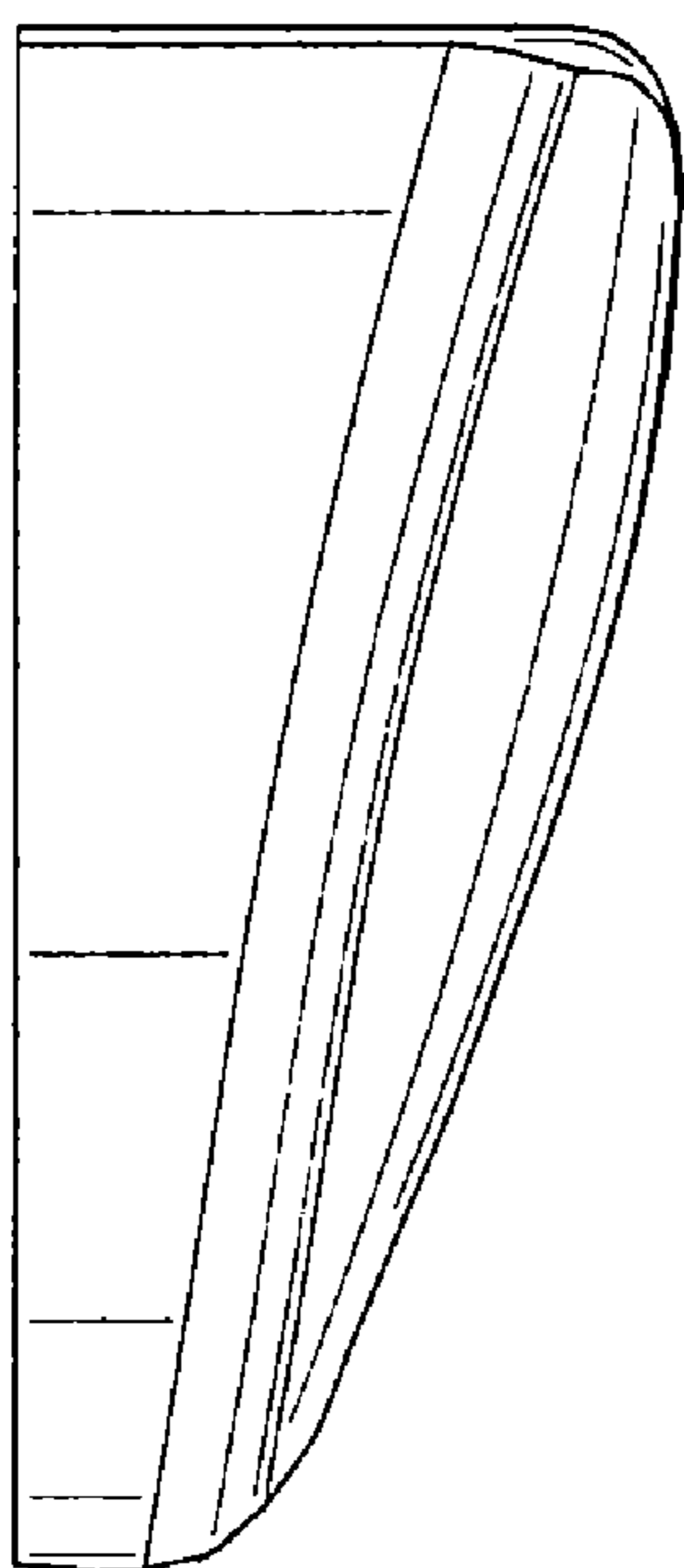

FIG. 4

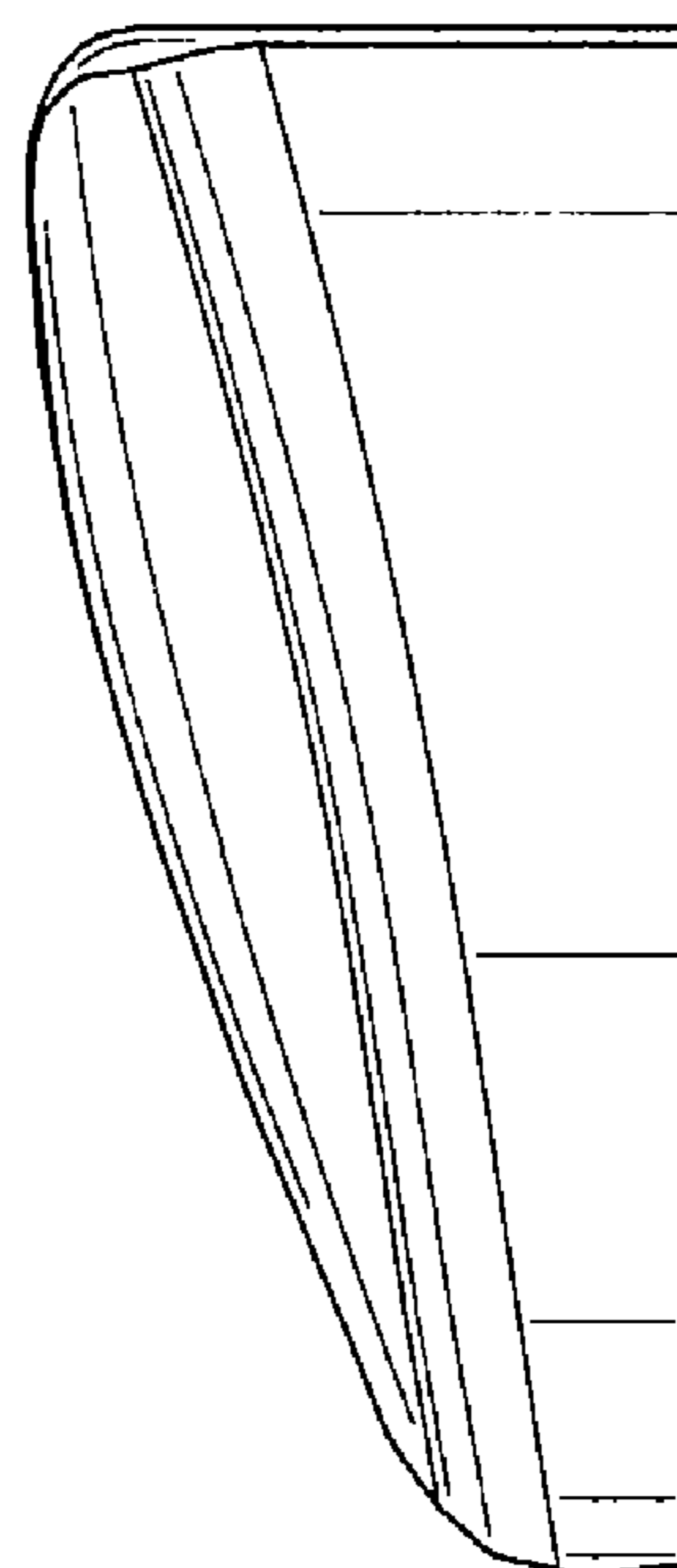

FIG. 5

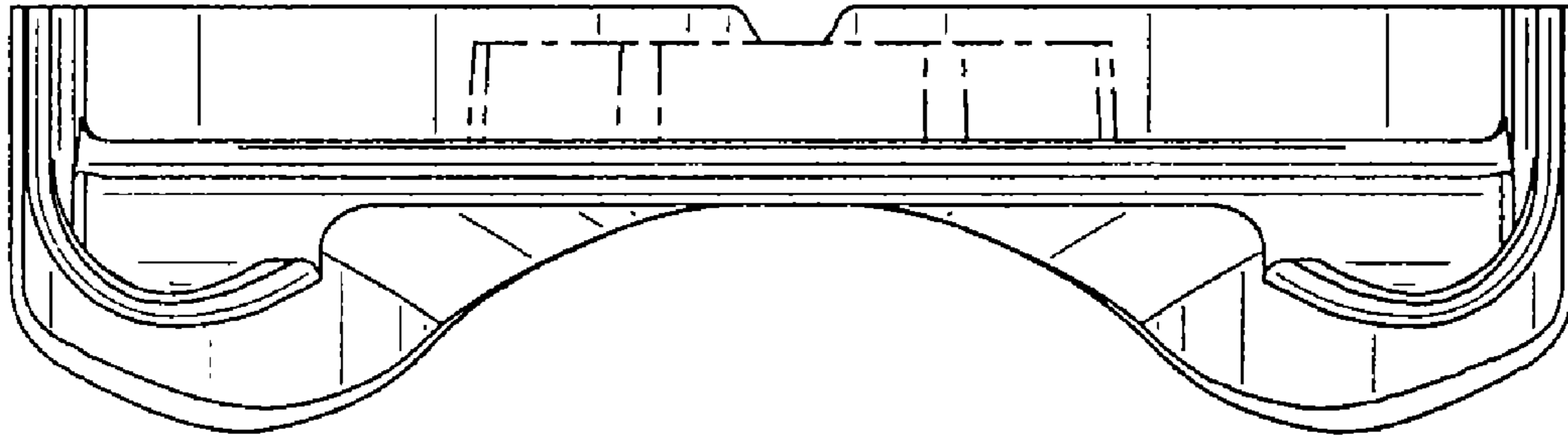

FIG. 6

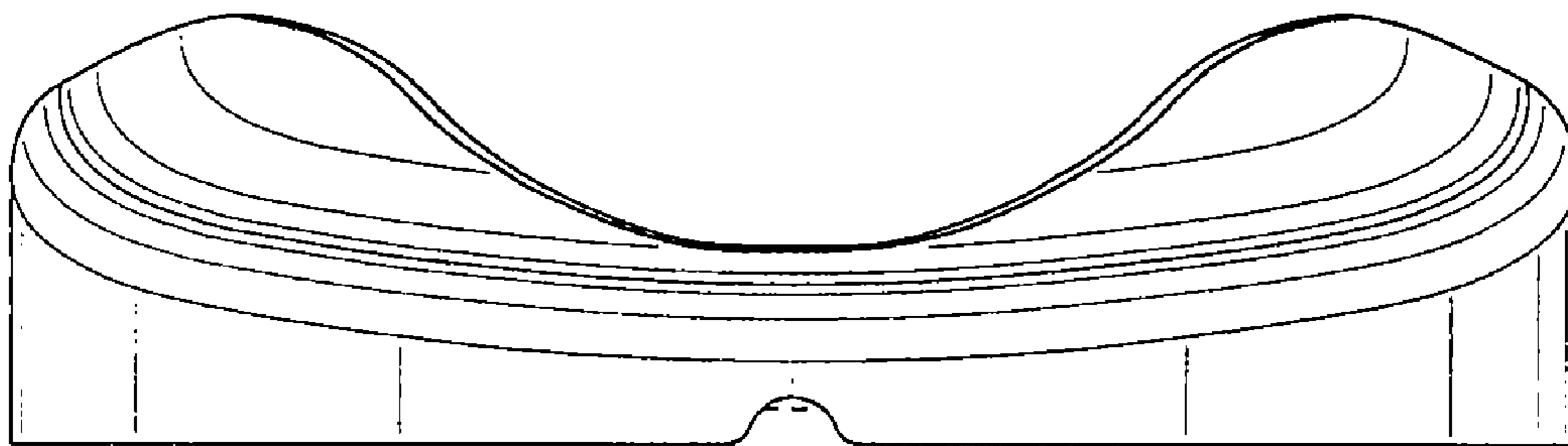

FIG. 7

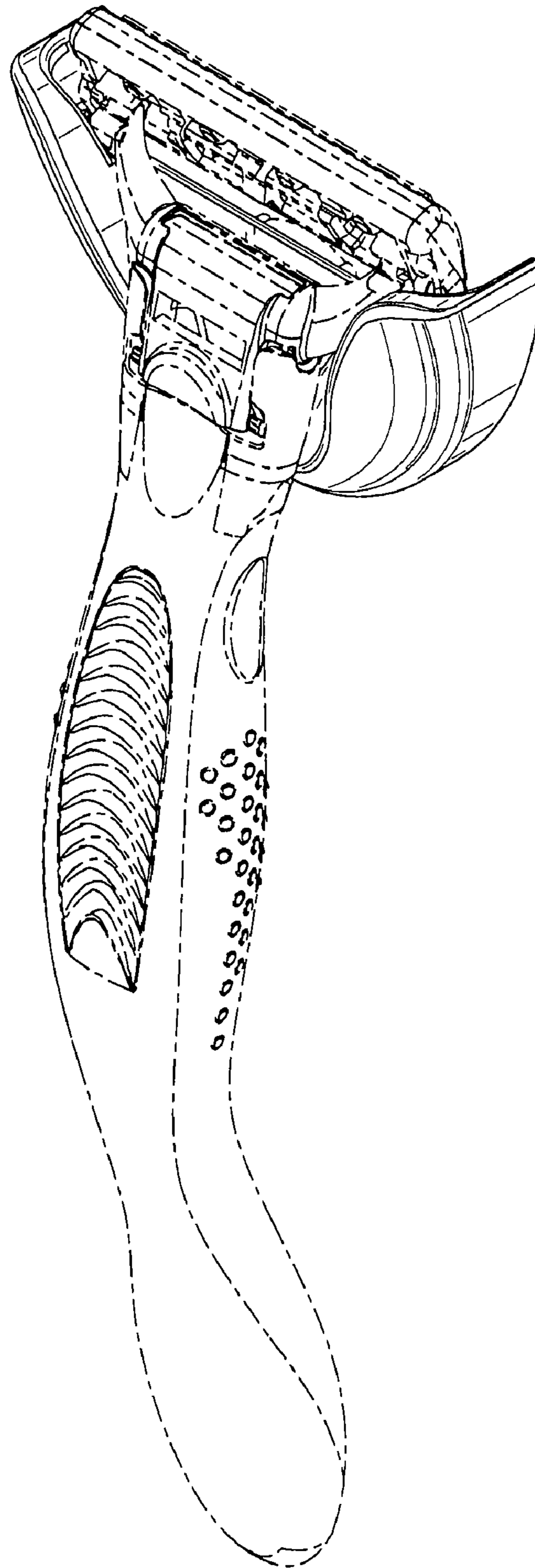

FIG. 8

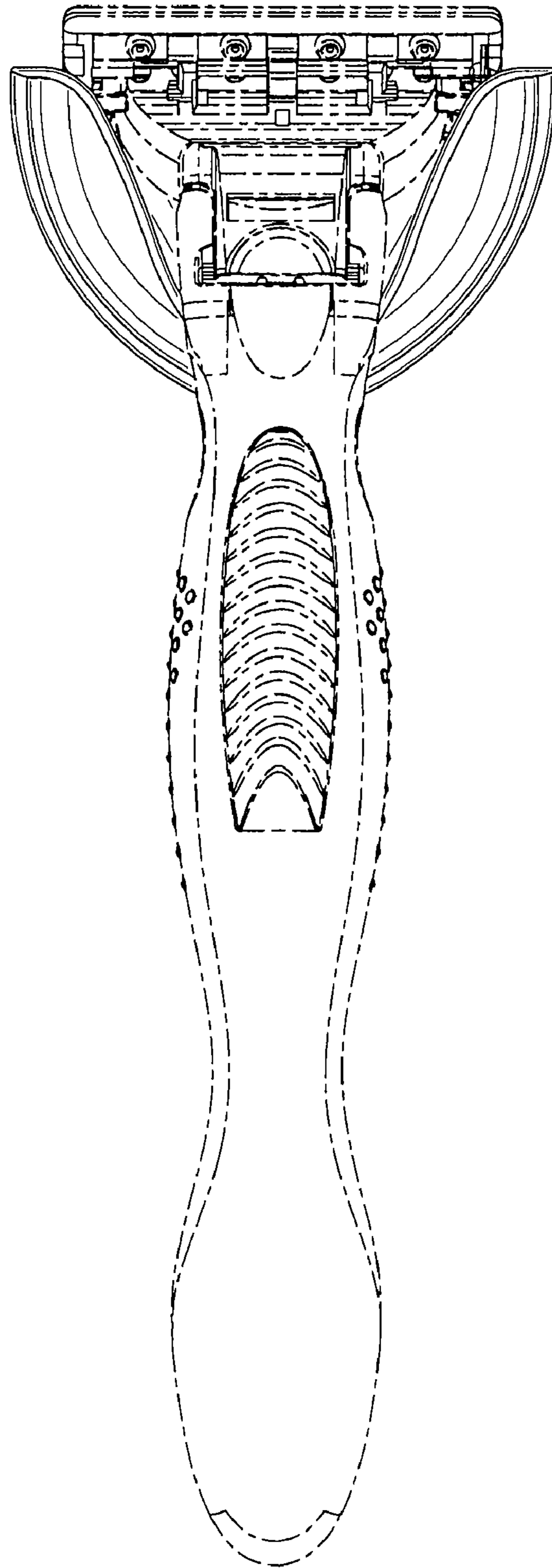

FIG. 9

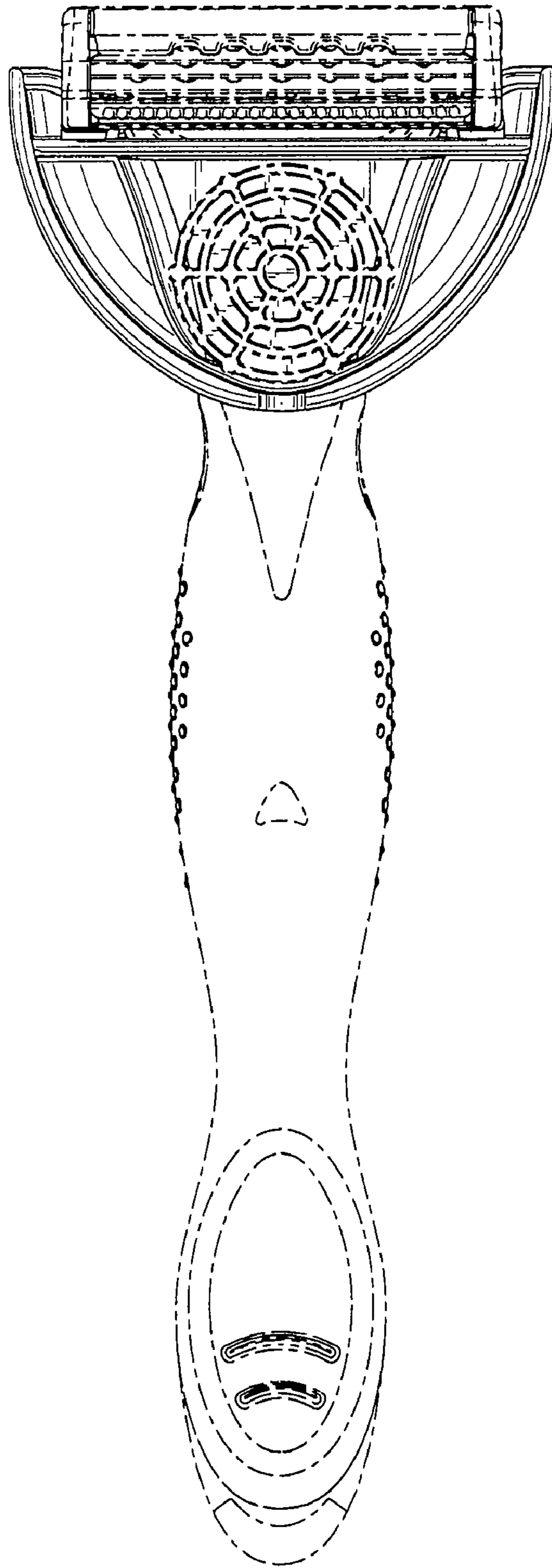

FIG. 10

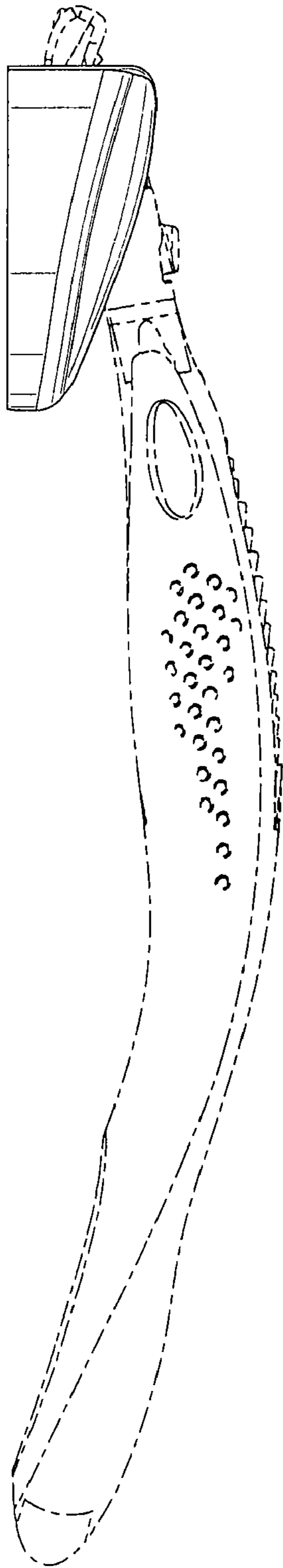

FIG. 11

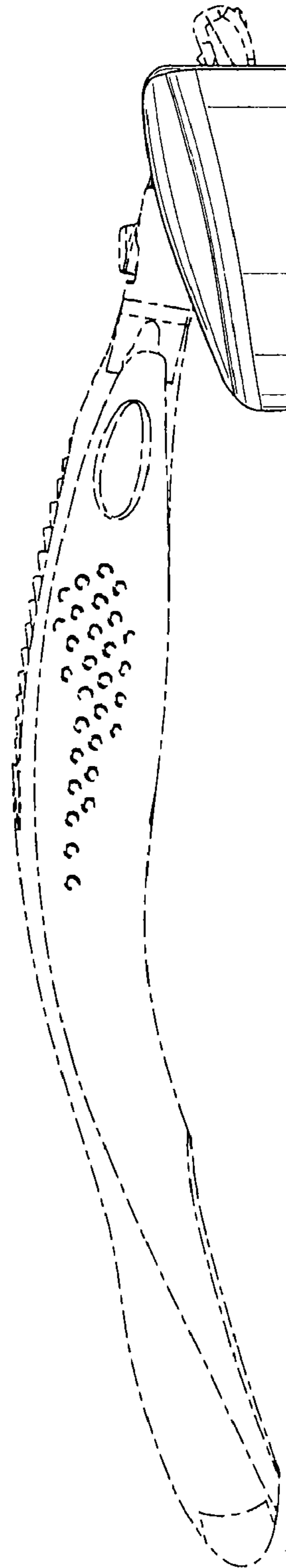

FIG. 12

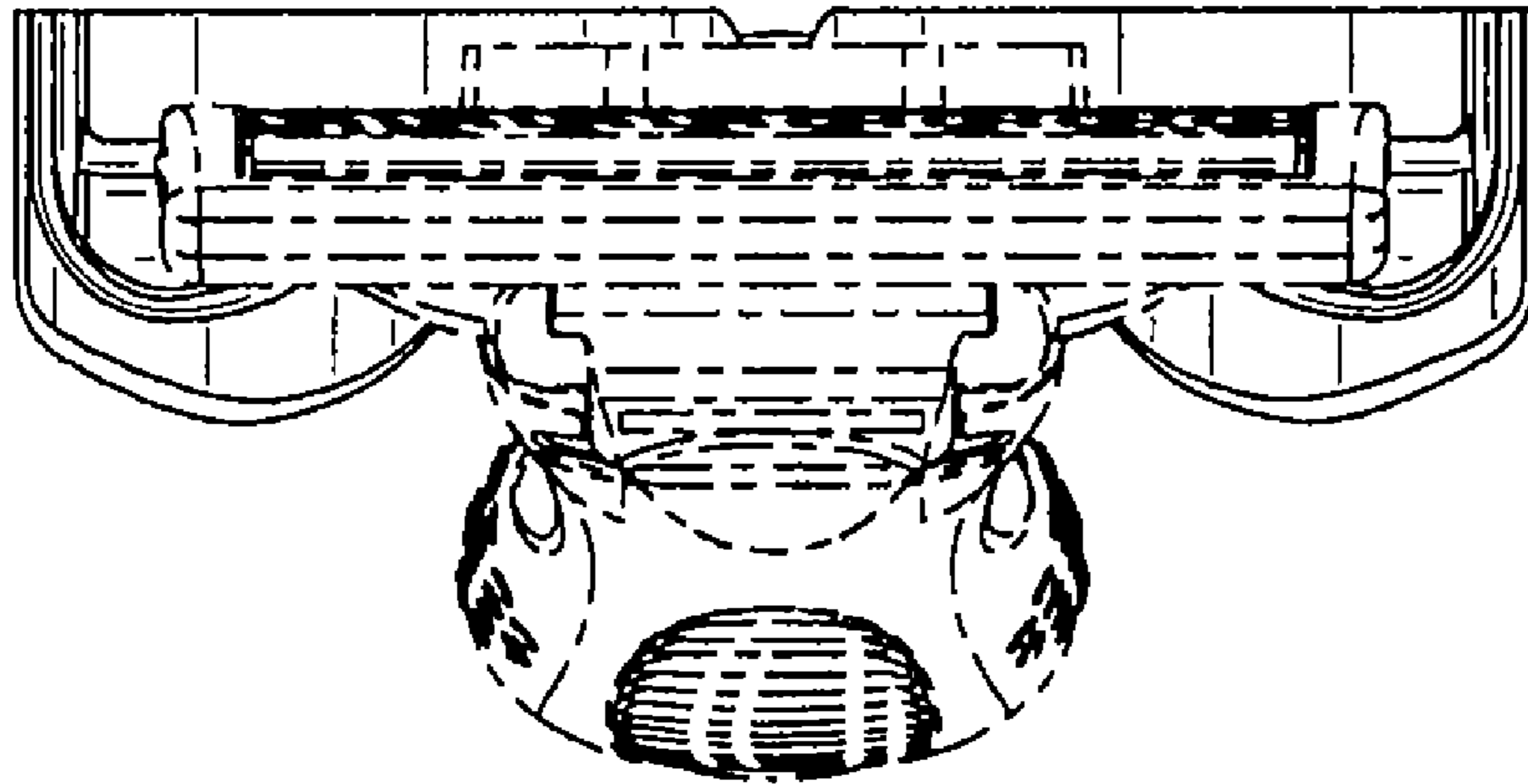

FIG. 13

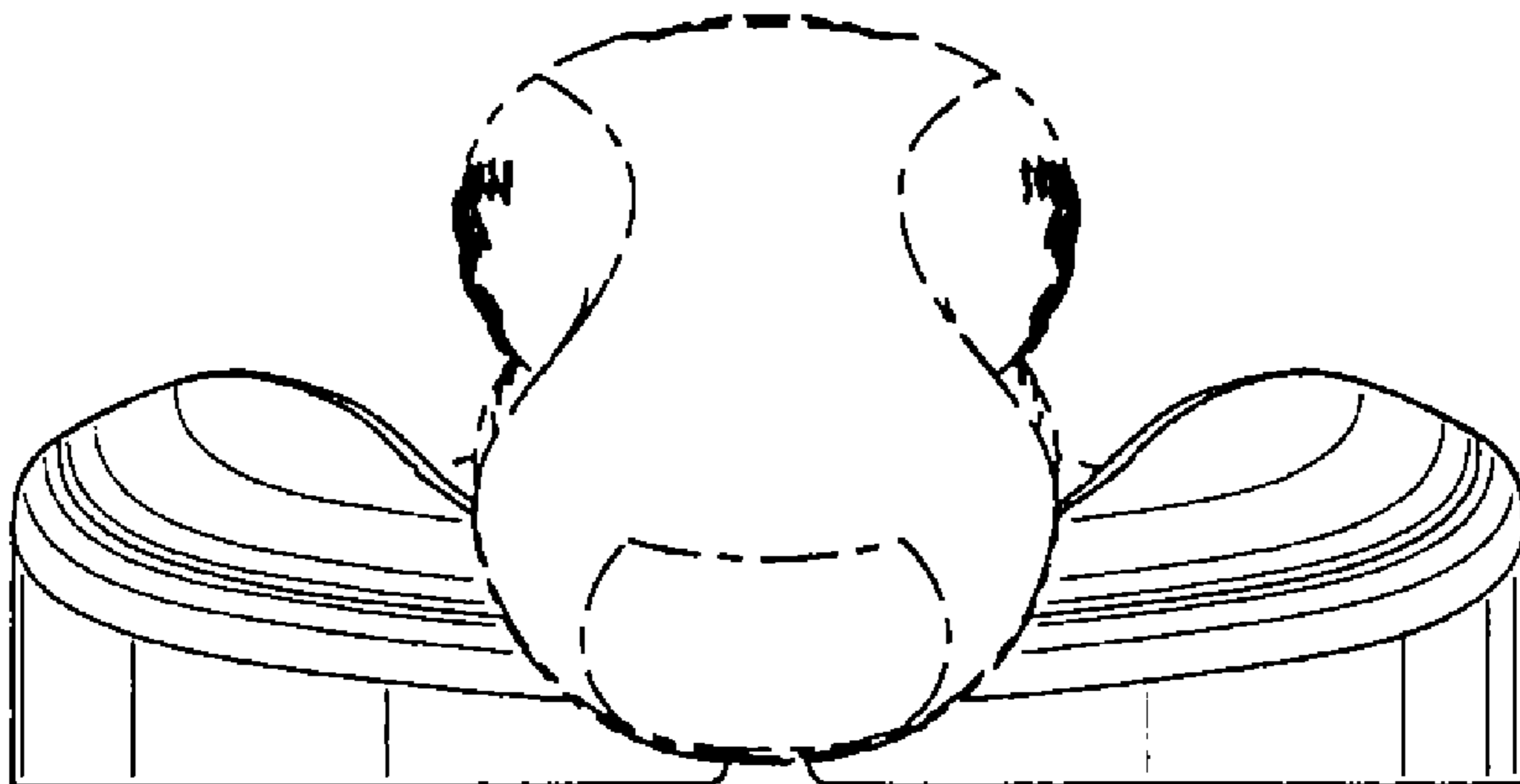

FIG. 14