



US00D574644S

(12) **United States Design Patent**
Collings

(10) **Patent No.:** **US D574,644 S**

(45) **Date of Patent:** **** Aug. 12, 2008**

(54) **DETACHABLY MOUNTED HEAD RESTRAINT**

(75) Inventor: **Simon J. Collings**, Lunenburg (DE)

(73) Assignee: **Son K. Nguyen**, Sacramento, CA (US)

(**) Term: **14 Years**

(21) Appl. No.: **29/286,117**

(22) Filed: **Apr. 23, 2007**

(51) **LOC (8) Cl.** **06-01**

(52) **U.S. Cl.** **D6/501**

(58) **Field of Classification Search** D6/334-336,
D6/356, 366, 367, 491, 500-502, 601; 248/118;
297/220, 391, 394, 397; D14/205; 381/74,
381/301, 378, 381, 384, 388; 725/68
See application file for complete search history.

(56) **References Cited**

U.S. PATENT DOCUMENTS

2,474,386	A *	6/1949	Volkman	381/378
3,384,719	A *	5/1968	Lanzara	381/301
4,991,222	A *	2/1991	Nixdorf	381/388
5,154,477	A *	10/1992	Lacy	297/397
D353,497	S *	12/1994	Bergkvist et al.	D6/356
5,640,458	A *	6/1997	Nishiguchi et al.	381/74
D436,271	S *	1/2001	Corti	D6/501
7,124,425	B1 *	10/2006	Anderson et al.	725/68
D539,572	S	4/2007	Nguyen		

D552,077	S *	10/2007	Brunner et al.	D14/205
2003/0103637	A1 *	6/2003	Huang	381/74
2005/0179300	A1 *	8/2005	O'Connor et al.	297/391
2006/0083397	A1 *	4/2006	Chen	381/378

* cited by examiner

Primary Examiner—Mimosa De

(74) *Attorney, Agent, or Firm*—R. Michael West

(57) **CLAIM**

The ornamental design for a detachably mounted head restraint, as shown and described.

DESCRIPTION

FIG. 1 is a left front perspective of a detachably mounted head restraint, showing my new design;

FIG. 2 is a top plan view, thereof;

FIG. 3 is a front elevational view, thereof;

FIG. 4 is a rear elevational view, thereof;

FIG. 5 is an elevational view of one side, the opposite side elevational view being a mirror image, thereof;

FIG. 6 is a bottom plan view, thereof; and,

FIG. 7 is a perspective view taken to a reduced scale.

The broken line representations of the head and shoulders of a person, the portion of a seat and headrest, and the attachment straps shown in FIG. 7 are included solely for illustrative purposes, forming no part of the claimed design.

1 Claim, 2 Drawing Sheets

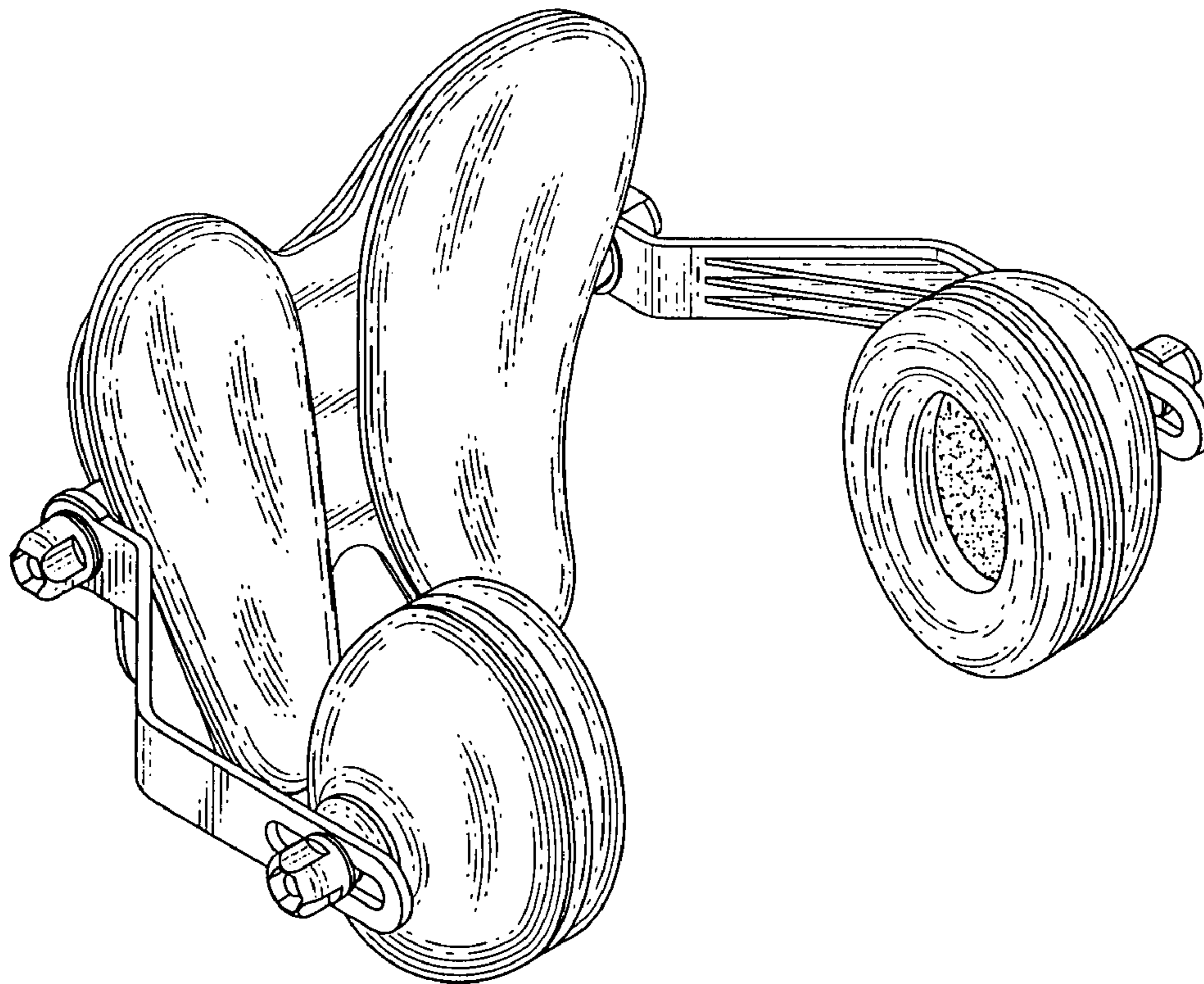

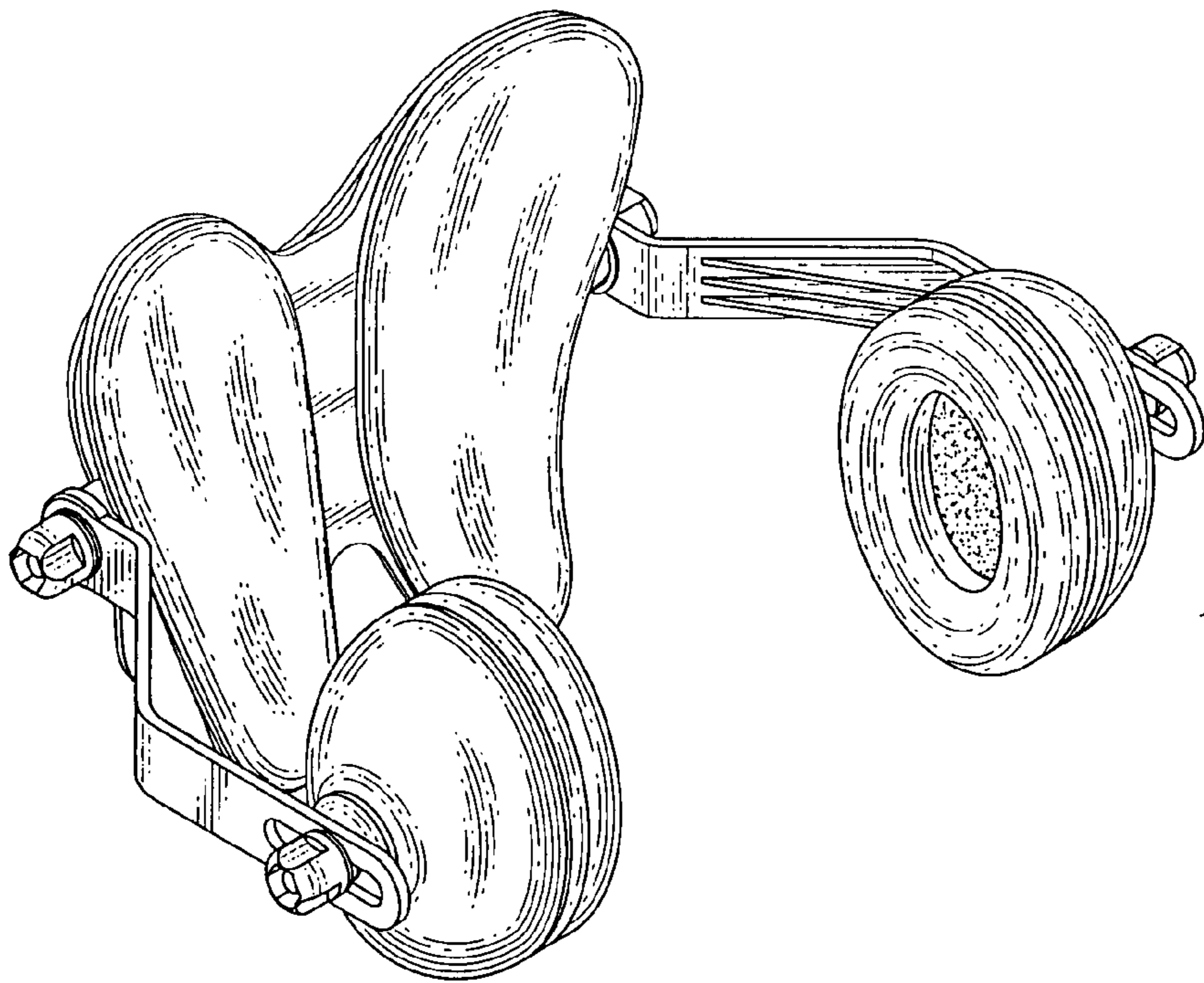

Fig. 1

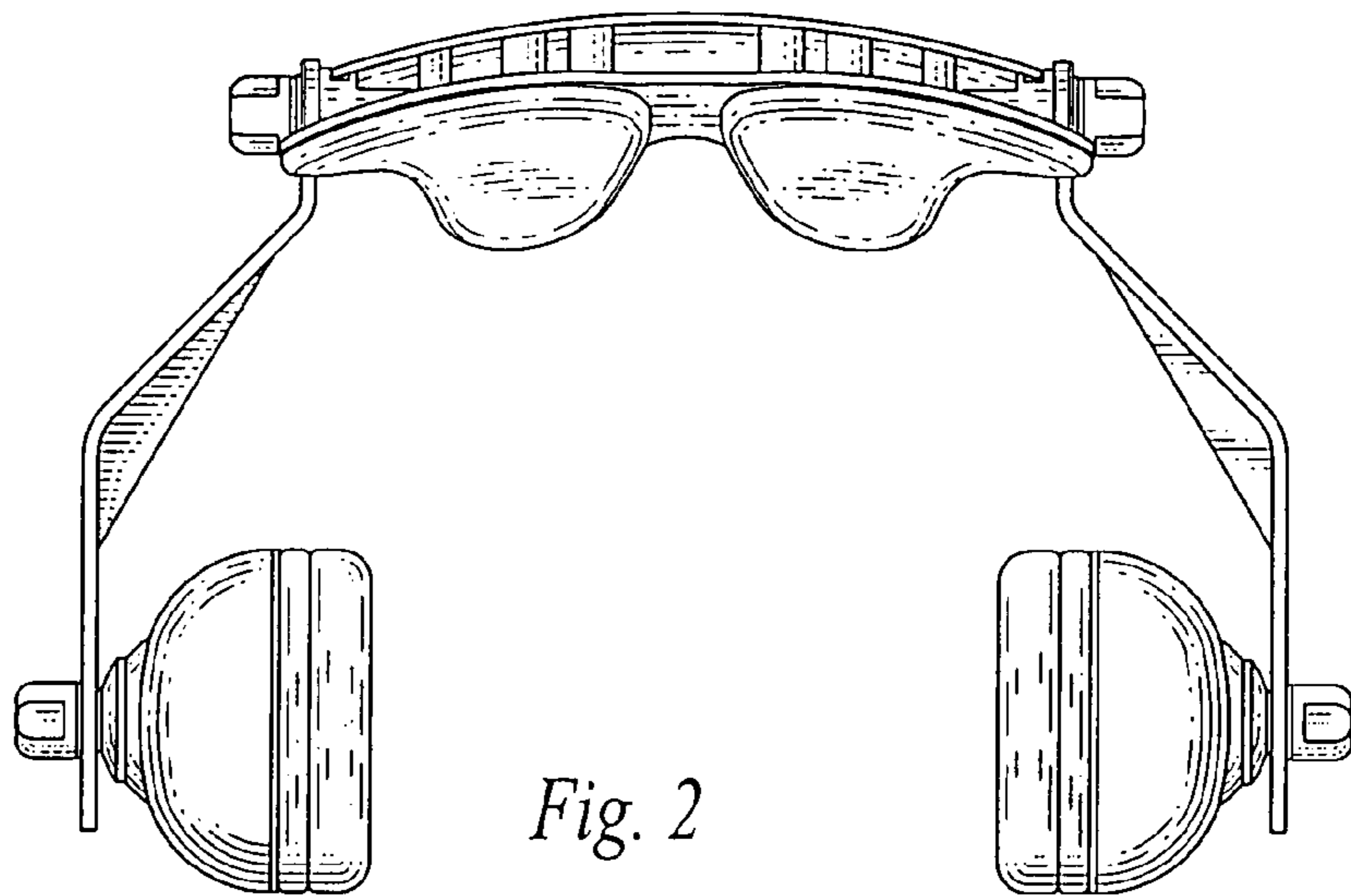

Fig. 2

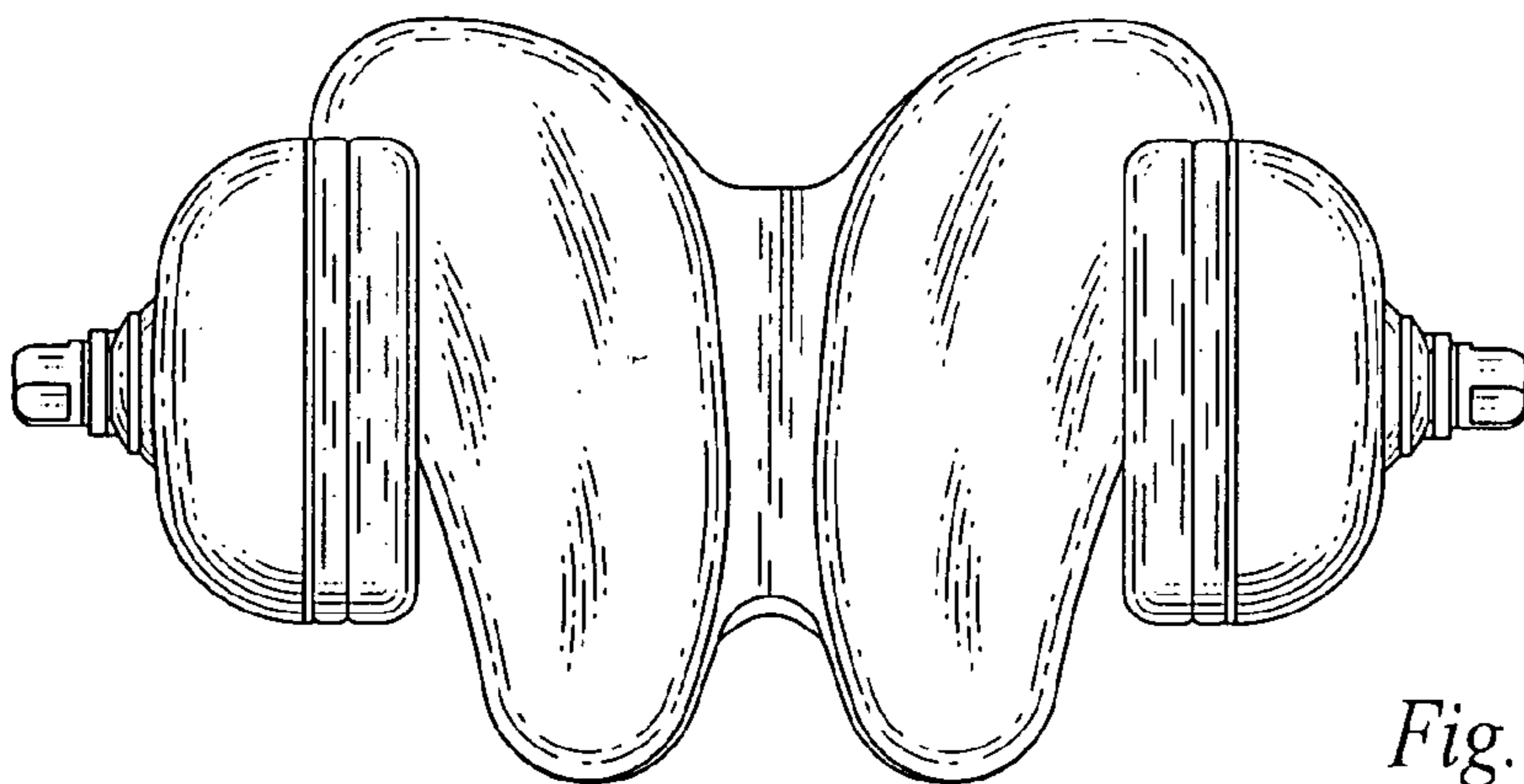

Fig. 3

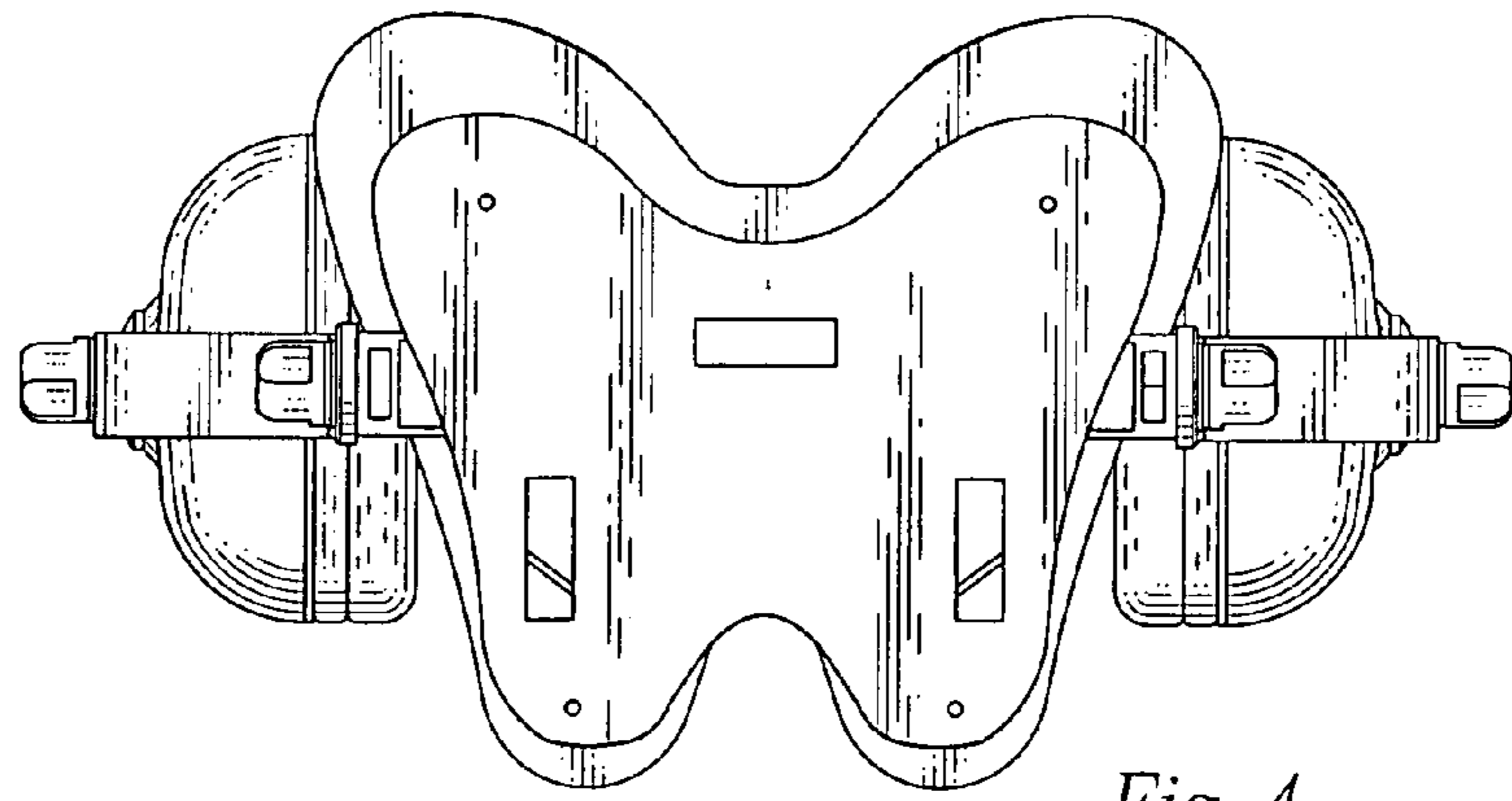

Fig. 4

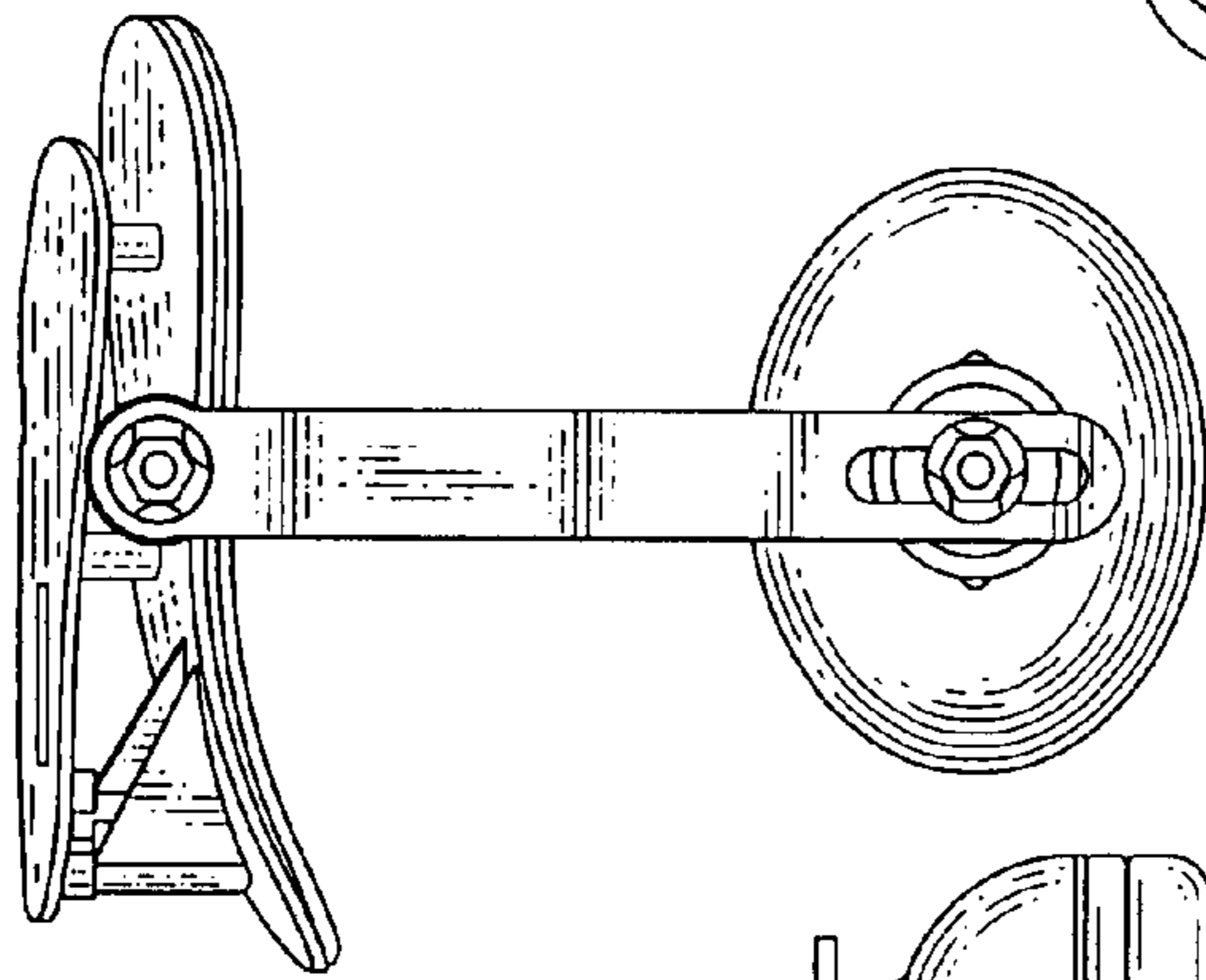

Fig. 5

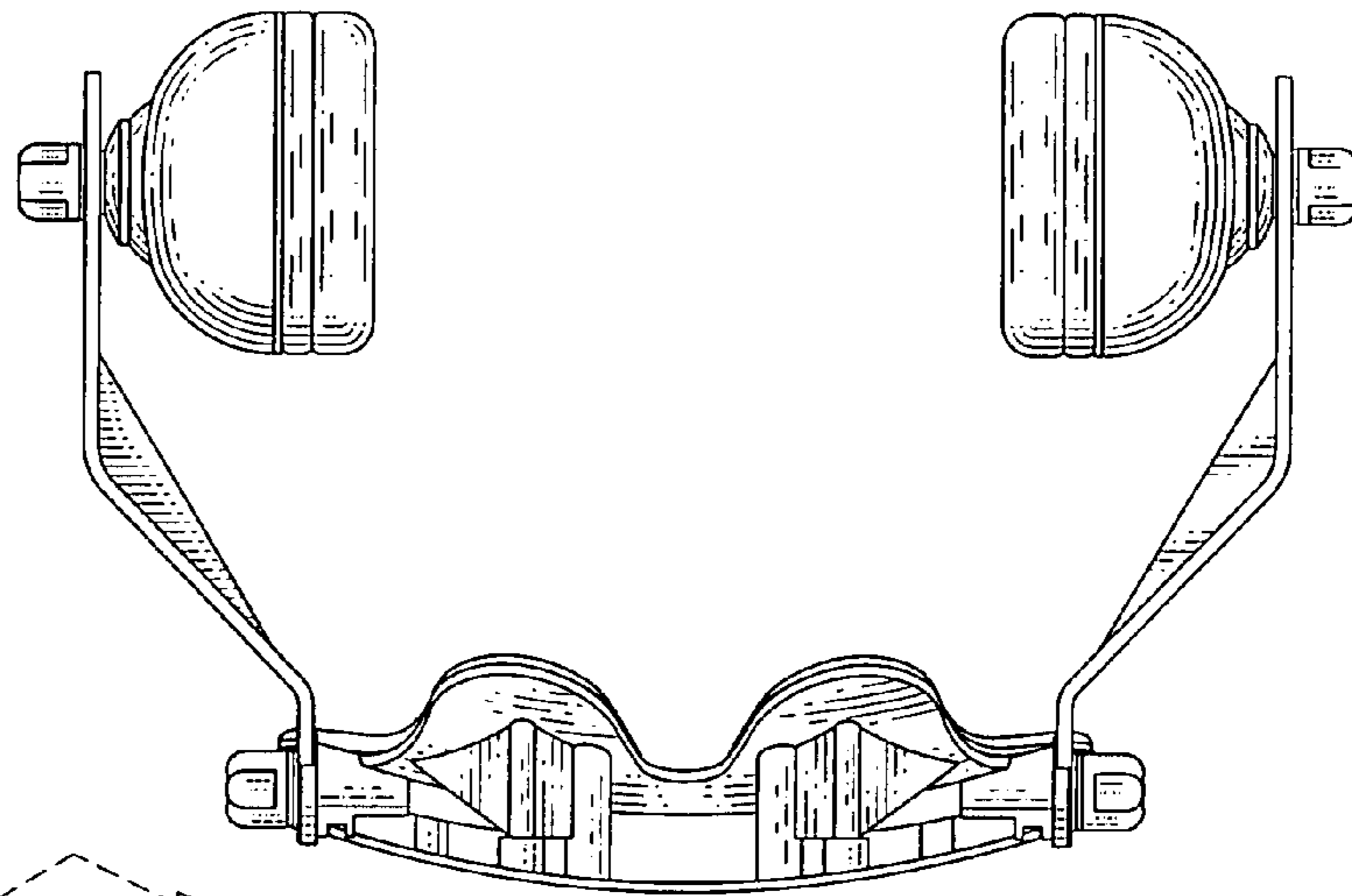

Fig. 6

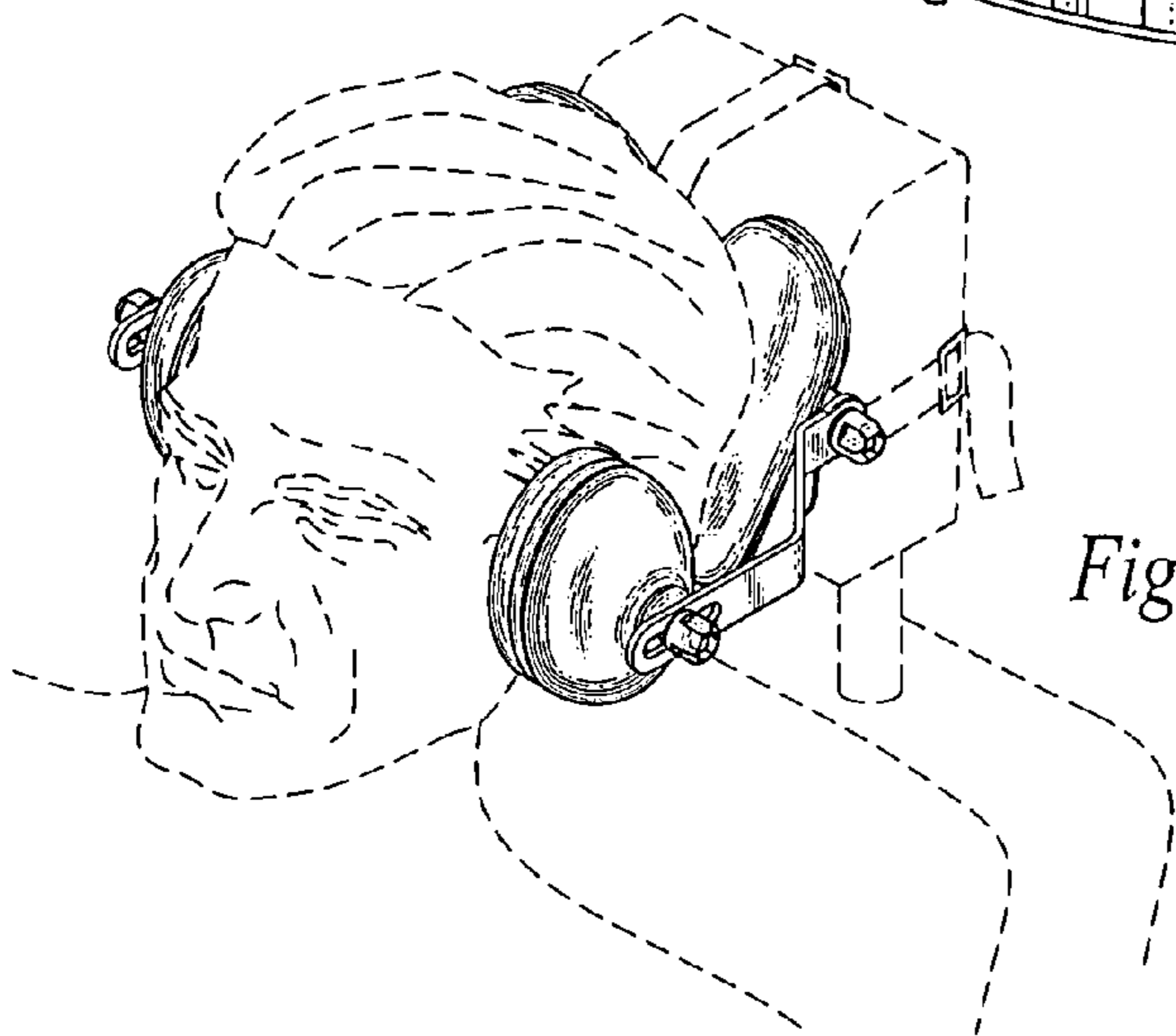

Fig. 7