



US00D574625S

(12) **United States Design Patent**
Schmitt

(10) **Patent No.:** **US D574,625 S**

(45) **Date of Patent:** **** Aug. 12, 2008**

(54) **SETTEE**

(75) Inventor: **Jack Schmitt**, San Juan Capistrano, CA
(US)

(73) Assignee: **Amini Innovation Corp.**, Pico Rivera,
CA (US)

(**) Term: **14 Years**

(21) Appl. No.: **29/294,738**

(22) Filed: **Jan. 25, 2008**

(51) **LOC (8) Cl.** **06-01**

(52) **U.S. Cl.** **D6/381**

(58) **Field of Classification Search** D6/334,
D6/349, 355, 357, 367, 368, 370, 374-381,
D6/500-502; 297/175, 232, 233, 283.2,
297/283.3, 445.1, 448.1, 452.12, 452.38,
297/452.48, 461, 462; 5/12.1, 12.2

See application file for complete search history.

(56) **References Cited**

U.S. PATENT DOCUMENTS

D211,573 S * 7/1968 Granger D6/334
D240,376 S * 7/1976 Adkinson D6/334
D366,768 S * 2/1996 Martin D6/334
D453,426 S * 2/2002 Juhasz D6/379

D485,996 S * 2/2004 Stanton D6/334
D536,183 S * 2/2007 Schmitt D6/334
D569,634 S * 5/2008 Schmitt D6/334

* cited by examiner

Primary Examiner—Sandra Snapp

(74) *Attorney, Agent, or Firm*—Cislo & Thomas, LLP

(57) **CLAIM**

I claim the ornamental design for a settee, as shown and described.

DESCRIPTION

FIG. 1 is a perspective view of my settee;
FIG. 2 is a front view thereof;
FIG. 3 is a right side view thereof;
FIG. 4 is a left side view thereof;
FIG. 5 is a top view thereof;
FIG. 6 is a rear view thereof;
FIG. 7 is a close-up view of the design at the top thereof; and,
FIG. 8 is a close-up view of the design at the bottom of my settee.

The broken lines shown in the drawings are for environmental purposes only and form no part of the claimed design.

1 Claim, 6 Drawing Sheets

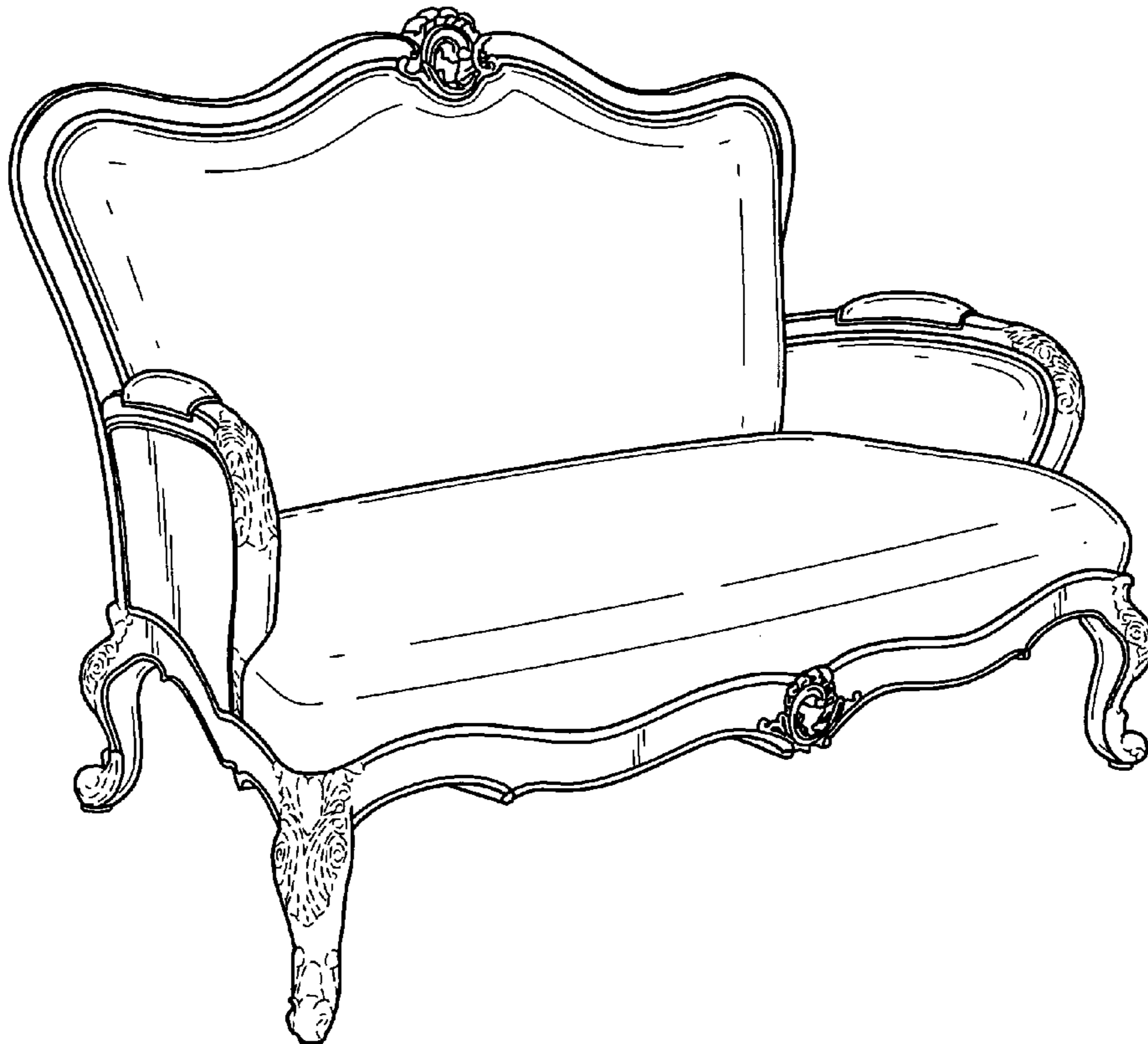
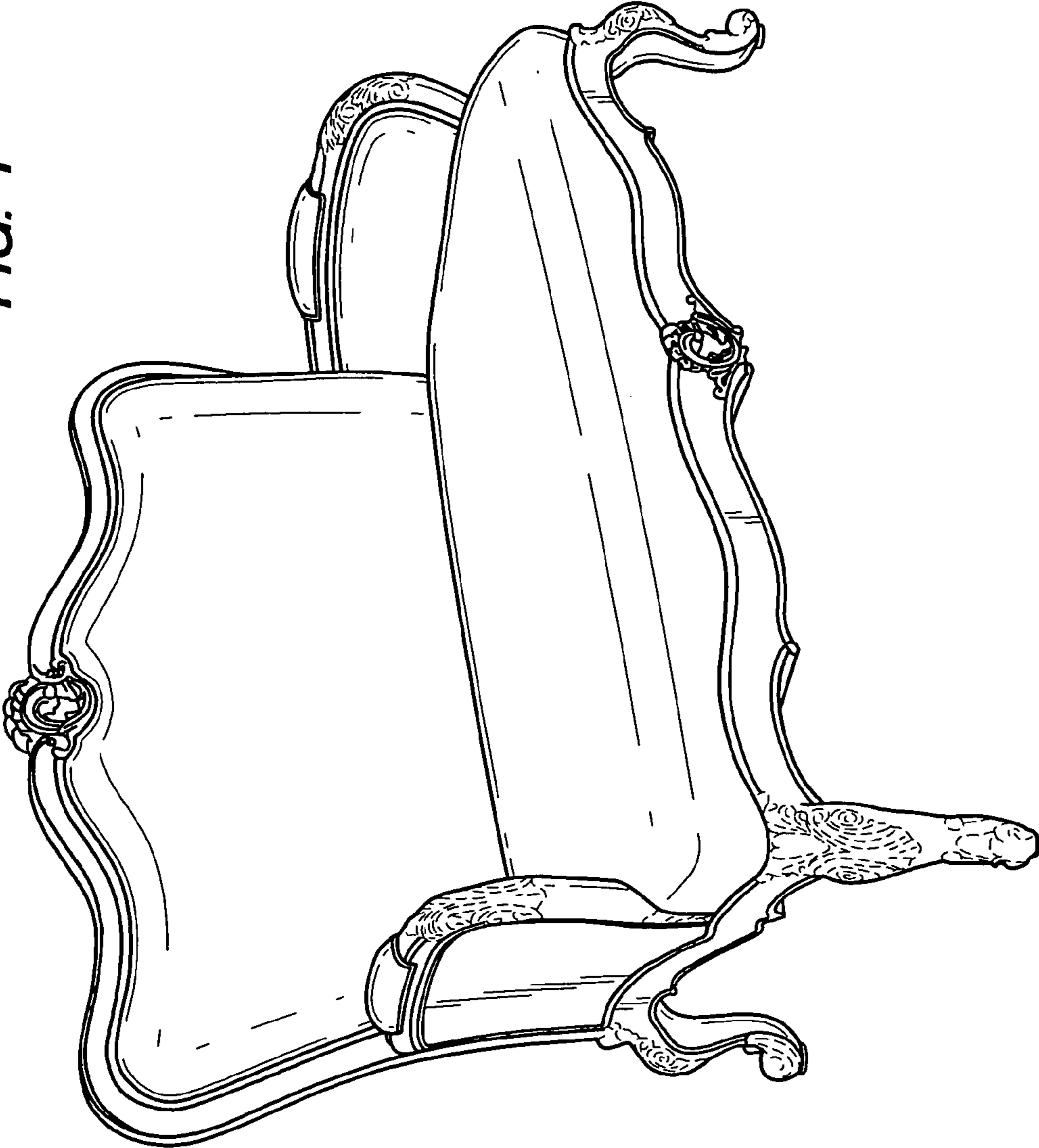

FIG. 1



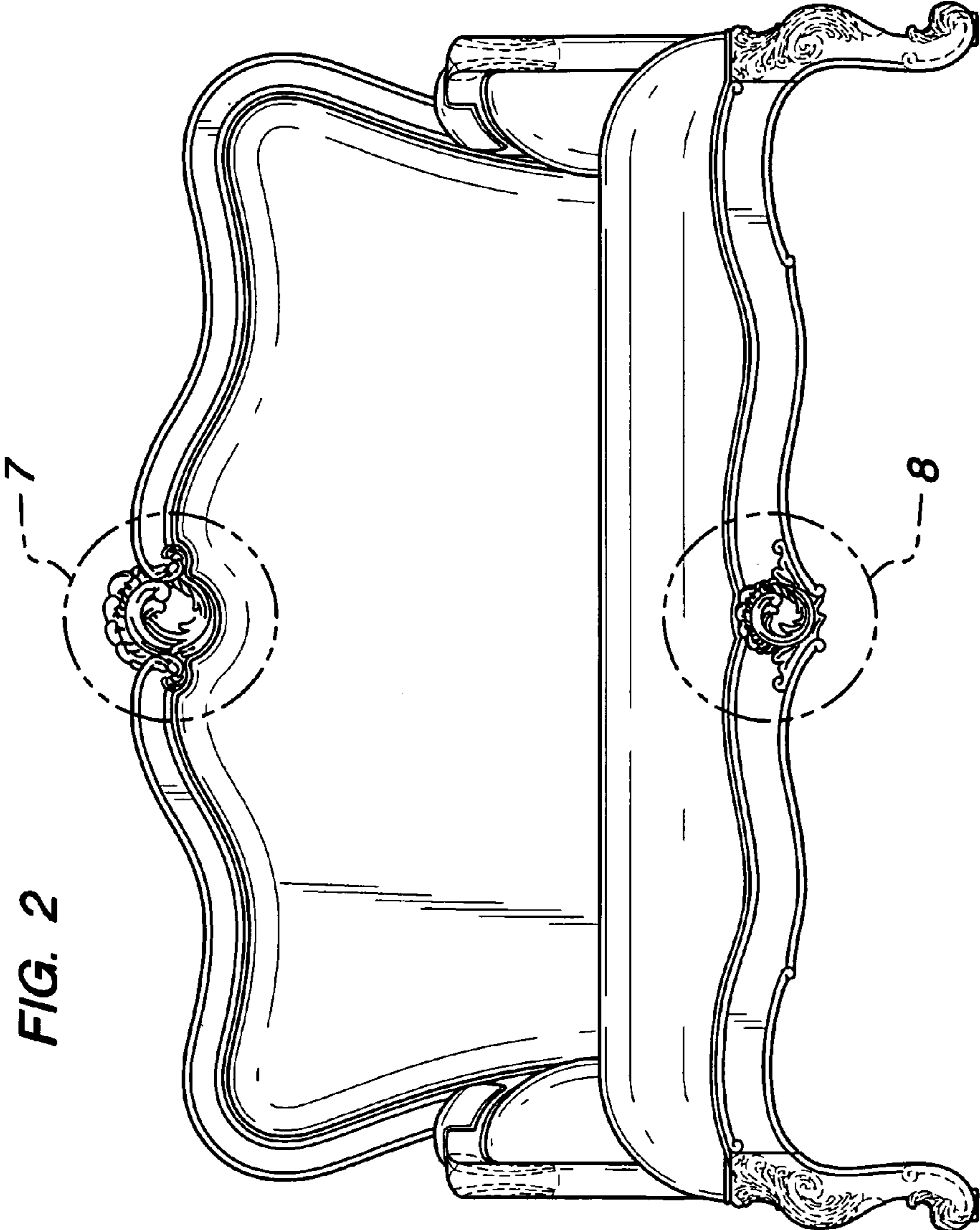

FIG. 4

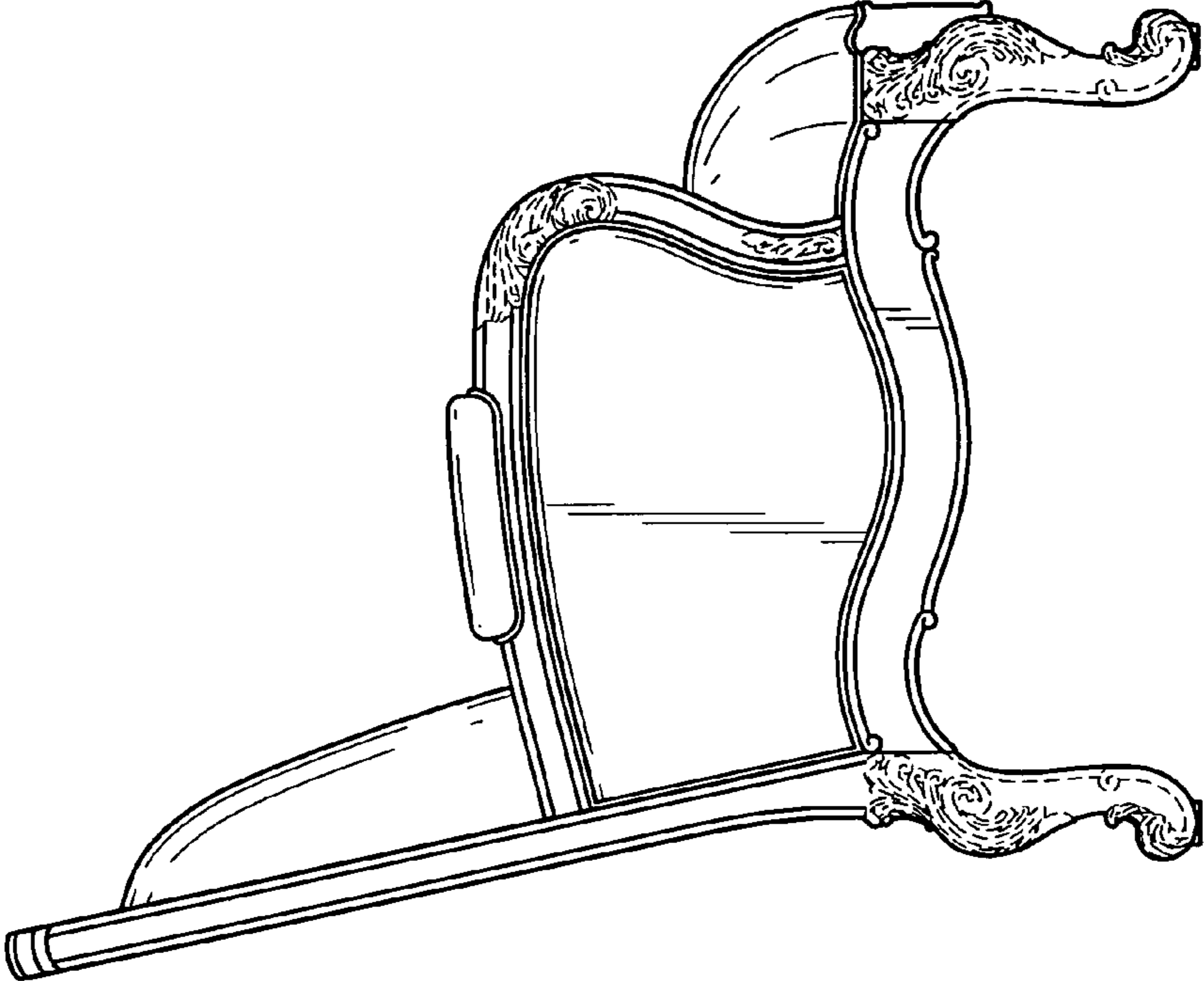

FIG. 3

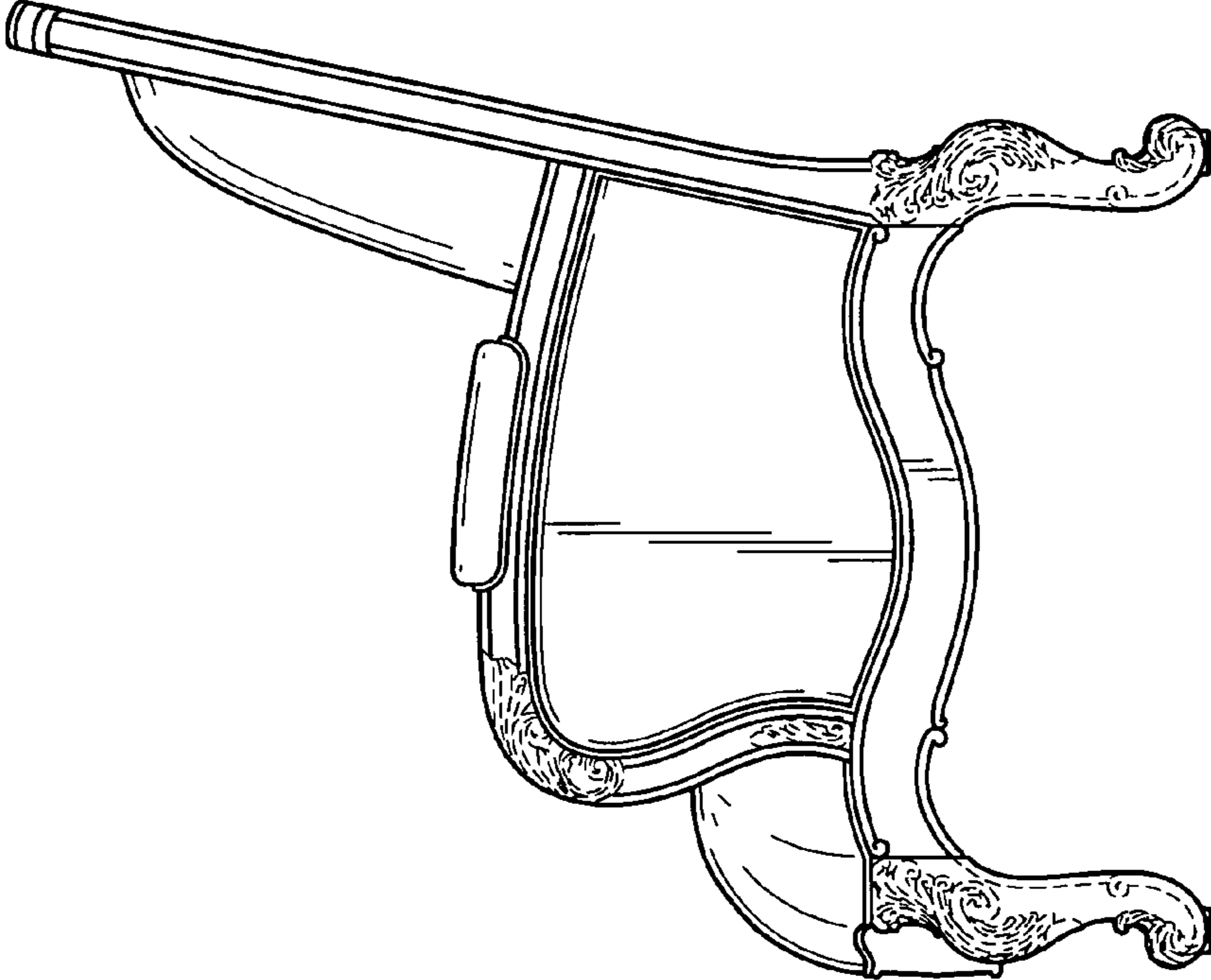
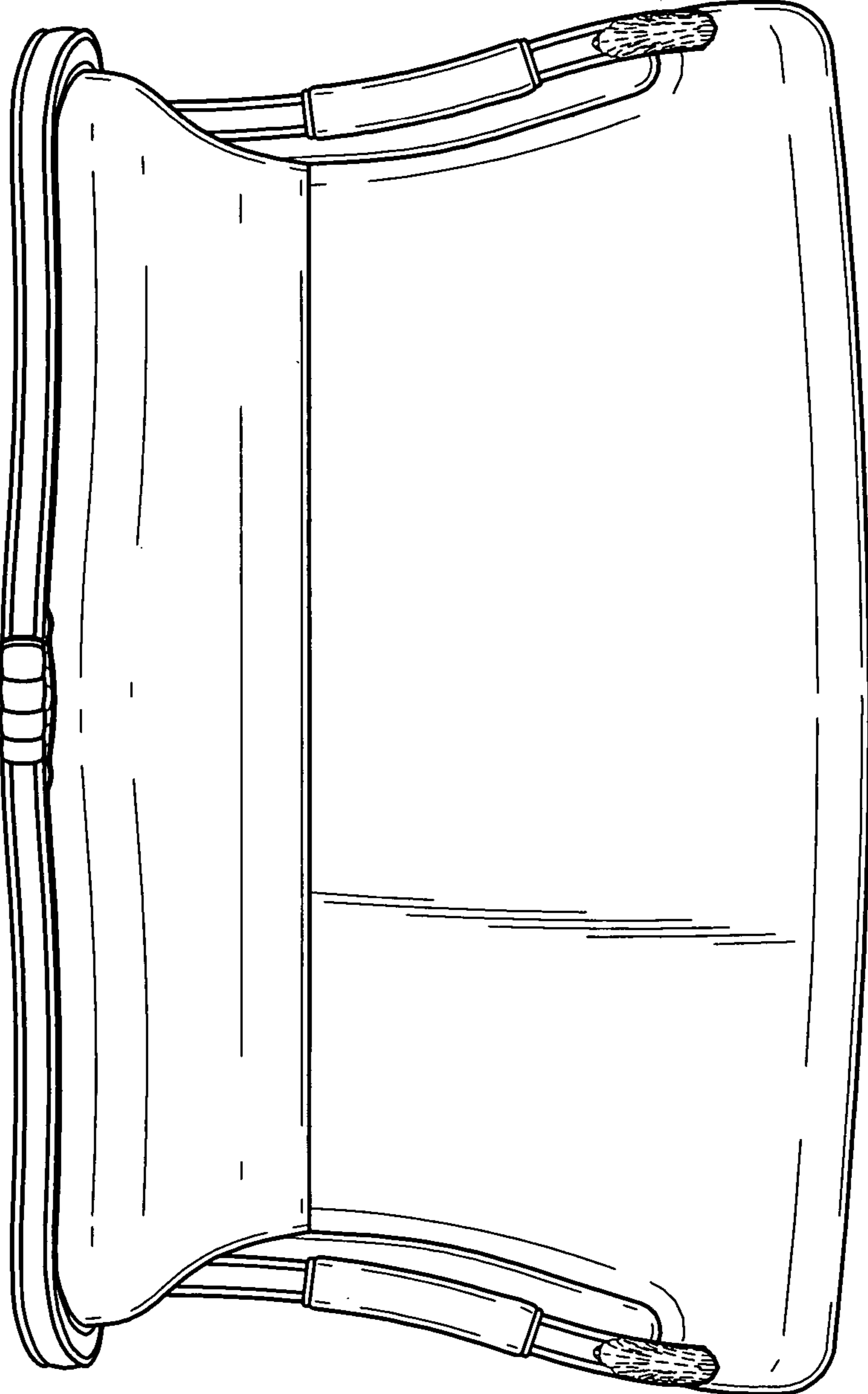

FIG. 5



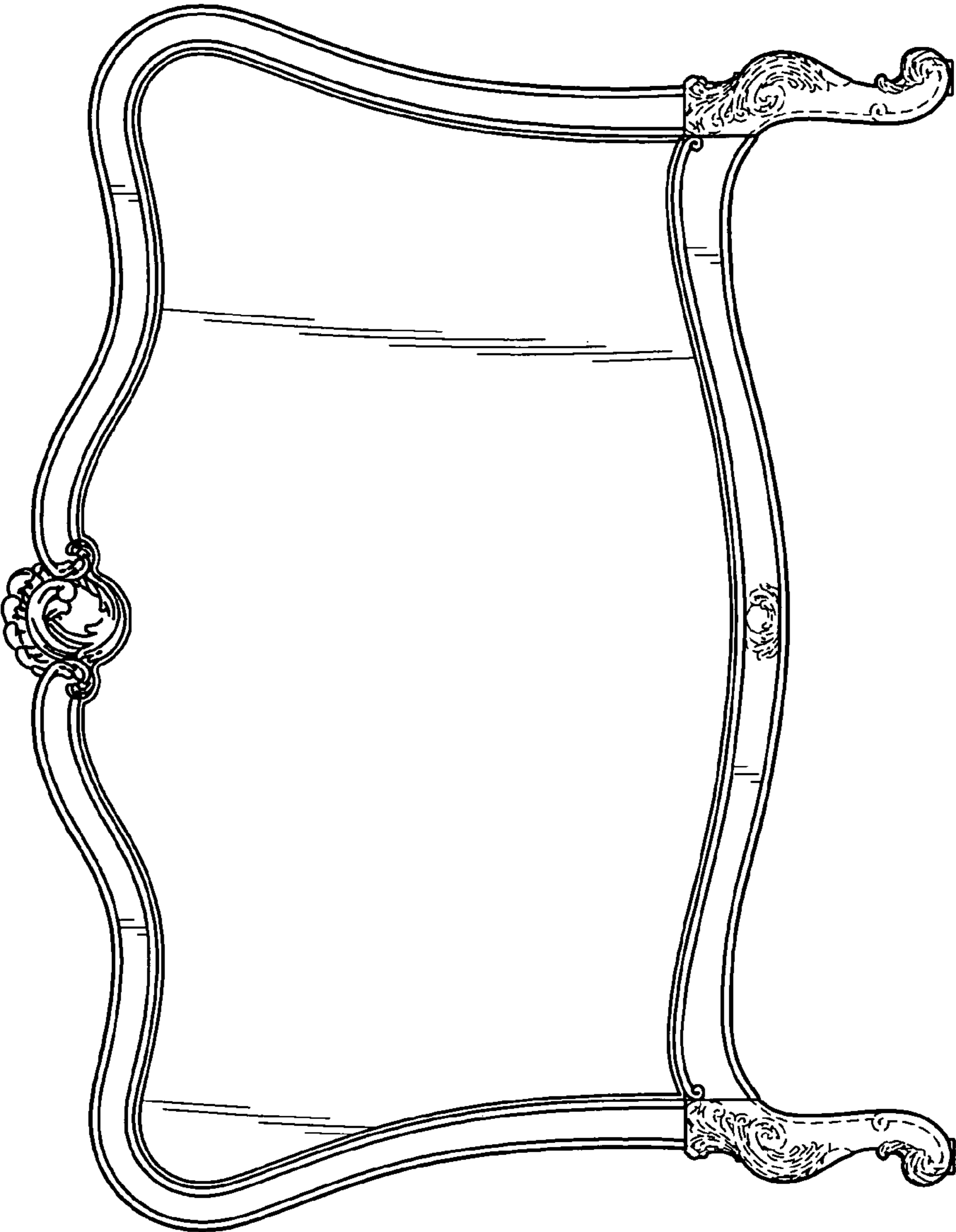

FIG. 6

FIG. 7

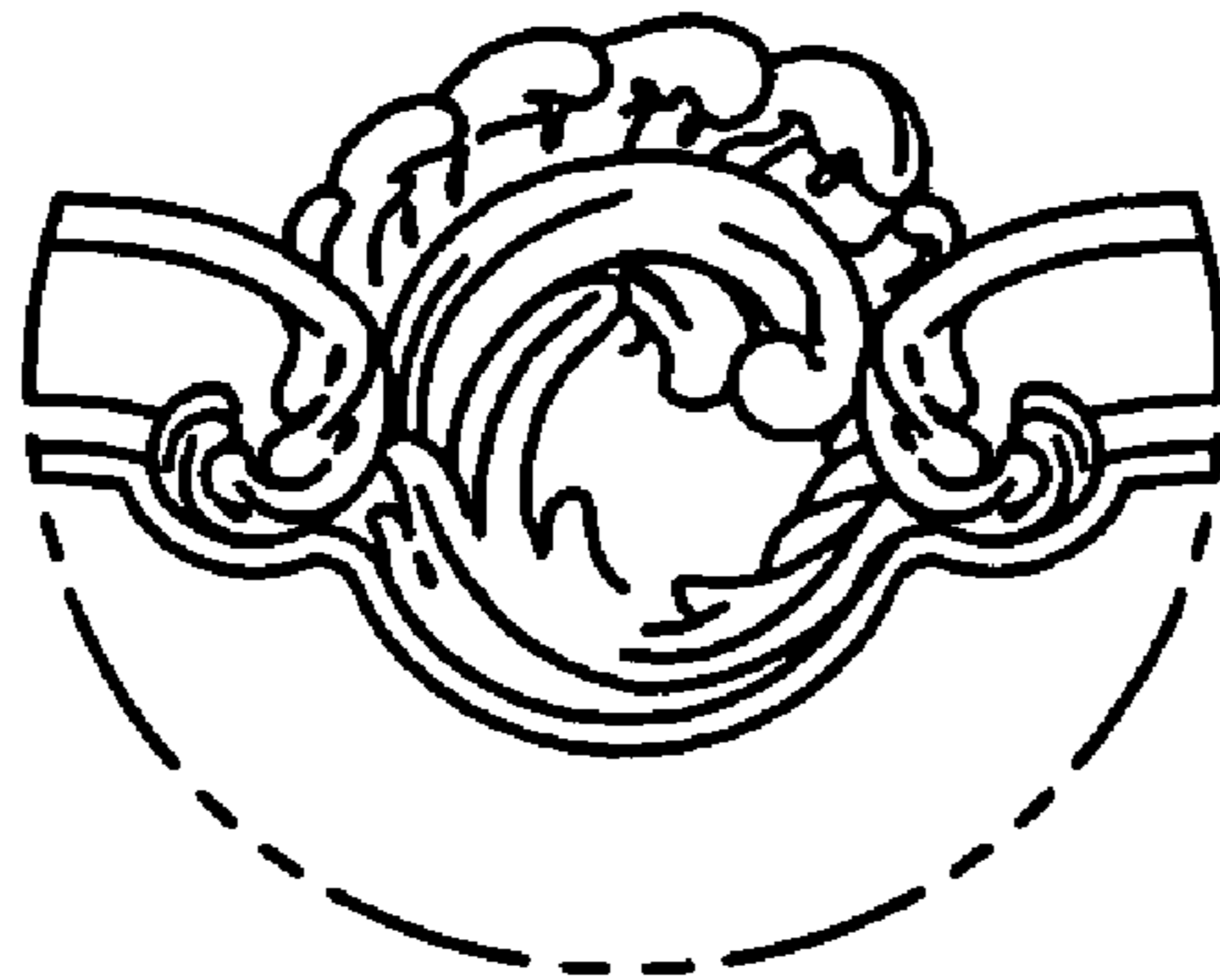

FIG. 8

