



US00D574352S

(12) **United States Design Patent**  
**Cha et al.**

(10) **Patent No.:** **US D574,352 S**

(45) **Date of Patent:** **\*\* Aug. 5, 2008**

(54) **CELLULAR PHONE**

(75) Inventors: **Seong-Won Cha**, Seoul (KR);  
**Yoon-Young Cho**, Seoul (KR);  
**Chang-Soo Lee**, Incheon-si (KR)

(73) Assignee: **Samsung Electronics Co., Ltd.**,  
Suwon-Si (KR)

(\*\*) Term: **14 Years**

(21) Appl. No.: **29/287,865**

(22) Filed: **Sep. 27, 2007**

(51) **LOC (8) Cl.** ..... **14-03**

(52) **U.S. Cl.** ..... **D14/138**

(58) **Field of Classification Search** ..... D14/138,  
D14/496, 341-347; 455/575.3, 575.1; D21/517  
See application file for complete search history.

(56) **References Cited**

**U.S. PATENT DOCUMENTS**

D506,454 S *	6/2005	Kim et al.	.....	D14/138
D508,035 S *	8/2005	Kim et al.	.....	D14/138
D509,816 S *	9/2005	Kim et al.	.....	D14/138
D510,079 S *	9/2005	Kim et al.	.....	D14/138
D512,038 S *	11/2005	Kim et al.	.....	D14/138
D519,971 S *	5/2006	Morita et al.	.....	D14/138
D520,484 S *	5/2006	Lee et al.	.....	D14/138
D521,968 S *	5/2006	Jung et al.	.....	D14/138
D537,061 S *	2/2007	Oh	.....	D14/138
D543,172 S *	5/2007	Lee et al.	.....	D14/138
D545,798 S *	7/2007	Kimbre	.....	D14/138
D546,311 S *	7/2007	Lee	.....	D14/138
D552,060 S *	10/2007	Kim et al.	.....	D14/138
D553,110 S *	10/2007	Park et al.	.....	D14/138
D555,129 S *	11/2007	Han et al.	.....	D14/138
D557,231 S *	12/2007	Chung et al.	.....	D14/138
D559,216 S *	1/2008	Sheu	.....	D14/138
D560,643 S *	1/2008	Kim et al.	.....	D14/138
D563,351 S *	3/2008	Baik et al.	.....	D14/138
D563,360 S *	3/2008	Baik et al.	.....	D14/138
D563,361 S *	3/2008	Moon et al.	.....	D14/138

D563,365 S *	3/2008	Kim	.....	D14/138
D563,375 S *	3/2008	Kim et al.	.....	D14/138
2007/0054636 A1 *	3/2007	Ahn et al.	.....	455/128

**OTHER PUBLICATIONS**

Samsung T439 telephone, announced Nov. 2007, [online], [site visited Feb. 28, 2008]. Available from Internet ,<URL: http://www.gsmarena.com>.\*

Samsung E480 telephone, announced Nov. 2006, [online], [site visited Feb. 28, 2008]. Available from Internet ,<URL: http://www.gsmarena.com>.\*

Samsung Z600 telephone, announced Feb. 2006, [online], [site visited Feb. 28, 2008]. Available from Internet ,<URL: http://www.gsmarena.com>.\*

Samsung X680 telephone, announced 2<sup>nd</sup> quarter 2006, [online], [site visited Feb. 28, 2008]. Available from Internet ,<URL: http://www.gsmarena.com>.\*

(Continued)

*Primary Examiner*—Jeffrey D Asch

(74) *Attorney, Agent, or Firm*—Staas & Halsey LLP

(57) **CLAIM**

The ornamental design for a cellular phone, as shown and described.

**DESCRIPTION**

FIG. 1 is a perspective view of a cellular phone according to our new design;

FIG. 2 is a front elevational view thereof;

FIG. 3 is a rear elevational view thereof;

FIG. 4 is a left side elevational view thereof;

FIG. 5 is a right side elevational view thereof;

FIG. 6 is a top plan view thereof;

FIG. 7 is a bottom plan view thereof; and,

FIG. 8 is a front elevational view of the cellular phone according to our new design in a state in which the cellular phone is open.

**1 Claim, 8 Drawing Sheets**

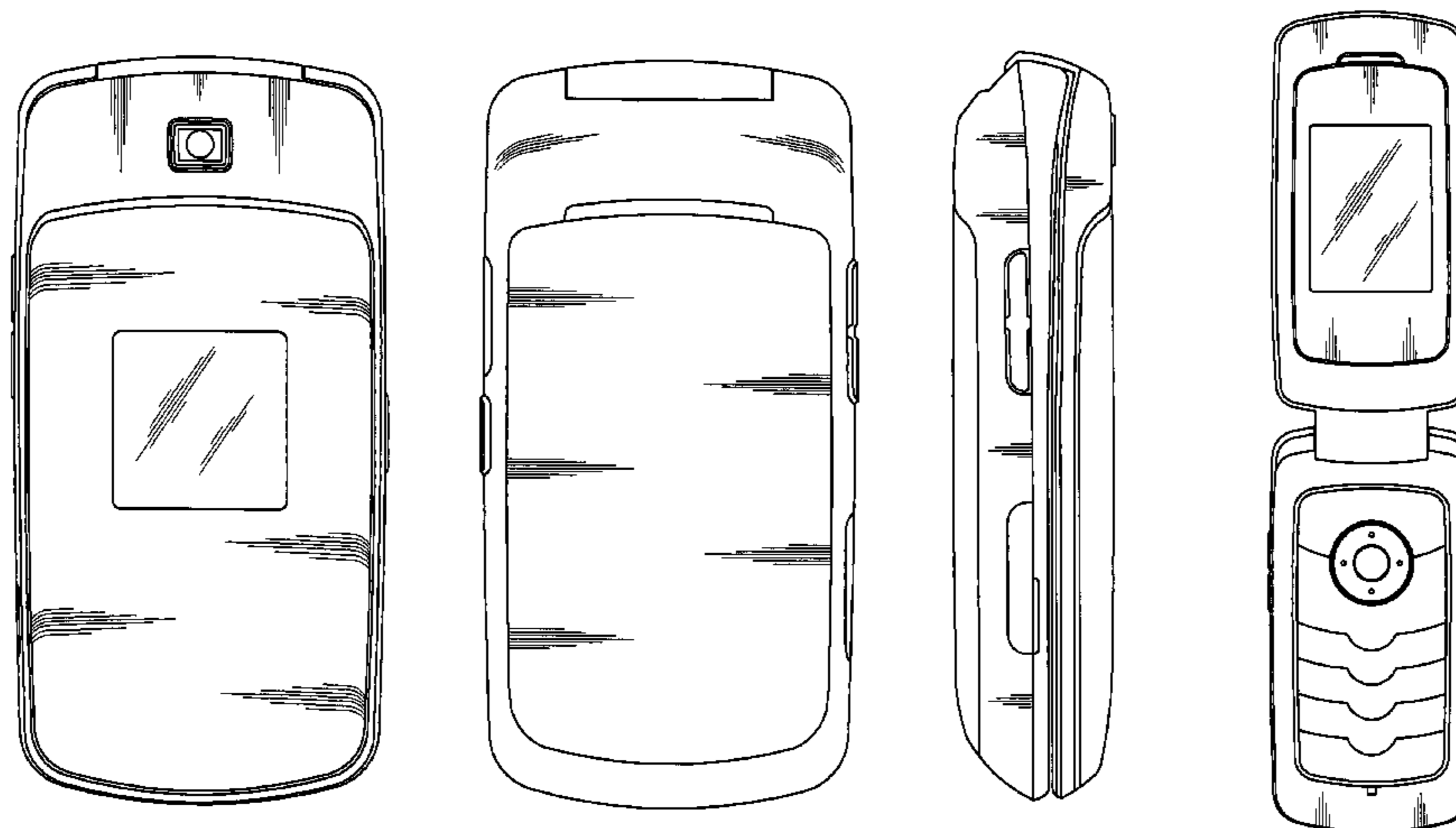

OTHER PUBLICATIONS

Motorola V501 telephone, announced 1st quarter 2004, [online], [site visited Feb. 28, 2008]. Available from Internet ,<URL: <http://www.gsmarena.com>>.\*

Sony Ericsson Z310 telephone, announced Dec. 2006, [online], [site visited Feb. 28, 2008]. Available from Internet ,<URL: <http://www.gsmarena.com>>.\*

Sony Ericsson Z530 telephone, announced Apr. 2006, [online], [site visited Feb. 28, 2008]. Available from Internet ,<URL: <http://www.gsmarena.com>>.\*

LG KP202 telephone, announced May 2007, [online], [site visited Feb. 28, 2008]. Available from Internet ,<URL: <http://www.gsmarena.com>>.\*

\* cited by examiner

FIG.1

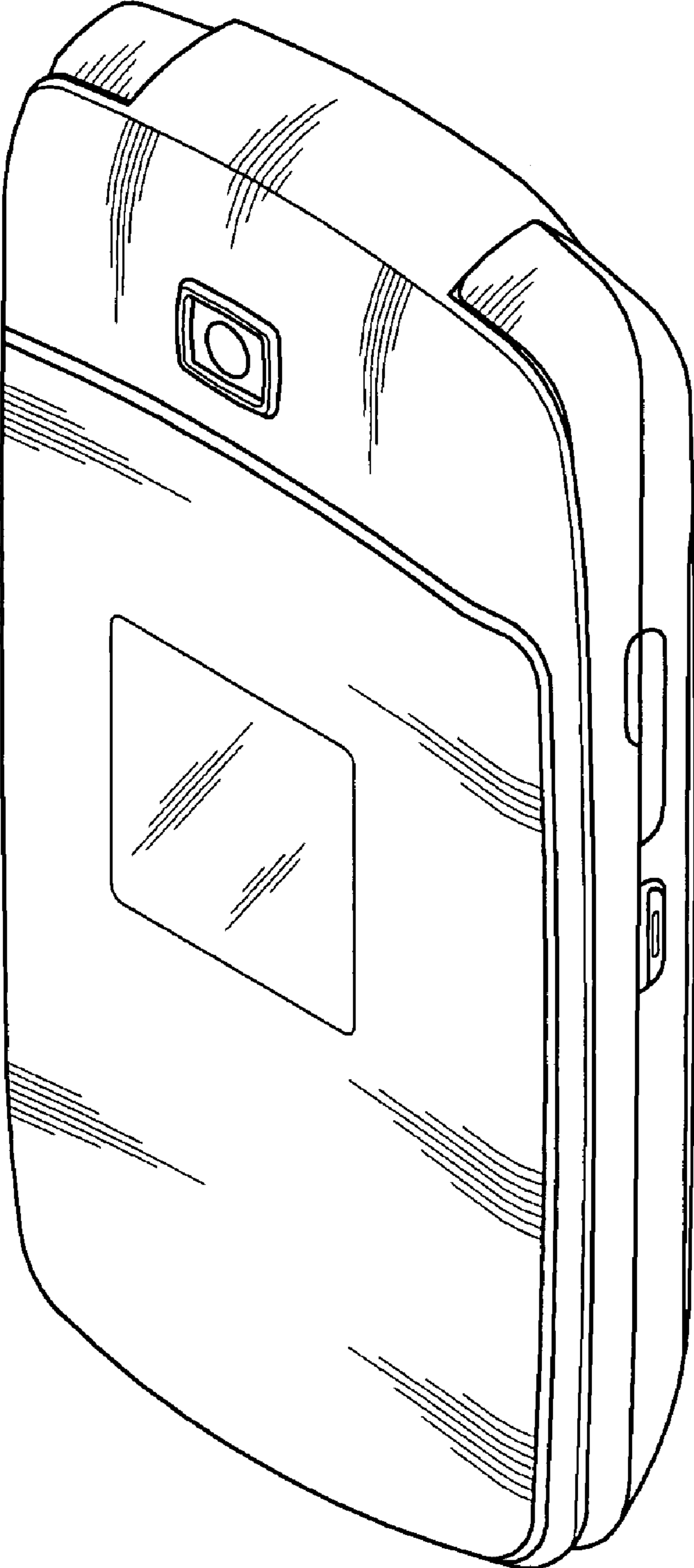

FIG.2

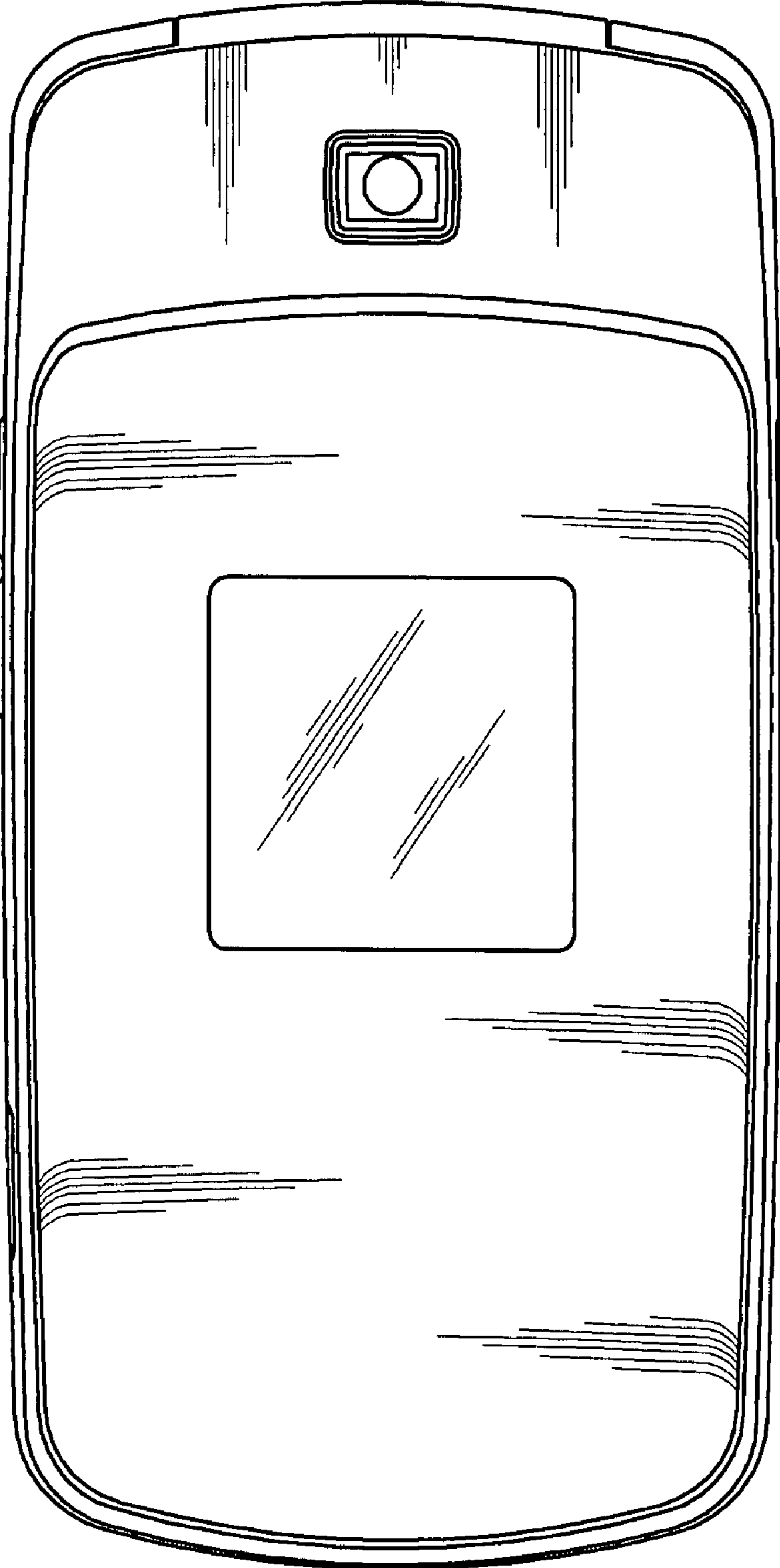

FIG.3

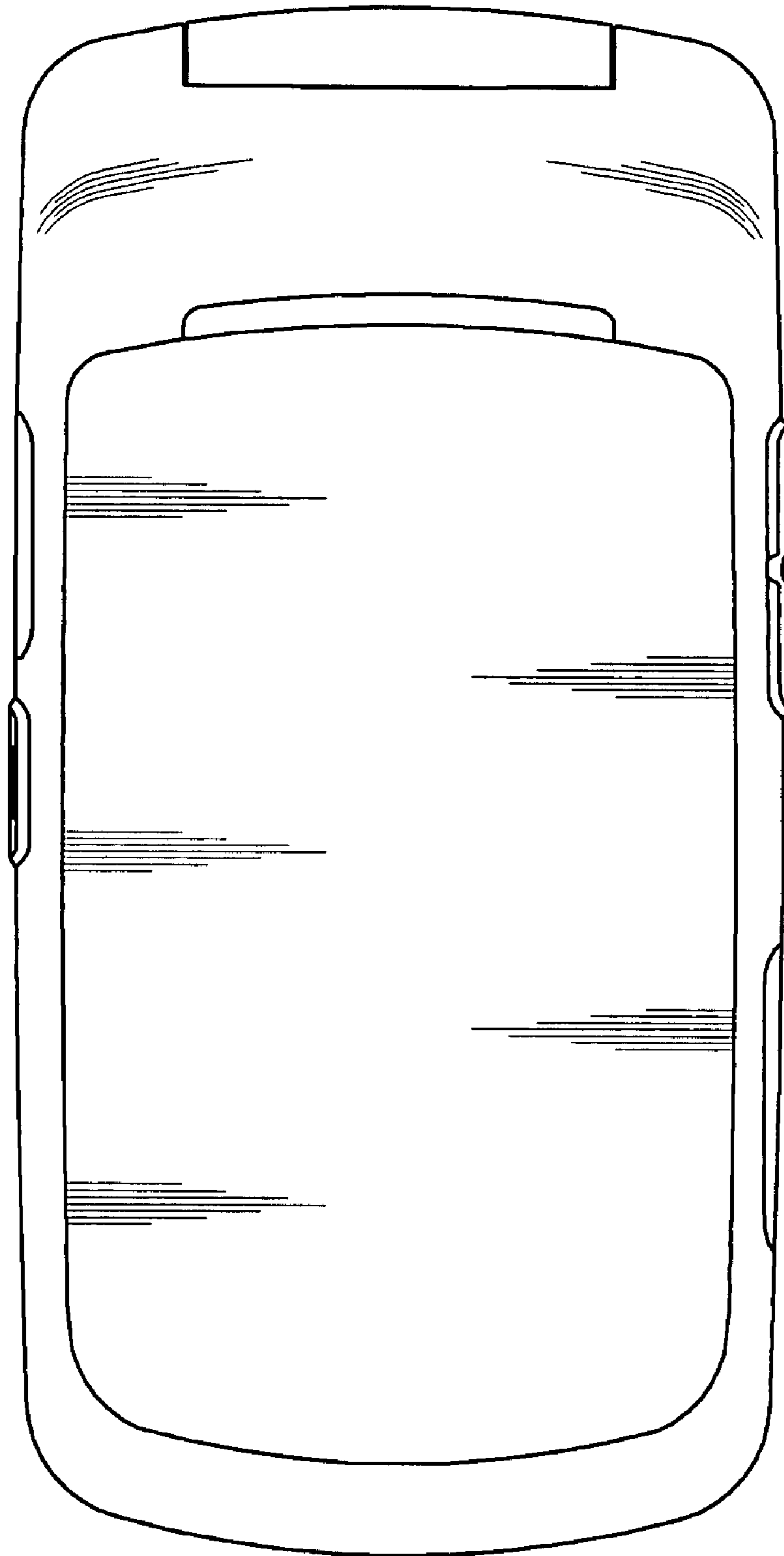

FIG.4

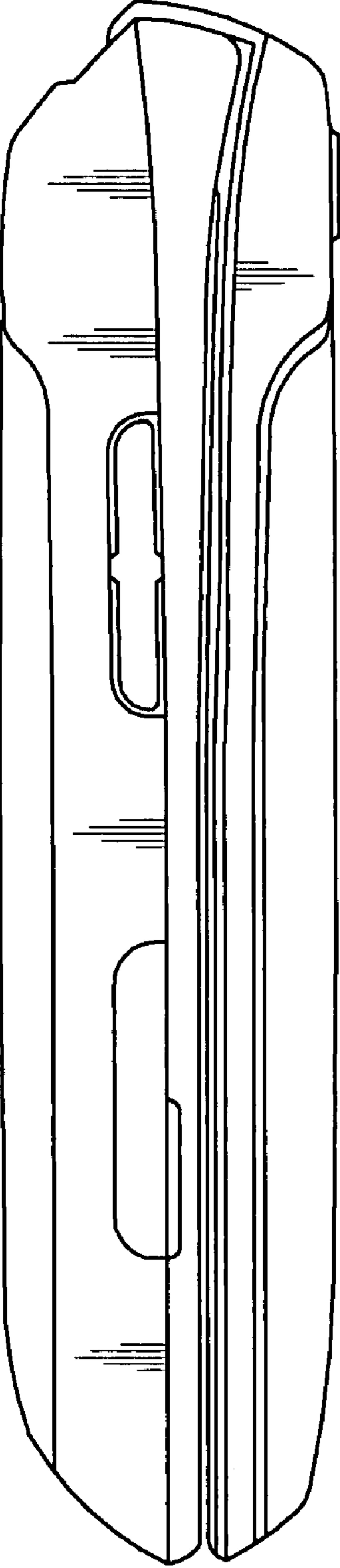

FIG. 5

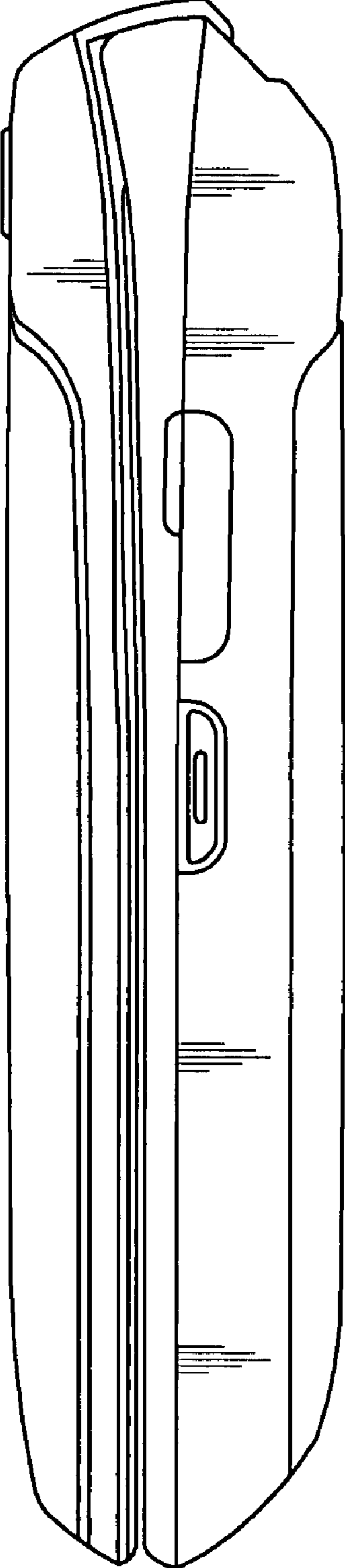

FIG.6

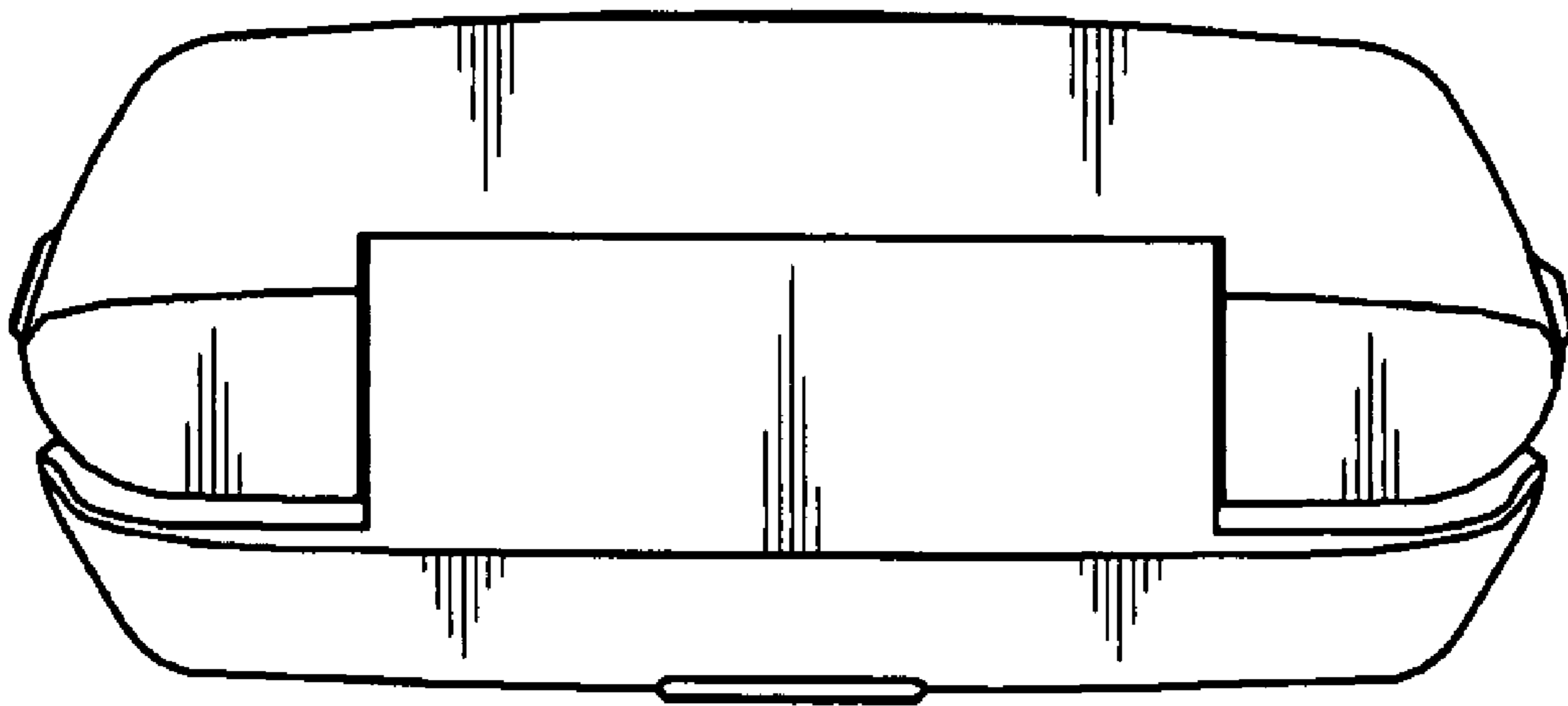



FIG. 7

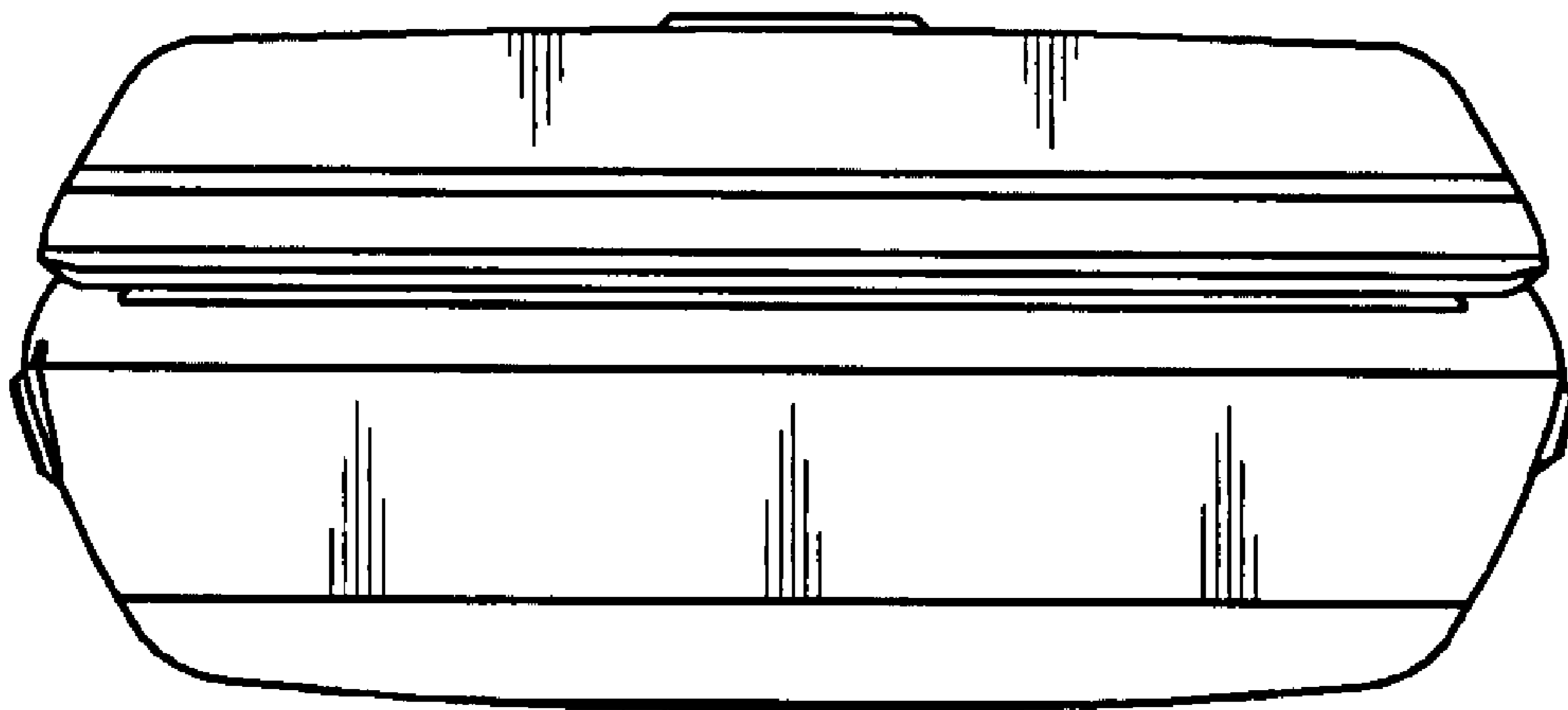

FIG.8

