



US00D574315S

(12) **United States Design Patent**
Swails et al.

(10) **Patent No.:** **US D574,315 S**
(45) **Date of Patent:** **** Aug. 5, 2008**

(54) **EXPEDITION VEHICLE**

(75) Inventors: **William Swails**, Broomfield, CO (US);
Michele Connolly, Superior, CO (US);
Kyle Hodde, Erie, CO (US)

(73) Assignee: **Earthroamer.com LLC**, Broomfield,
CO (US)

(**) Term: **14 Years**

(21) Appl. No.: **29/295,247**

(22) Filed: **Sep. 24, 2007**

(51) **LOC (8) Cl.** **12-16**

(52) **U.S. Cl.** **D12/401**

(58) **Field of Classification Search** D12/400-405;
224/401; 296/159, 161, 164, 165, 175; 135/88.13
See application file for complete search history.

(56) **References Cited**

U.S. PATENT DOCUMENTS

D188,717 S *	8/1960	McNamee	D12/404
D202,617 S *	10/1965	Foss	D12/404
D208,356 S *	8/1967	Oliver	D12/403
3,658,375 A *	4/1972	Bowen	296/164
3,659,893 A *	5/1972	Steele	296/164
3,708,199 A *	1/1973	Throssell	296/164
3,850,470 A *	11/1974	Trelle	296/175
D246,365 S *	11/1977	Floyd	D12/405
D247,711 S *	4/1978	Pittman	D12/403
4,088,363 A *	5/1978	Palmer	296/161
D255,027 S *	5/1980	Hemminger	D12/403
D272,333 S *	1/1984	Potterbaum et al.	D12/401
4,652,040 A *	3/1987	Mahan	296/159
D291,074 S *	7/1987	Ravana	D12/403
D333,646 S *	3/1993	Levy	D12/403
D340,689 S *	10/1993	Wolcott et al.	D12/404

D382,248 S *	8/1997	Long	D12/403
D397,669 S *	9/1998	Komick	D12/403
D421,956 S *	3/2000	Aubut	D12/401
6,170,502 B1 *	1/2001	Pullen	135/88.13
6,604,777 B2 *	8/2003	Neville	296/164
6,712,422 B1 *	3/2004	Vaillancourt	296/165
2001/0048232 A1 *	12/2001	Thompson et al.	296/165
2005/0247747 A1 *	11/2005	Henry et al.	224/401

* cited by examiner

Primary Examiner—Robert M. Spear

Assistant Examiner—George D Kirschbaum

(74) *Attorney, Agent, or Firm*—Marsh Fischmann & Breyfogle LLP

(57) **CLAIM**

An expedition vehicle, as shown and described.

DESCRIPTION

FIG. 1 is a perspective view of an expedition vehicle showing our new design in an open configuration;

FIG. 2 is a front view thereof

FIG. 3 is a back view thereof;

FIG. 4 is a side view thereof;

FIG. 5 is a top view thereof;

FIG. 6 is a perspective view of the expedition vehicle of FIG. 1 shown in a closed configuration;

FIG. 7 is a front view thereof;

FIG. 8 is a back view thereof;

FIG. 9 is a side view thereof; and,

FIG. 10 is a top view thereof.

In the drawings, the broken line showing of a vehicle depicts environmental subject matter and forms no part of the claim.

1 Claim, 10 Drawing Sheets

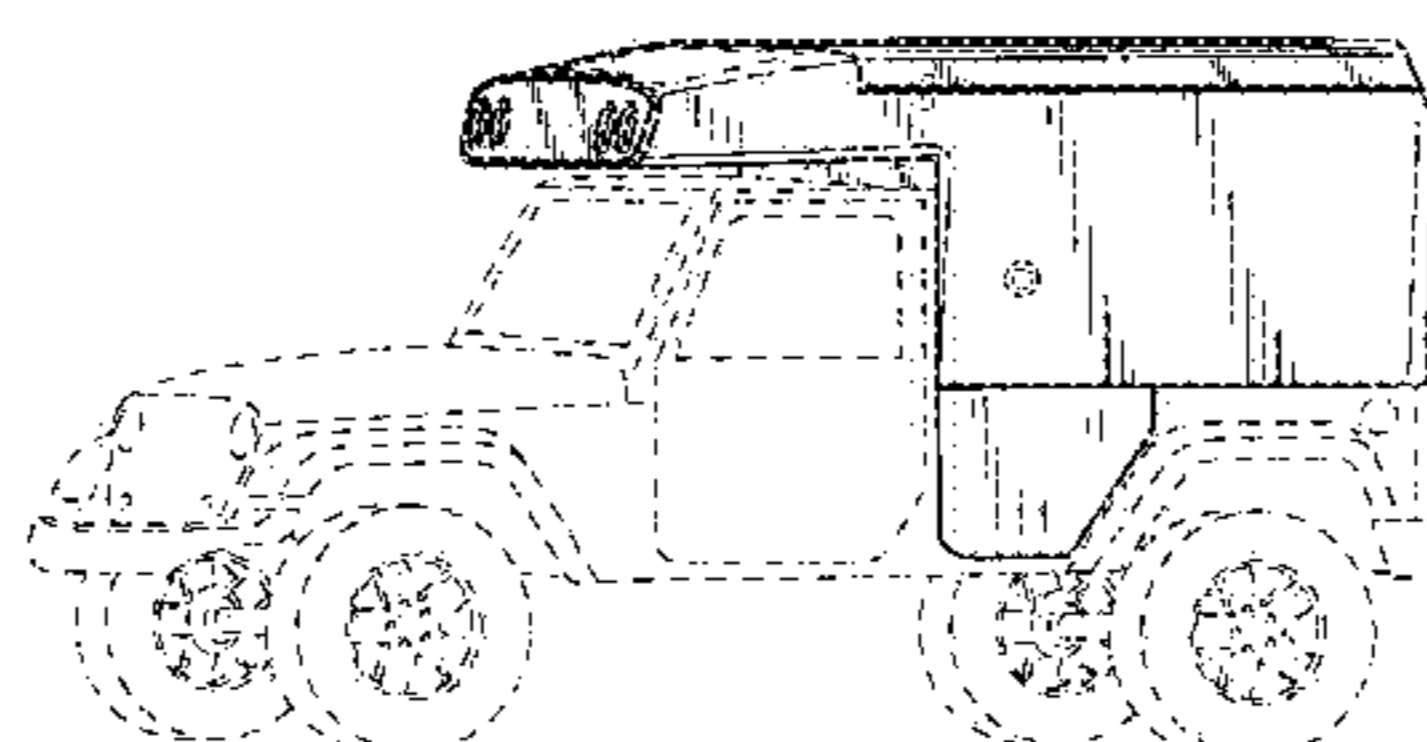
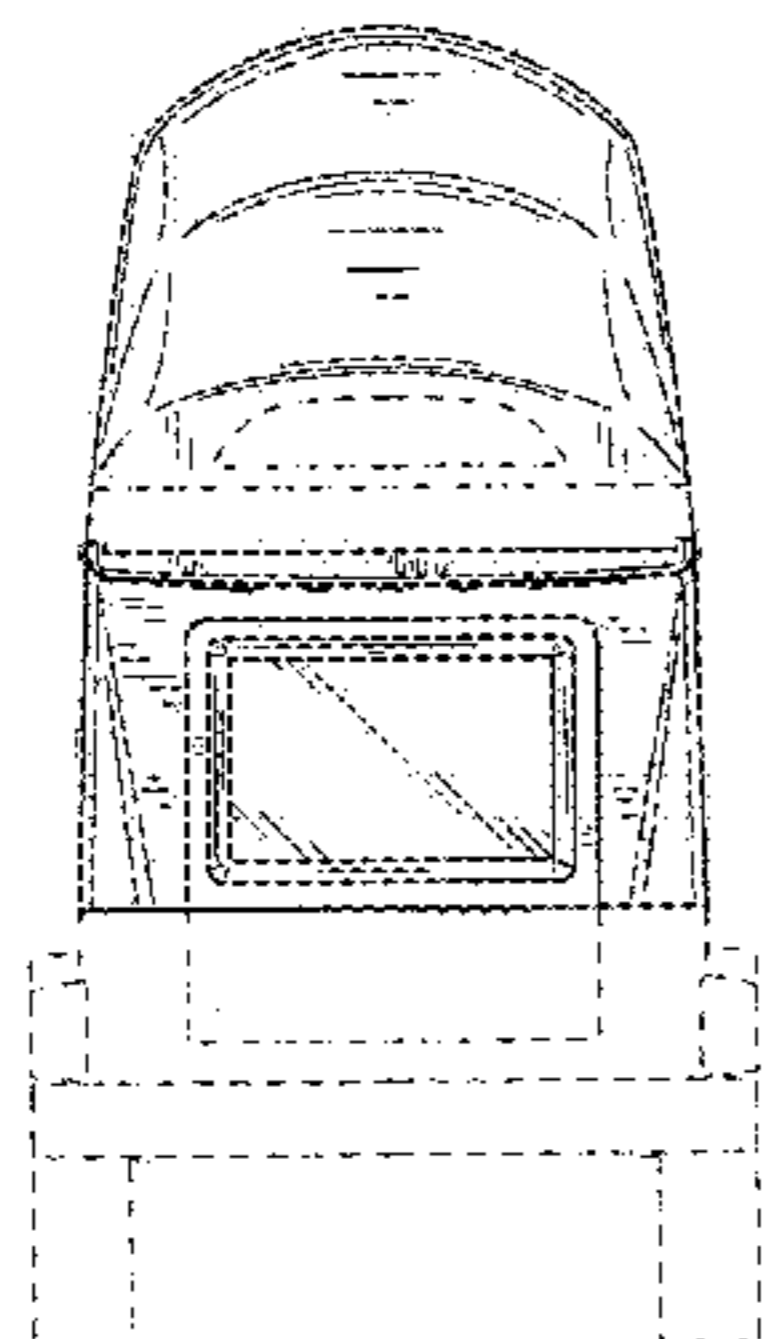
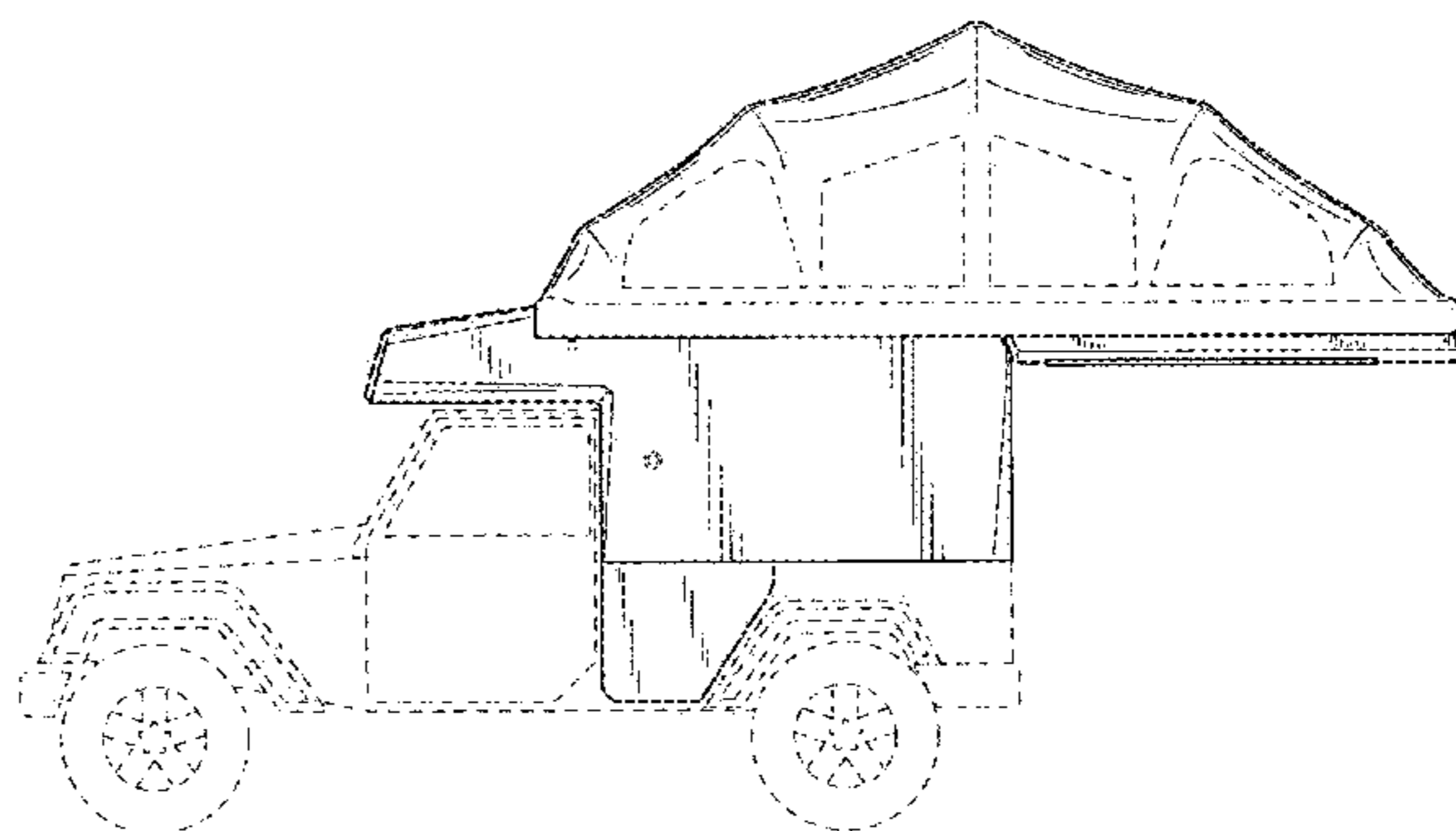
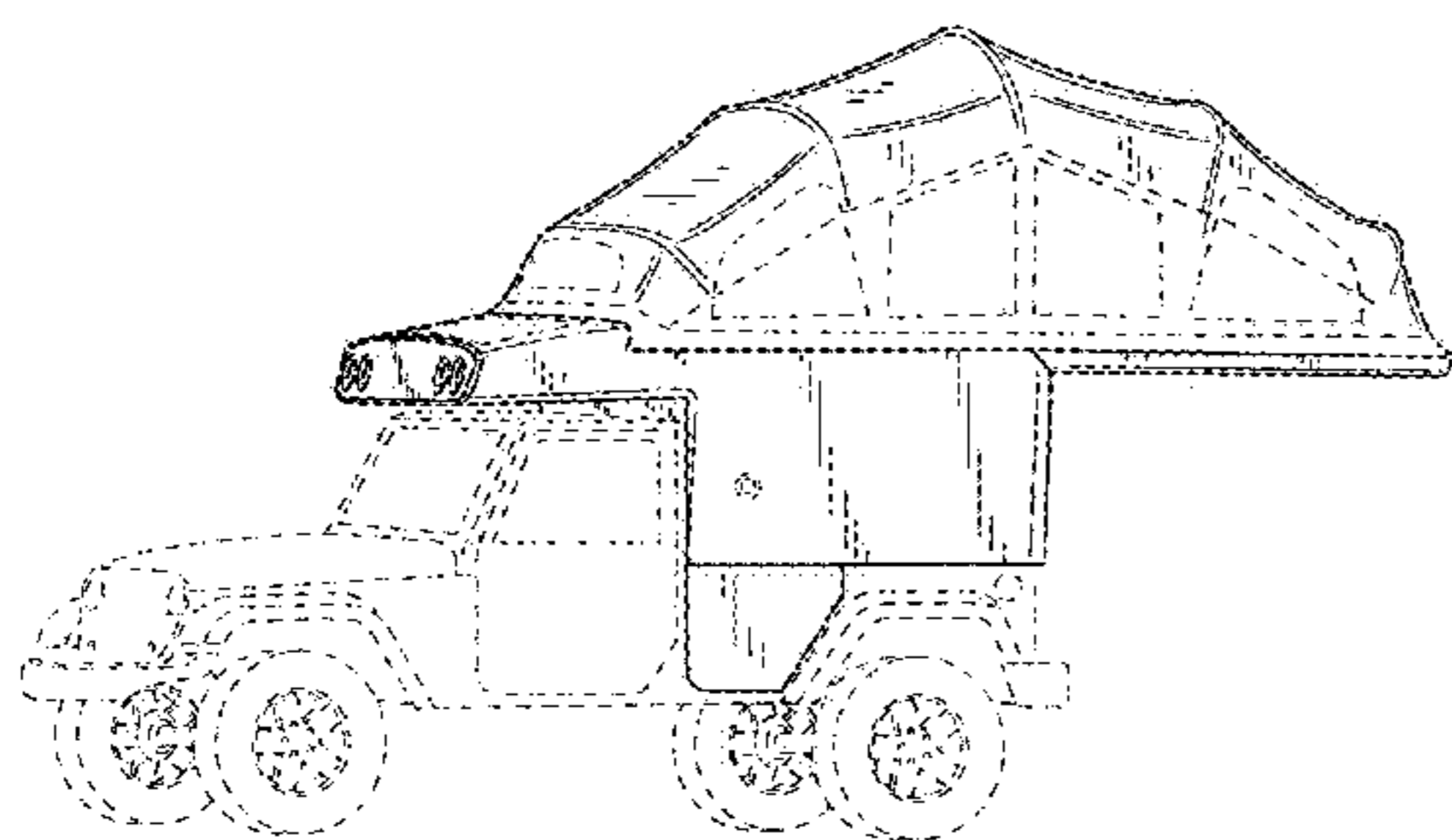

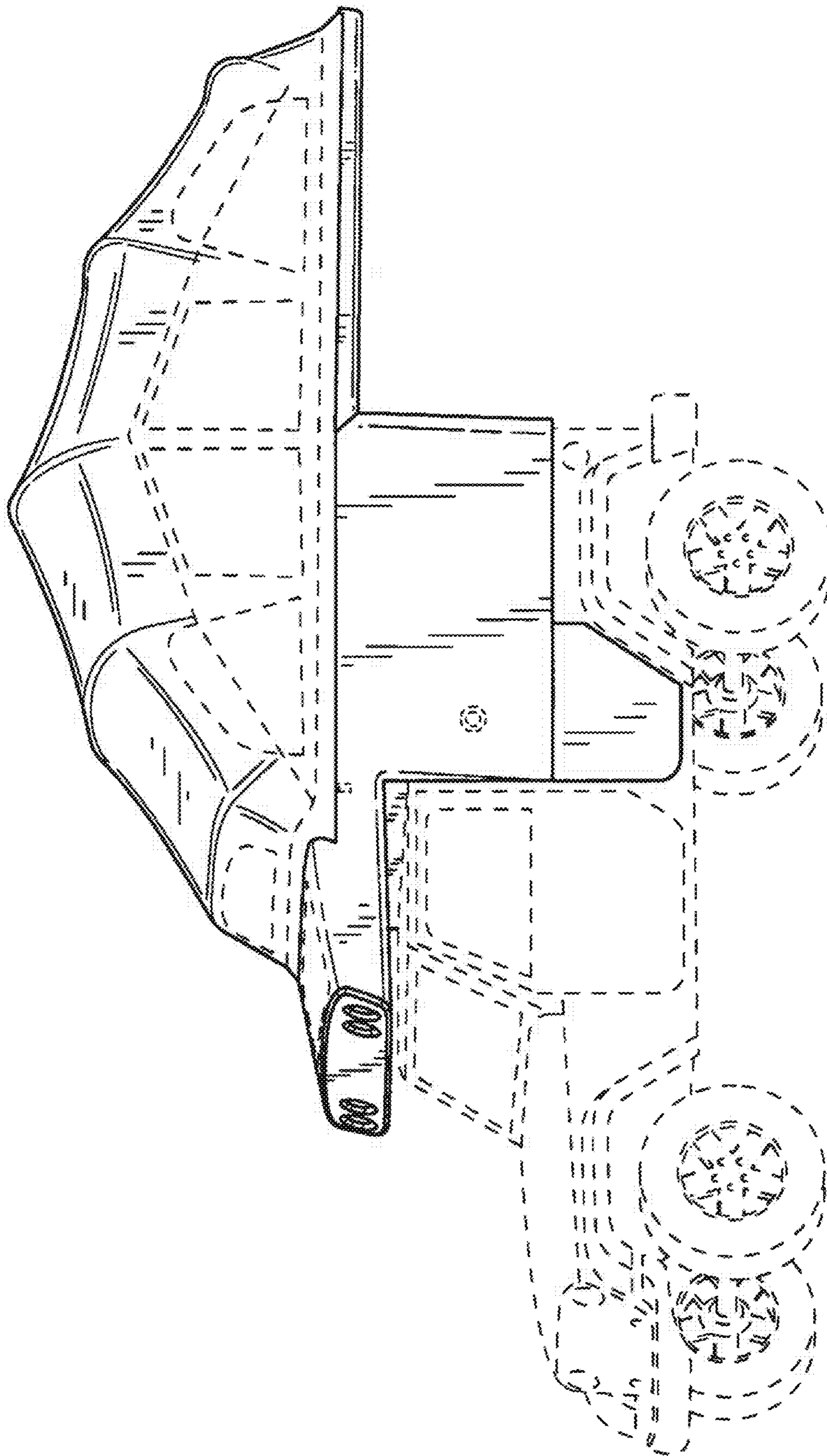

FIG.1

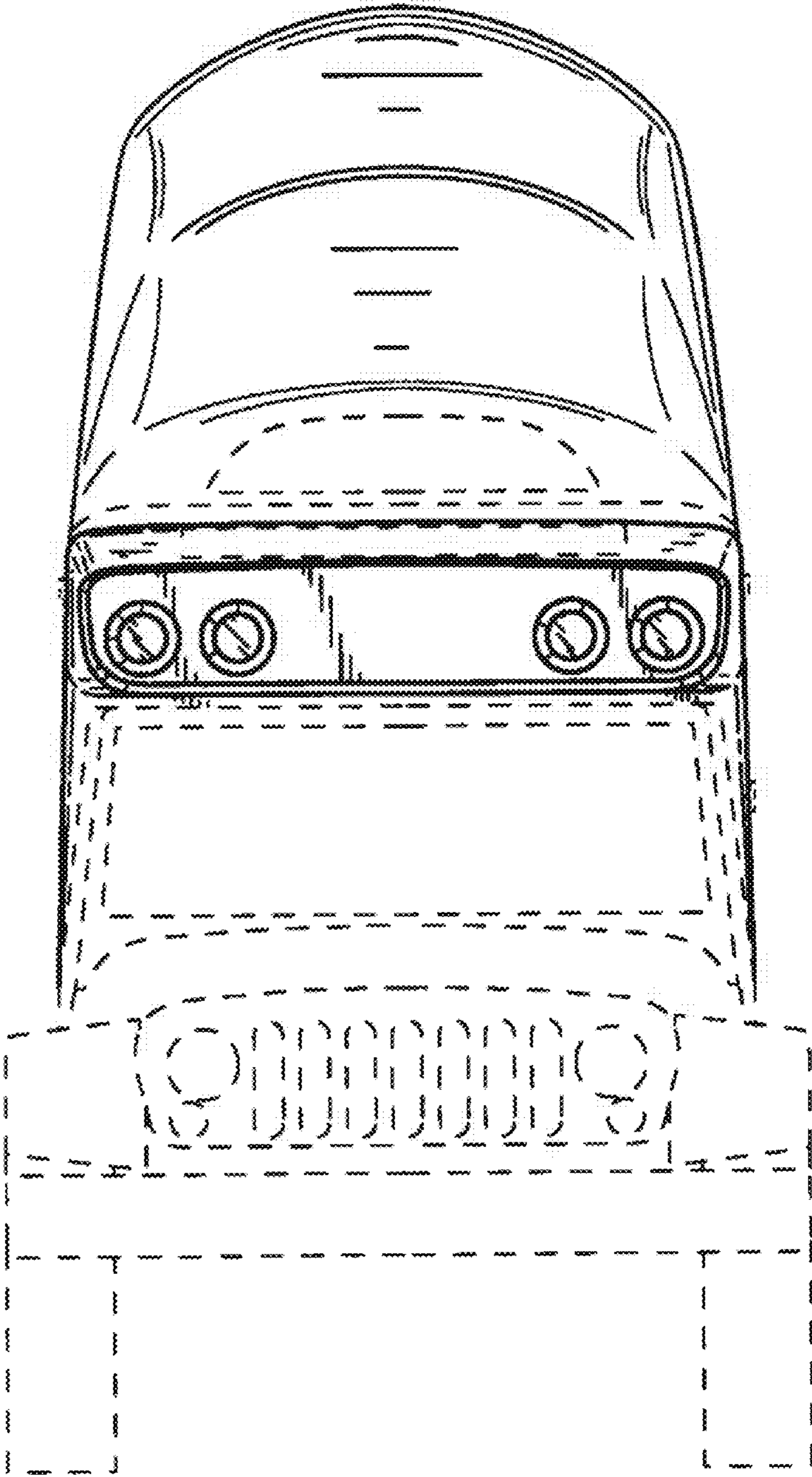

FIG.2

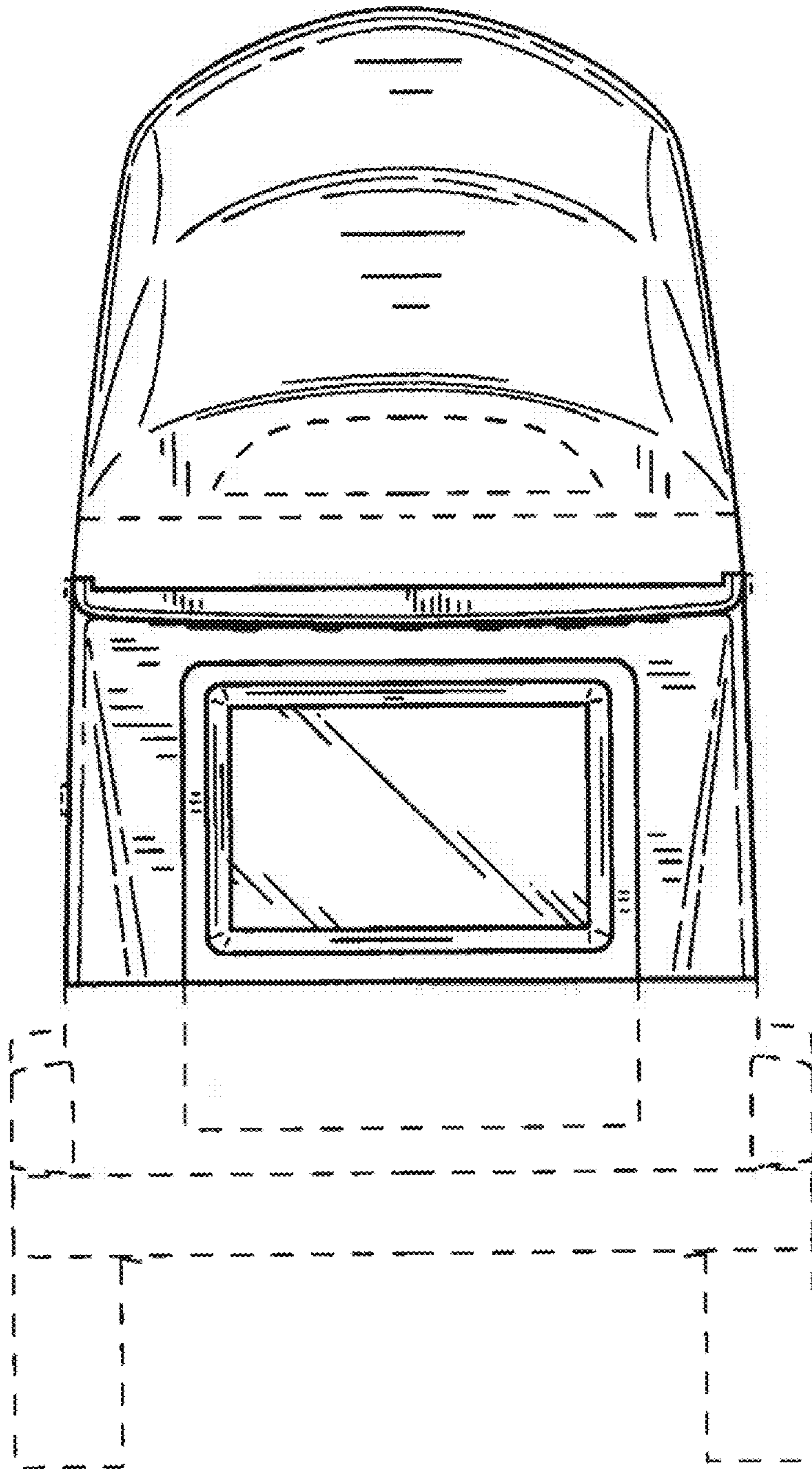

FIG.3

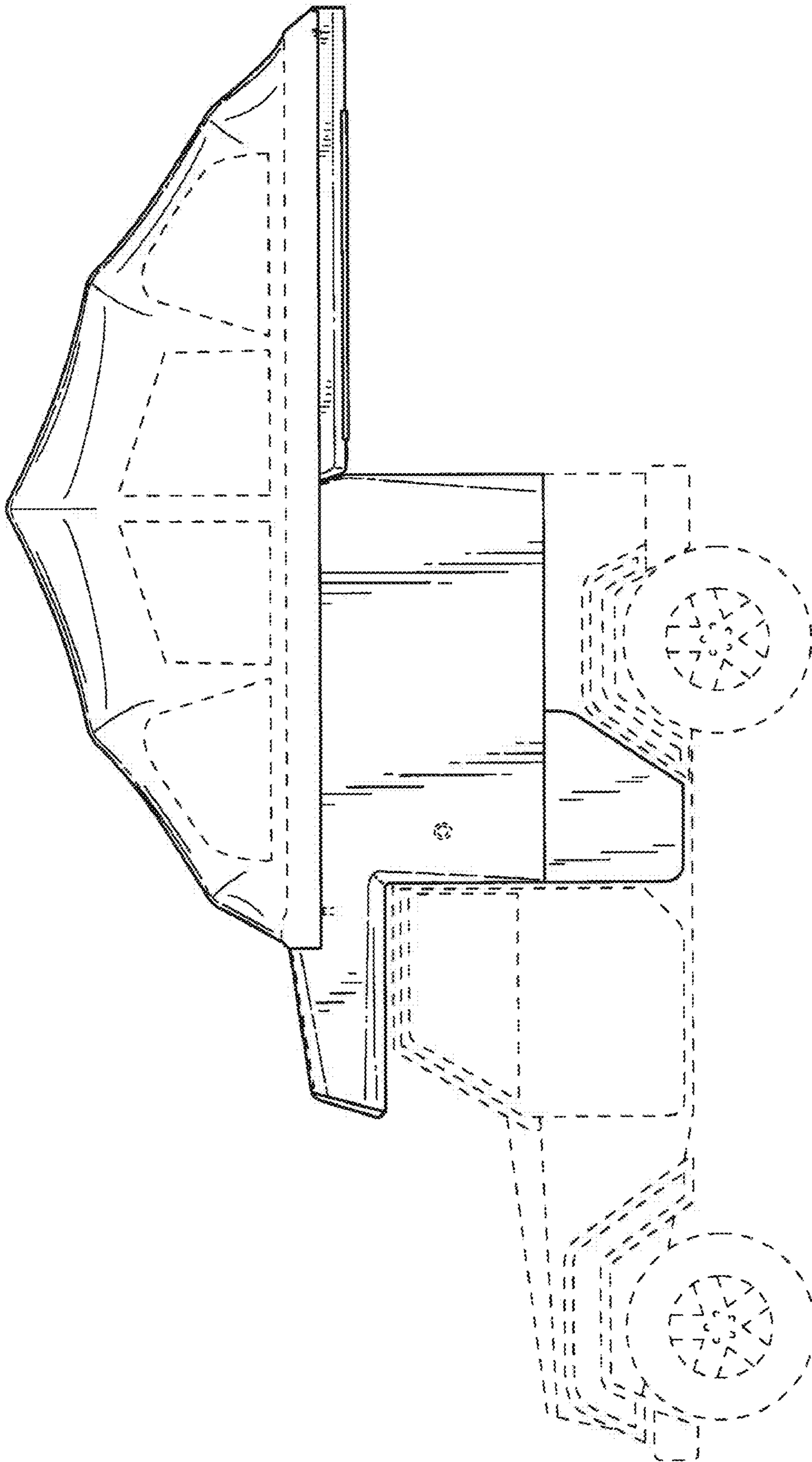

FIG. 4

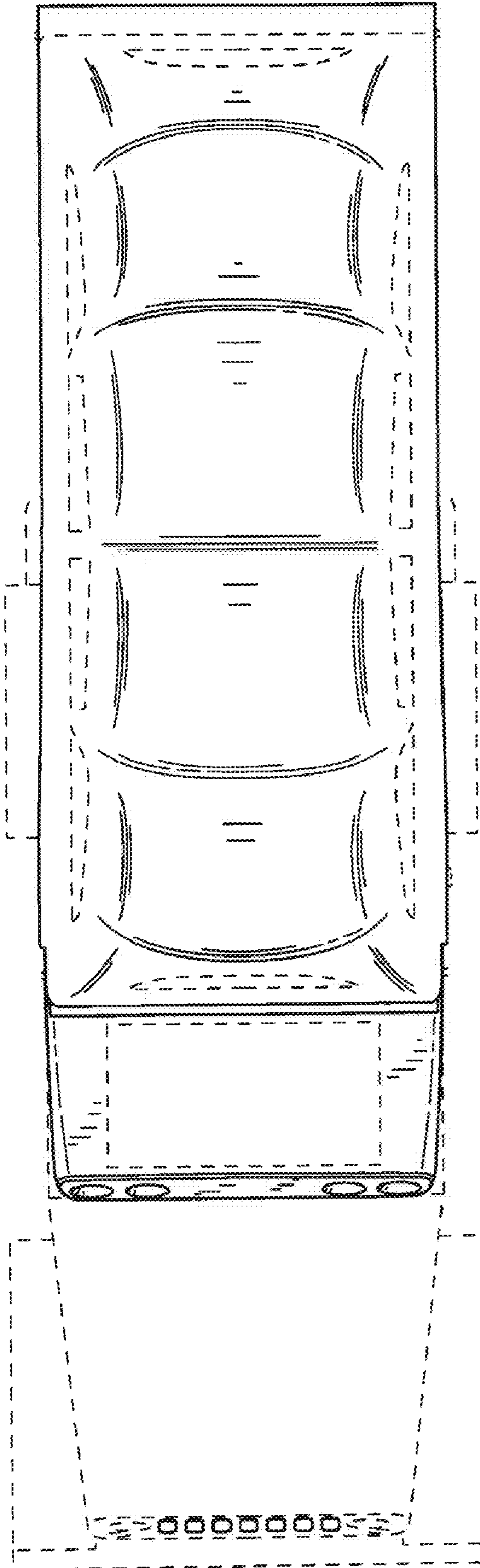

FIG.5

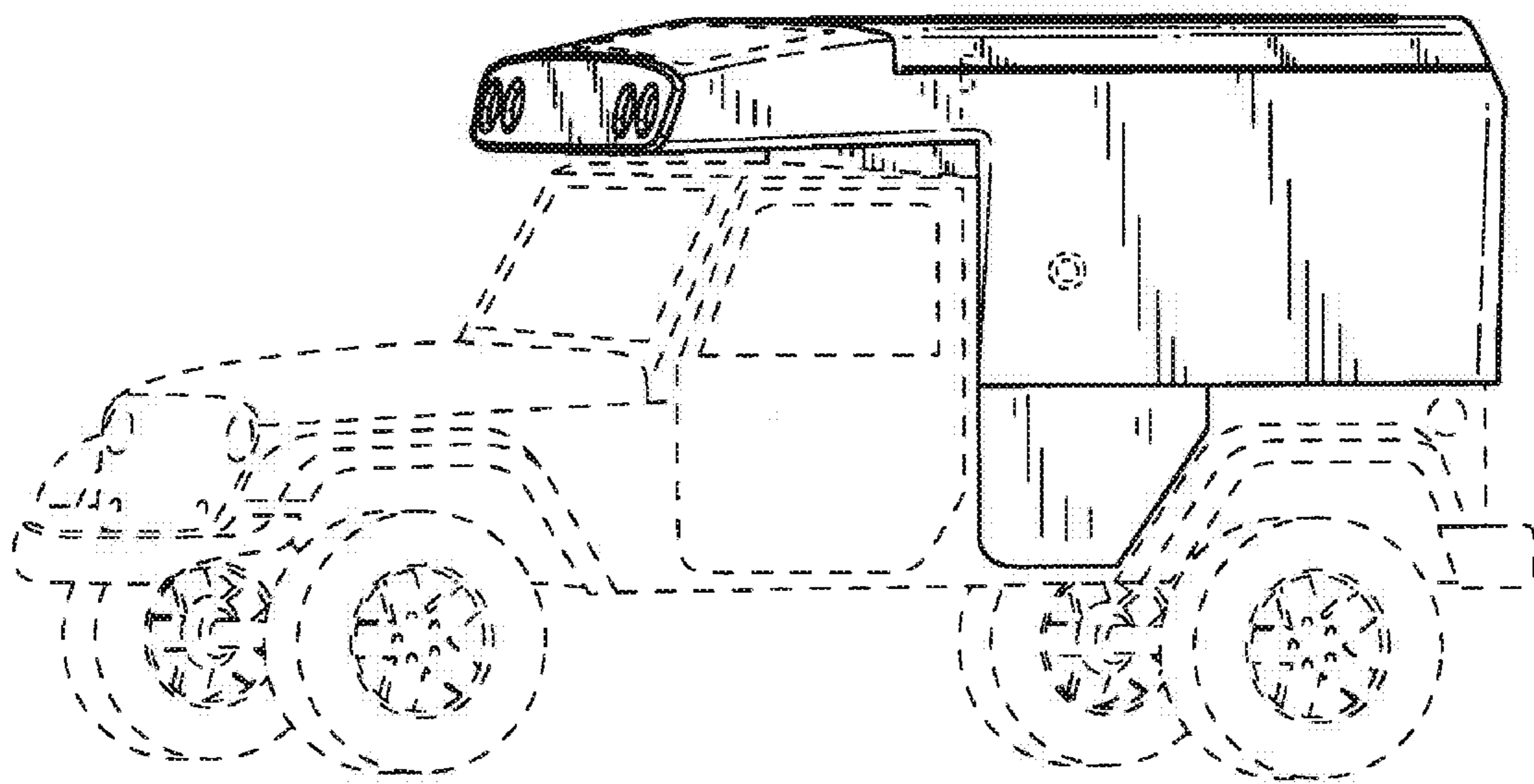

FIG.6

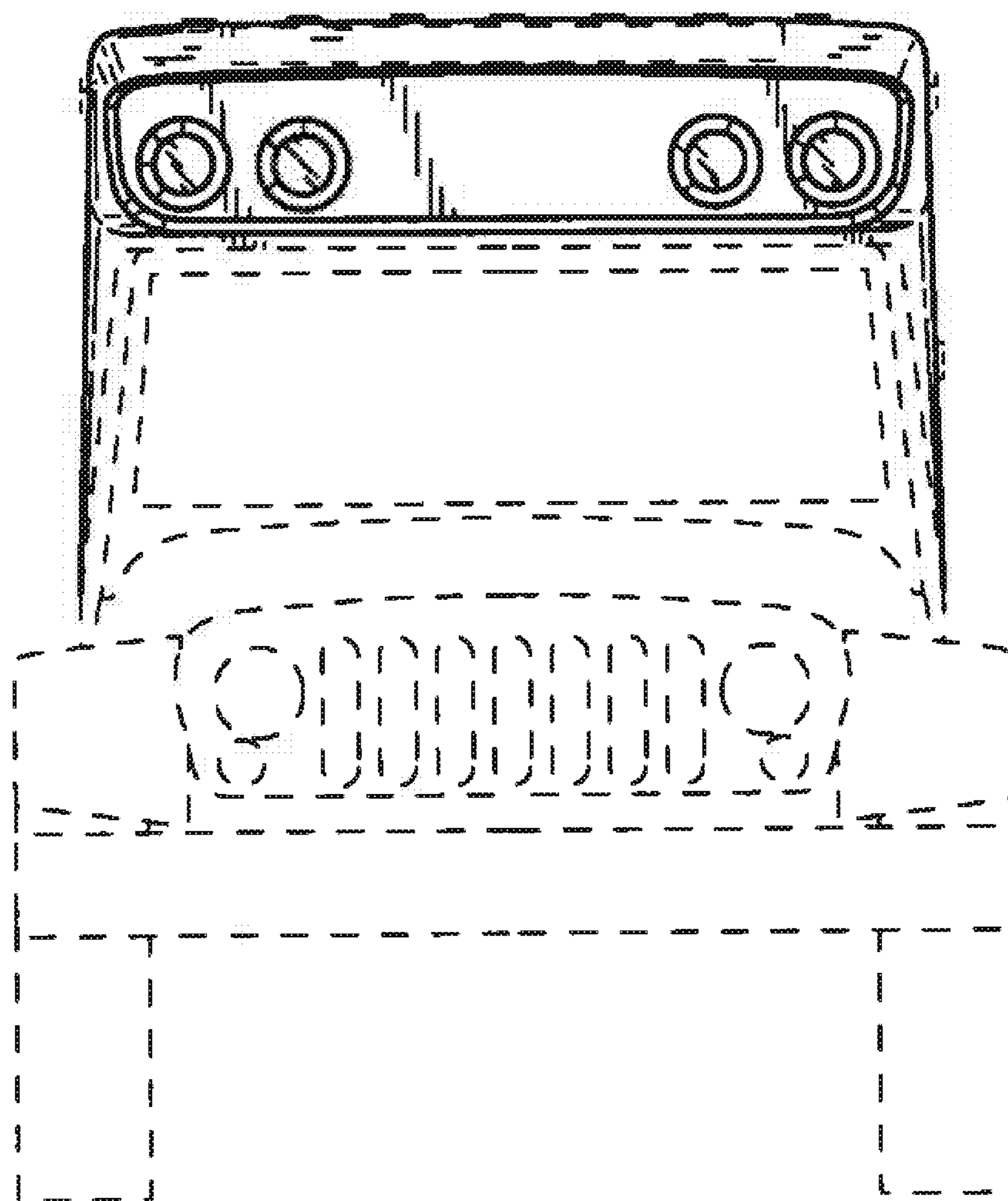

FIG.7

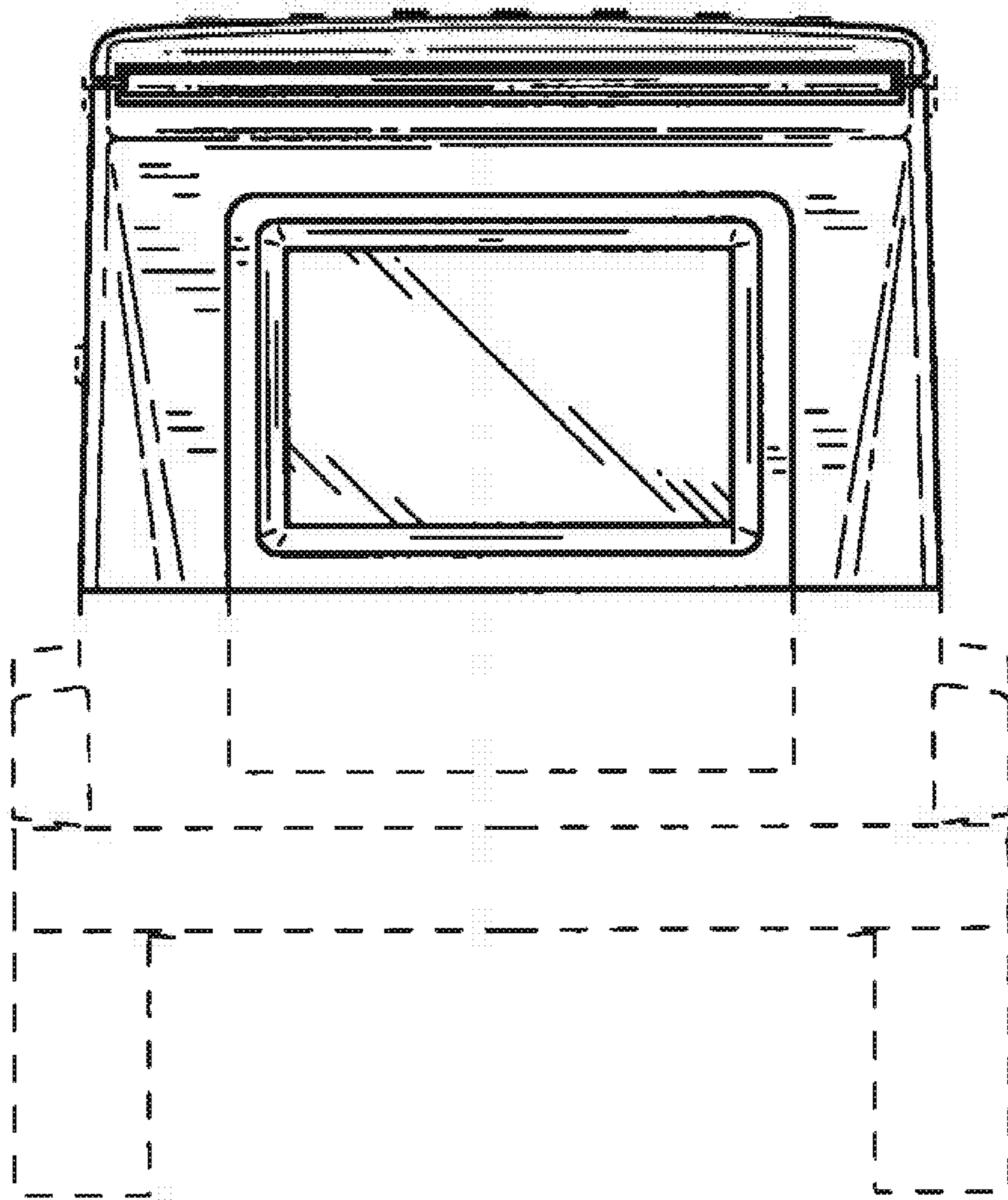

FIG.8

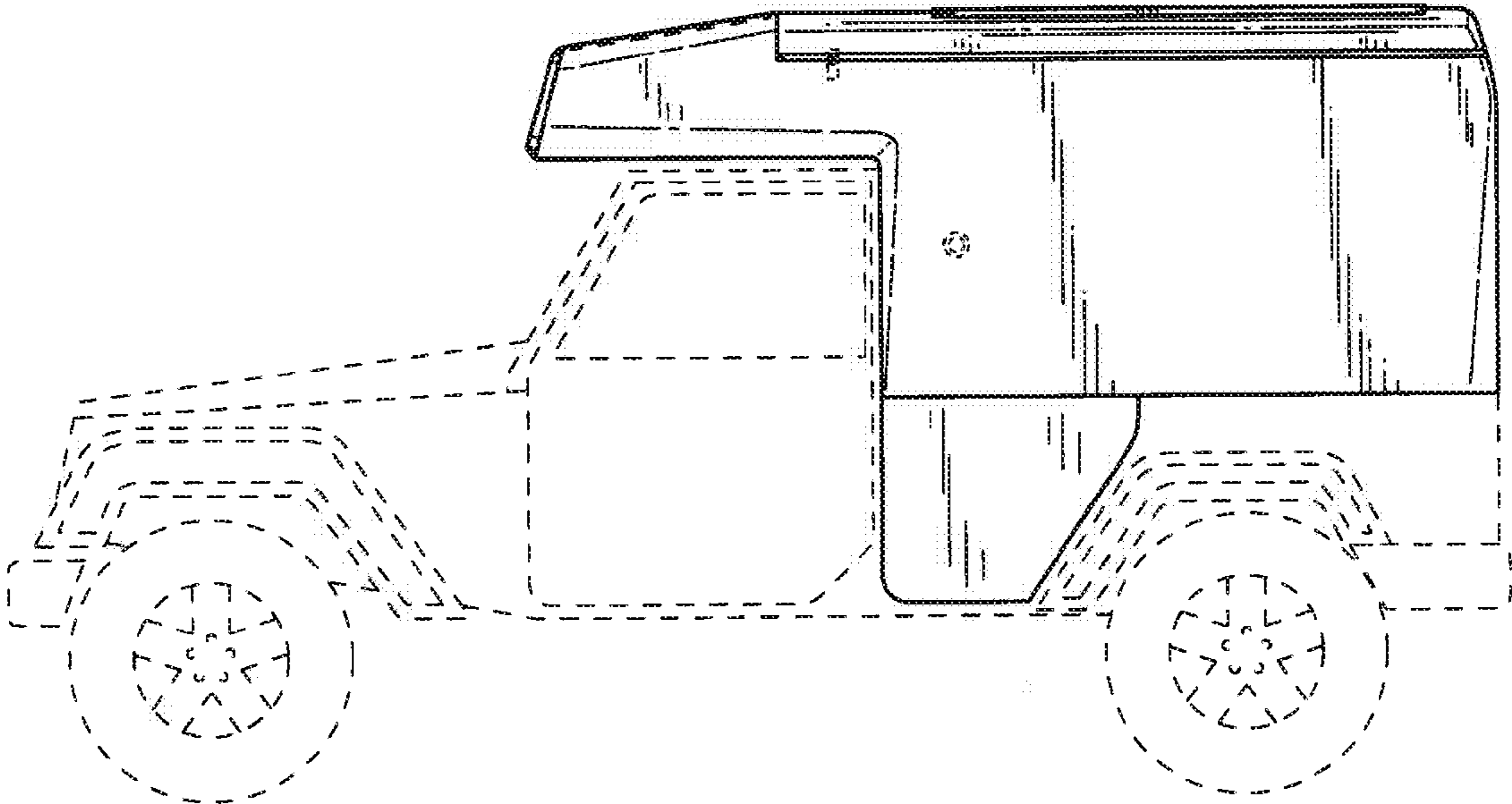

FIG.9

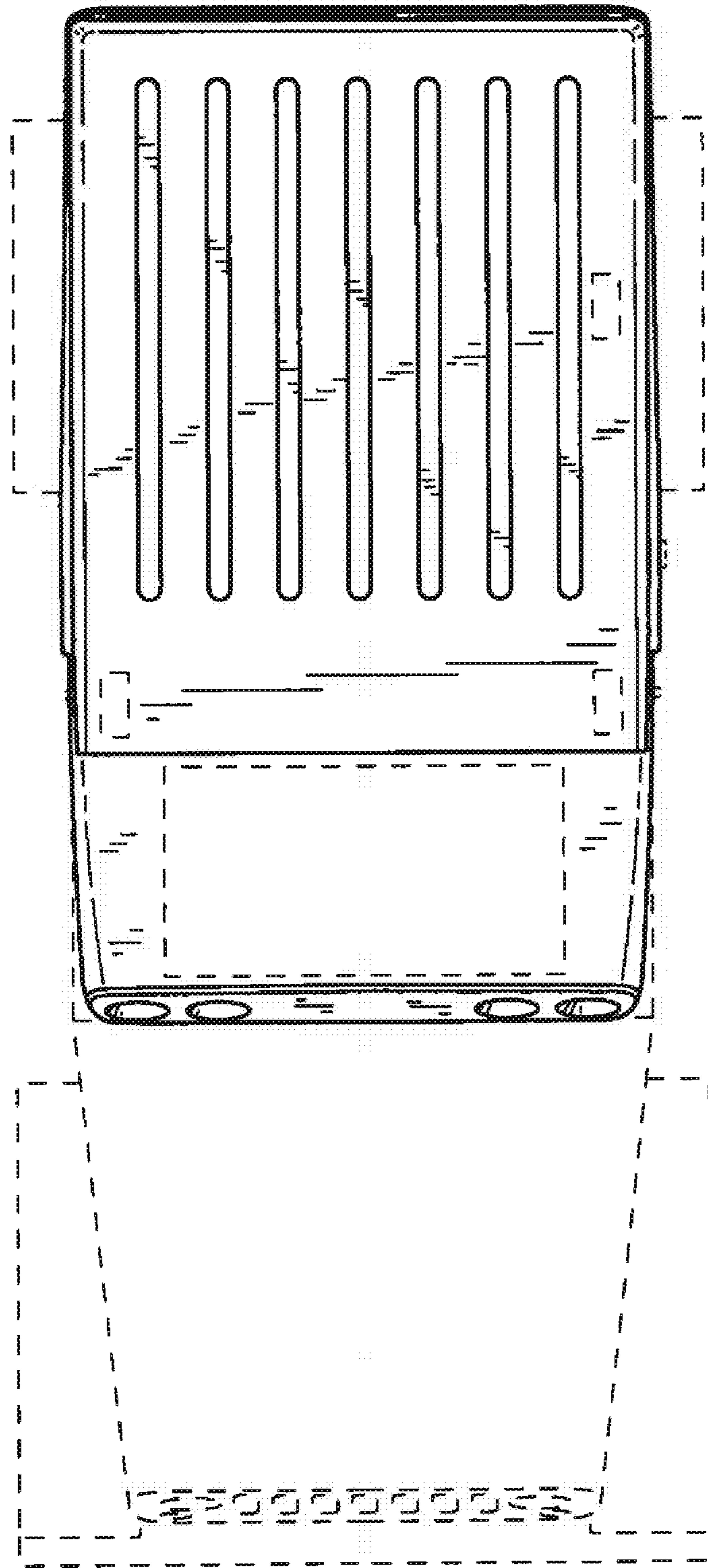

FIG. 10