



US00D573977S

(12) **United States Design Patent**  
**Ledbetter et al.**

(10) **Patent No.:** **US D573,977 S**  
(45) **Date of Patent:** **\*\* Jul. 29, 2008**

(54) **PAIR OF EAR PHONES**

(75) Inventors: **Carl J. Ledbetter**, Mercer Island, WA (US); **John Ikeda**, Seattle, WA (US); **Saro Nalbandian**, Athens (GR)

(73) Assignee: **Microsoft Corporation**, Redmond, WA (US)

(\*\*) Term: **14 Years**

(21) Appl. No.: **29/283,836**

(22) Filed: **Aug. 24, 2007**

(51) **LOC (8) Cl.** ..... **14-01**

(52) **U.S. Cl.** ..... **D14/205**

(58) **Field of Classification Search** ..... D14/205–206, D14/223, 142, 168, 188, 192, 249; 181/129–130, 181/135; 379/430, 431, 420, 420.04, 420.02; 381/322, 328, 370, 371, 373, 374, 375, 380, 381/381; 455/550.1, 569.1, 575.1  
See application file for complete search history.

(56) **References Cited**

**U.S. PATENT DOCUMENTS**

4,646,872	A *	3/1987	Kamon et al.	181/129
4,965,838	A *	10/1990	Kamon et al.	381/380
5,410,608	A *	4/1995	Lucey et al.	381/360
6,122,369	A *	9/2000	Hwang et al.	379/420.04
D469,753	S *	2/2003	Andre et al.	D14/205
D523,846	S *	6/2006	Lee	D14/205
D554,109	S *	10/2007	Ledbetter et al.	D14/223
D555,152	S *	11/2007	Wang	D14/223
D556,741	S *	12/2007	Yeo et al.	D14/223
D564,495	S *	3/2008	Sasaki	D14/205
D566,687	S *	4/2008	Duarte et al.	D14/205

D568,291 S \* 5/2008 Andre et al. .... D14/205

\* cited by examiner

*Primary Examiner*—Paula A Greene

(74) *Attorney, Agent, or Firm*—Banner & Witcoff, Ltd.

(57) **CLAIM**

The ornamental design for a pair of ear phones, as shown and described.

**DESCRIPTION**

FIG. 1 is a front perspective view of a pair of ear phones showing our new design;

FIG. 2 is a front view thereof;

FIG. 3 is a rear view thereof;

FIG. 4 is a side view thereof of an ear phone in FIG. 1;

FIG. 5 is an opposite side view thereof;

FIG. 6 is a top view thereof of the ear phones in FIG. 1; and

FIG. 7 is a bottom view thereof;

FIG. 8 is a front perspective view of ear phones showing an alternative embodiment of our new design;

FIG. 9 is a front view thereof;

FIG. 10 is a rear view thereof;

FIG. 11 is a side view thereof of an ear phone in FIG. 8;

FIG. 12 is an opposite side view thereof;

FIG. 13 is a top view thereof of the ear phones in FIG. 8; and,

FIG. 14 is a bottom view thereof.

The broken line showing of various regions in the Figures, including the unshaded areas therein, is for illustrative purposes only and forms no part of the claimed design.

**1 Claim, 6 Drawing Sheets**

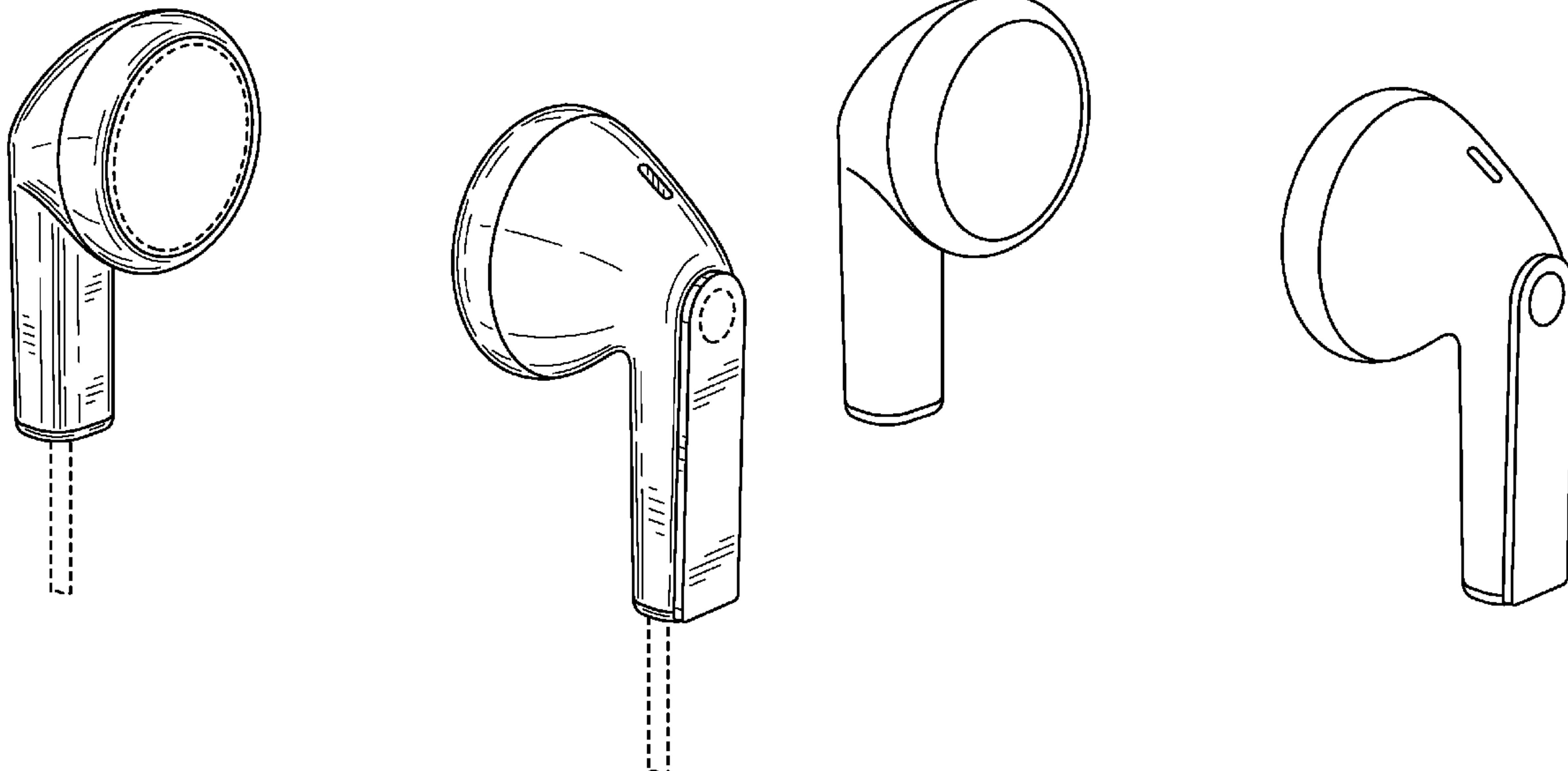

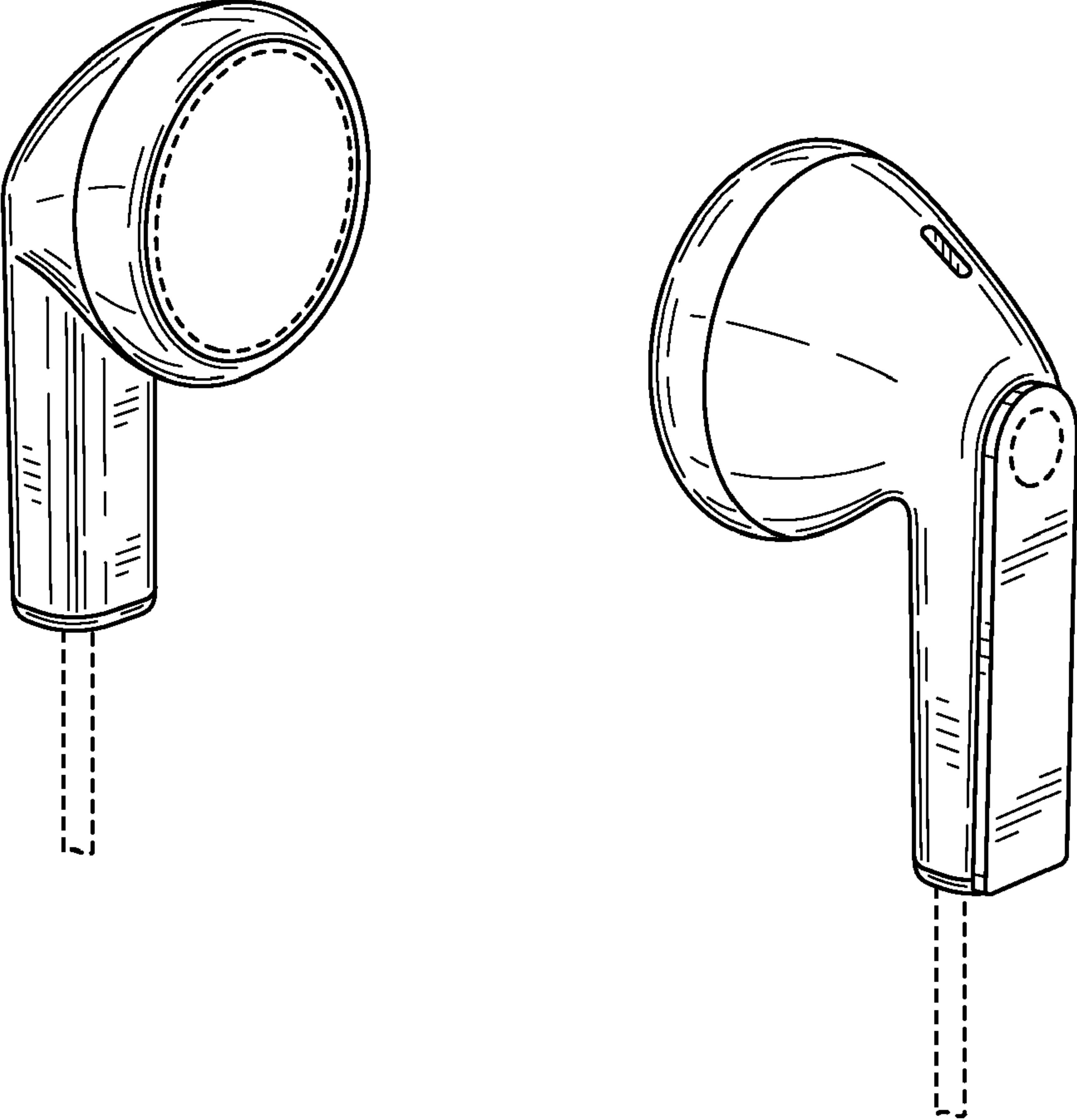

FIG. 1

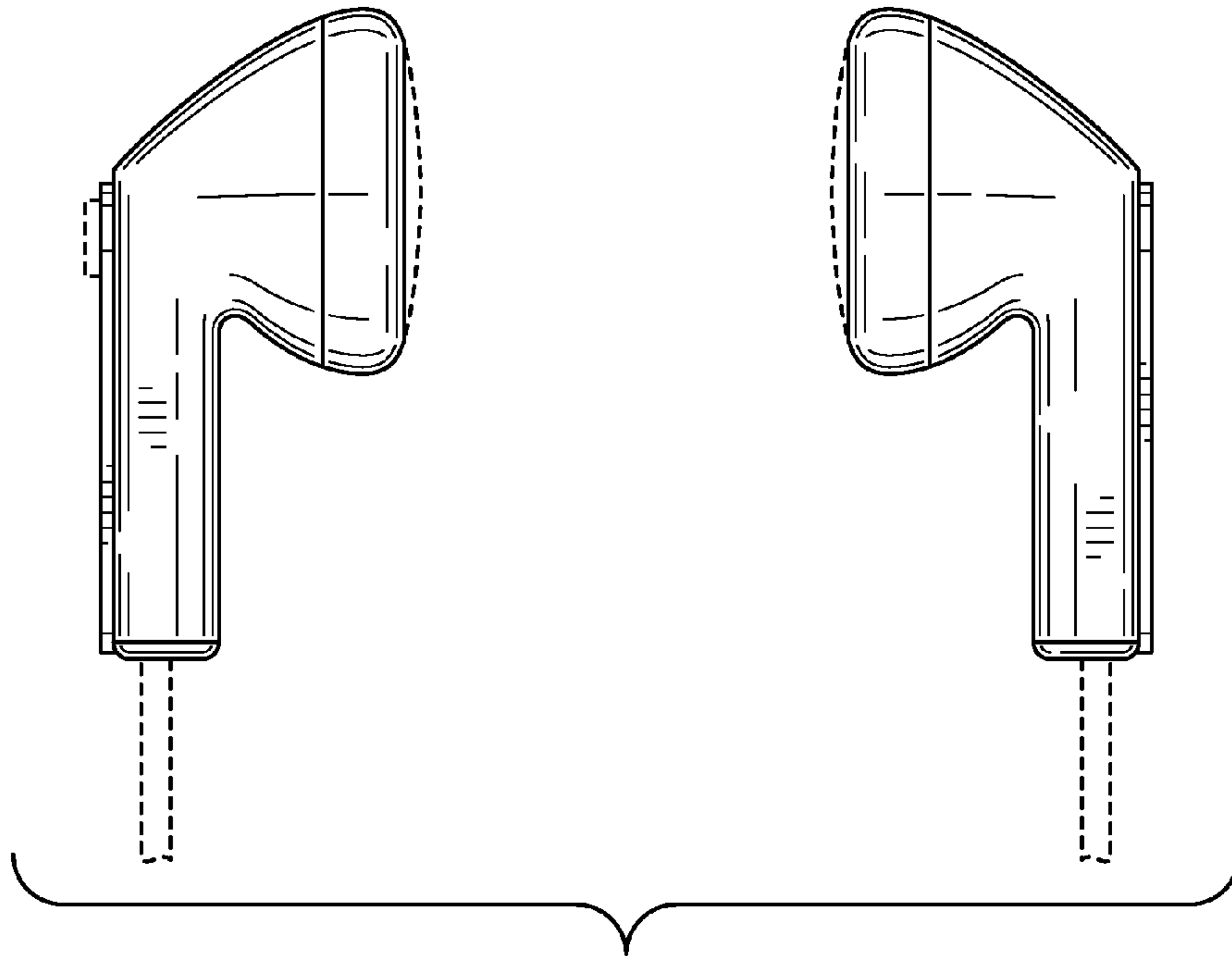

FIG. 2

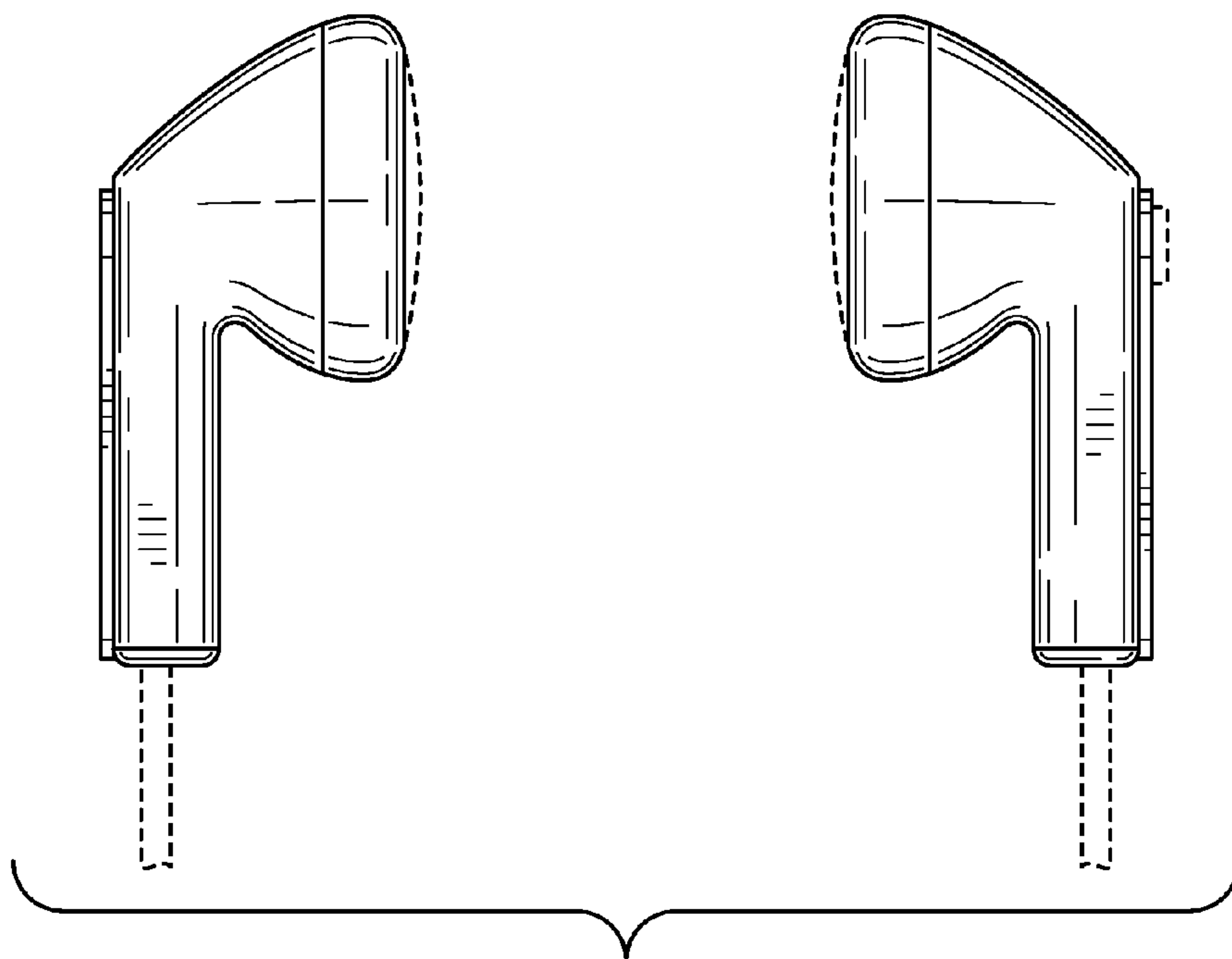

FIG. 3

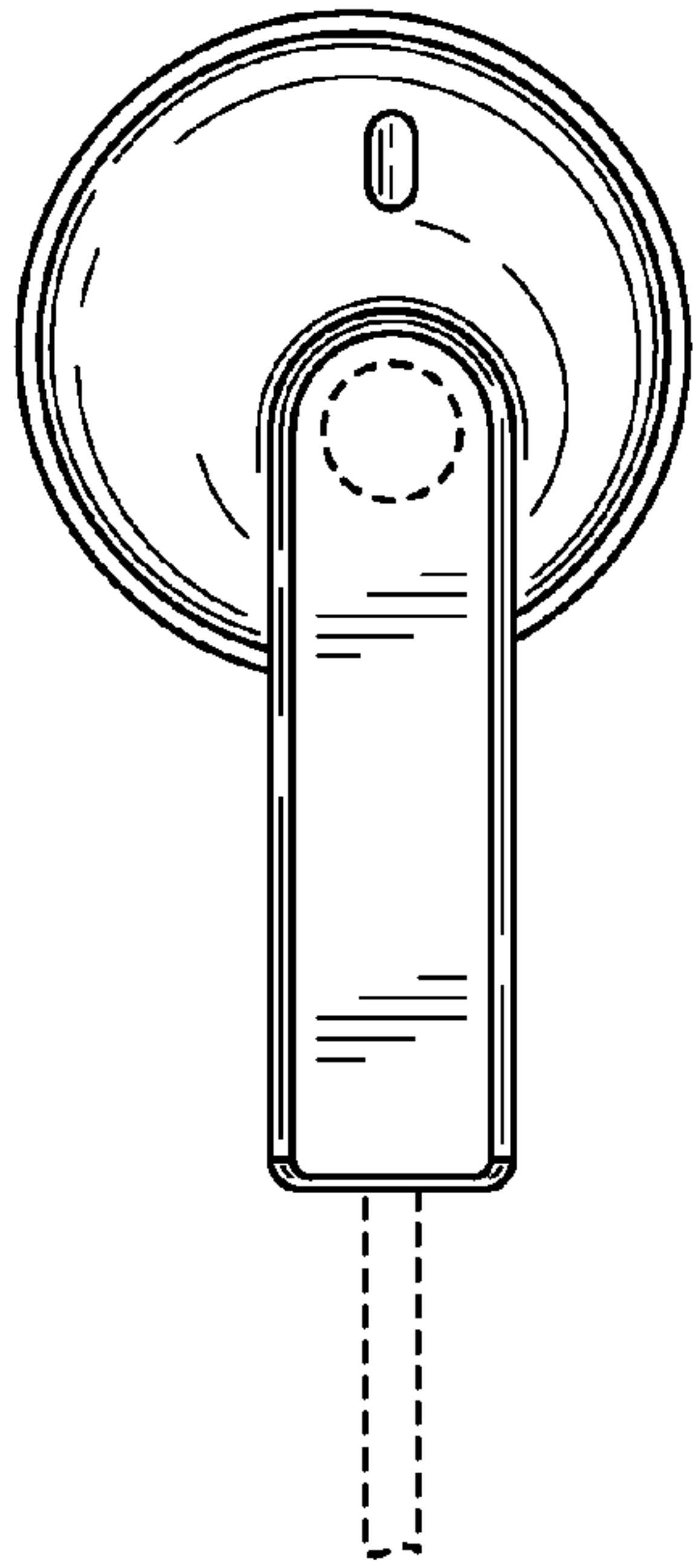

FIG. 4

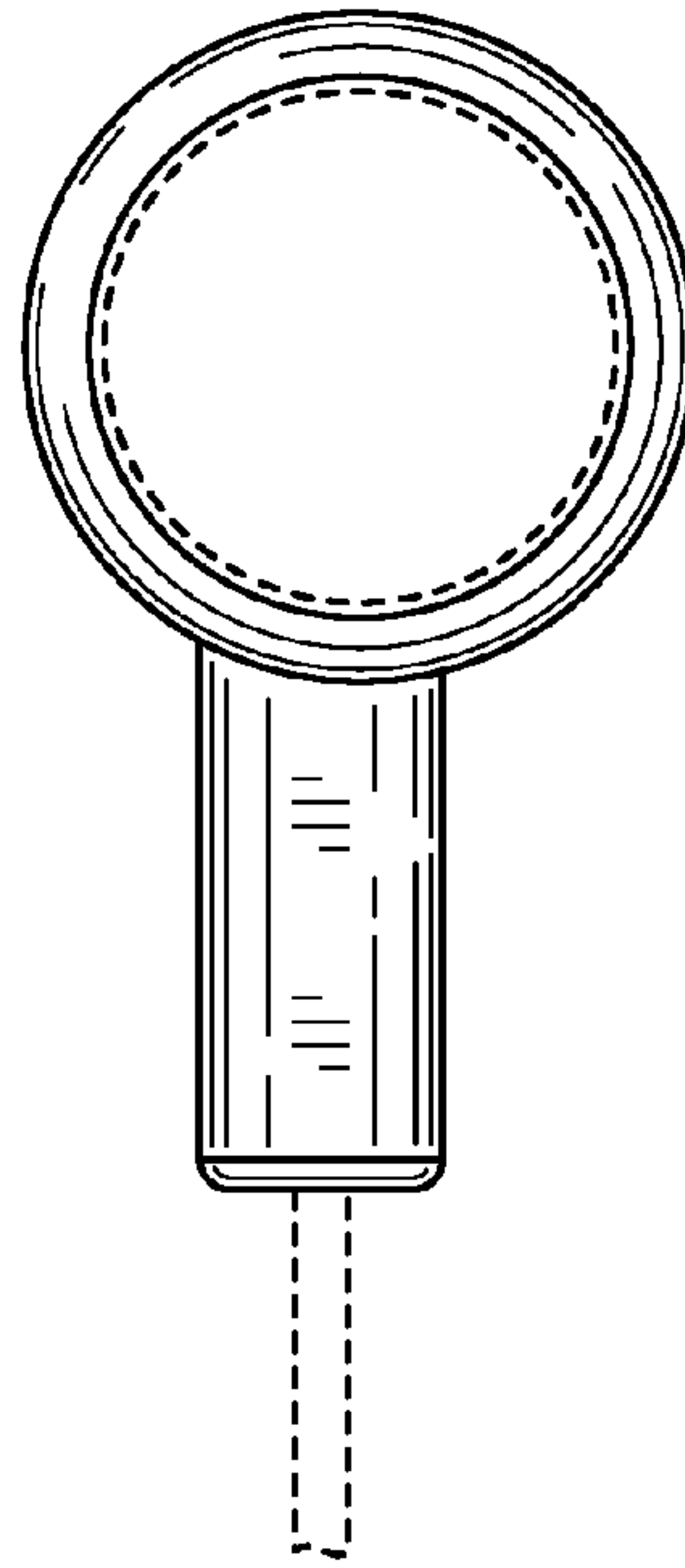

FIG. 5

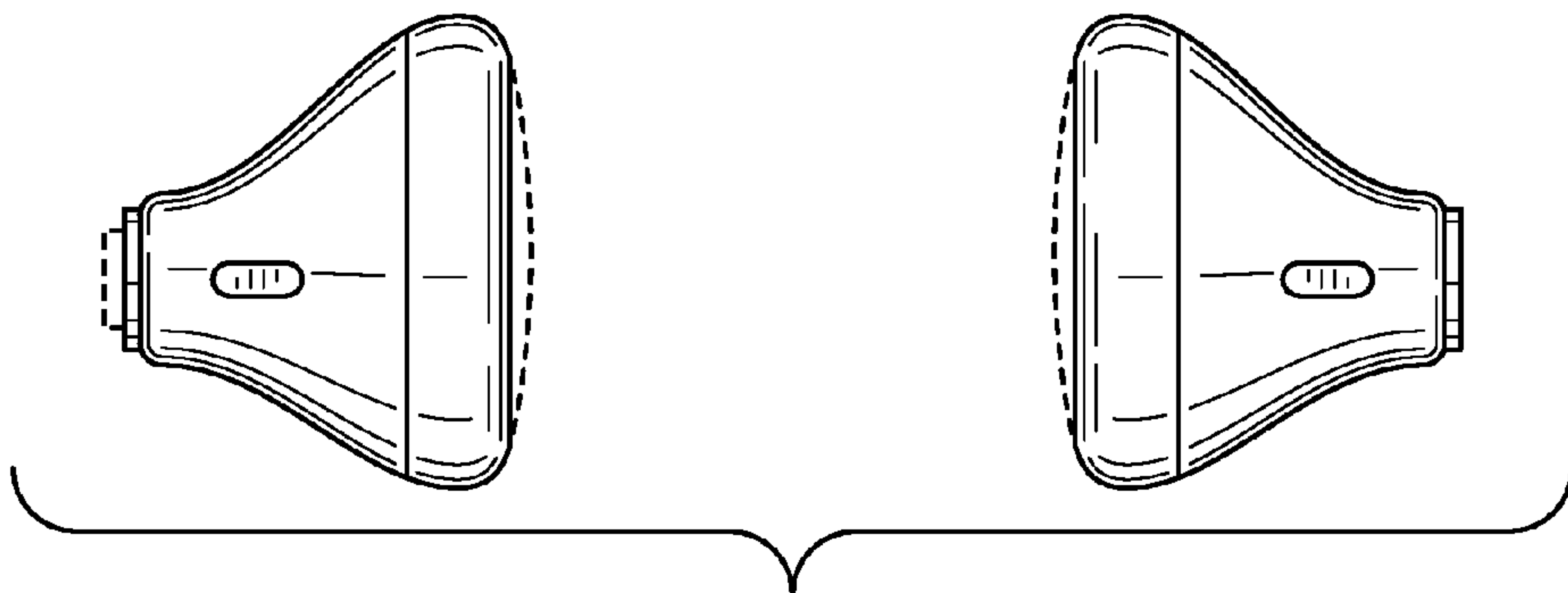

FIG. 6

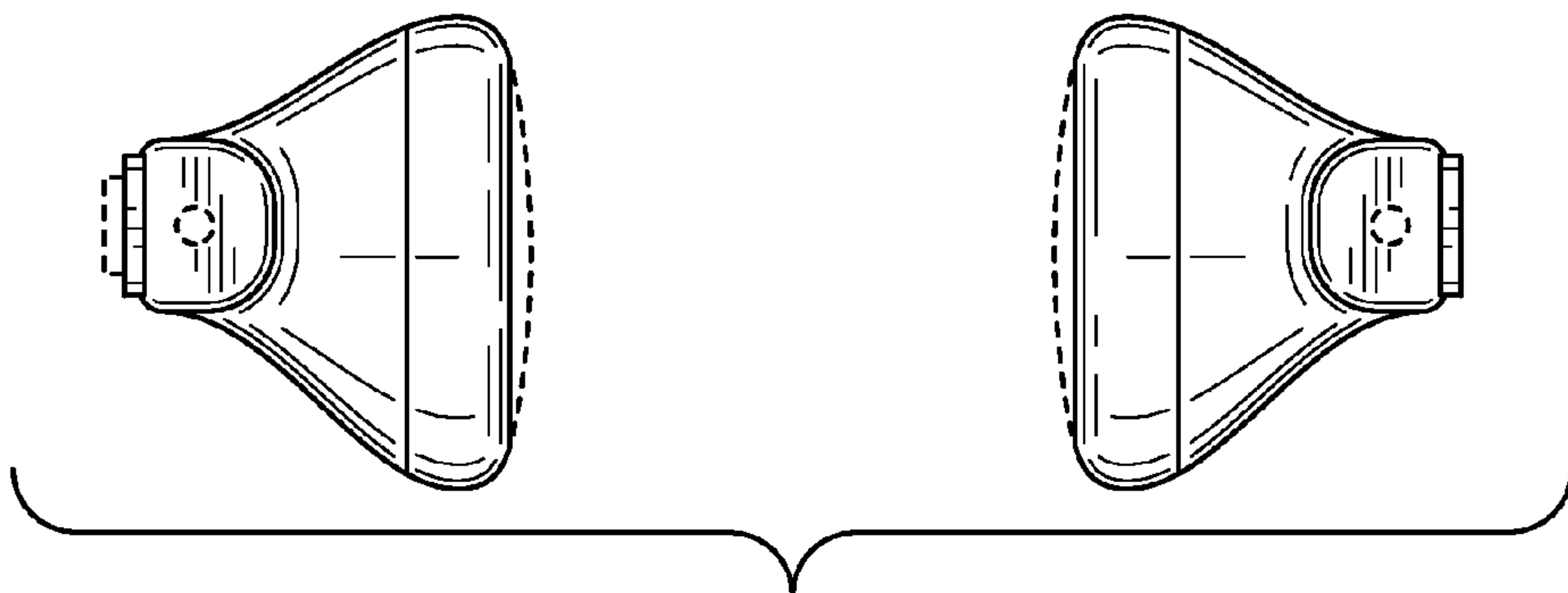

FIG. 7

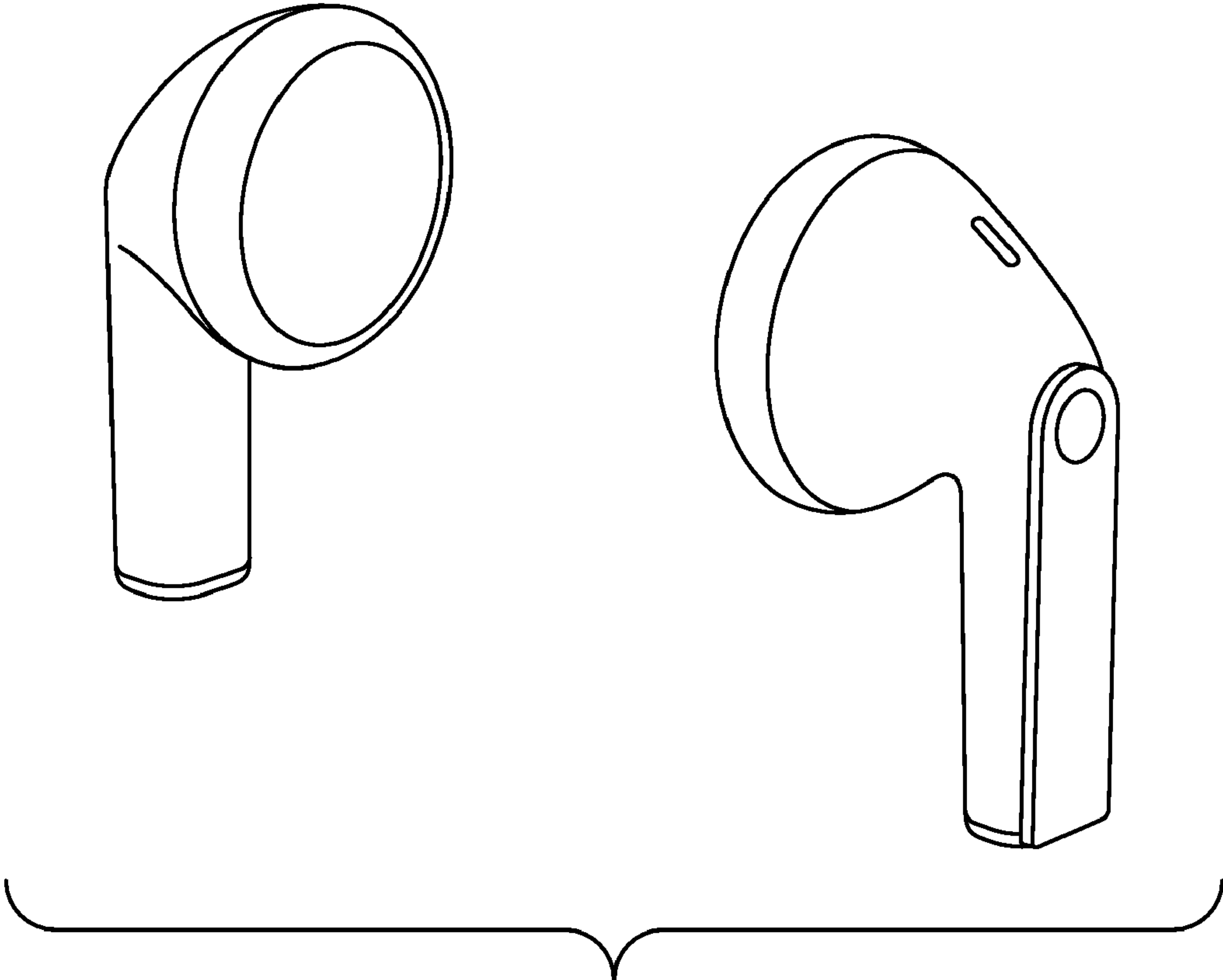

FIG. 8

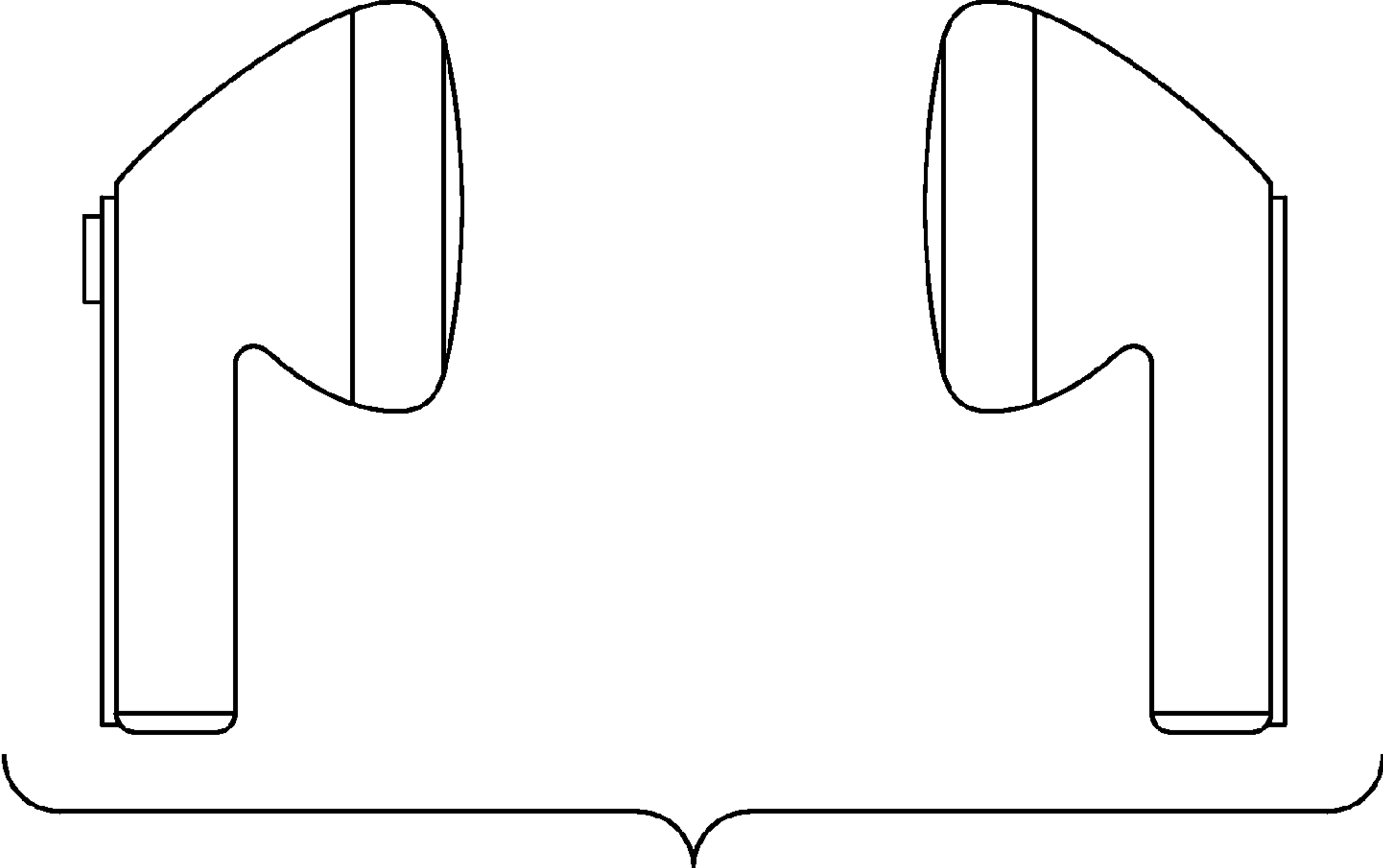

FIG. 9

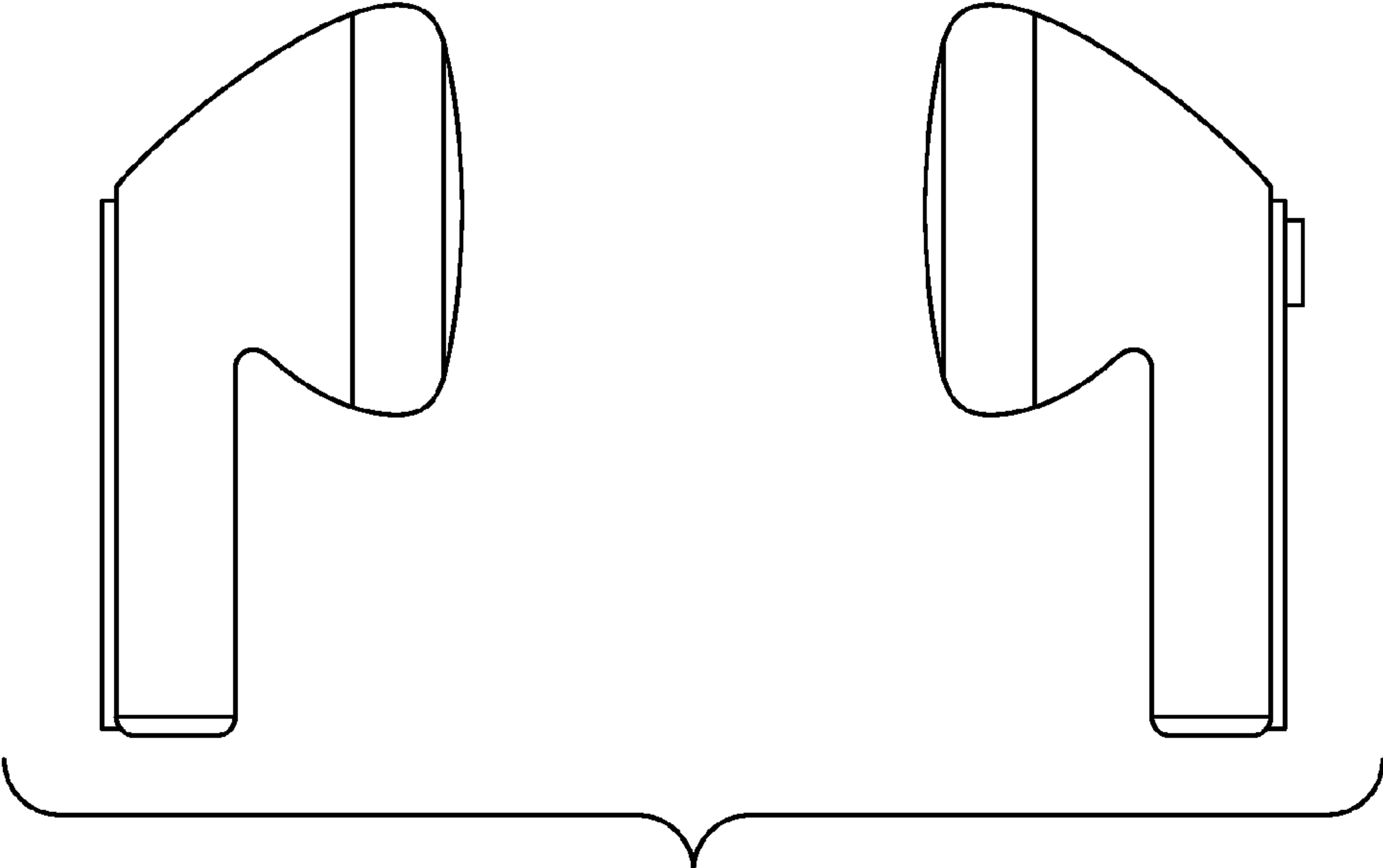

FIG. 10

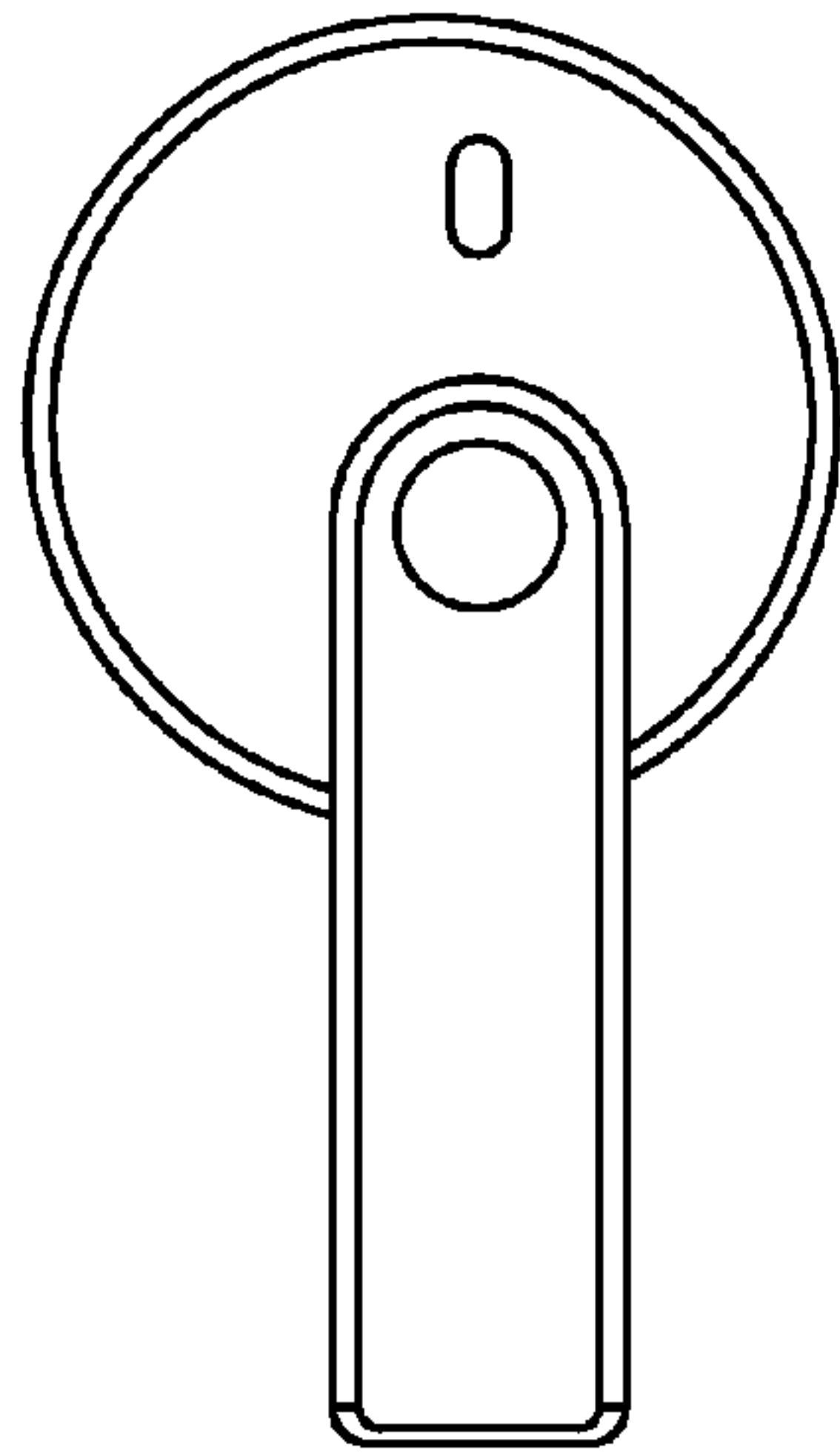

FIG. 11

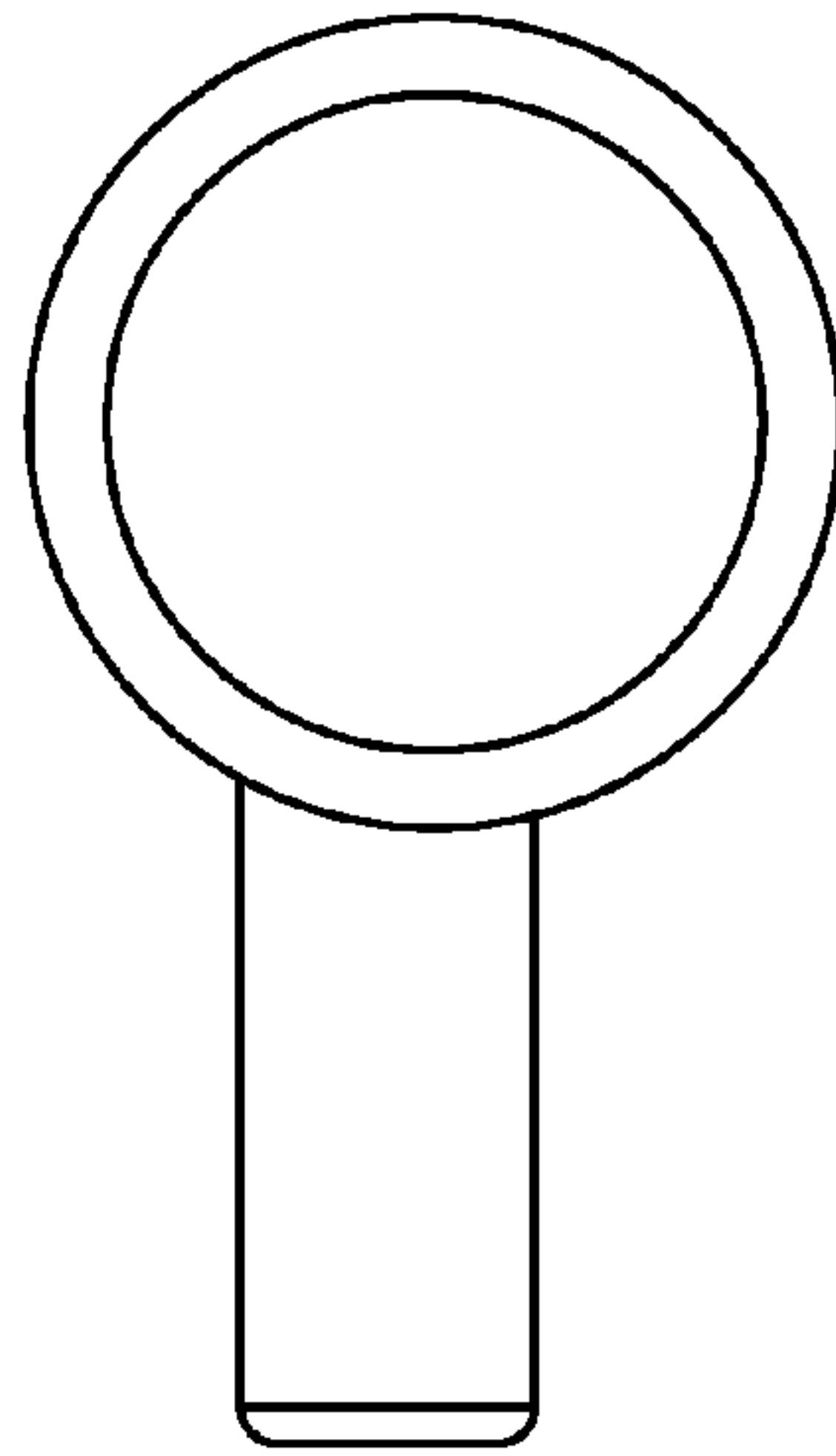

FIG. 12

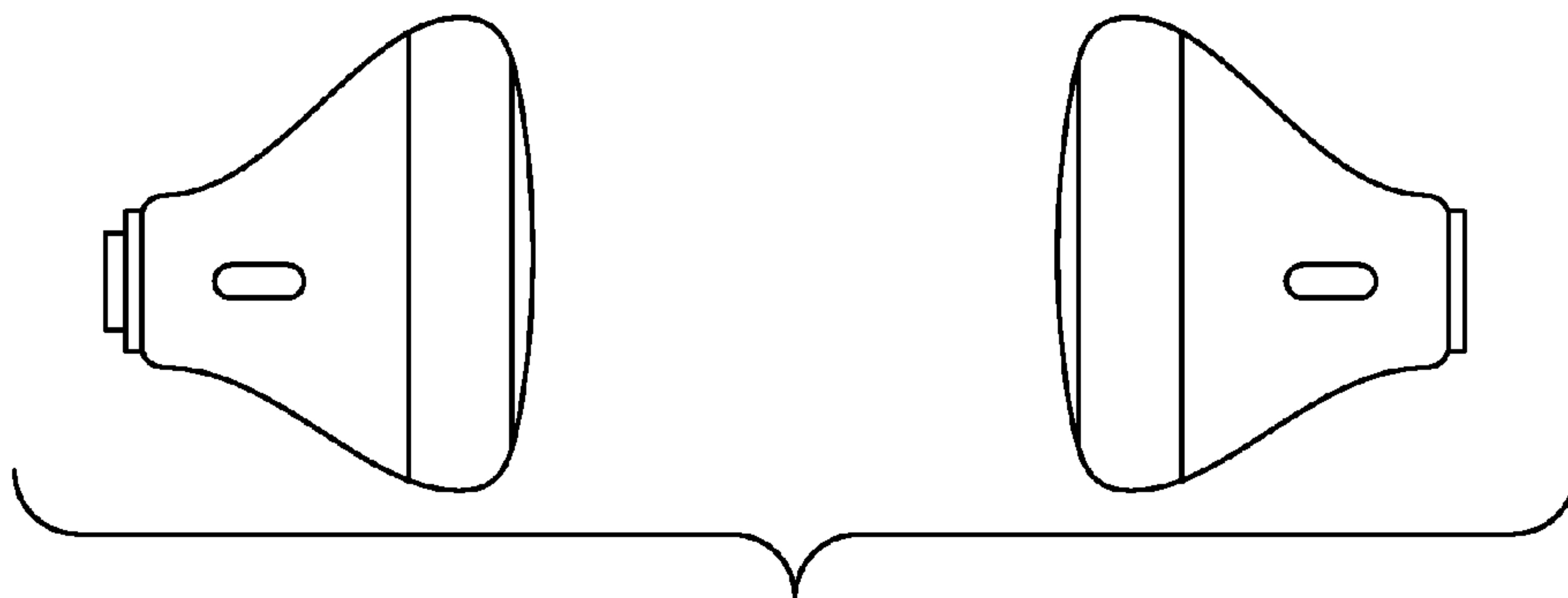

FIG. 13

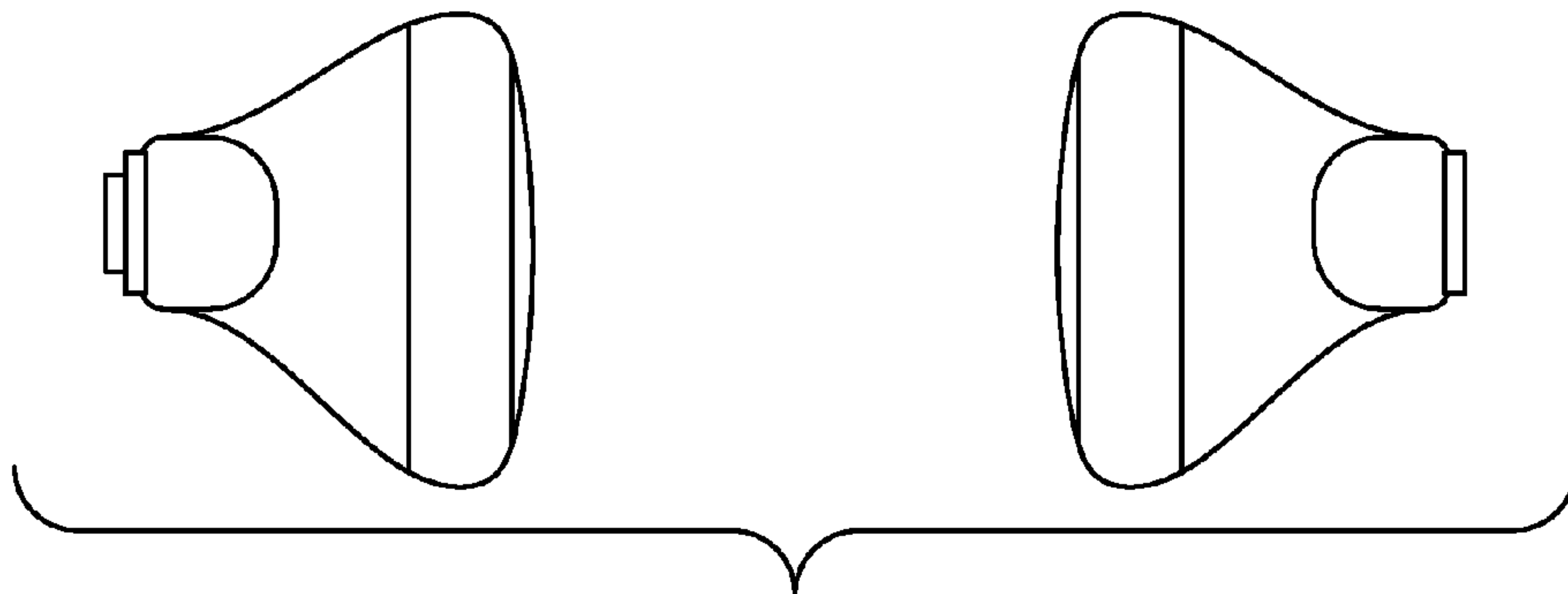

FIG. 14