

US00D573910S

(12) **United States Design Patent**
Rooney

(10) **Patent No.:** **US D573,910 S**

(45) **Date of Patent:** **** Jul. 29, 2008**

(54) **SAMPLE OPTICAL TEST APPARATUS**

(76) Inventor: **Matthew Rooney**, 12 Granville Rd.,
Dorridge, Solihull (GB) B93 6BY

(**) Term: **14 Years**

(21) Appl. No.: **29/282,709**

(22) Filed: **Jul. 27, 2007**

(51) **LOC (8) Cl.** **10-04**

(52) **U.S. Cl.** **D10/81; D10/101**

(58) **Field of Classification Search** D10/81,
D10/96, 101; D24/223-224; 436/165, 63,
436/68; 422/102, 55, 58, 82.05

See application file for complete search history.

(56) **References Cited**

U.S. PATENT DOCUMENTS

D218,986 S *	10/1970	Hahn	D10/101
D244,554 S *	5/1977	Jones et al.	D24/224
4,126,417 A *	11/1978	Edwards	422/56
5,496,704 A *	3/1996	Fiedler et al.	435/7.22
7,074,577 B2 *	7/2006	Haubert et al.	435/7.24

* cited by examiner

Primary Examiner—Antoine D Davis
(74) *Attorney, Agent, or Firm*—Galbreath Law Offices, P.C.;
John A. Galbreath

(57) **CLAIM**

The ornamental design for a sample optical test apparatus, as shown and described.

DESCRIPTION

FIG. 1 is a perspective view of the invention;
FIG. 2 is another perspective view of the invention, showing the side opposite that shown in FIG. 1 and with the apparatus inverted;
FIG. 3 is another perspective view of the invention, further illustrating the side shown in FIG. 1;
FIG. 4 is a front view of the invention;
FIG. 5 is a side view of the invention;
FIG. 6 is a back view of the invention; and,
FIG. 7 is a bottom view of the invention.

1 Claim, 7 Drawing Sheets

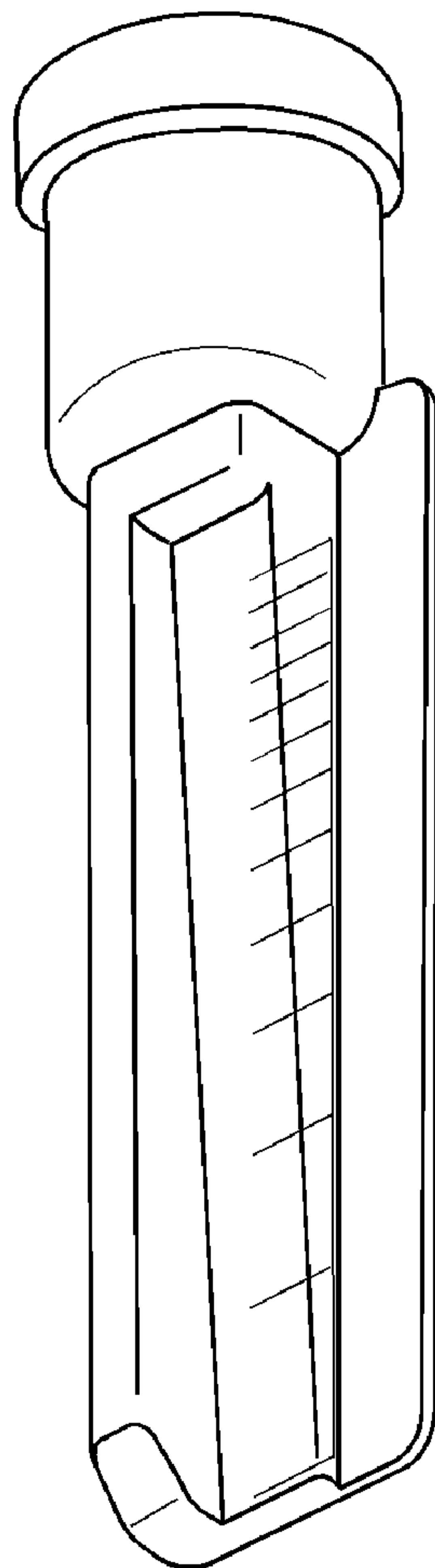

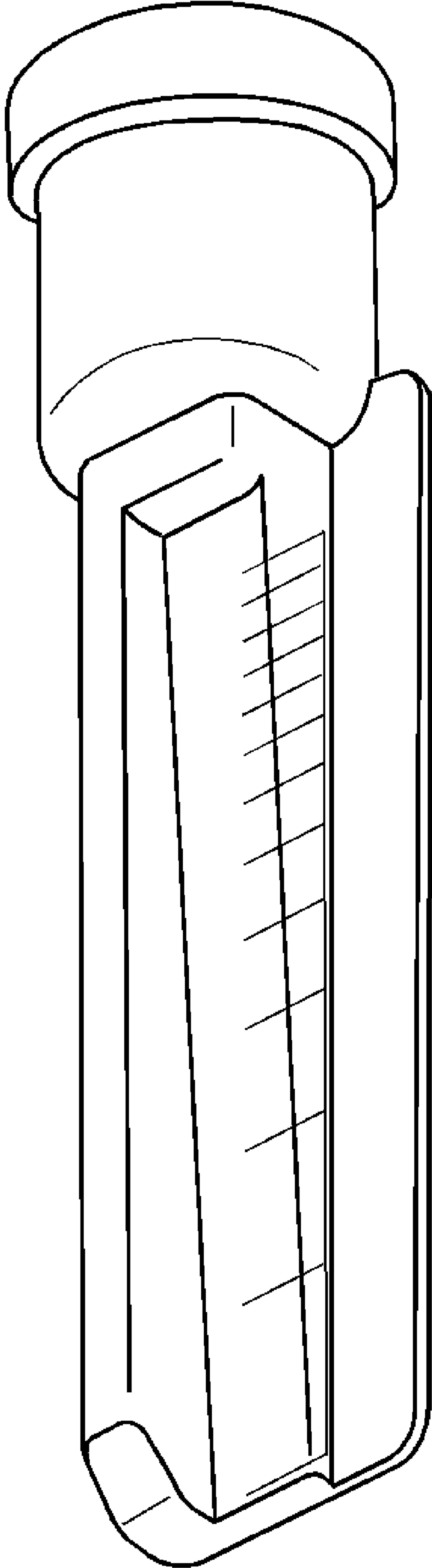

Figure 1

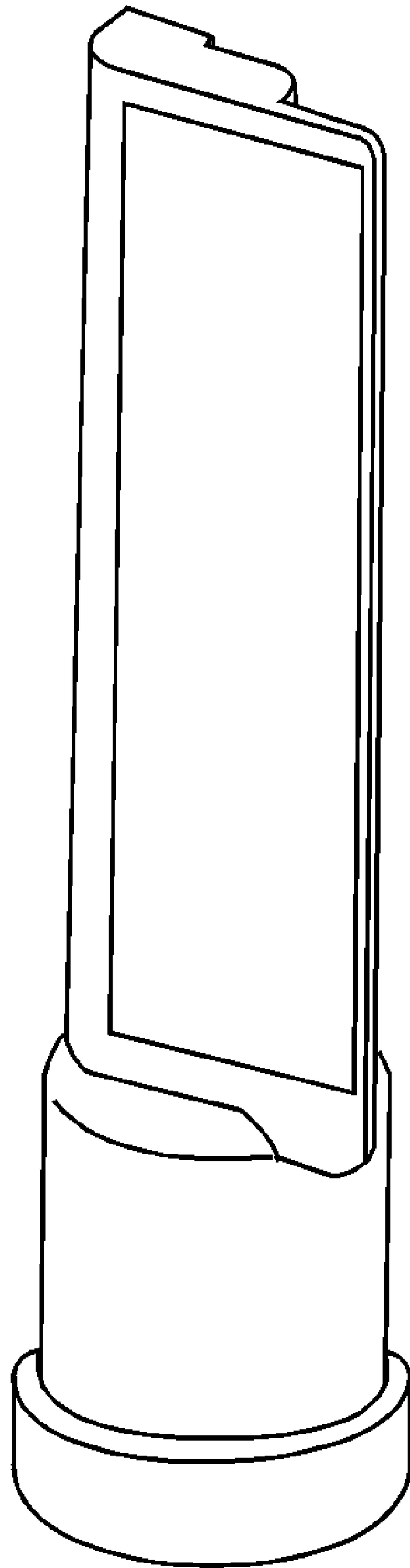

Figure 2

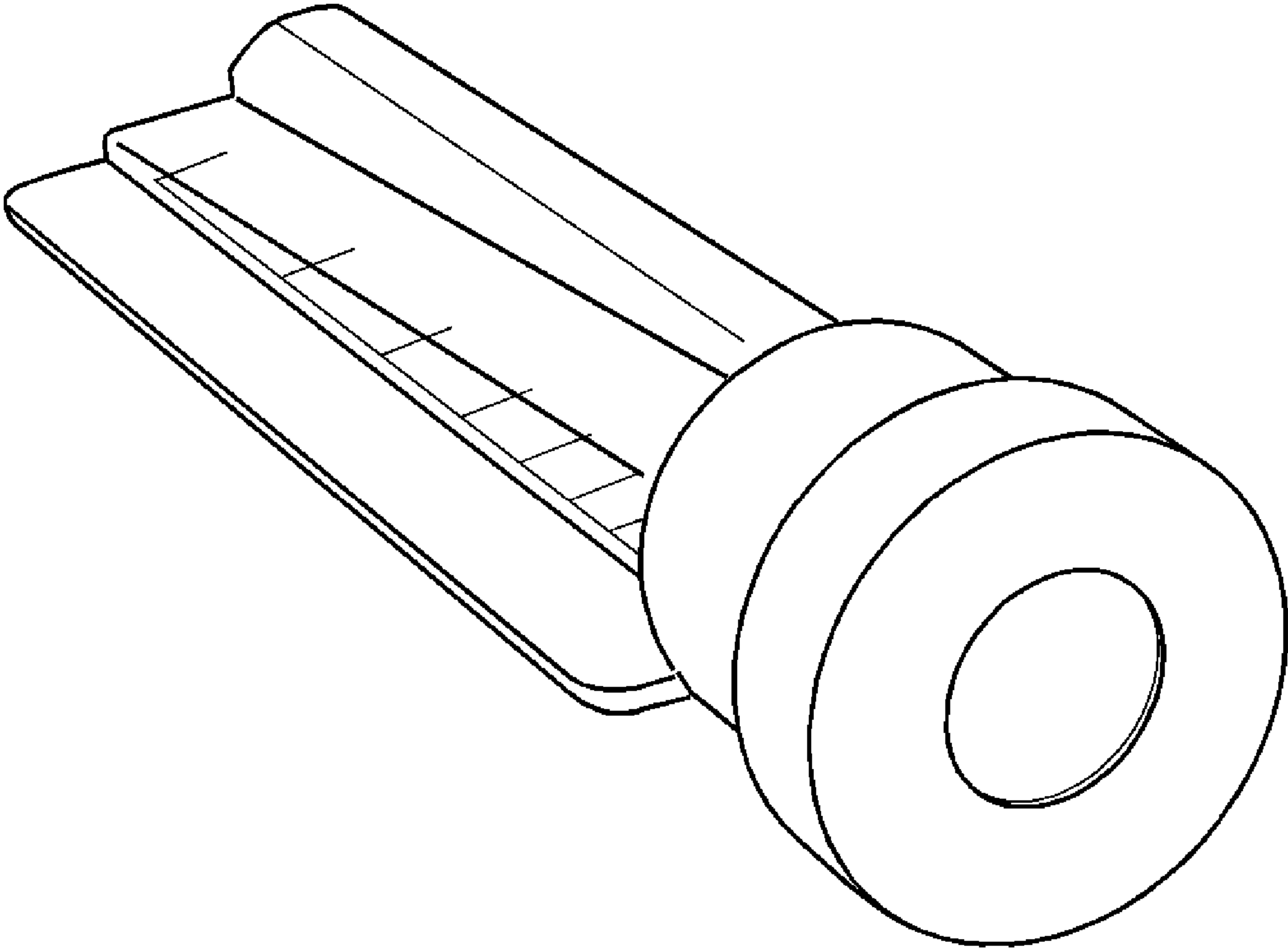

Figure 3

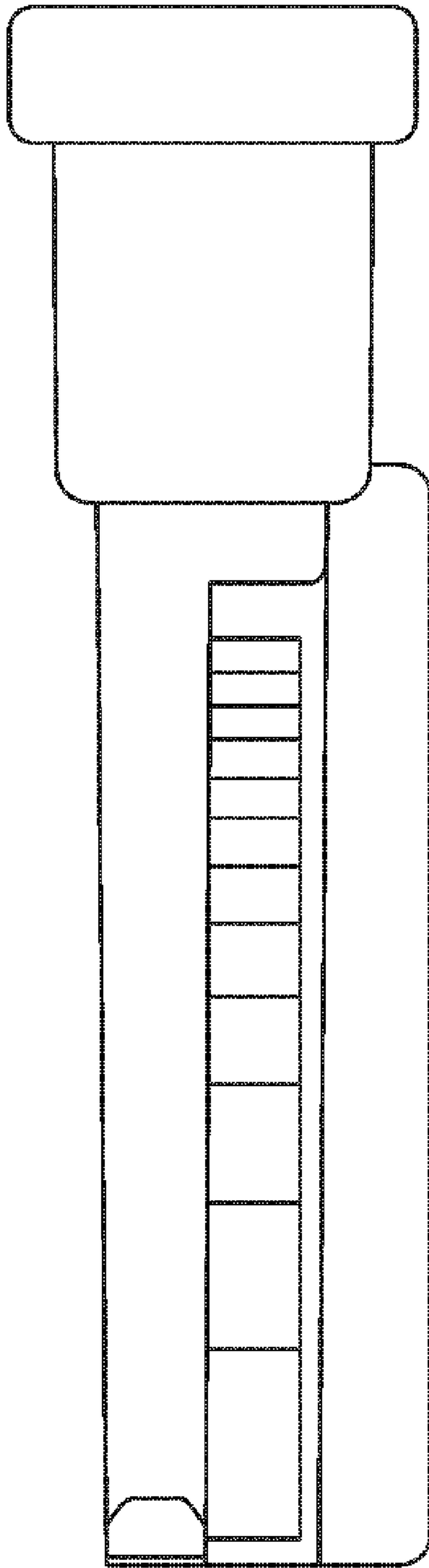

Figure 4

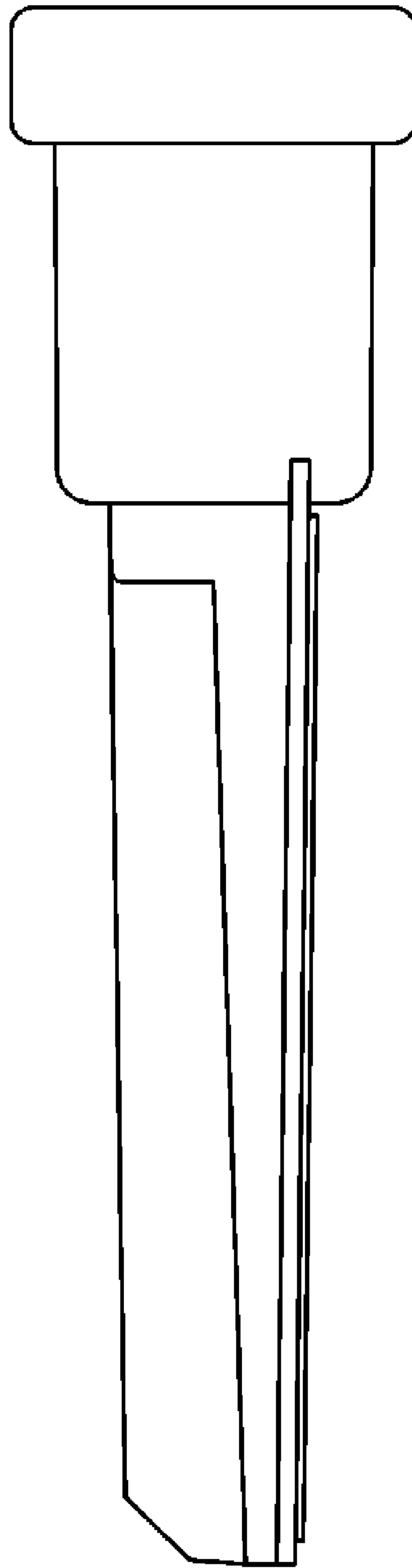

Figure 5

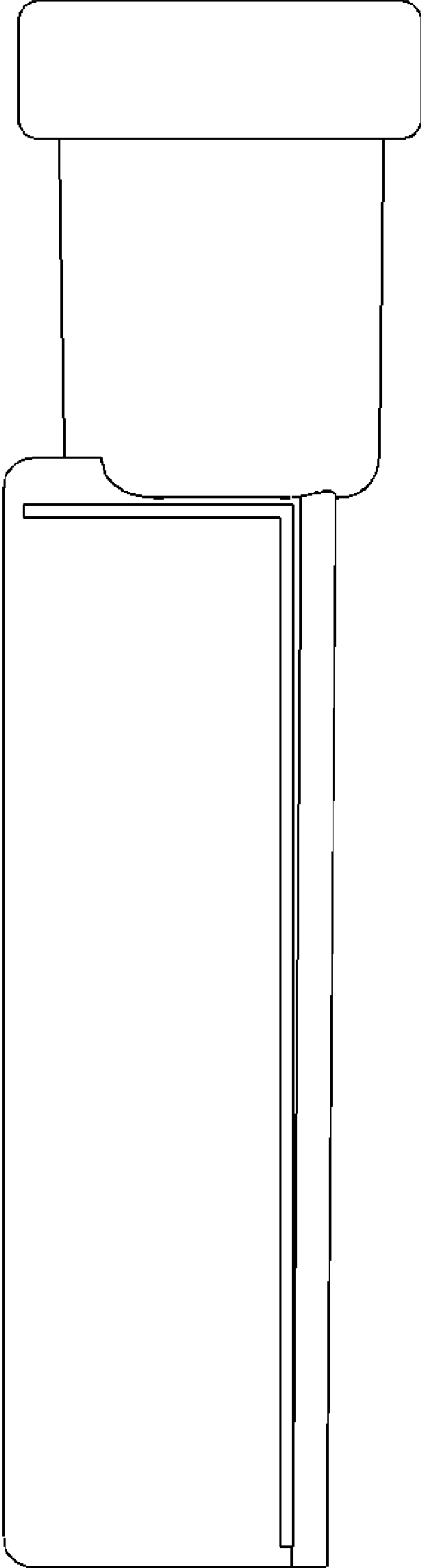

Figure 6

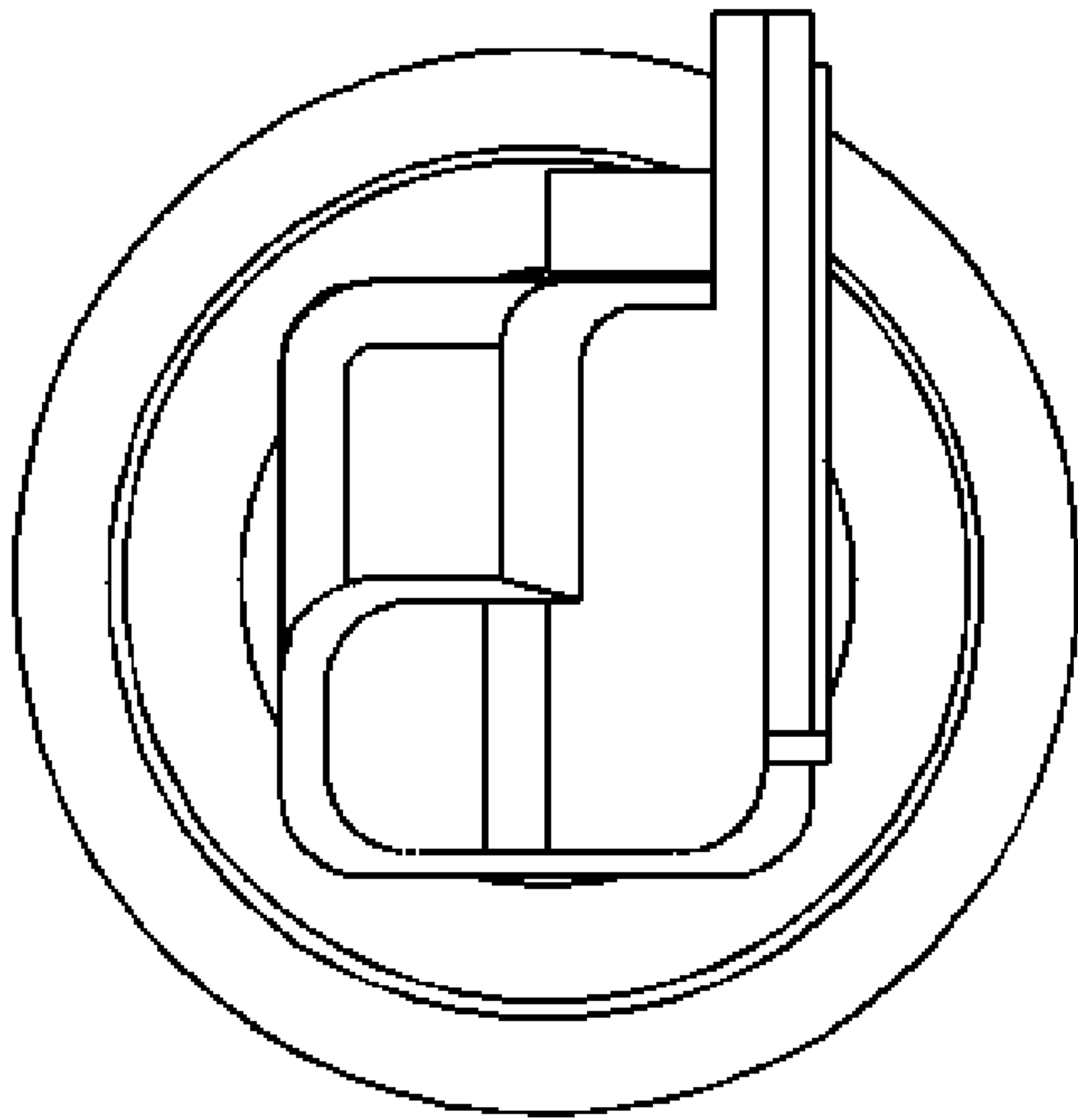

Figure 7