



US00D573869S

(12) **United States Design Patent**
Kohagen et al.

(10) **Patent No.:** **US D573,869 S**
(45) **Date of Patent:** **** Jul. 29, 2008**

(54) **HANDLE**

(75) Inventors: **Steven F. Kohagen**, Waverly, IA (US);
Nicole E. Freeberg, Roberts, WI (US)

(73) Assignee: **Waterloo Industries, Inc.**, Waterloo, IA (US)

(**) Term: **14 Years**

(21) Appl. No.: **29/280,810**

(22) Filed: **Jun. 7, 2007**

(51) **LOC (8) Cl.** **08-06**

(52) **U.S. Cl.** **D8/316**

(58) **Field of Classification Search** D8/300,
D8/306, 313, 315, 320, 321; D9/434, 553;
16/411, 428, 444; 24/265 B; D3/318; D2/958;
D29/117.2

See application file for complete search history.

(56) **References Cited**

U.S. PATENT DOCUMENTS

823,173	A	6/1906	Hunter	
D74,383	S *	2/1928	Modern et al.	D8/317
2,680,460	A	6/1954	Hyman	
D215,413	S *	9/1969	Weckman	D9/553
3,800,361	A	4/1974	Stauffer	
4,782,556	A	11/1988	Kim	
4,799,521	A	1/1989	Shick	
5,560,083	A	10/1996	Teixeira	
5,562,189	A	10/1996	Chen	
D403,229	S	12/1998	Chou	
6,408,442	B1 *	6/2002	Kang	2/167

D547,160	S	7/2007	Hand et al.	
D560,111	S *	1/2008	Ricereto	D8/316
D563,760	S *	3/2008	Hand et al.	D8/316

* cited by examiner

Primary Examiner—Paula A. Greene

(74) *Attorney, Agent, or Firm*—Calfee, Halter & Griswold LLP

(57) **CLAIM**

The ornamental design for a handle, as shown and described.

DESCRIPTION

FIG. 1 is a perspective view of a handle showing our new design;

FIG. 2 is a perspective view of the handle of FIG. 1;

FIG. 3 is a top plan view of the handle of FIG. 1;

FIG. 4 is a bottom plan view of the handle of FIG. 1;

FIG. 5 is a front elevational view of the handle of FIG. 1, the opposing rear elevational view being an exact mirror image thereof; and,

FIG. 6 is a left side elevational view of the handle of FIG. 1, the opposing right side elevational view being an exact mirror image thereof.

The portions of the Figures shown in broken lines are not part of the claimed design and are for illustration only.

The broken lines to the chest and portions of the handle are included for the purpose of illustration and form no part of the claimed design.

1 Claim, 3 Drawing Sheets

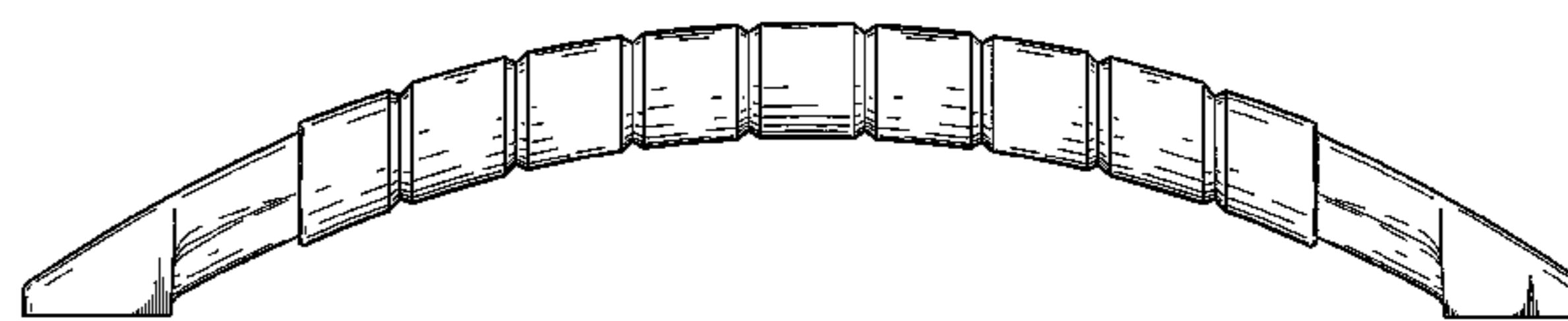
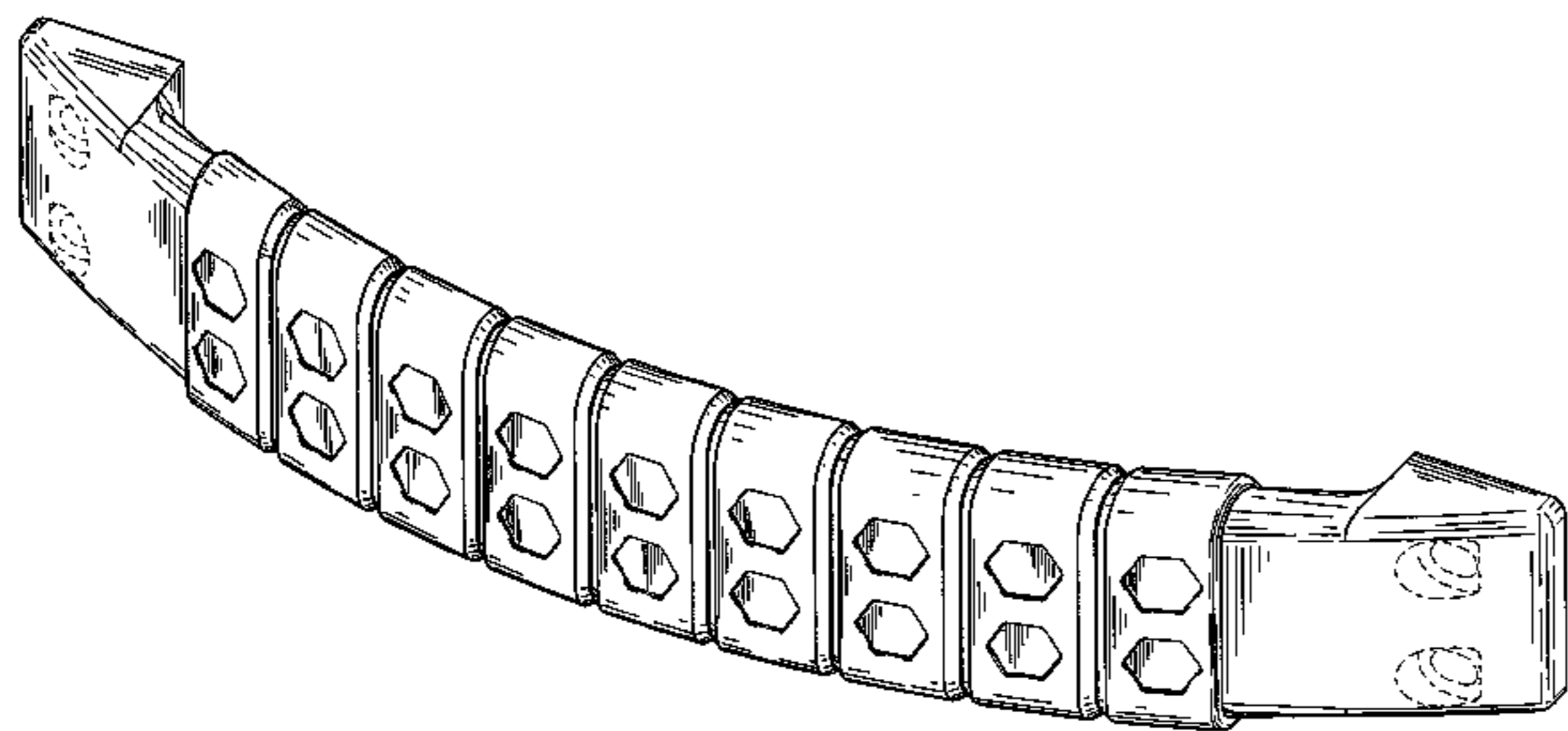

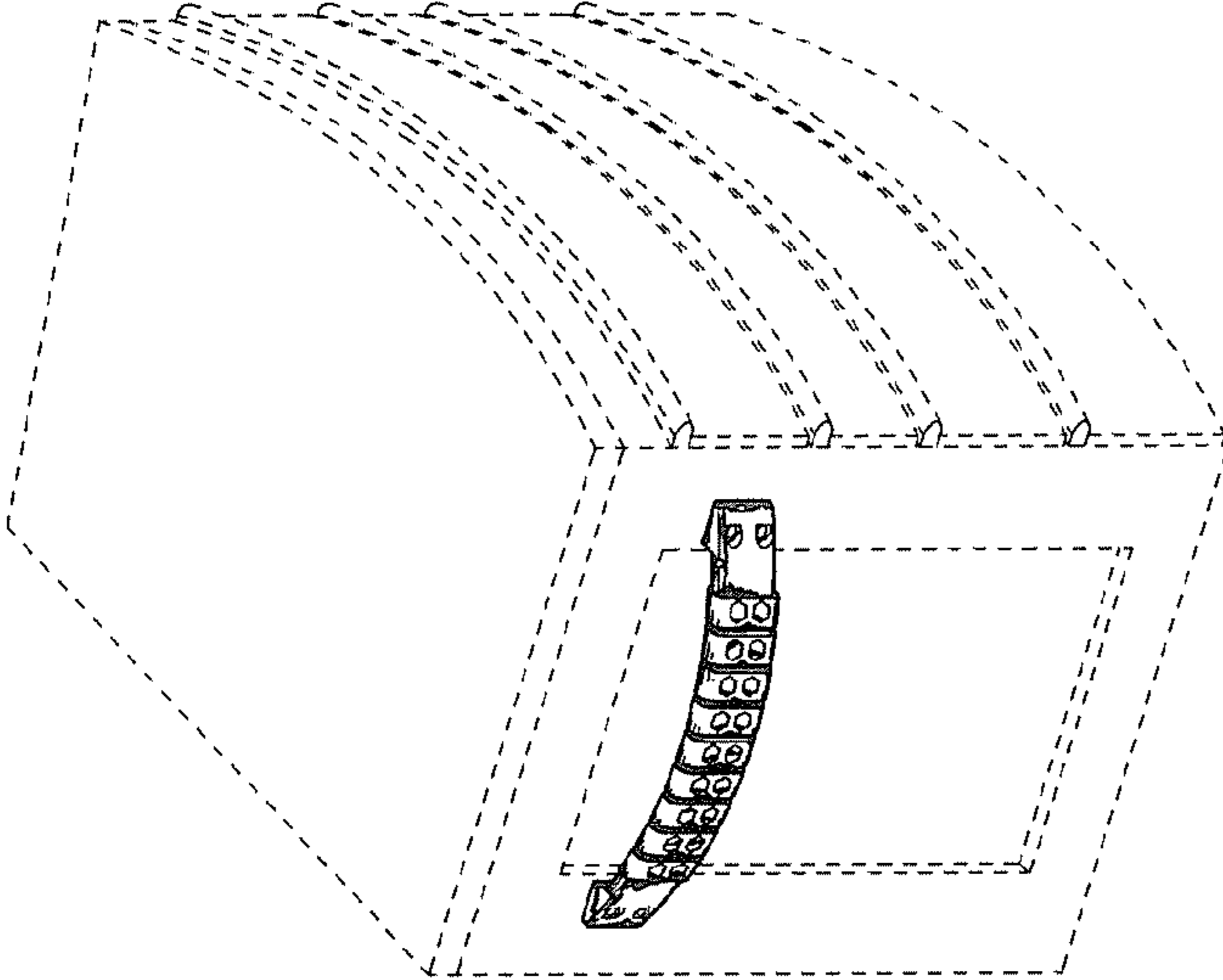

Fig. 1

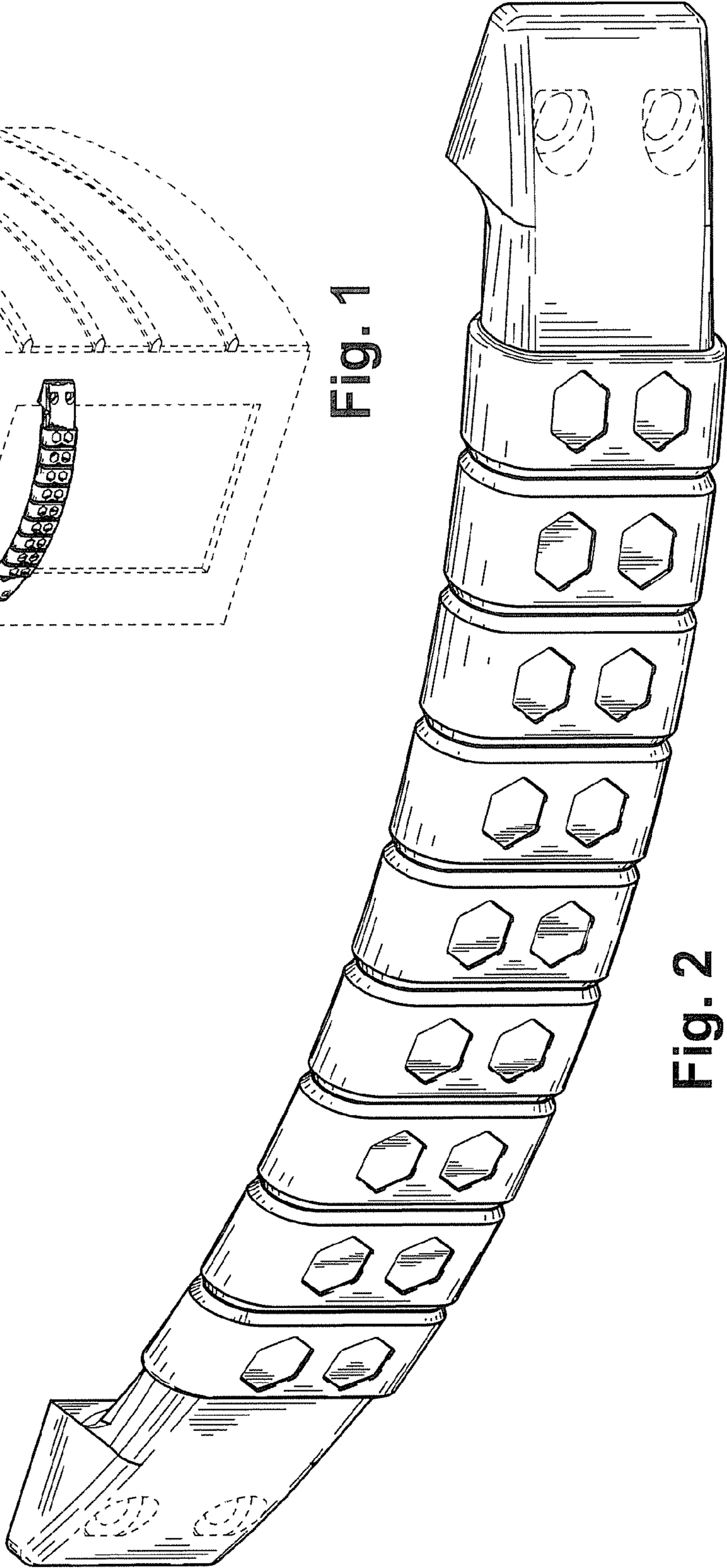

Fig. 2

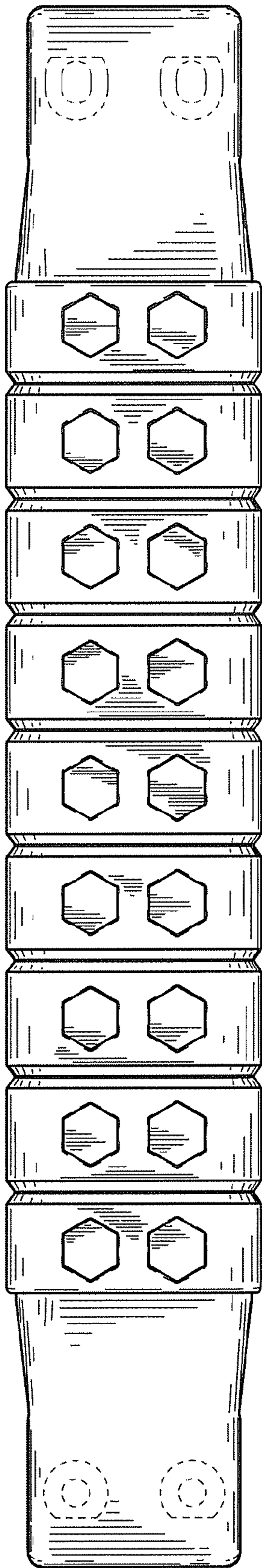

Fig. 3

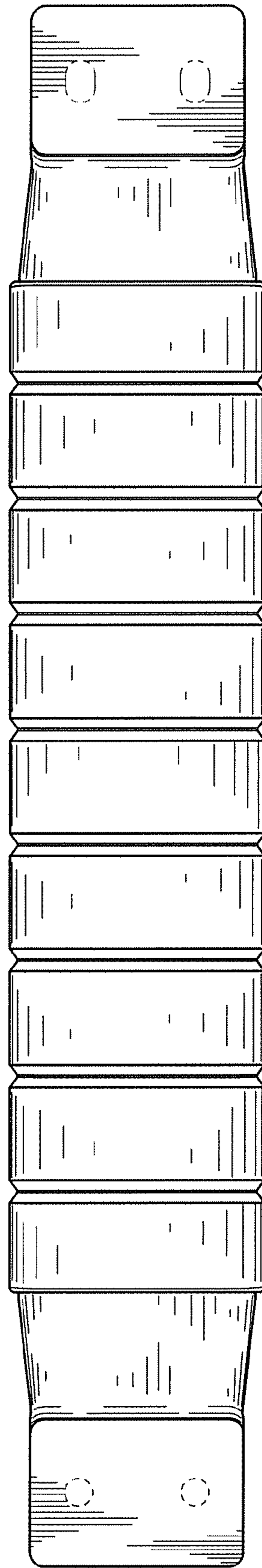

Fig. 4

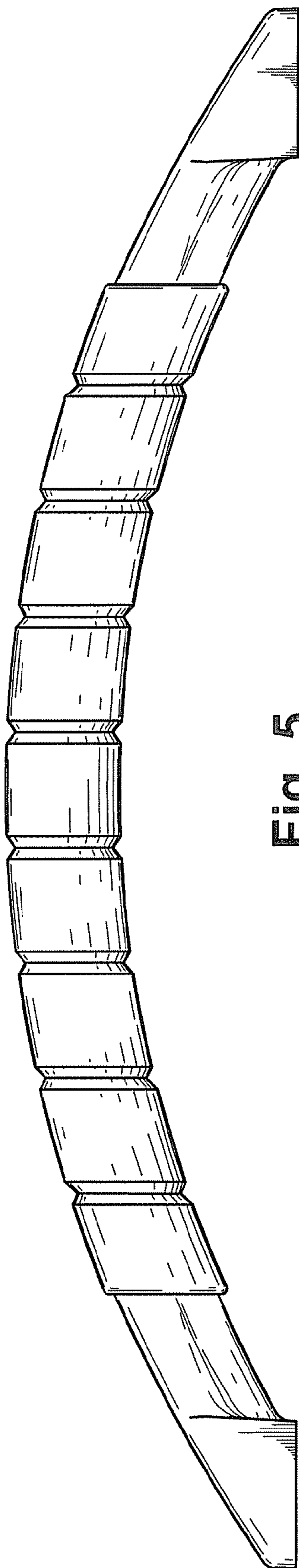

Fig. 5

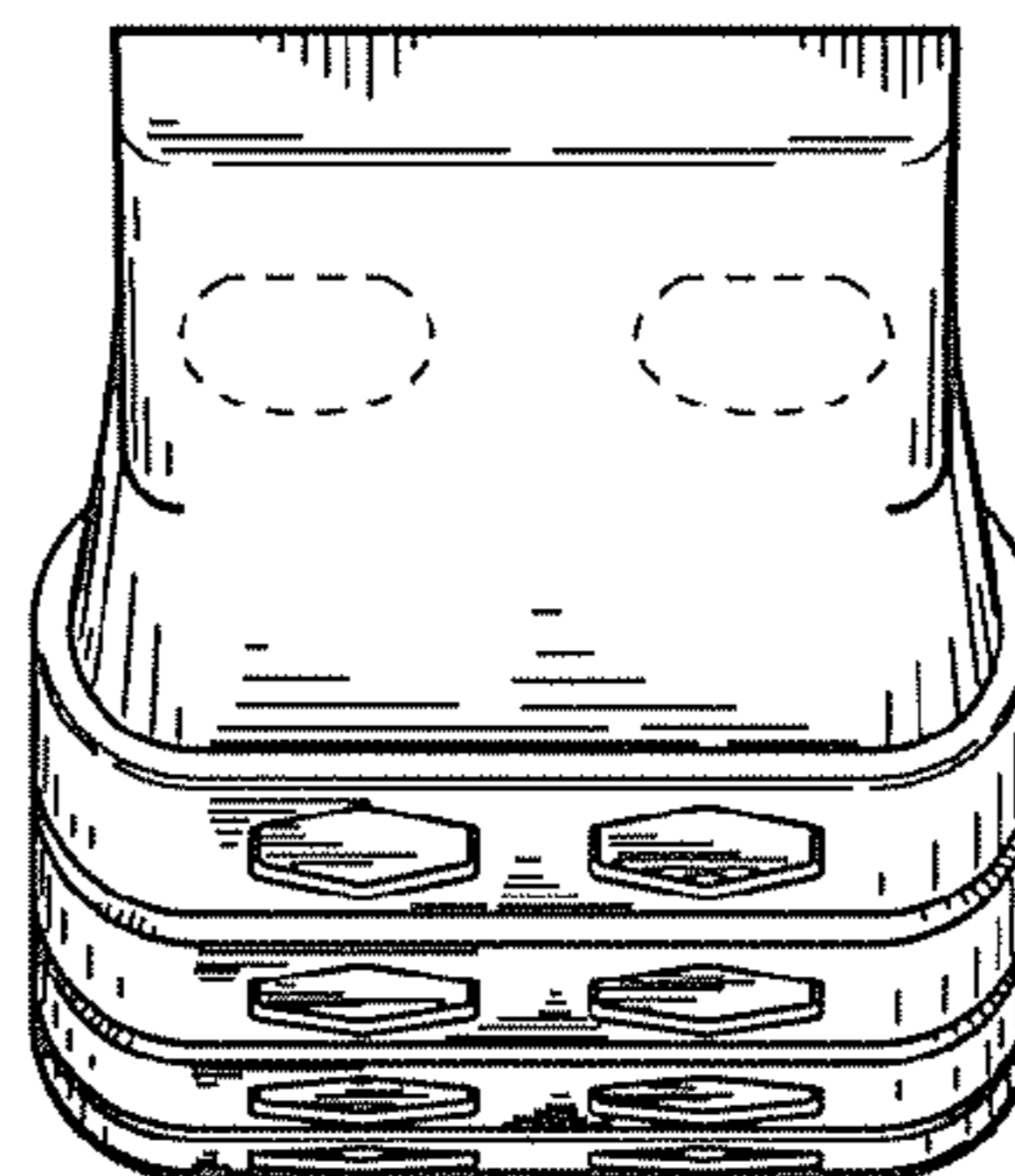

Fig. 6