



US00D573857S

(12) **United States Design Patent**
Stratford et al.

(10) **Patent No.:** **US D573,857 S**
(45) **Date of Patent:** **** Jul. 29, 2008**

- (54) **SANDER**
- (75) Inventors: **Mark Stratford**, Darlington (GB);
Mark Baxter, Newcastle-upon-Tyne (GB)
- (73) Assignee: **Black & Decker Inc.**, Newark, DE (US)
- (**) Term: **14 Years**
- (21) Appl. No.: **29/281,020**
- (22) Filed: **Jun. 13, 2007**
- (51) **LOC (8) Cl.** **08-01**
- (52) **U.S. Cl.** **D8/62**
- (58) **Field of Classification Search** D8/67,
D8/62, 61, 70; D32/15, 17, 19; D4/102;
451/456, 451, 359, 358, 357, 356, 355, 364,
451/344

See application file for complete search history.

(56) **References Cited**

U.S. PATENT DOCUMENTS

D392,861 S	3/1998	Gildersleeve et al.	
D413,242 S	8/1999	Robson	
D416,459 S	11/1999	Pears	
D435,768 S	1/2001	Duffy	
6,179,696 B1 *	1/2001	Duffy	451/357
D447,038 S	8/2001	Netzler	
D447,397 S	9/2001	Netzler	
D453,460 S *	2/2002	Lui	D8/62
D490,676 S	6/2004	Wright	
D494,434 S *	8/2004	Sun et al.	D8/62
D507,731 S	7/2005	Robson	

D509,417 S	9/2005	Wikle et al.	
D509,720 S	9/2005	Robson	
D510,006 S	9/2005	Van Wambeke et al.	
D511,954 S *	11/2005	Heun	D8/62
D526,868 S	8/2006	Robson	
D527,594 S	9/2006	Wikle	
D527,595 S	9/2006	Wikle	
D528,387 S	9/2006	Robson	
D536,942 S	2/2007	Cooper et al.	
D538,122 S	3/2007	Etter et al.	
2006/0003680 A1 *	1/2006	Robson	451/357

* cited by examiner

Primary Examiner—Cathron Brooks

Assistant Examiner—Austin Murphy

(74) *Attorney, Agent, or Firm*—Harness, Dickey & Pierce, P.L.C.

(57) **CLAIM**

The ornamental design for a sander, as shown and described.

DESCRIPTION

FIG. 1 is a perspective view of a sander in accordance with the teachings of the present disclosure;

FIG. 2 is a top plan view of the sander of FIG. 1;

FIG. 3 is a right side elevation view of the sander of FIG. 1;

FIG. 4 is a left side elevation view of the sander of FIG. 1;

FIG. 5 is a rear elevation view of the sander of FIG. 1; and,

FIG. 6 is a front elevation view of the sander of FIG. 1.

The broken lines shown in the drawings form no part of the claimed design.

1 Claim, 3 Drawing Sheets

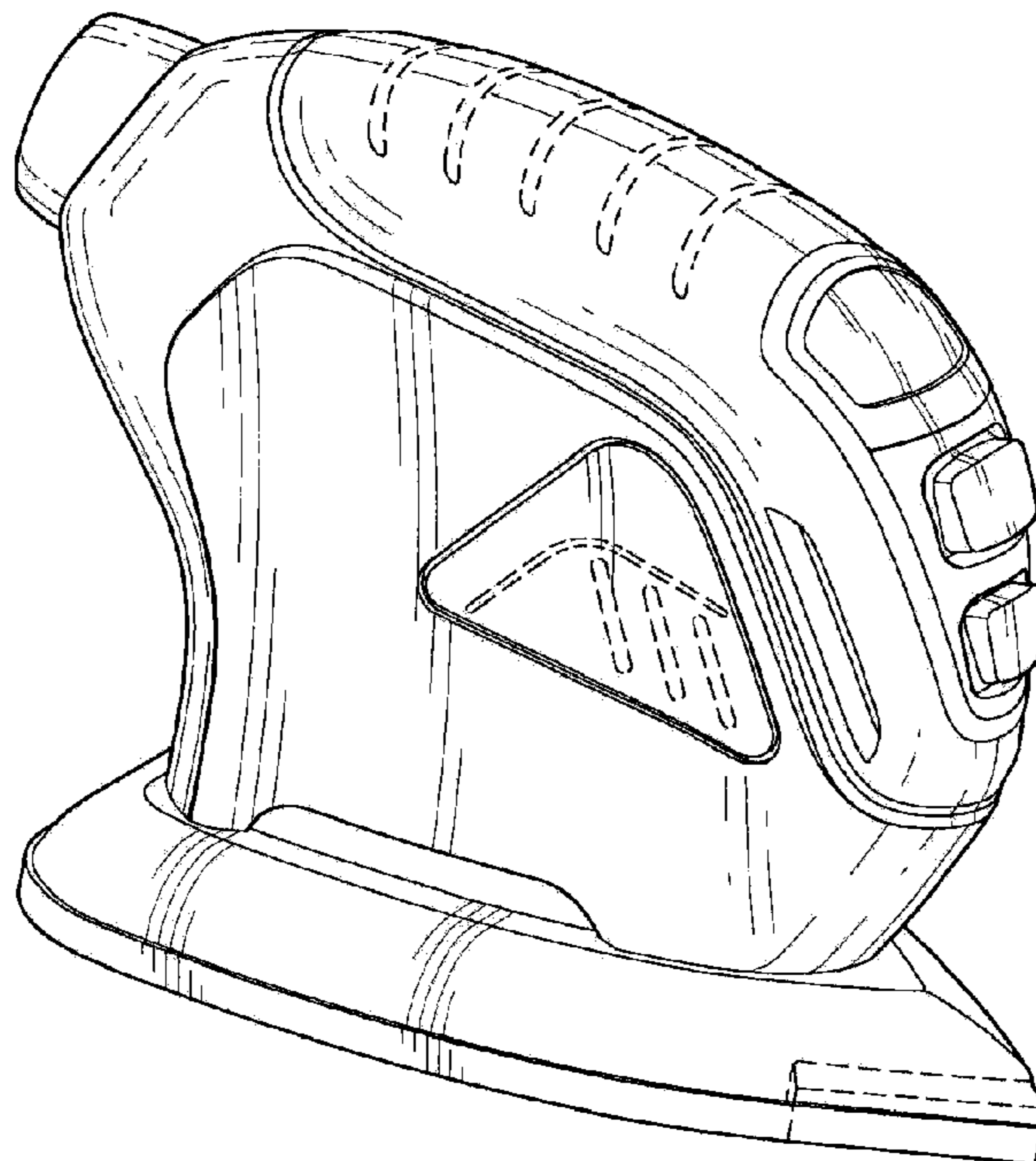

Fig-1

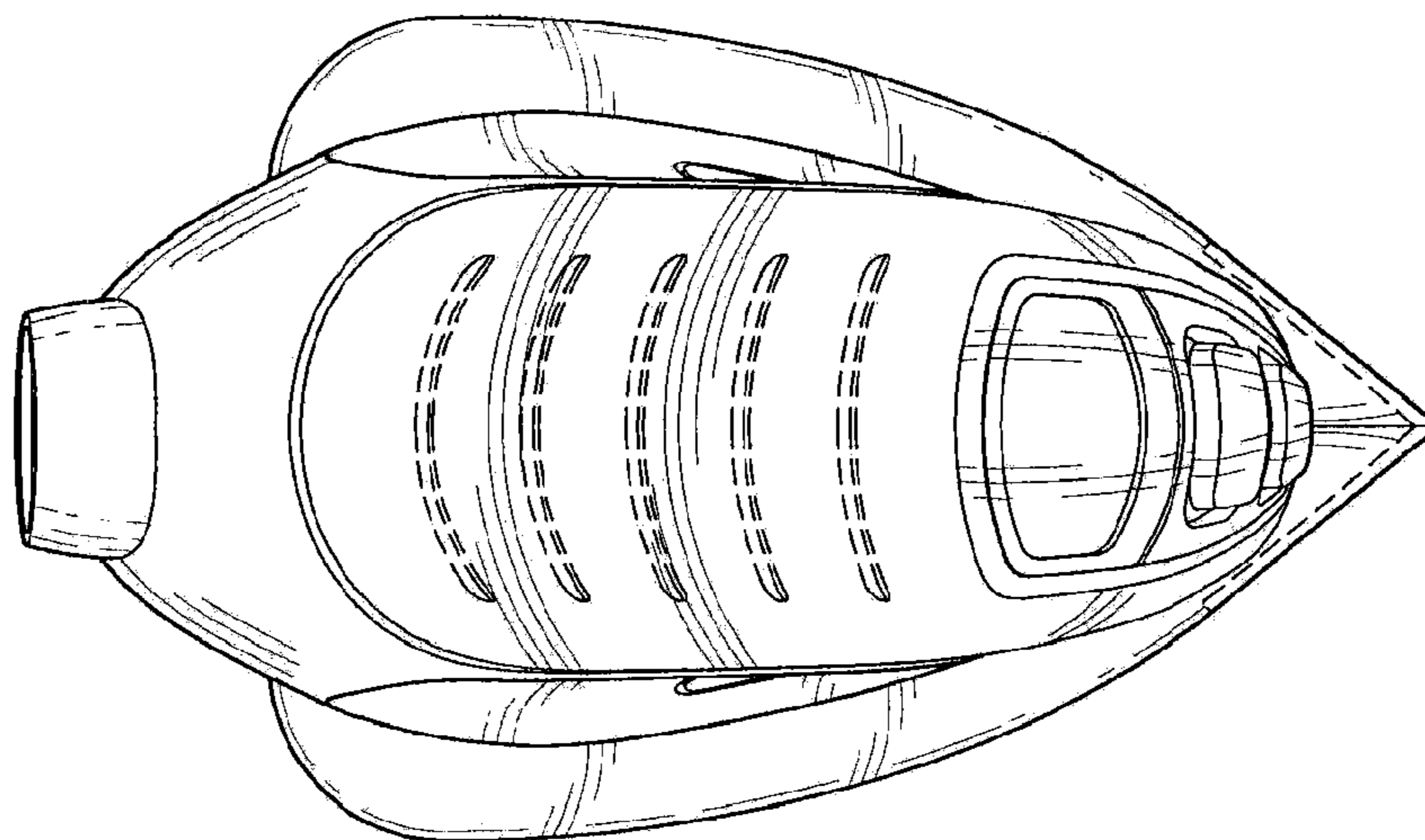
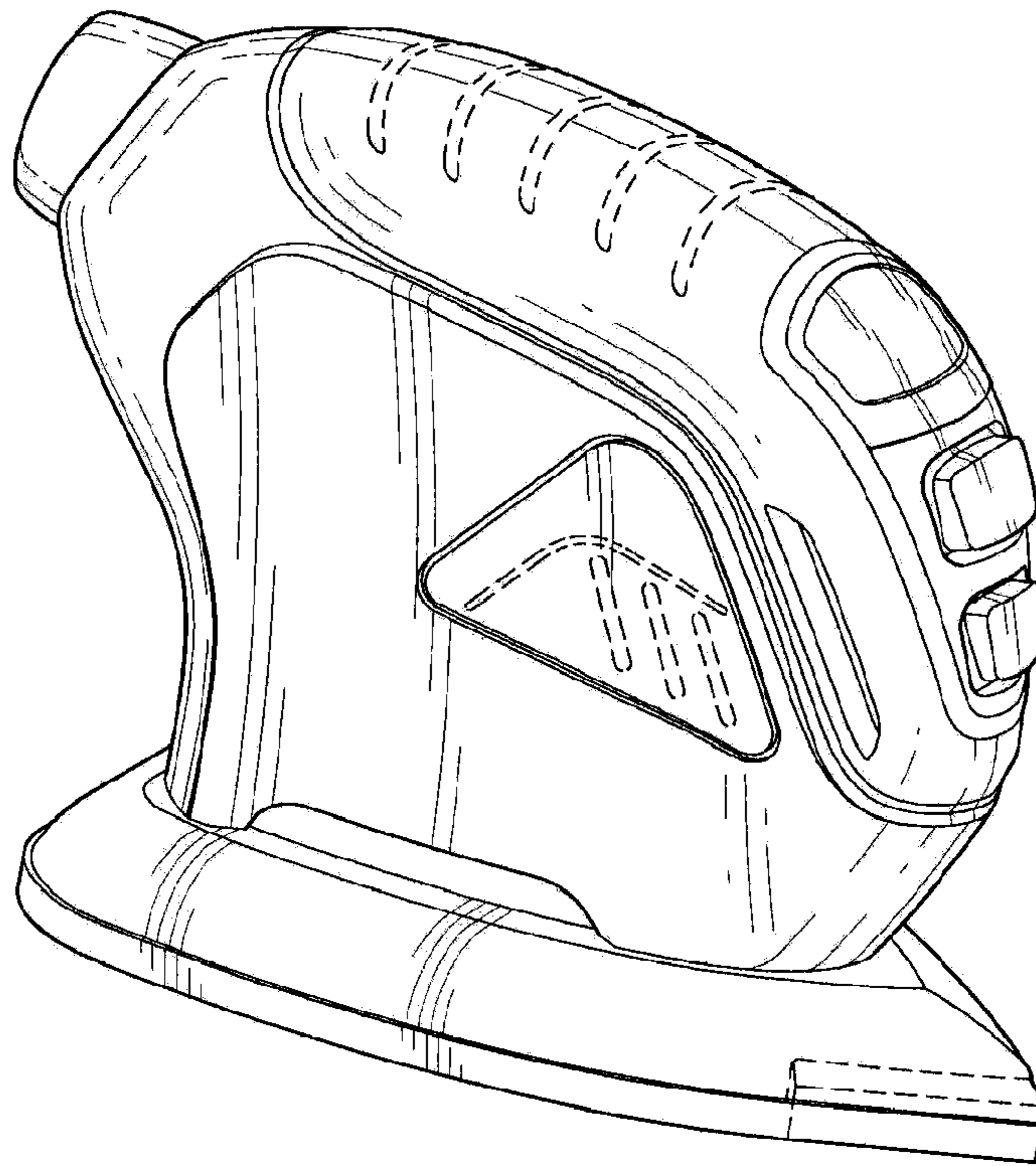

Fig-2

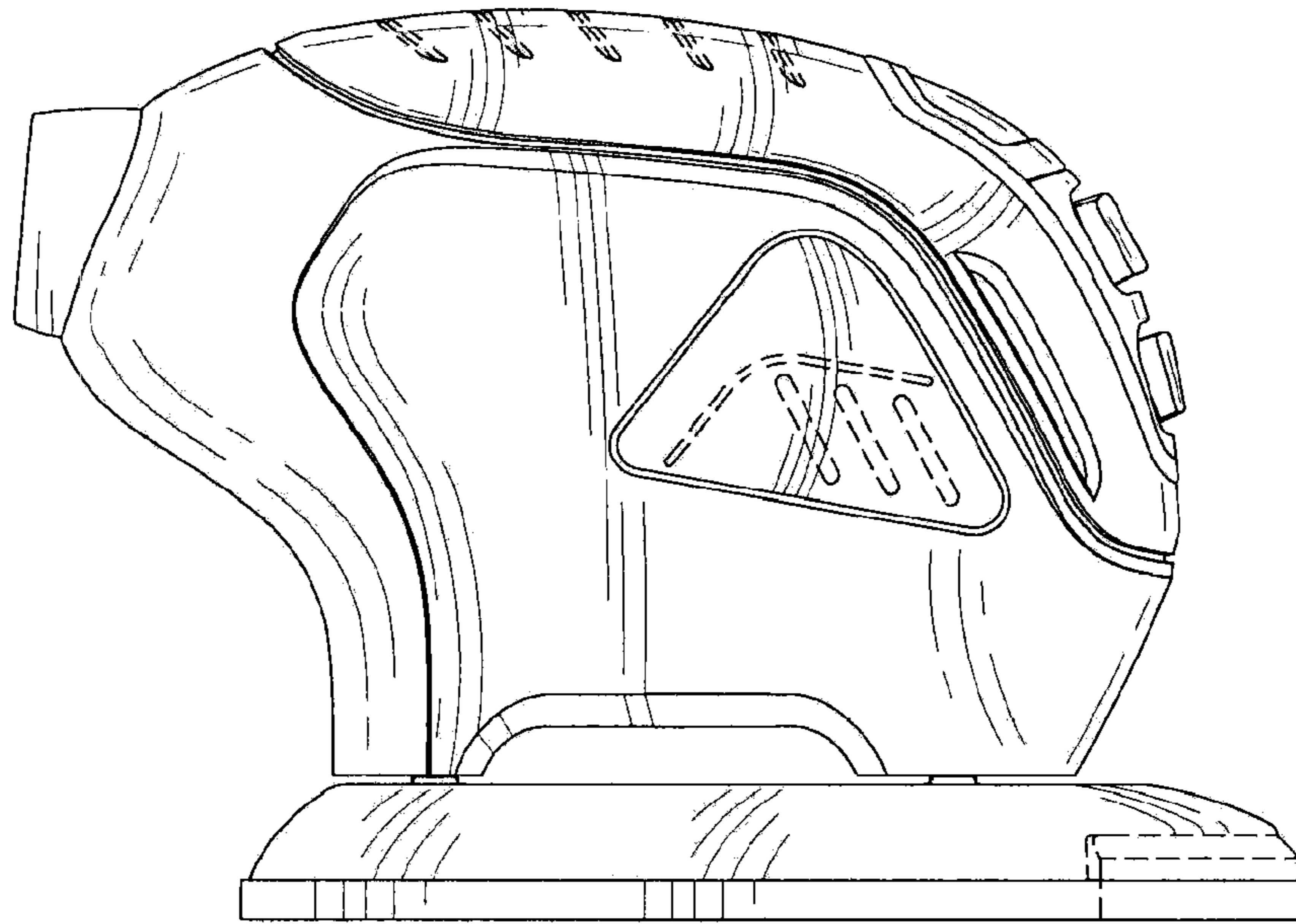

Fig-3

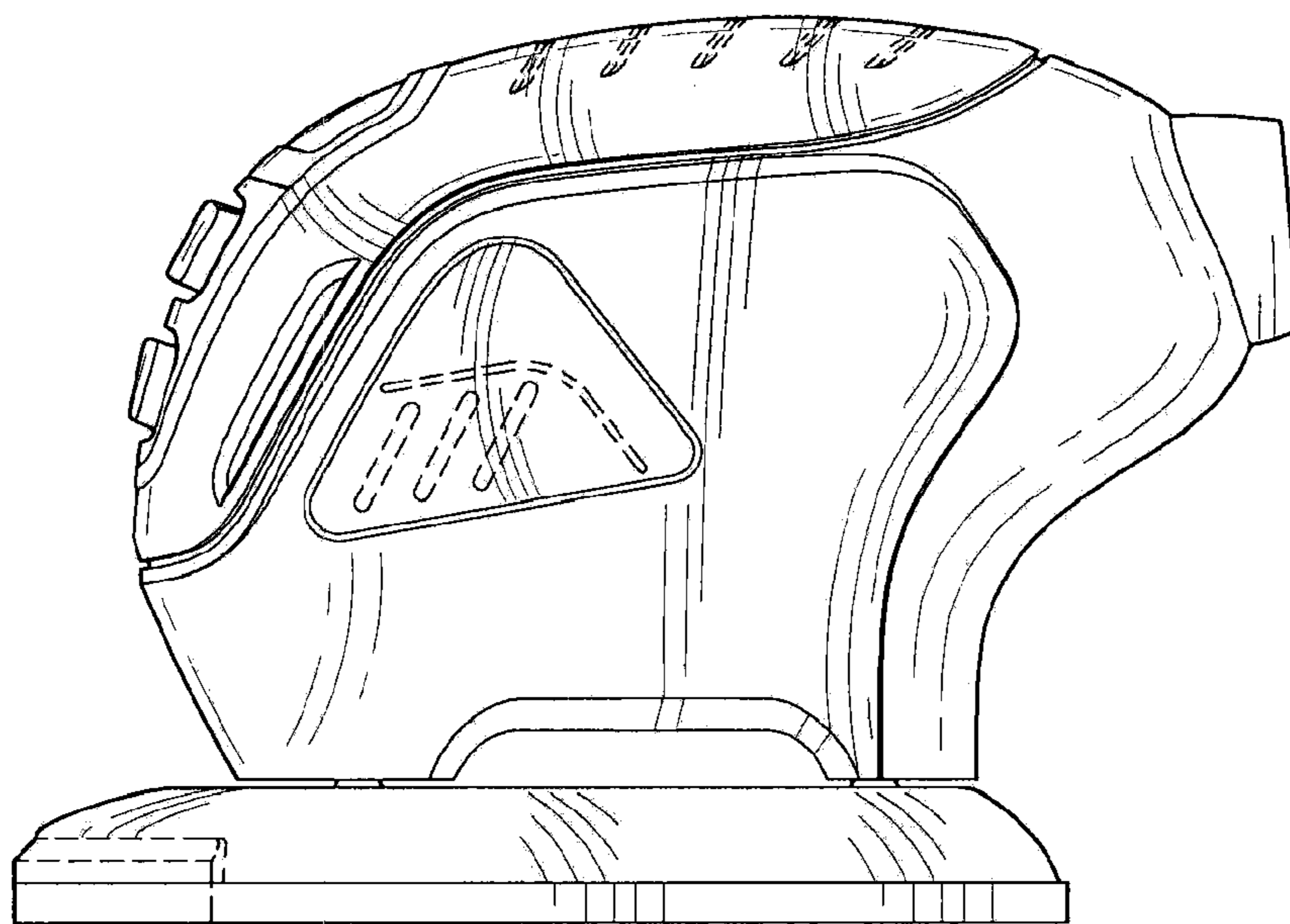

Fig-4

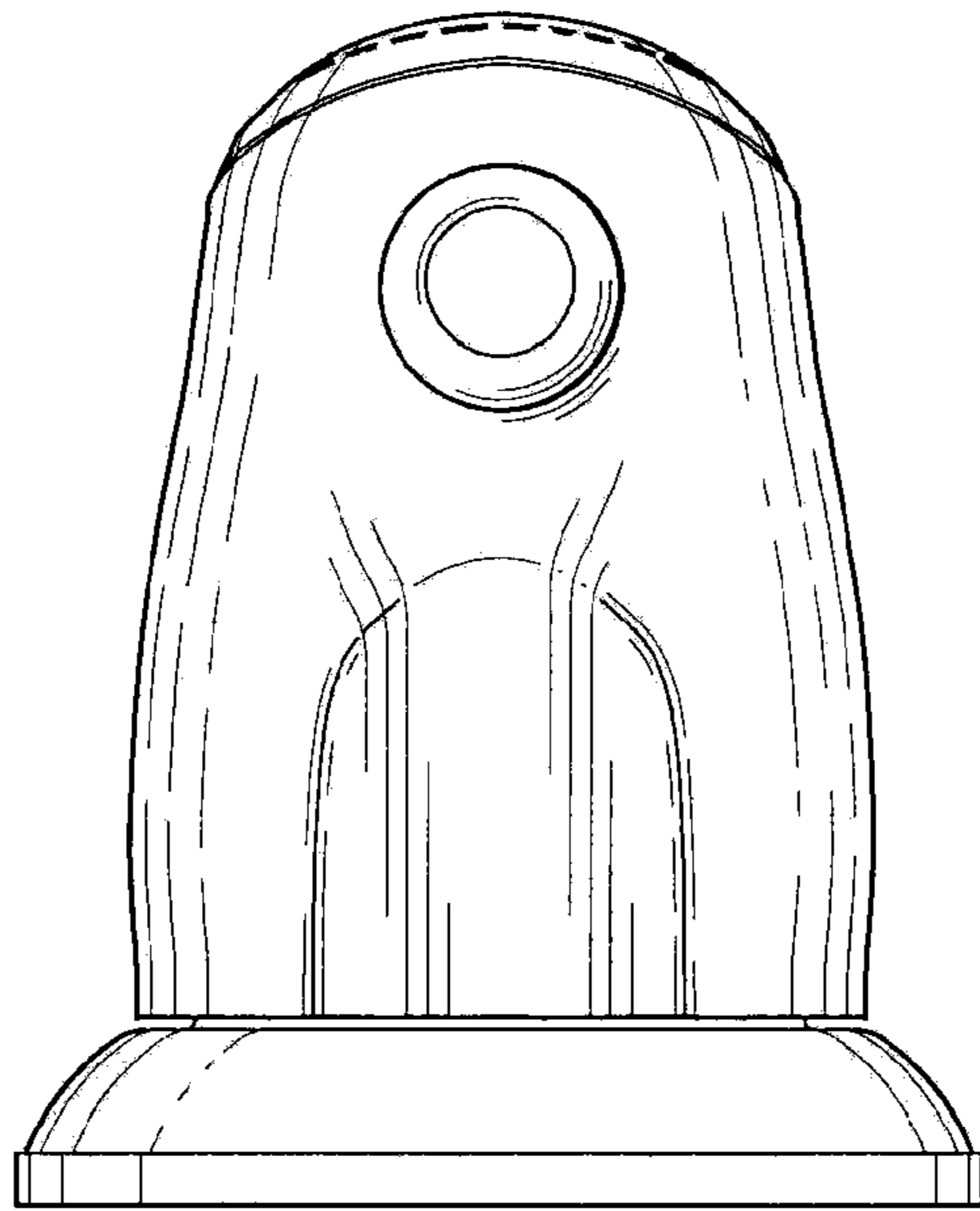

Fig-5

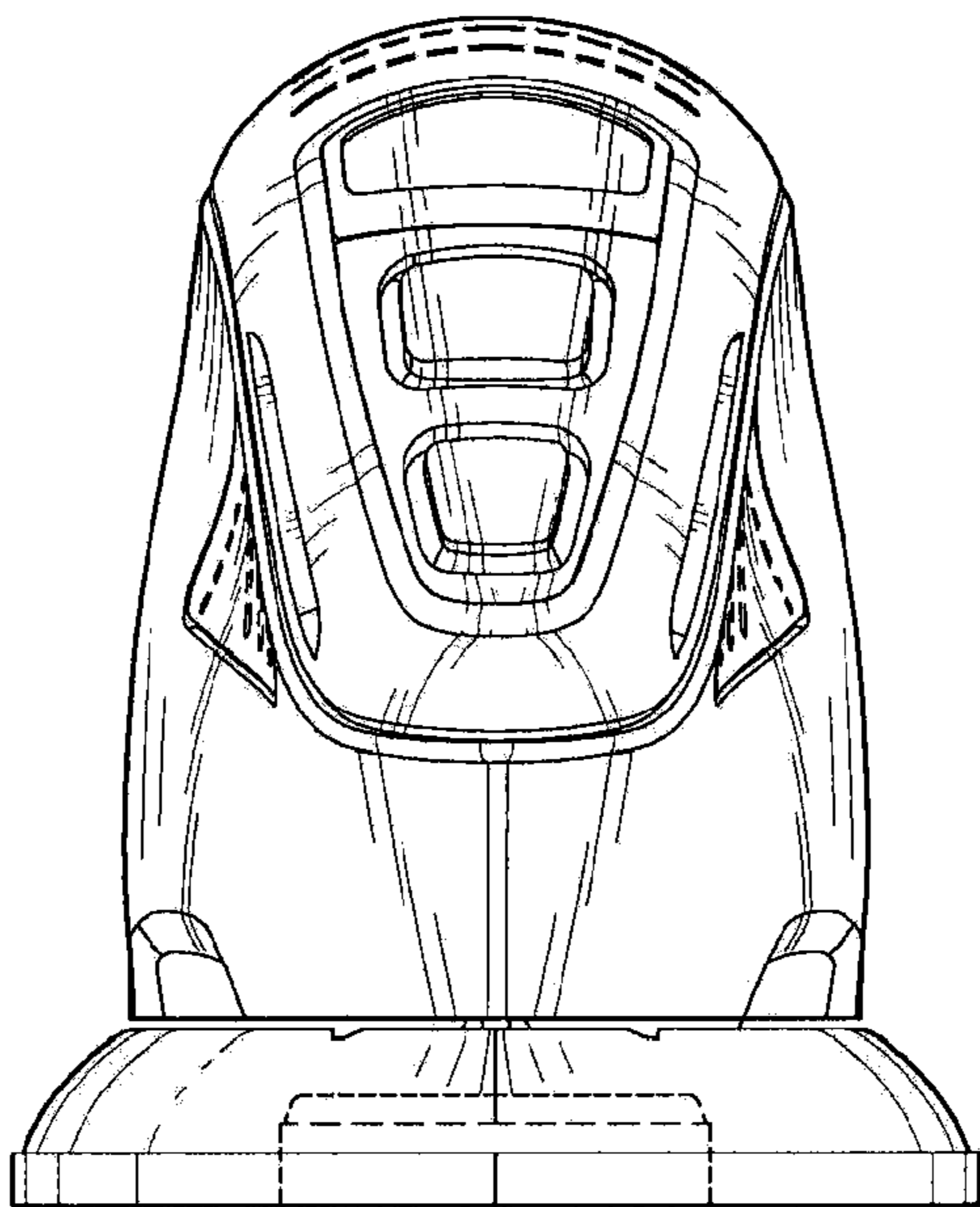

Fig-6