



US00D573809S

(12) **United States Design Patent**  
**Levy et al.**

(10) **Patent No.:** **US D573,809 S**  
(45) **Date of Patent:** **\*\* Jul. 29, 2008**

(54) **SUNGLASS RACK**

(75) Inventors: **Gordon Levy**, Denver, CO (US); **David Buckmaster**, Denver, CO (US)

(73) Assignee: **Navajo Manufacturing Company Inc.**, Denver, CO (US)

(\*\*) Term: **14 Years**

(21) Appl. No.: **29/273,747**

(22) Filed: **Mar. 13, 2007**

(51) **LOC (8) Cl.** ..... **06-04**

(52) **U.S. Cl.** ..... **D6/457**

(58) **Field of Classification Search** ..... D6/396,  
D6/449-469, 495; D25/131-134; 108/59,  
108/92-94, 103, 153; 211/1.52, 13.1, 53,  
211/85.1, 85.2, 95, 163, 205

See application file for complete search history.

(56) **References Cited**

**U.S. PATENT DOCUMENTS**

- D174,172 S \* 3/1955 Foster ..... D6/457
- 3,891,092 A \* 6/1975 Surette et al. .... 211/85.1
- D262,754 S \* 1/1982 Merl ..... D6/457
- D314,292 S \* 2/1991 Nyman ..... D6/457
- D382,420 S \* 8/1997 Woodward ..... D6/457
- D385,130 S \* 10/1997 Woodward ..... D6/457

- D401,083 S \* 11/1998 Woodward ..... D6/461
- D435,182 S \* 12/2000 Mason ..... D6/457
- D436,265 S \* 1/2001 Kidd et al. .... D6/457
- 6,443,317 B1 \* 9/2002 Brozak, Jr. .... 211/85.1
- D534,372 S \* 1/2007 Babbino et al. .... D6/457
- D554,901 S \* 11/2007 Bretz et al. .... D6/468
- D555,395 S \* 11/2007 Babbino et al. .... D6/457

\* cited by examiner

*Primary Examiner*—Caron D. Veynar

*Assistant Examiner*—Abraham Bahta

(74) *Attorney, Agent, or Firm*—Jacobson Holman PLLC

(57) **CLAIM**

The ornamental design for a sunglass rack, as shown and described.

**DESCRIPTION**

FIG. 1 is a front perspective showing my new design for a sunglass rack,

FIG. 2 is a front view thereof,

FIG. 3 is a back view thereof,

FIG. 4 is a left side view thereof,

FIG. 5 is a right side view thereof,

FIG. 6 is a top view thereof; and,

FIG. 7 is a bottom view thereof.

**1 Claim, 4 Drawing Sheets**

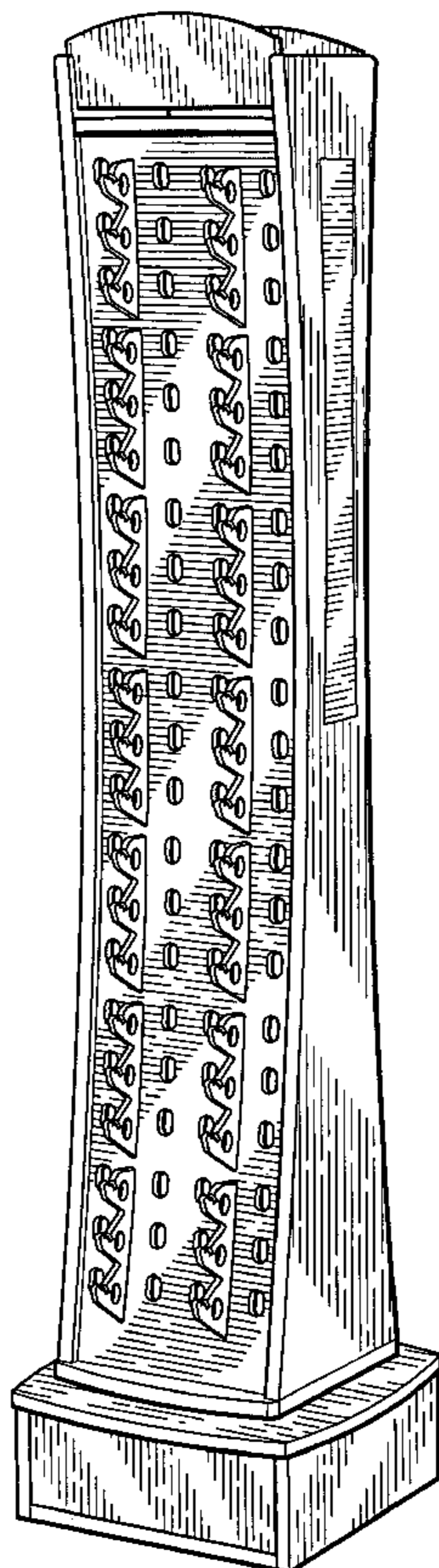
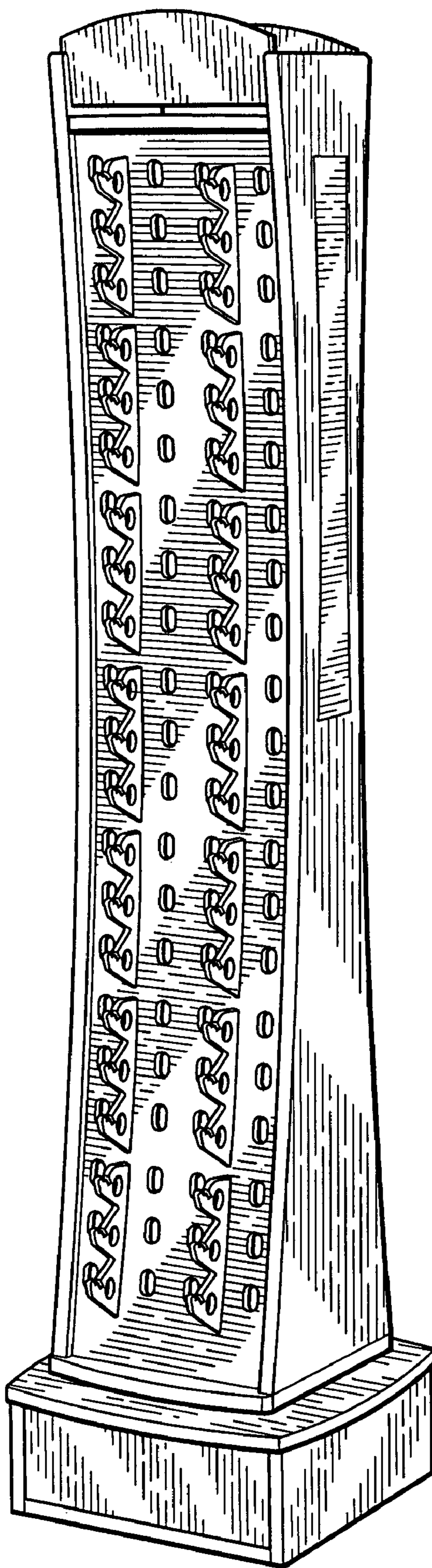

FIG. 1



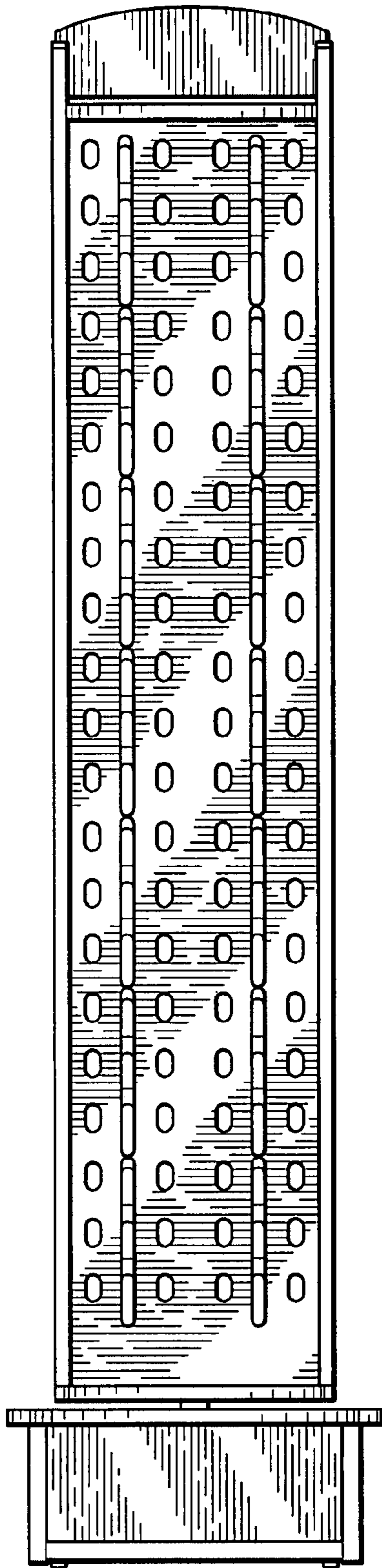

FIG. 2

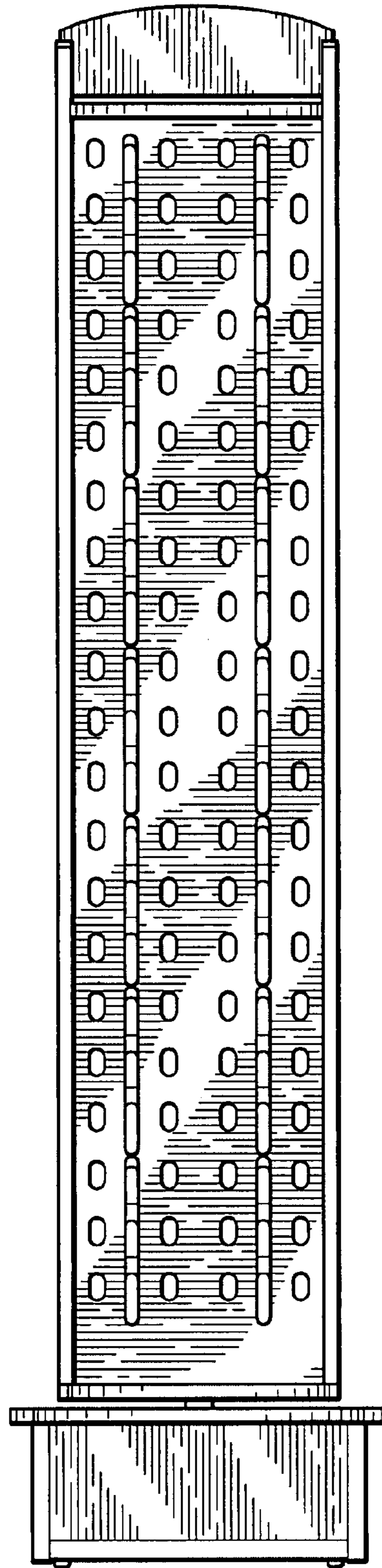

FIG. 3

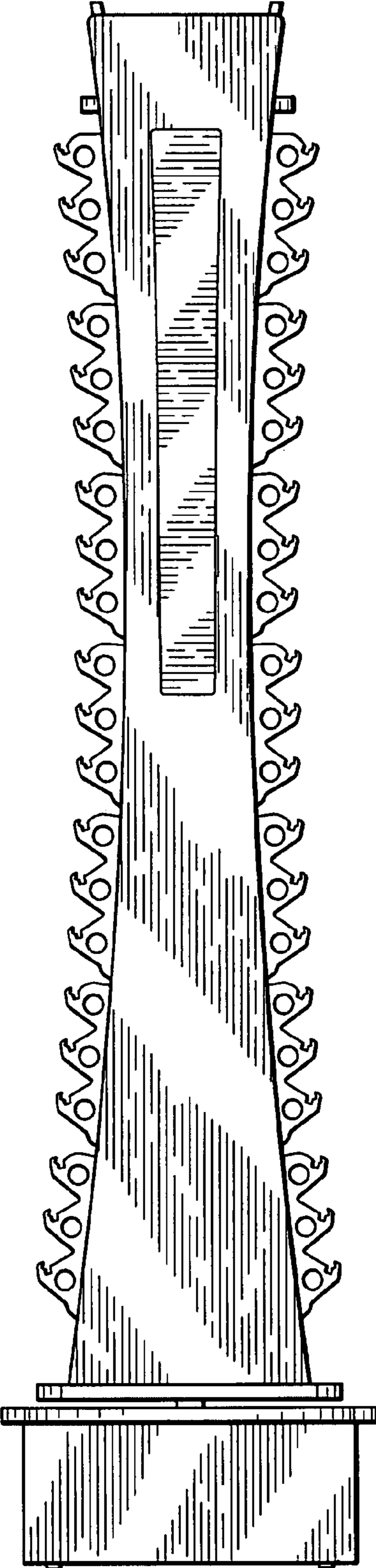

FIG. 4

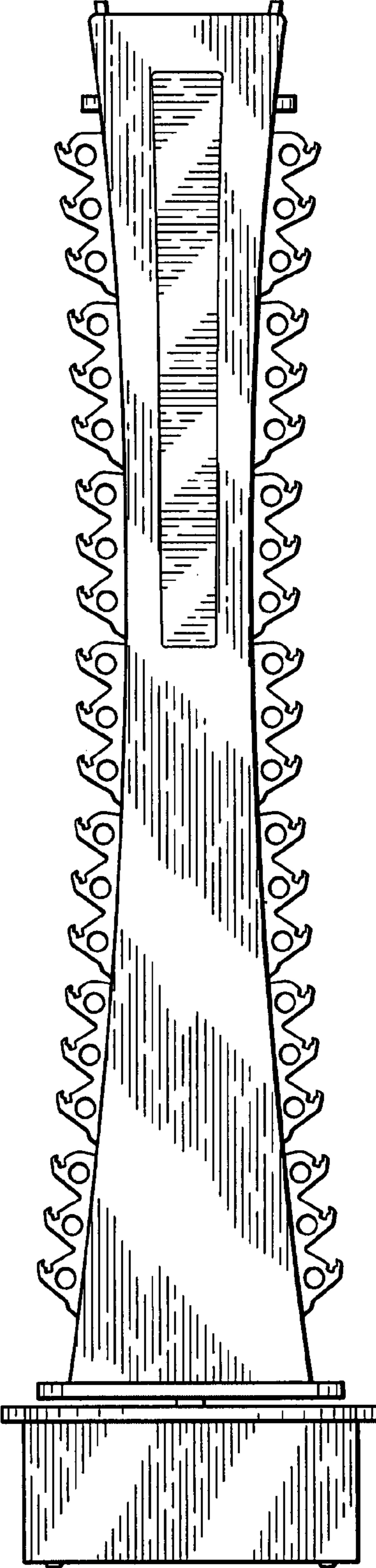

FIG. 5

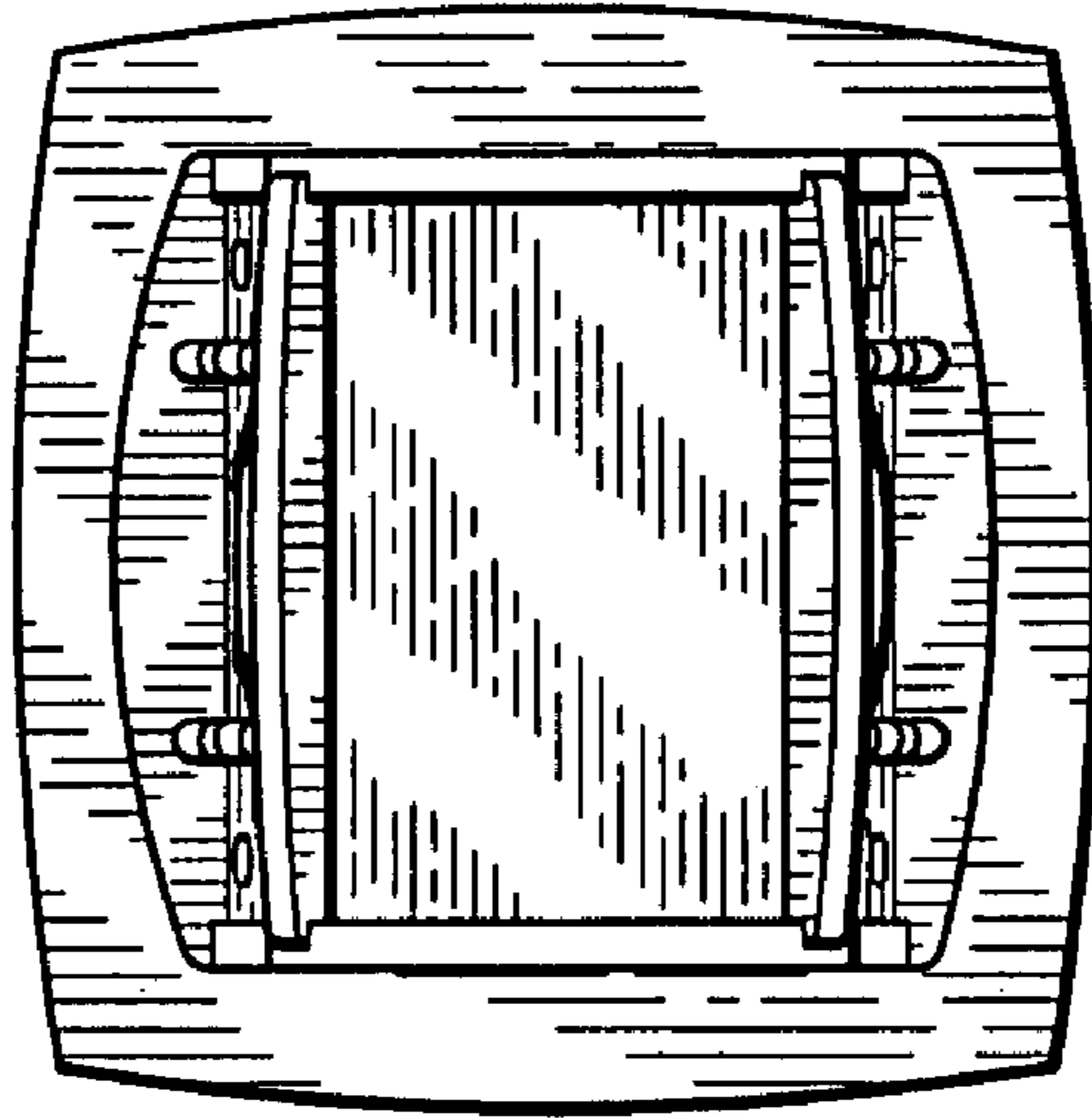

FIG. 6

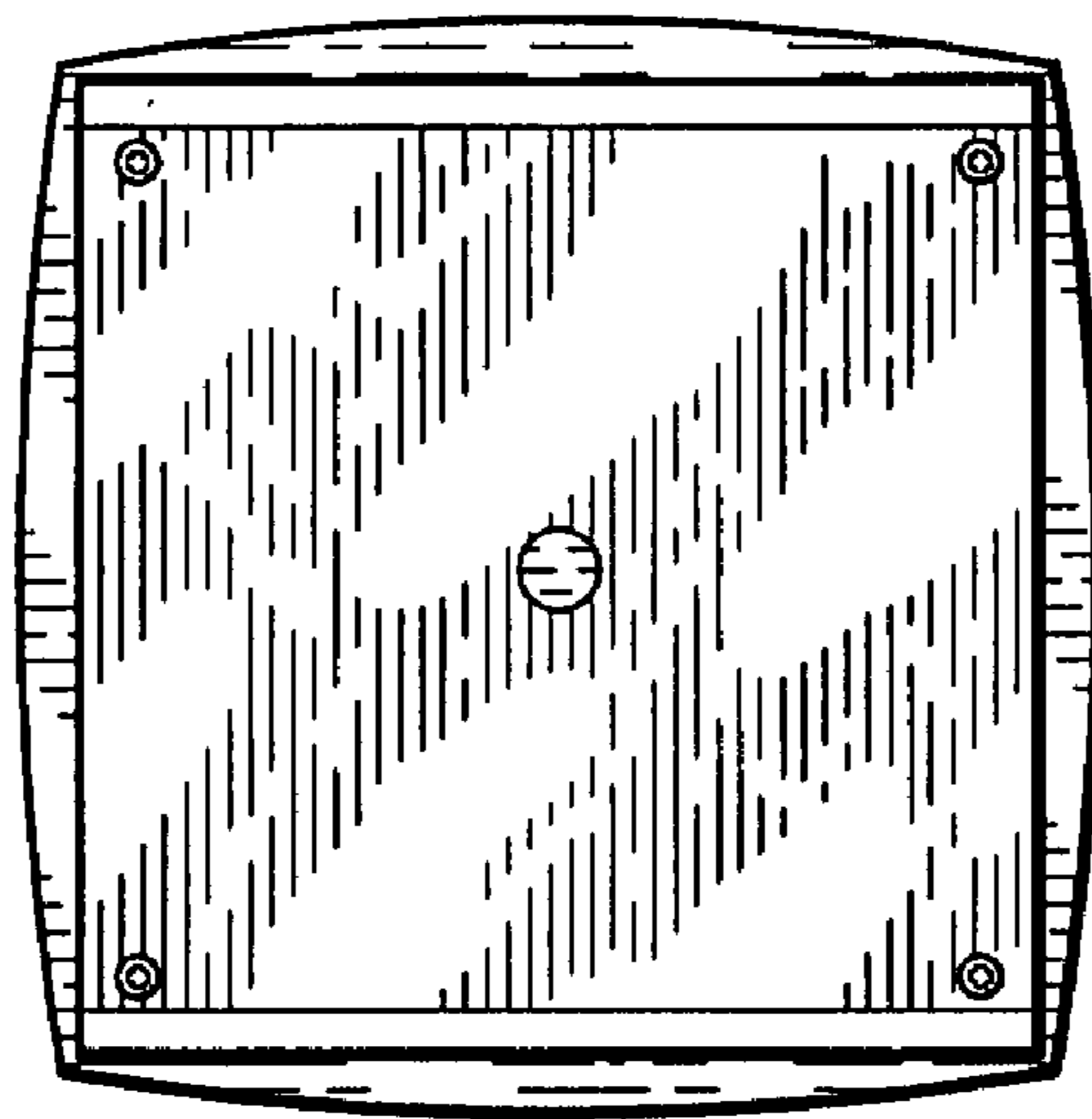

FIG. 7