



US00D573789S

(12) **United States Design Patent**  
**Eisenbraun**

(10) **Patent No.:** **US D573,789 S**  
(45) **Date of Patent:** **\*\* Jul. 29, 2008**

(54) **PORTABLE ELECTRONIC DEVICE CARRIER**

D550,954 S \* 9/2007 Boyd et al. .... D3/218  
D563,098 S \* 3/2008 Segreto ..... D3/218

(76) Inventor: **Kenneth D Eisenbraun**, 659 Overhill Rd., Bloomfield Village, MI (US) 48301

\* cited by examiner

(\*\*) Term: **14 Years**

*Primary Examiner*—Catherine R Oliver  
(74) *Attorney, Agent, or Firm*—Gifford, Krass, Sprinkle, Anderson & Citkowski, P.C.

(21) Appl. No.: **29/259,454**

(57) **CLAIM**

(22) Filed: **May 9, 2006**

The ornamental design for a portable electronic device carrier, as shown and described.

(51) **LOC (8) Cl.** ..... **03-01**

(52) **U.S. Cl.** ..... **D3/218**

(58) **Field of Classification Search** ..... D3/218,  
D3/215, 219, 201, 269, 230, 224, 226, 299;  
224/901, 904, 674, 676–681, 914, 240–241;  
206/320, 305; 383/10, 29, 42, 93, 95, 97  
See application file for complete search history.

**DESCRIPTION**

FIG. 1 is a front and right side perspective view of a portable electronic device carrier in a closed position;

FIG. 2 is a front view of the portable electronic device depicted in FIG. 1;

FIG. 3 is a top view of the portable electronic device carrier depicted in FIG. 1;

FIG. 4 is a left side planar view of the portable electronic device carrier depicted in FIG. 1;

FIG. 5 is a bottom view of the of the portable electronic device carrier depicted in FIG. 1; and,

FIG. 6 is a rear view of the portable electronic device carrier depicted in FIG. 1.

(56) **References Cited**

U.S. PATENT DOCUMENTS

2,400,626	A	5/1946	Brede	
5,351,868	A	10/1994	Beletsky et al.	
6,357,641	B1	3/2002	Cheng	
6,364,187	B1	4/2002	Castellano et al.	
6,367,672	B1	4/2002	Lind	
6,799,354	B1	10/2004	Goradesky	
D500,203	S *	12/2004	Kim	D3/218
D538,034	S *	3/2007	Moghaddam	D3/218

**1 Claim, 1 Drawing Sheet**

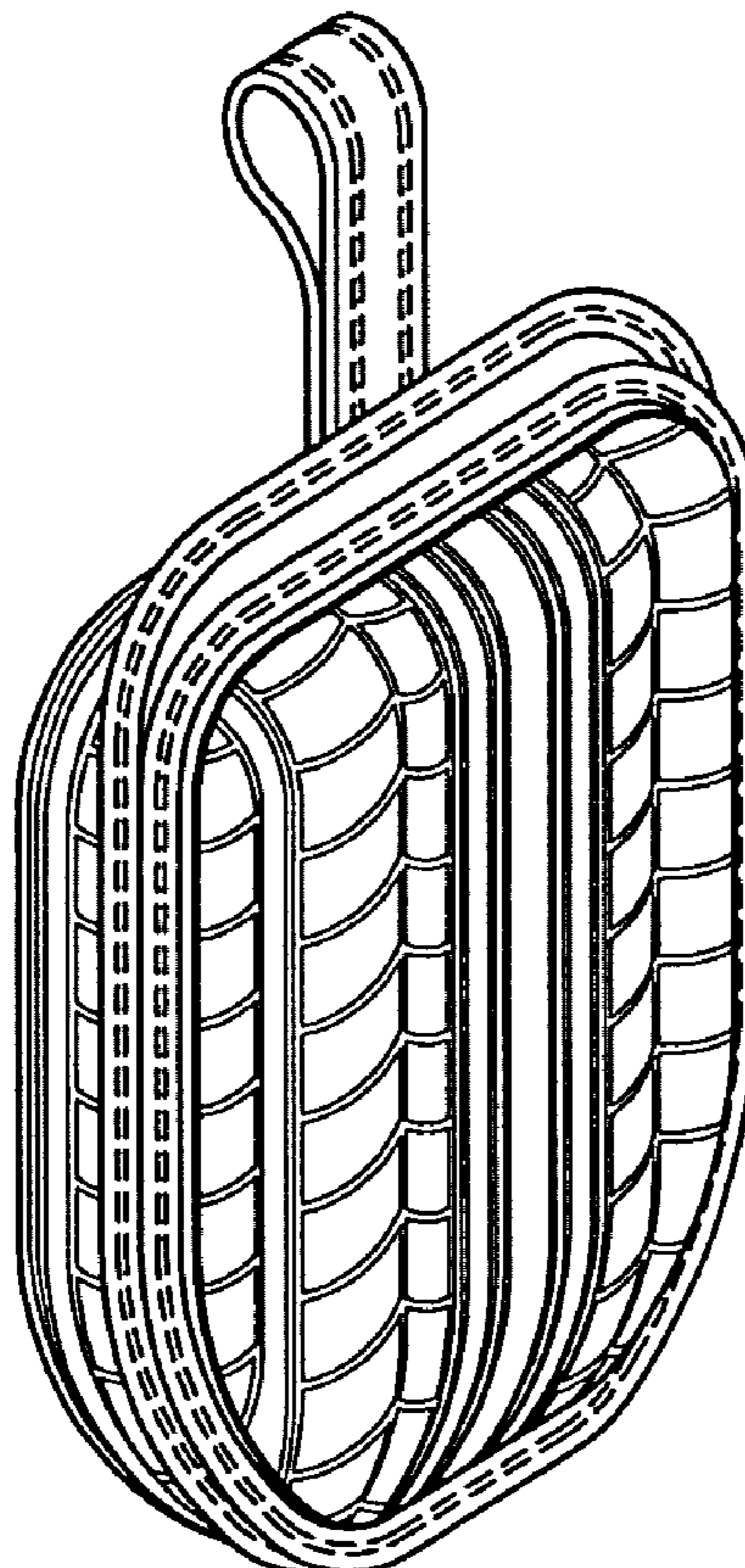

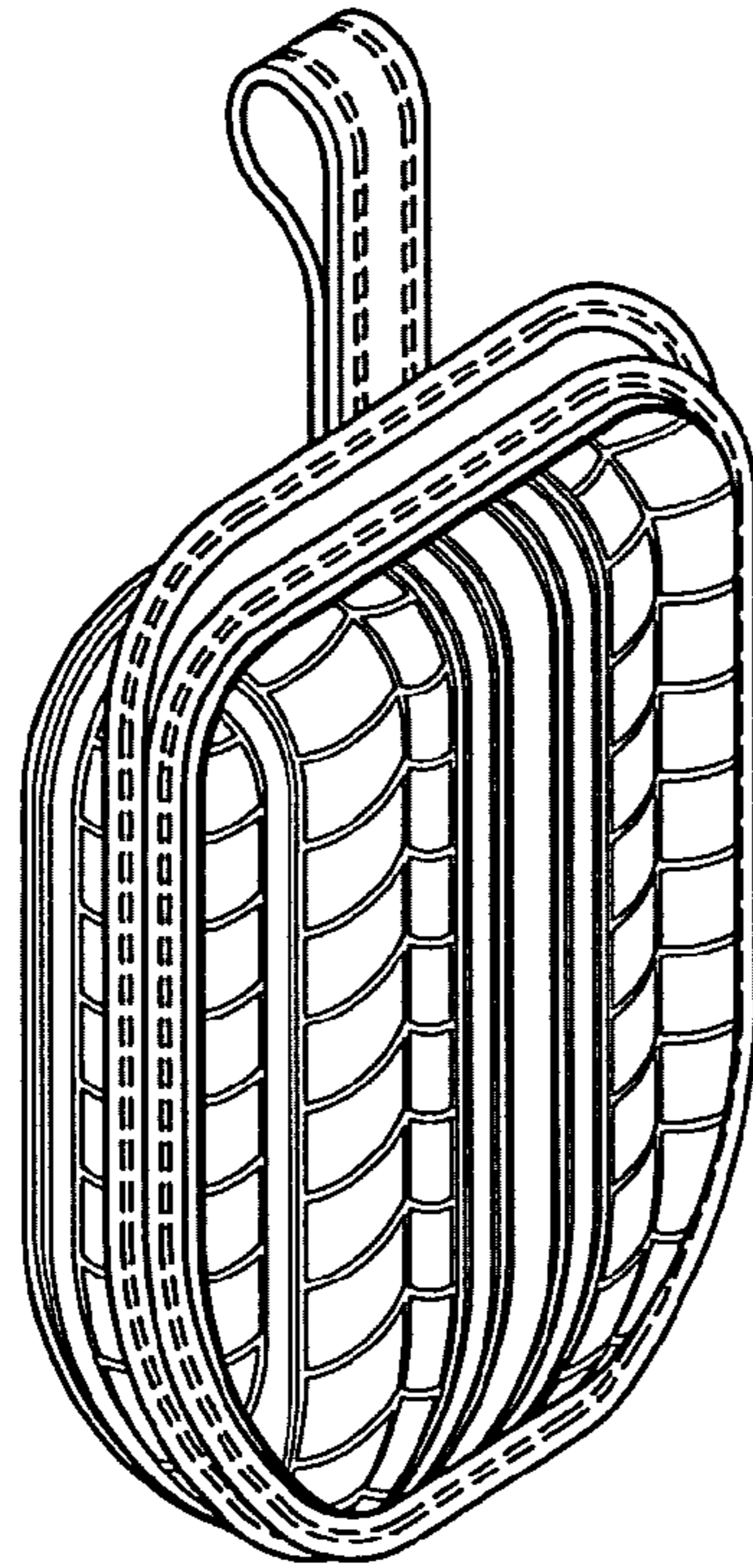

Figure 1

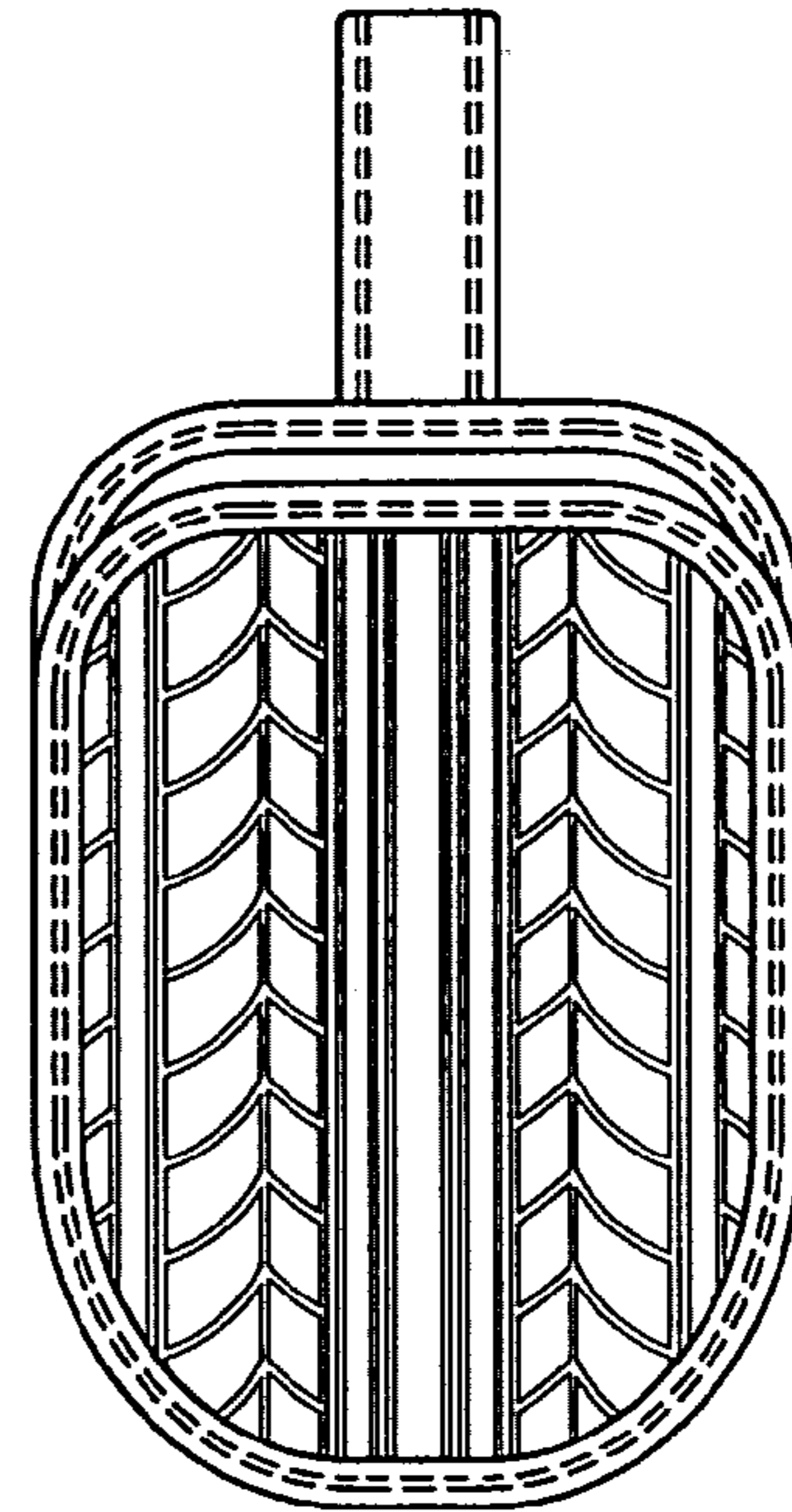

Figure 2

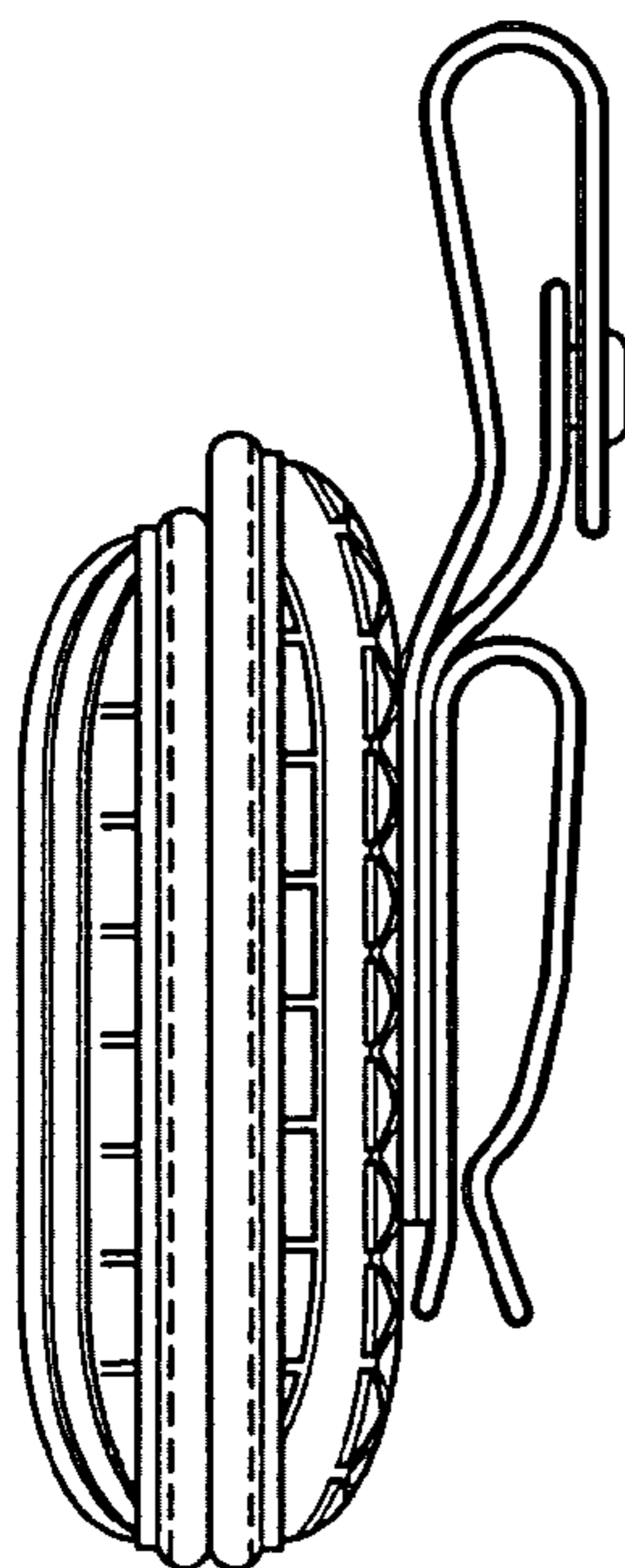

Figure 4

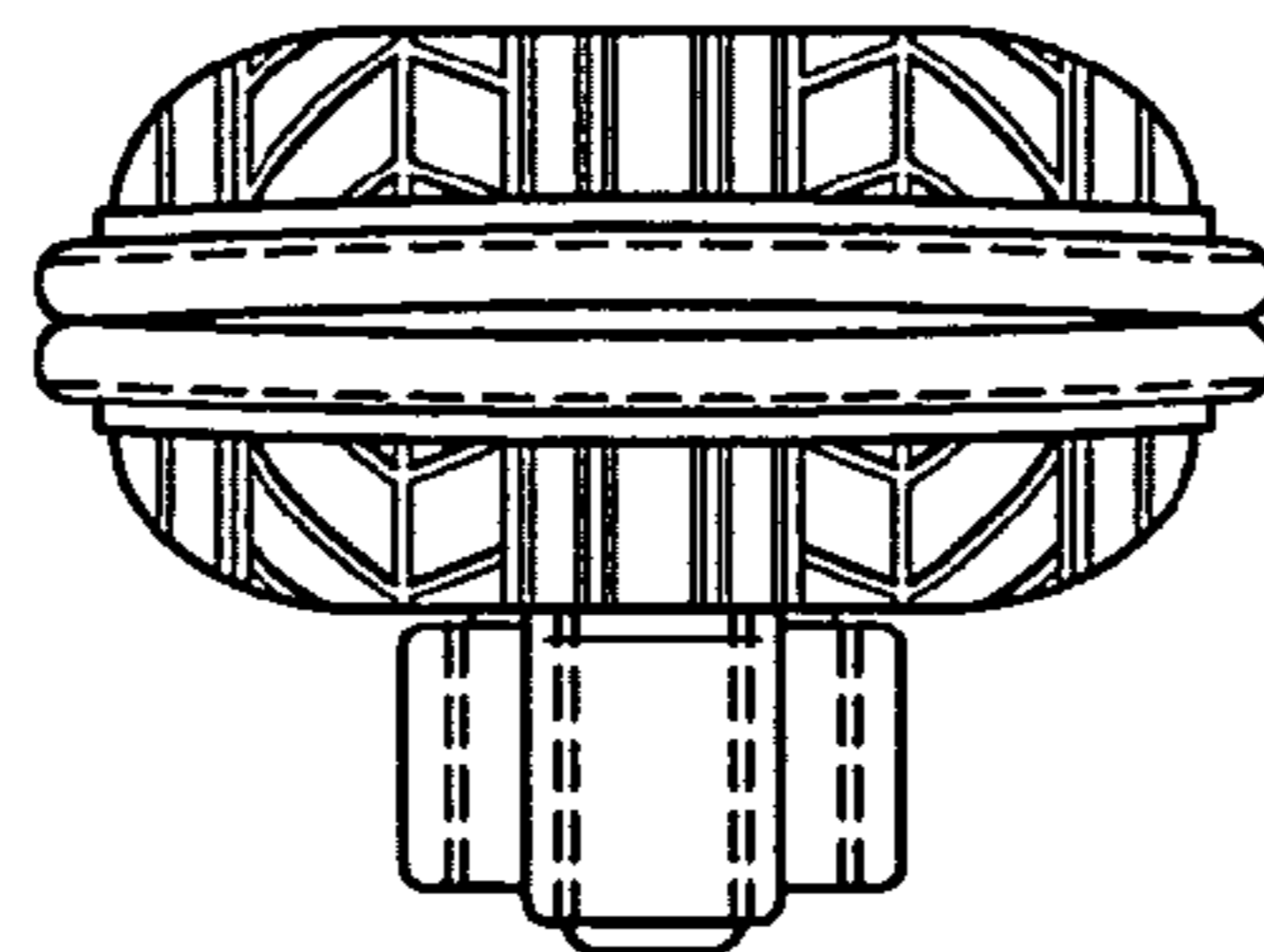

Figure 3

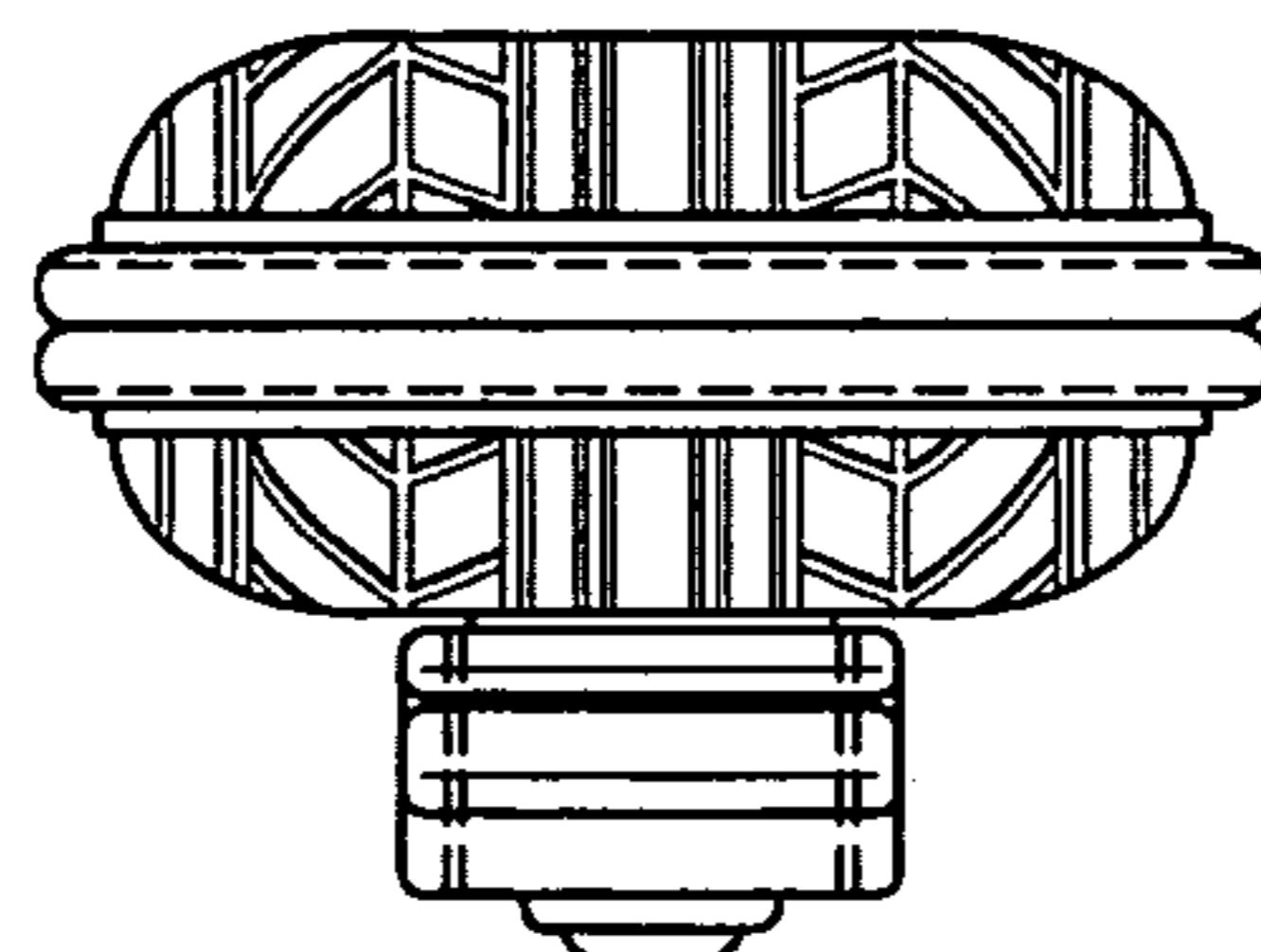

Figure 5

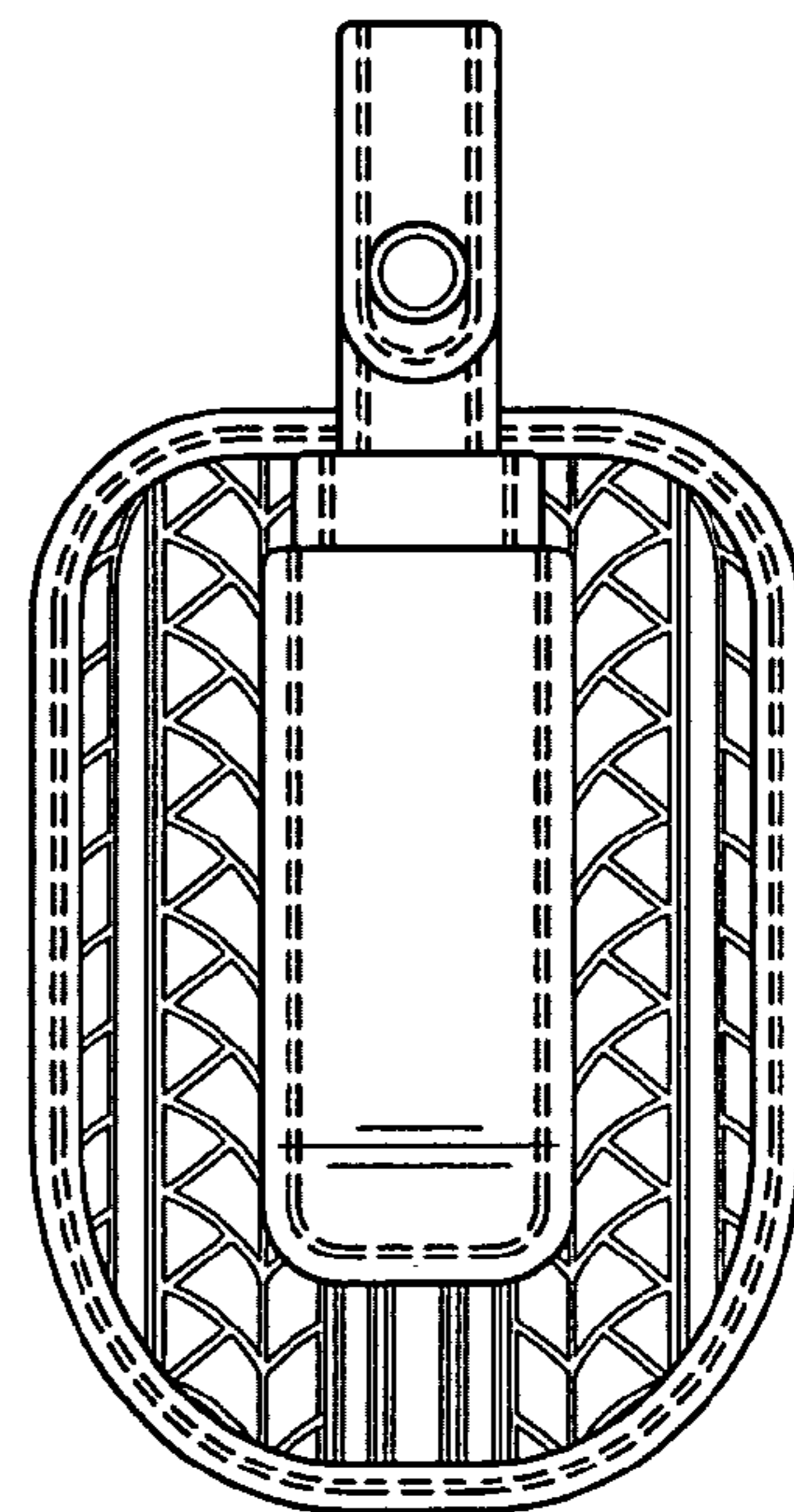

Figure 6