



US00D573761S

(12) **United States Design Patent**  
**Williams et al.**

(10) **Patent No.:** **US D573,761 S**  
(45) **Date of Patent:** **\*\* Jul. 22, 2008**

(54) **FLOOR CLEANING TOOL**

(75) Inventors: **Steve Williams**, Hayden Lake, ID (US);  
**Michael Genteman**, Liberty Lake, WA  
(US)

(73) Assignee: **USP Holding Corp.**, Coer D'Alene, ID  
(US)

(\*\*) Term: **14 Years**

(21) Appl. No.: **29/288,065**

(22) Filed: **May 29, 2007**

(51) **LOC (8) Cl.** ..... **15-05**

(52) **U.S. Cl.** ..... **D32/25**

(58) **Field of Classification Search** ..... D32/31-33,  
D32/1, 21, 25, 50; D23/213; 15/321-322,  
15/353, 320, 420, 1.7, 344; 134/198; 68/5 R  
See application file for complete search history.

(56) **References Cited**

U.S. PATENT DOCUMENTS

832,866	A *	10/1906	Lorentz	.....	210/238
D215,875	S *	11/1969	Hoadley	.....	D32/32
3,962,745	A *	6/1976	Collier	.....	15/322
D242,212	S *	11/1976	Parise	.....	D32/32
D264,139	S *	4/1982	Pearman, Jr.	.....	D32/33
4,334,336	A *	6/1982	Harbeck et al.	.....	15/322
4,654,925	A *	4/1987	Grave	.....	15/322
D306,788	S *	3/1990	McAllister et al.	.....	D32/32

5,157,805	A *	10/1992	Pinter	.....	15/322
5,485,652	A *	1/1996	Holland	.....	15/322
6,560,818	B1 *	5/2003	Hasko	.....	15/321
2003/0046788	A1 *	3/2003	Kent et al.	.....	15/320

\* cited by examiner

*Primary Examiner*—Louis S Zarfaz

*Assistant Examiner*—Kathleen M Sims

(74) *Attorney, Agent, or Firm*—Wells St. John P.S.

(57) **CLAIM**

The ornamental design for a floor cleaning tool, as shown and described.

**DESCRIPTION**

FIG. 1 is a bottom perspective view of a floor cleaning tool showing our new design;

FIG. 2 is a bottom plan view thereof;

FIG. 3 is a top plan view thereof;

FIG. 4 is a side elevation view thereof;

FIG. 5 is an opposite side elevation view thereof;

FIG. 6 is a top view thereof; and,

FIG. 7 is a bottom front view thereof.

The broken line showing of details in FIGS. 1-7 is included for the purpose of illustrating portions of the floor cleaning tool that form no part of the claimed design.

**1 Claim, 7 Drawing Sheets**

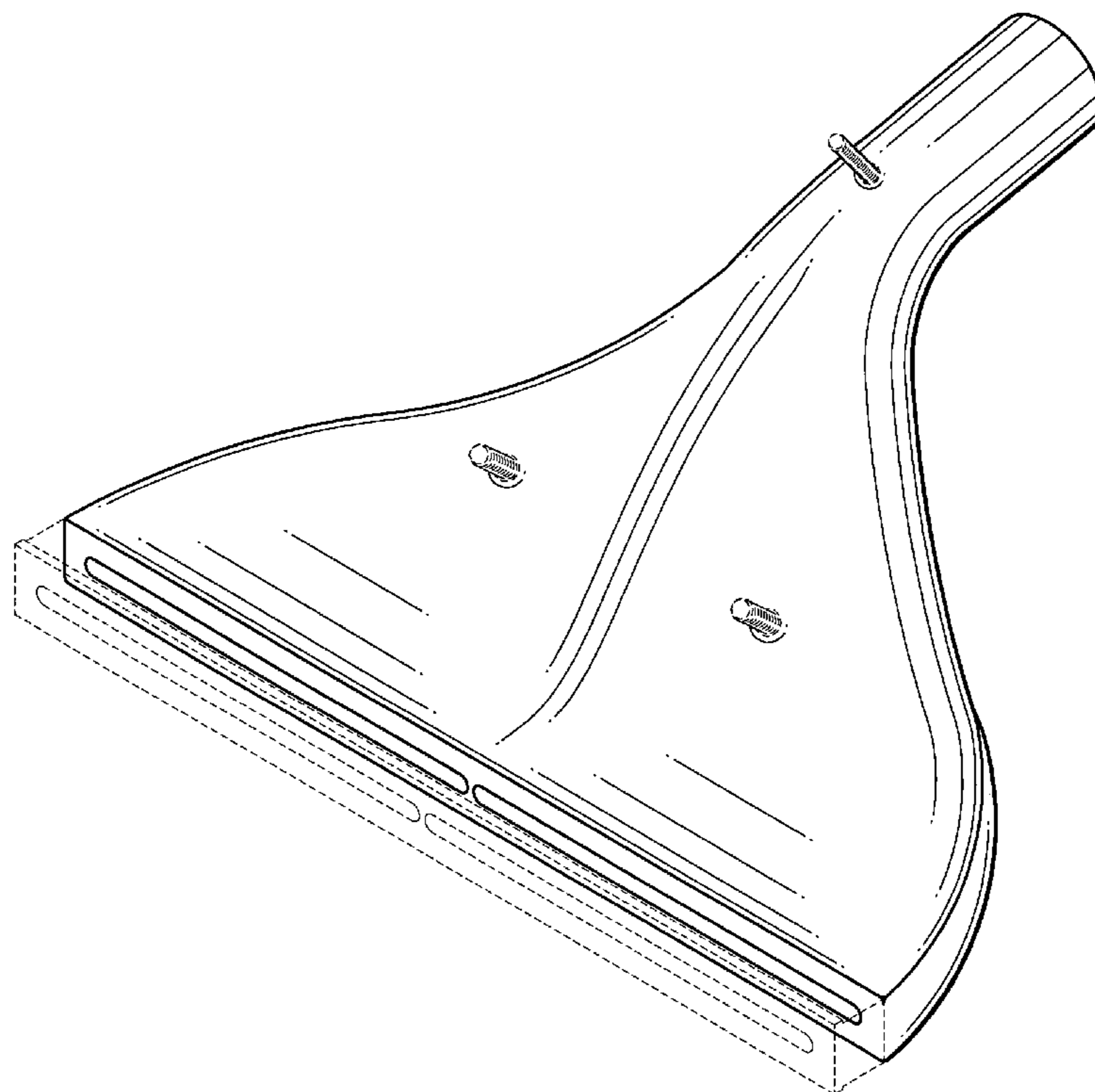

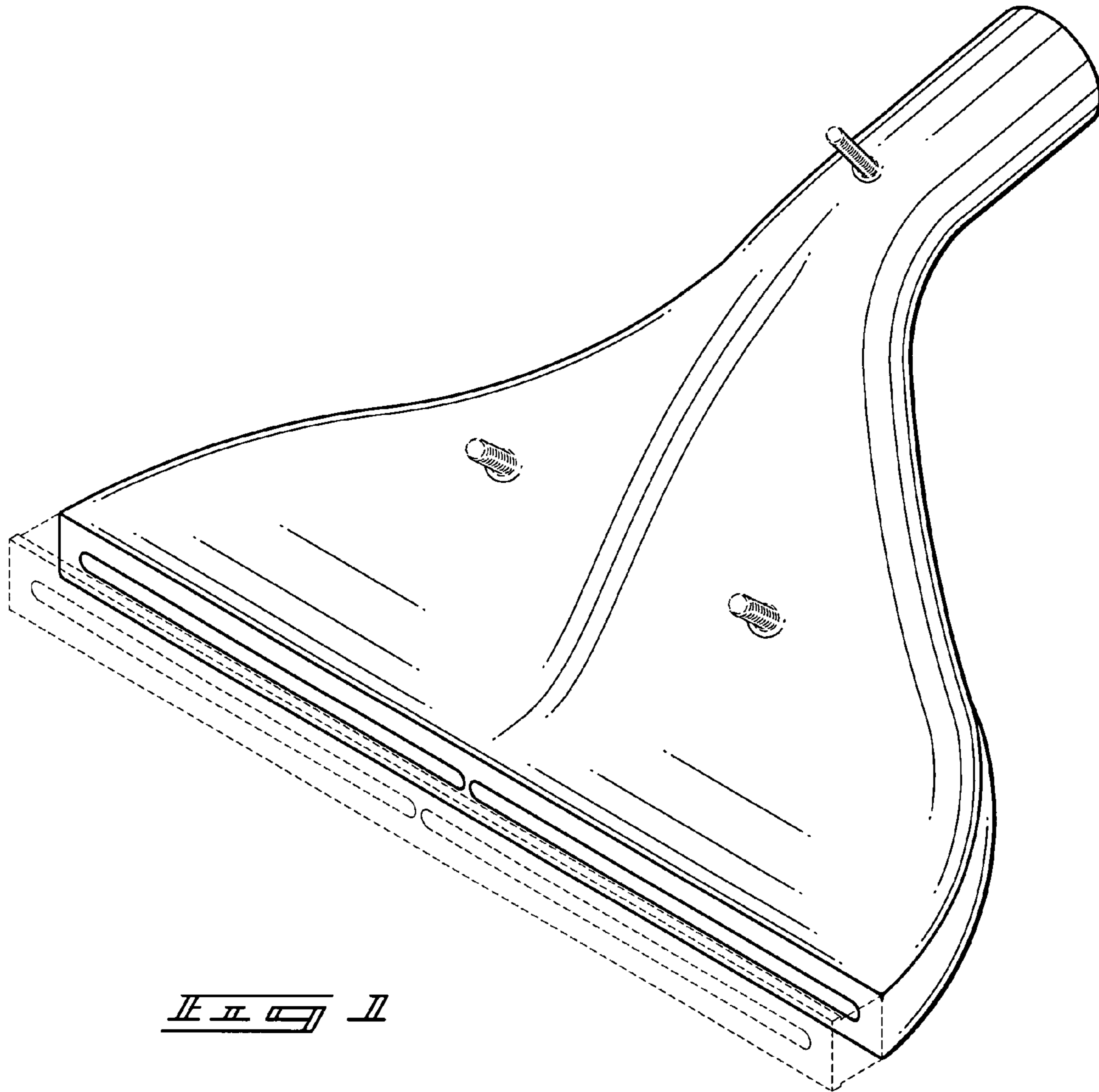

II II II

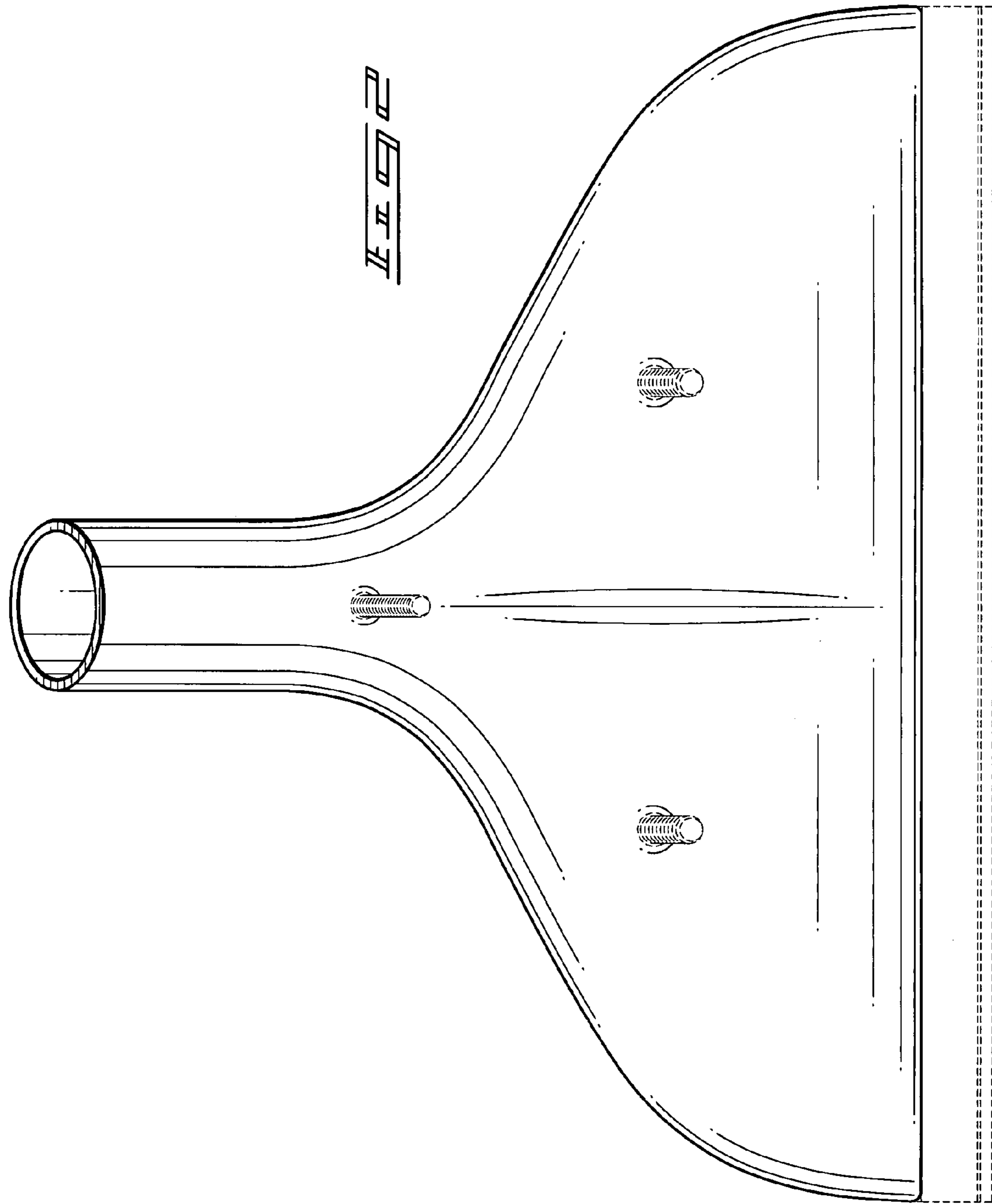

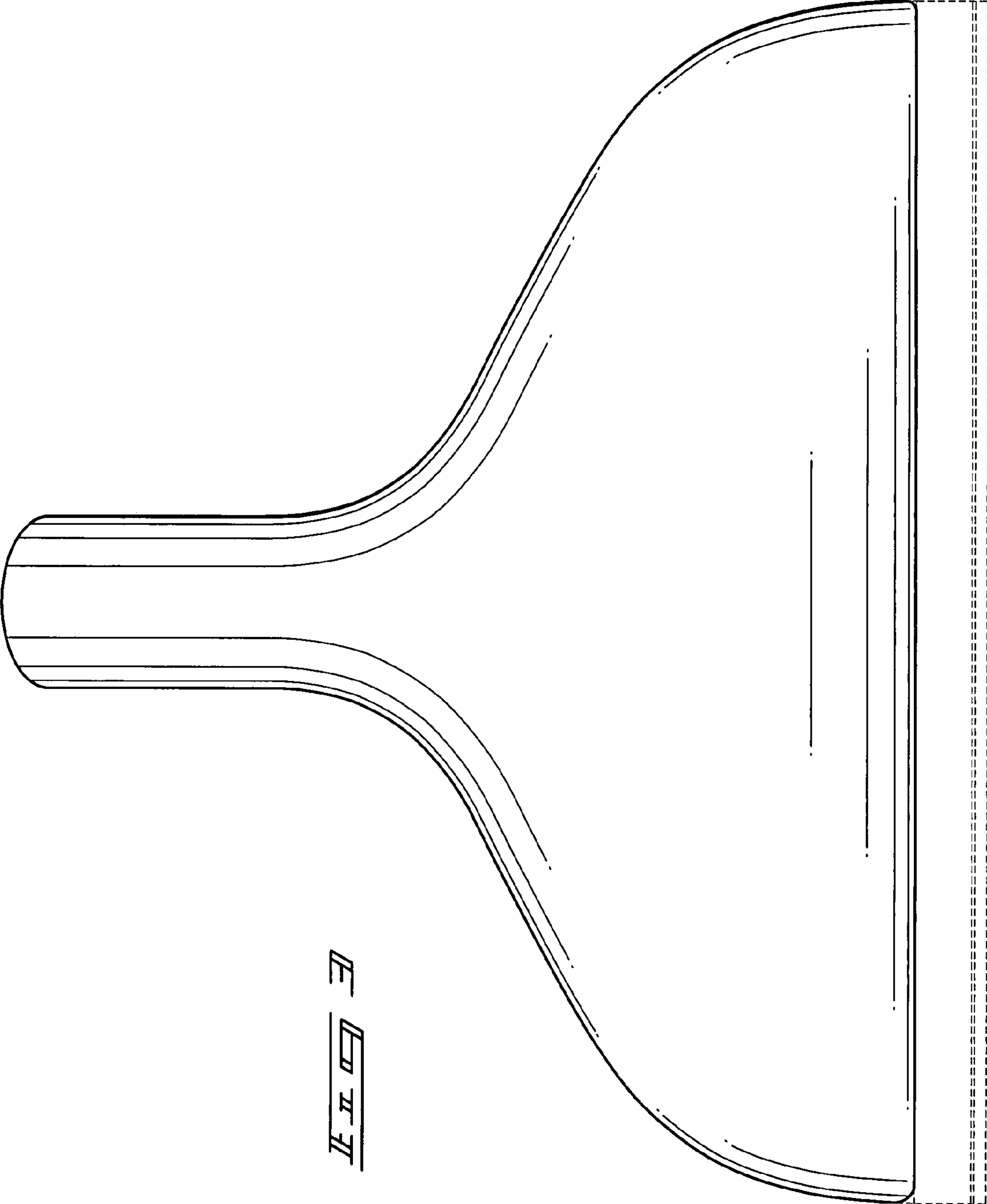

*EST*

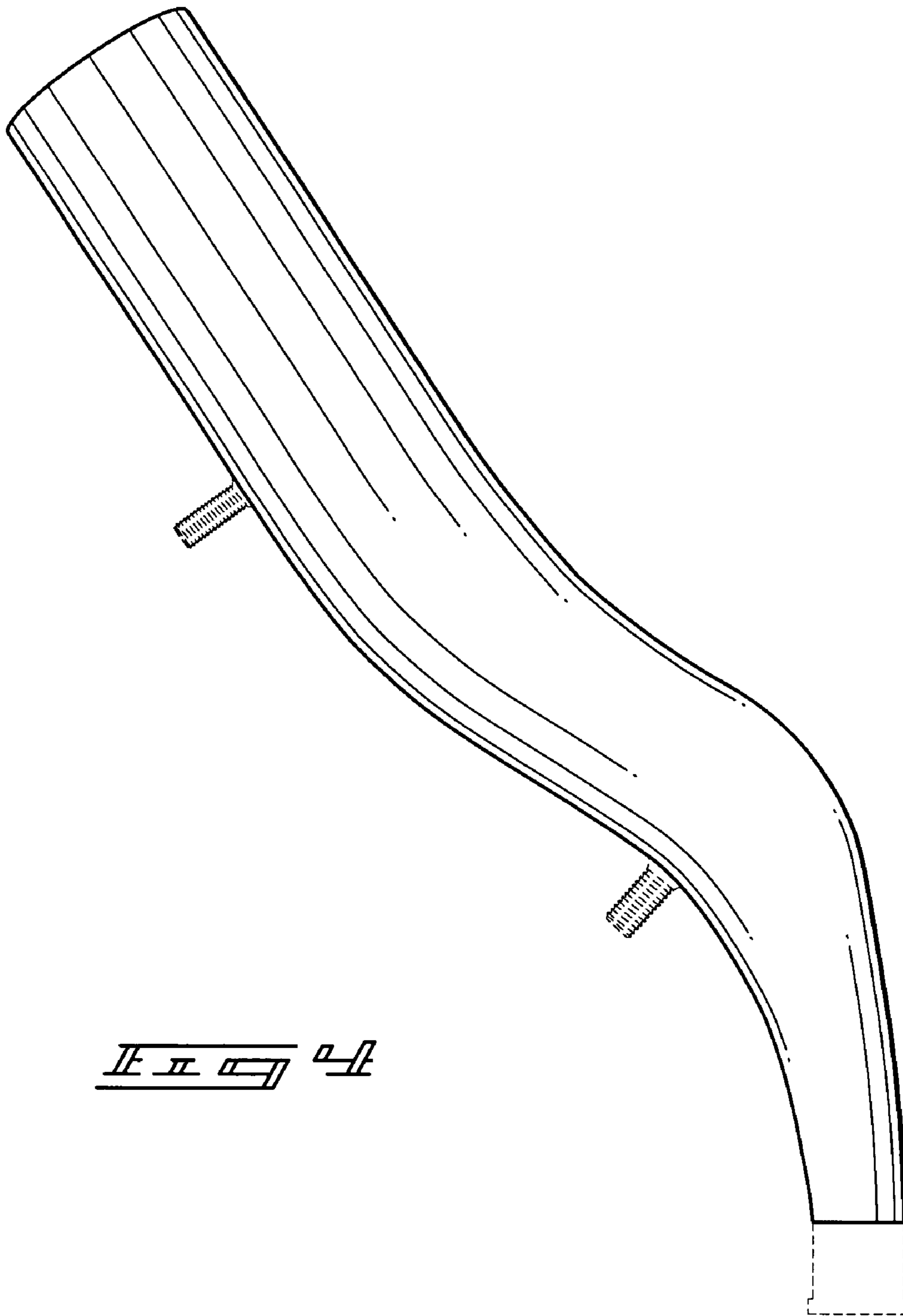

*Fig. 4*

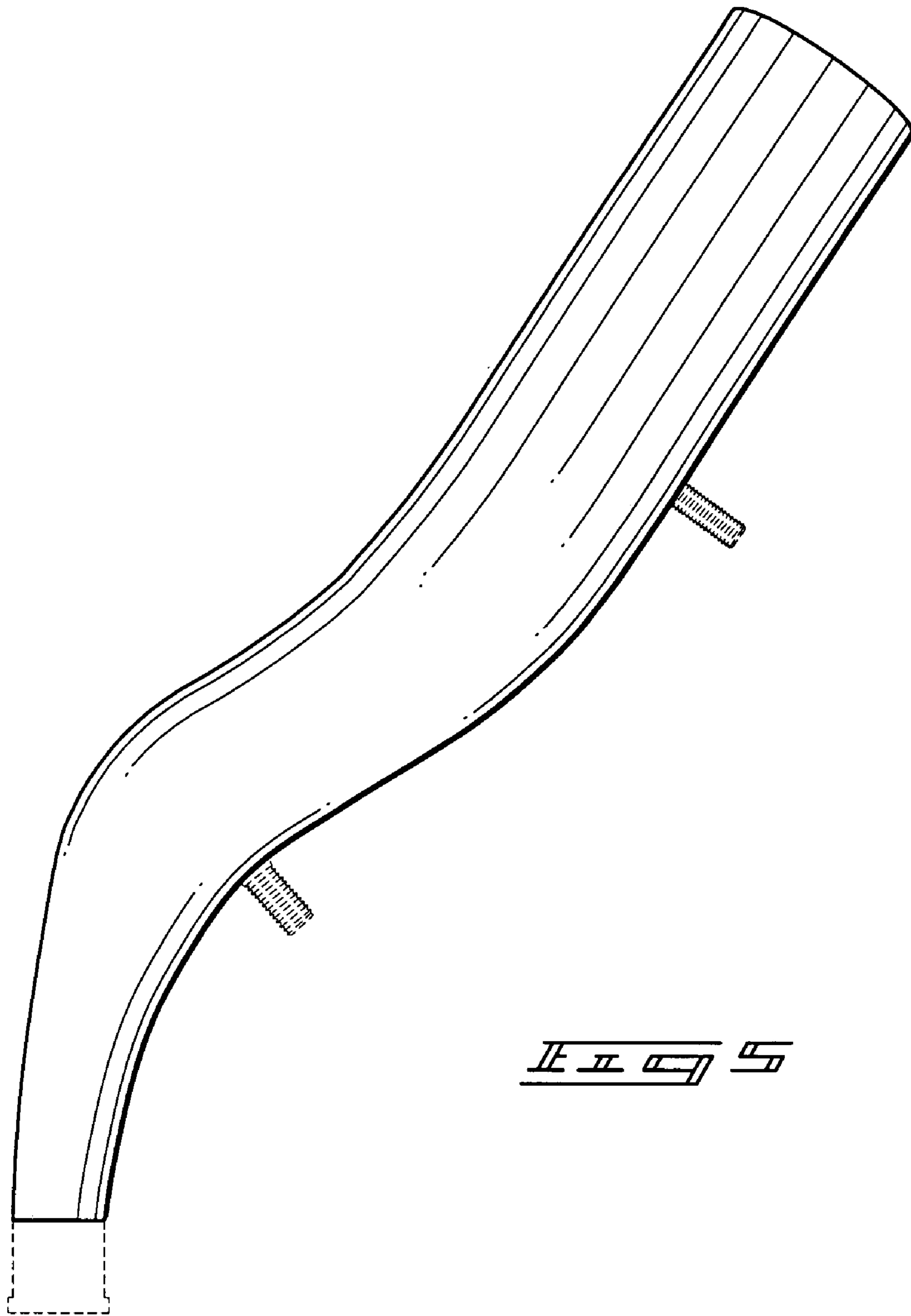

FIG. 5

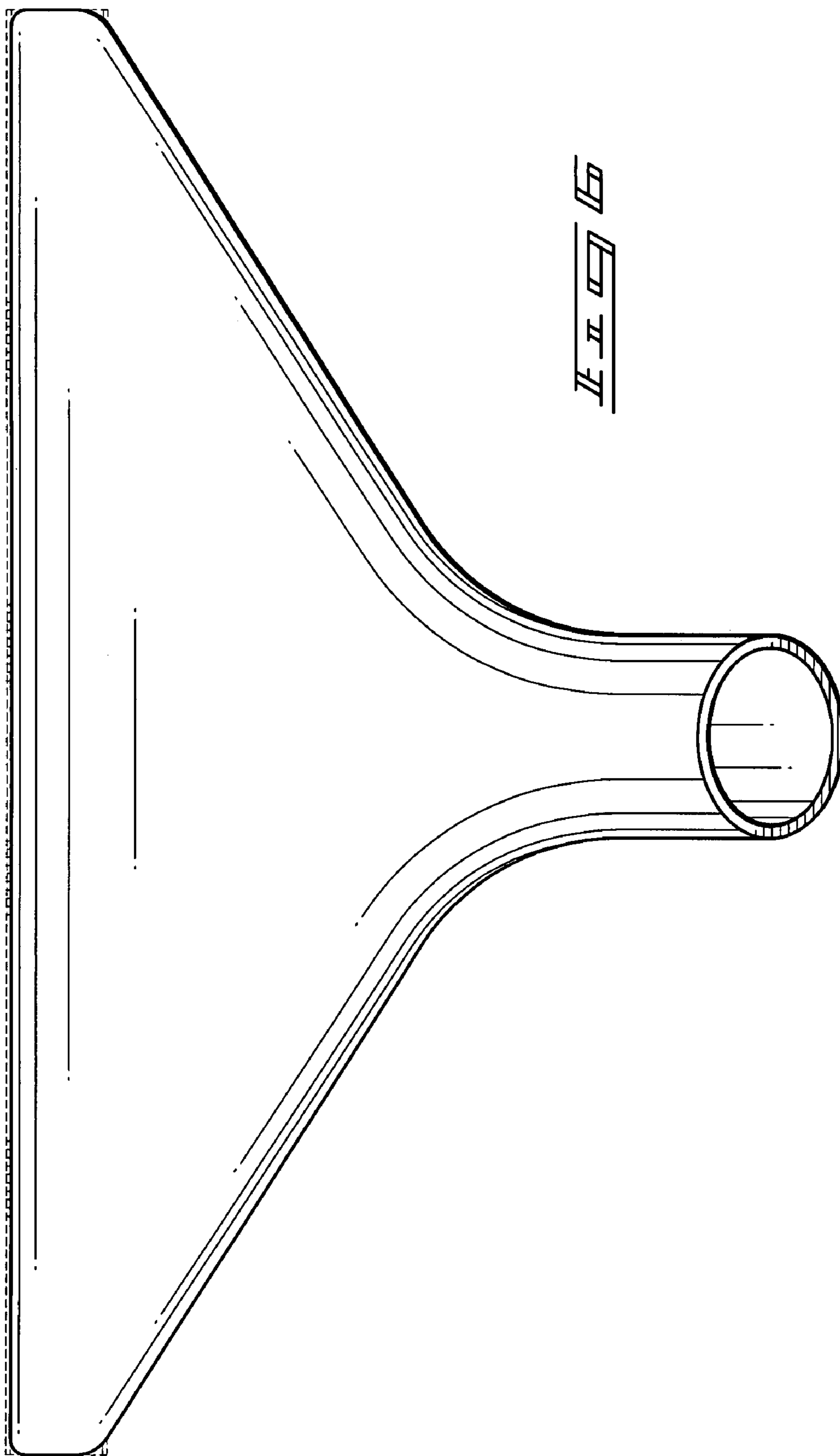

FIG. 6

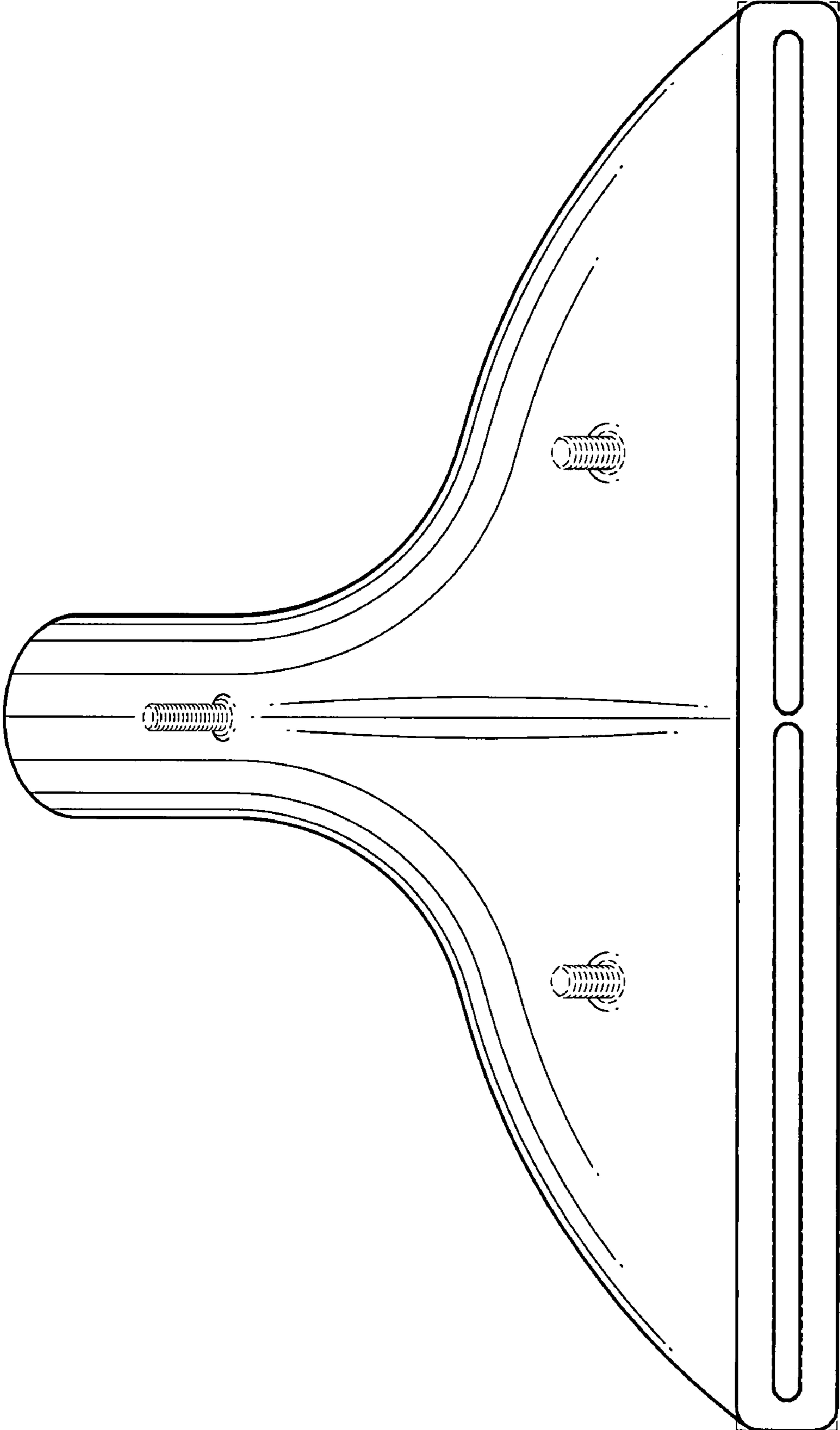

FIG. 7