



US00D573745S

(12) **United States Design Patent**
Engel

(10) **Patent No.:** **US D573,745 S**

(45) **Date of Patent:** **** *Jul. 22, 2008**

(54) **LAMP**

(76) Inventor: **Hartmut S. Engel**, Monrepos Strasse 7,
Ludwigsburg (DE) 71634

(*) Notice: This patent is subject to a terminal disclaimer.

(**) Term: **14 Years**

(21) Appl. No.: **29/255,369**

(22) Filed: **Mar. 6, 2006**

(51) **LOC (8) Cl.** **26-03**

(52) **U.S. Cl.** **D26/76**

(58) **Field of Classification Search** D26/72,
D26/74-79, 86, 85, 108, 118; 362/217-225,
362/283, 147, 145, 347, 260-267, 269, 368,
362/373, 805-807

See application file for complete search history.

(56) **References Cited**

U.S. PATENT DOCUMENTS

D360,271 S *	7/1995	Butler	D26/77
D405,208 S *	2/1999	Walz	D26/86
D405,209 S *	2/1999	Walz	D26/86
D435,310 S *	12/2000	Herst et al.	D26/76
6,210,025 B1 *	4/2001	Schmidt et al.	362/362
D441,891 S *	5/2001	Herst et al.	D26/76

D463,879 S *	10/2002	Mier-Langner et al.	D26/77
D480,494 S *	10/2003	Targetti	D26/72
D485,932 S *	1/2004	Crane	D26/76
D496,123 S *	9/2004	Blackman	D26/76

* cited by examiner

Primary Examiner—Robert M. Spear
Assistant Examiner—Susan E Krakower
(74) *Attorney, Agent, or Firm*—Lewis and Roca LLP

(57) **CLAIM**

The ornamental design for a lamp, as shown and described.

DESCRIPTION

FIG. 1 is a side top perspective view of a lamp in accordance with this invention;

FIG. 2 is a side elevation view thereof;

FIG. 3 is a top plan view thereof;

FIG. 4 is an enlarged top end perspective view thereof;

FIG. 5 is an enlarged end elevation view thereof;

FIG. 6 is a bottom plan view thereof; and,

FIG. 7 is a bottom perspective thereof.

The broken lines in the drawings represent environmental structure and form no part of the claimed design.

1 Claim, 5 Drawing Sheets

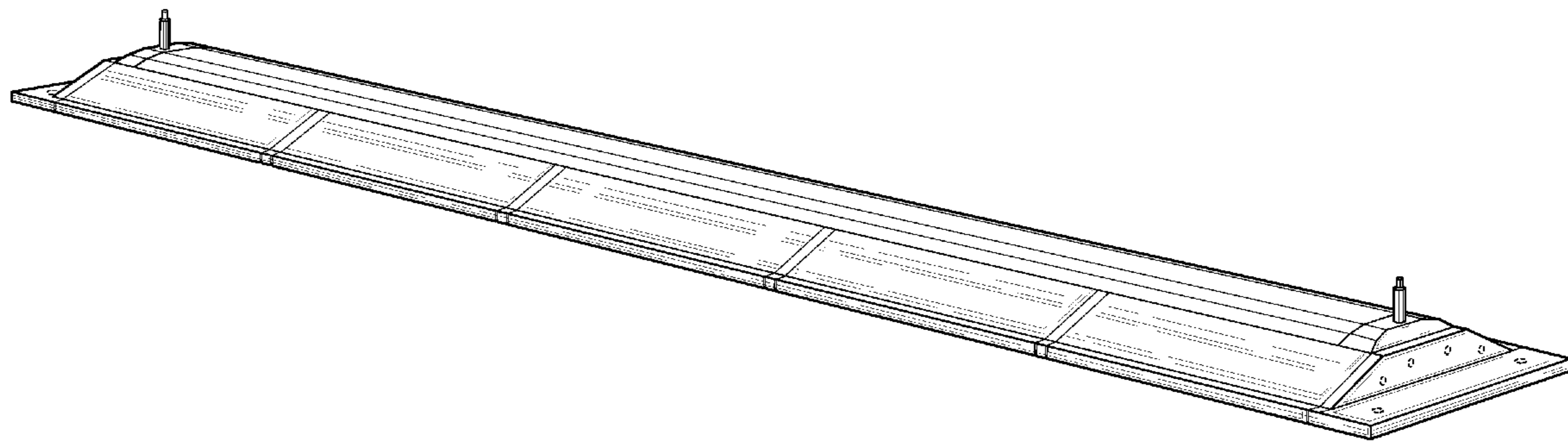

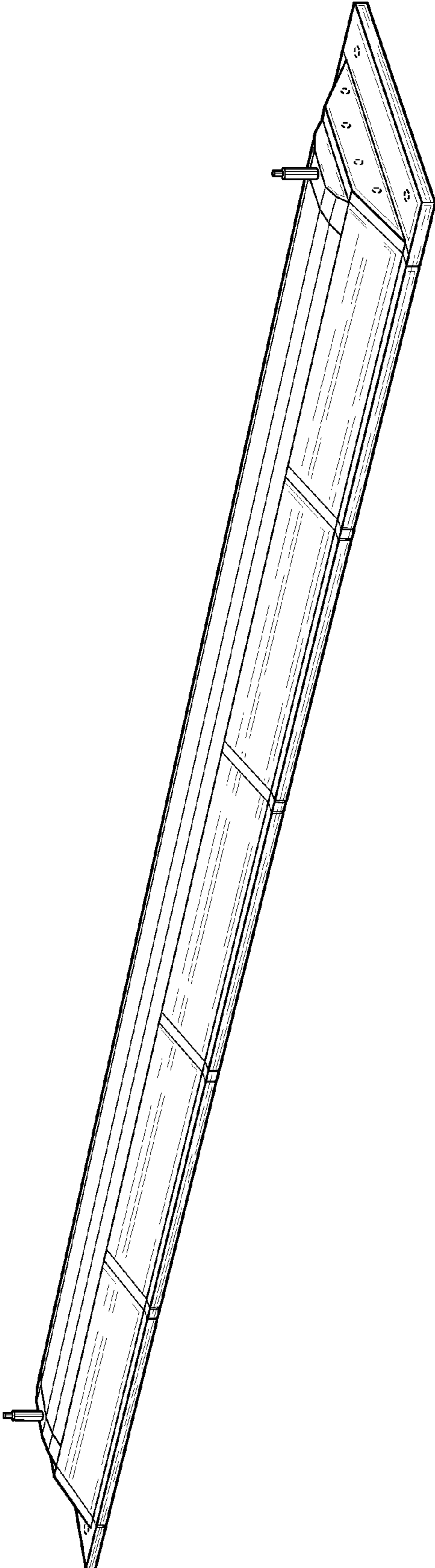

Fig. 1

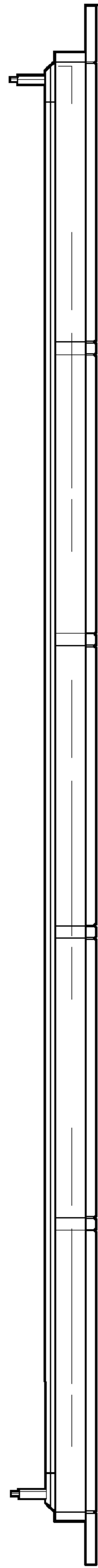

Fig. 2

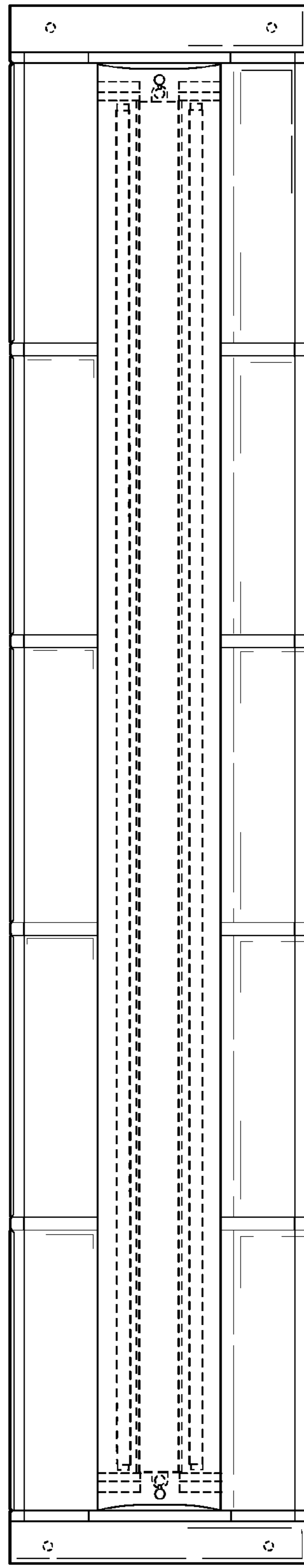

Fig. 3

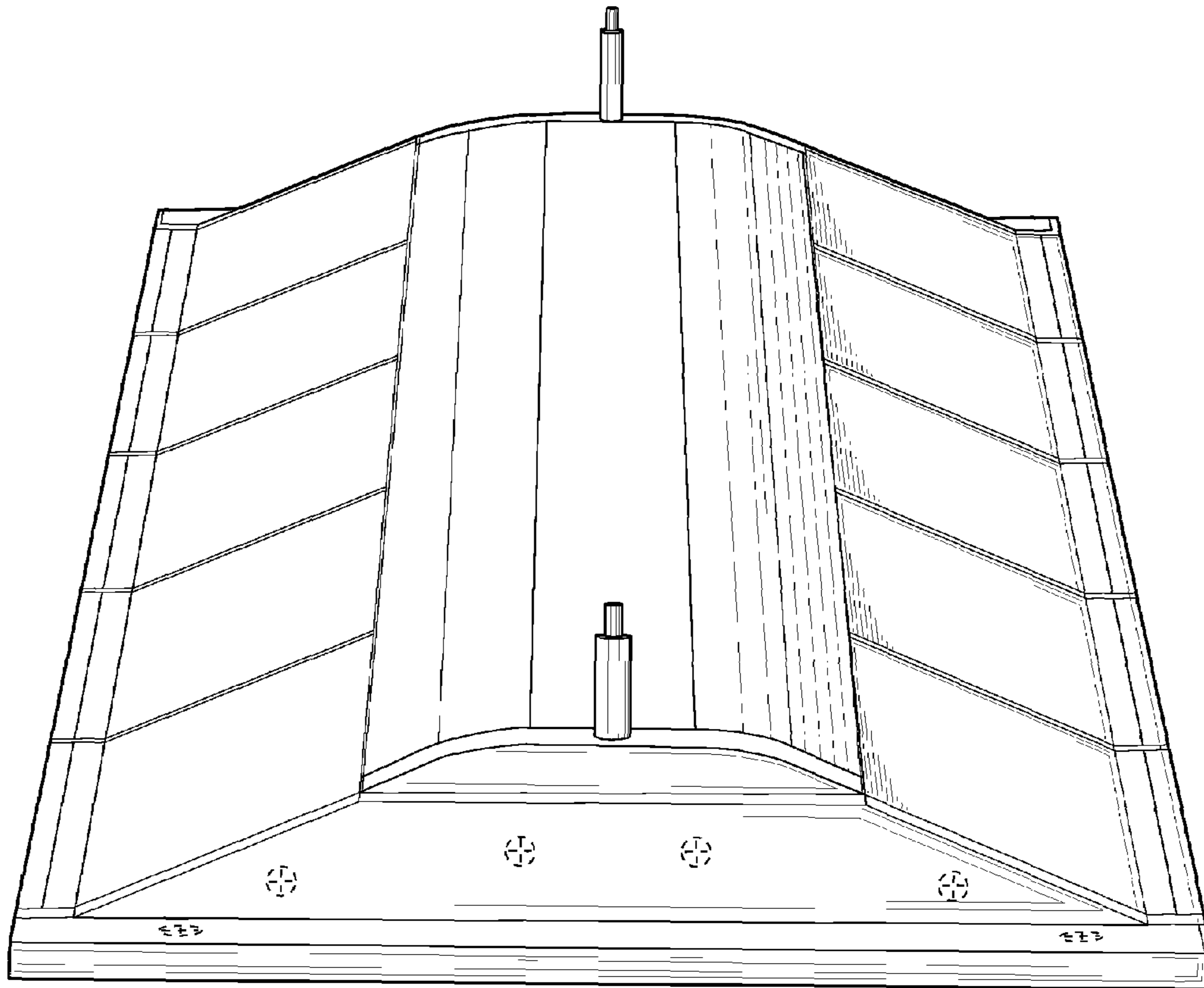

Fig. 4

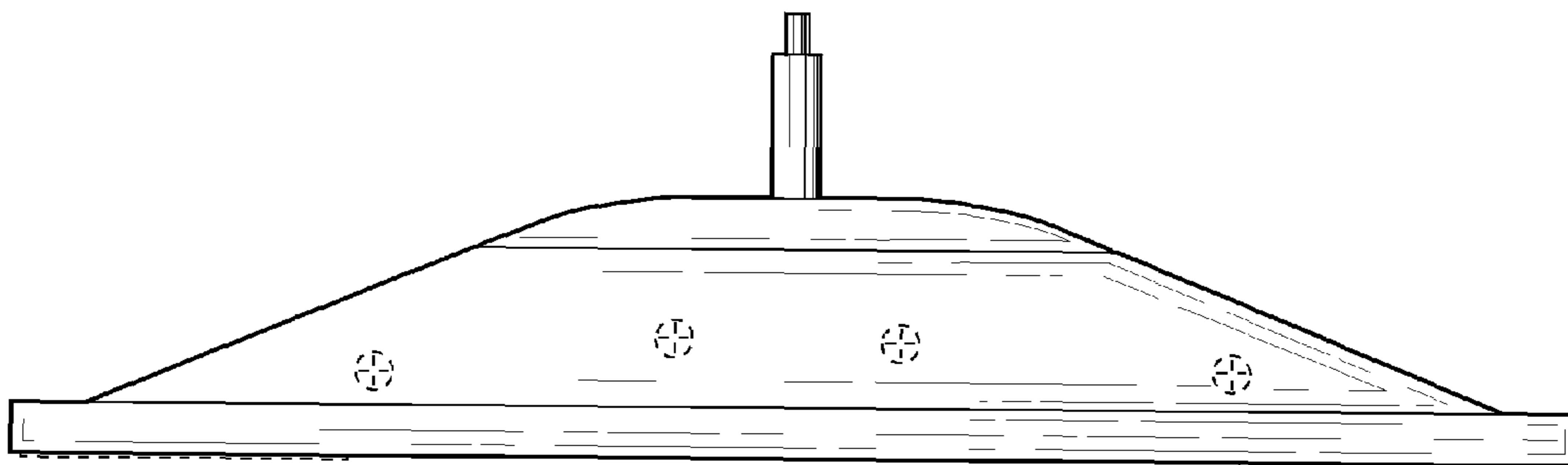

Fig. 5

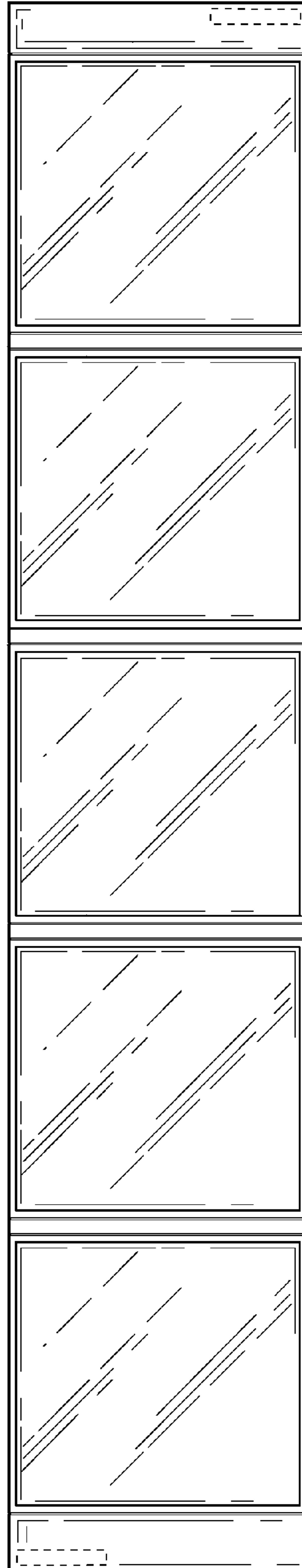

Fig. 6

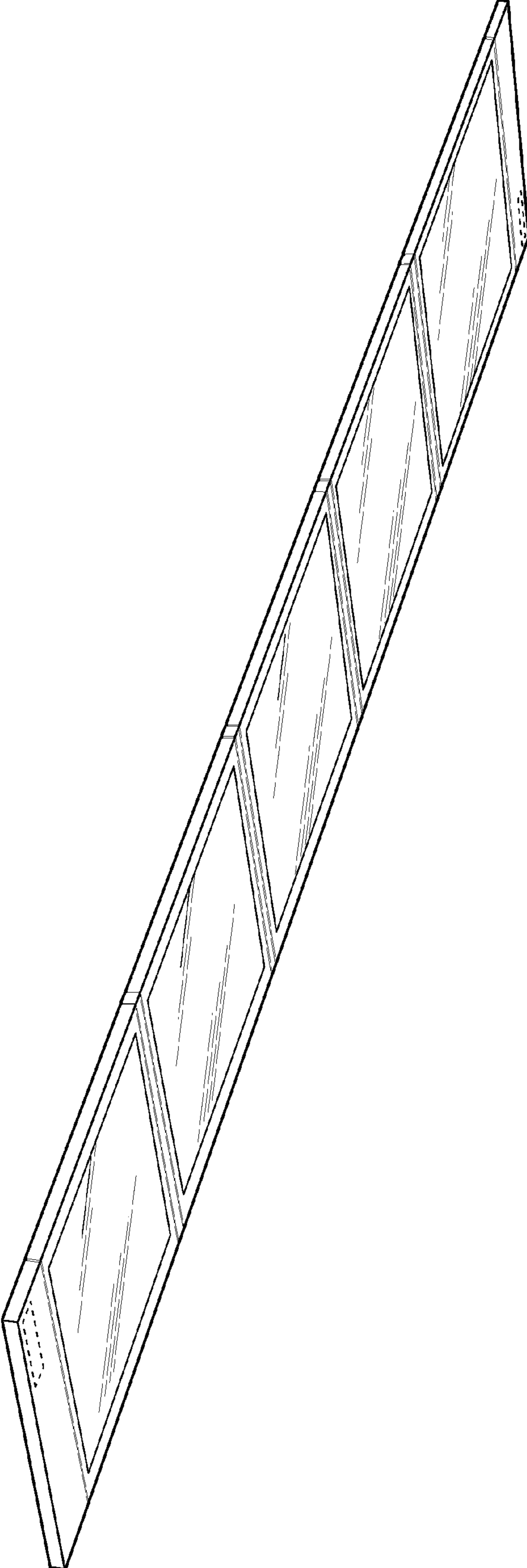

Fig. 7