



US00D573684S

(12) **United States Design Patent**  
**Asano et al.**

(10) **Patent No.:** **US D573,684 S**  
(45) **Date of Patent:** **\*\* Jul. 22, 2008**

(54) **OPERATION LEVER OF FISHING REEL BODY**

(75) Inventors: **Shinichi Asano**, Musashino (JP); **Akio Sekimoto**, Higashikurume (JP); **Wataru Tsutsumi**, Higashikurume (JP)

(73) Assignee: **Daiwa Seiko, Inc.**, Tokyo (JP)

(\*\*) Term: **14 Years**

(21) Appl. No.: **29/295,982**

(22) Filed: **Oct. 11, 2007**

(30) **Foreign Application Priority Data**

Apr. 13, 2007 (JP) ..... 2007-009988

(51) **LOC (8) Cl.** ..... **22-05**

(52) **U.S. Cl.** ..... **D22/141**

(58) **Field of Classification Search** ..... D22/140,  
D22/141, 137-139; 242/234-240, 310-319,  
242/322; 43/19-22

See application file for complete search history.

(56) **References Cited**

**U.S. PATENT DOCUMENTS**

- D366,690 S \* 1/1996 Storz ..... D22/140
- D367,515 S \* 2/1996 Robbins et al. .... D22/140
- D425,169 S \* 5/2000 Iwabuchi ..... D22/140
- D432,202 S \* 10/2000 Kim et al. .... D22/140

\* cited by examiner

*Primary Examiner*—Catherine R Oliver  
(74) *Attorney, Agent, or Firm*—Sughrue Mion, PLLC

(57) **CLAIM**

The ornamental design for an operation lever of fishing reel body, as shown and described.

**DESCRIPTION**

FIG. 1 is a perspective view of the top, front, and left side of an operative lever of fishing reel body showing our new design;

FIG. 2 is a perspective view of the top, rear, and left side thereof;

FIG. 3 is a front elevational view thereof;

FIG. 4 is a rear elevational view thereof;

FIG. 5 is a top plan view thereof;

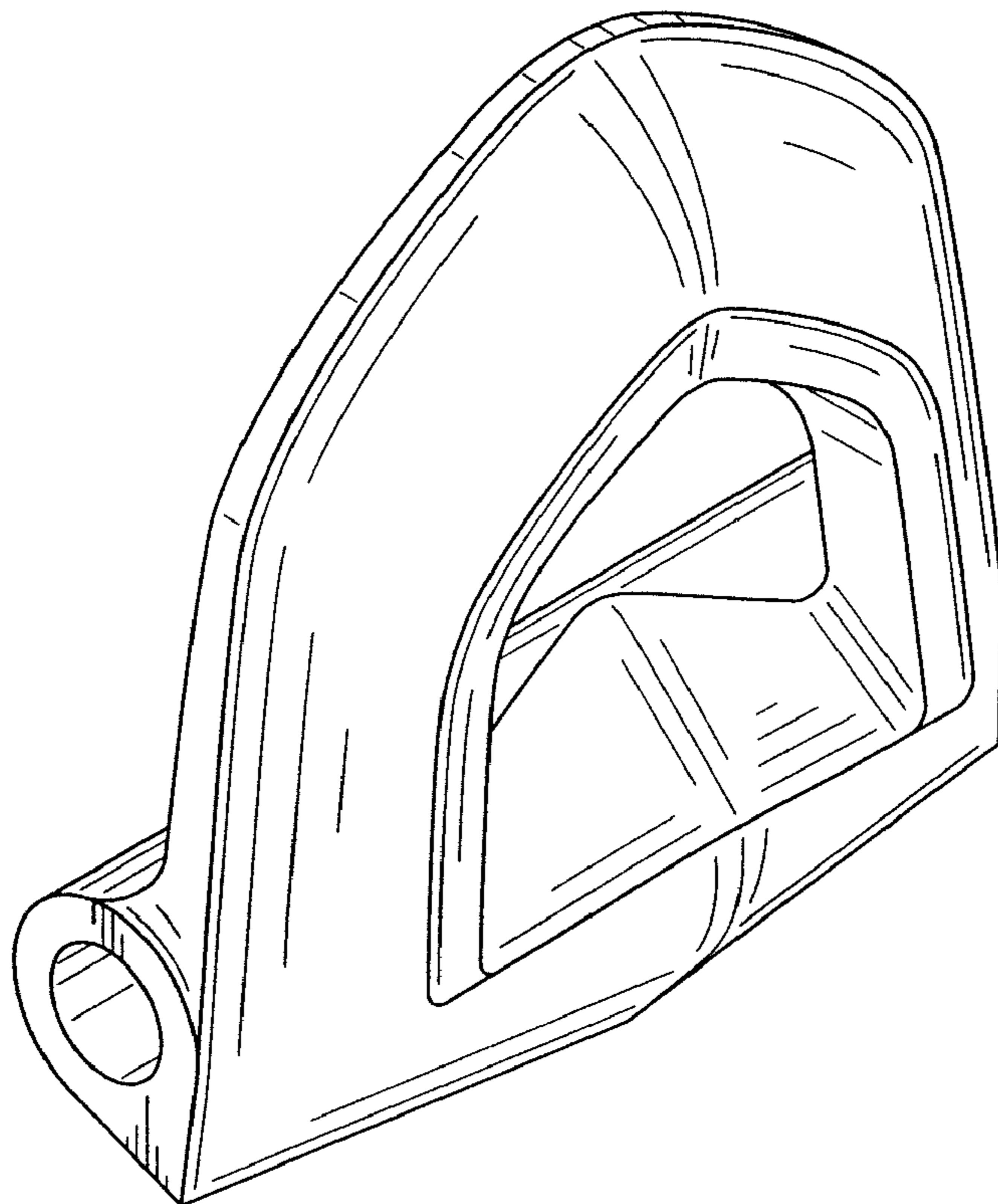
FIG. 6 is a bottom plan view thereof;

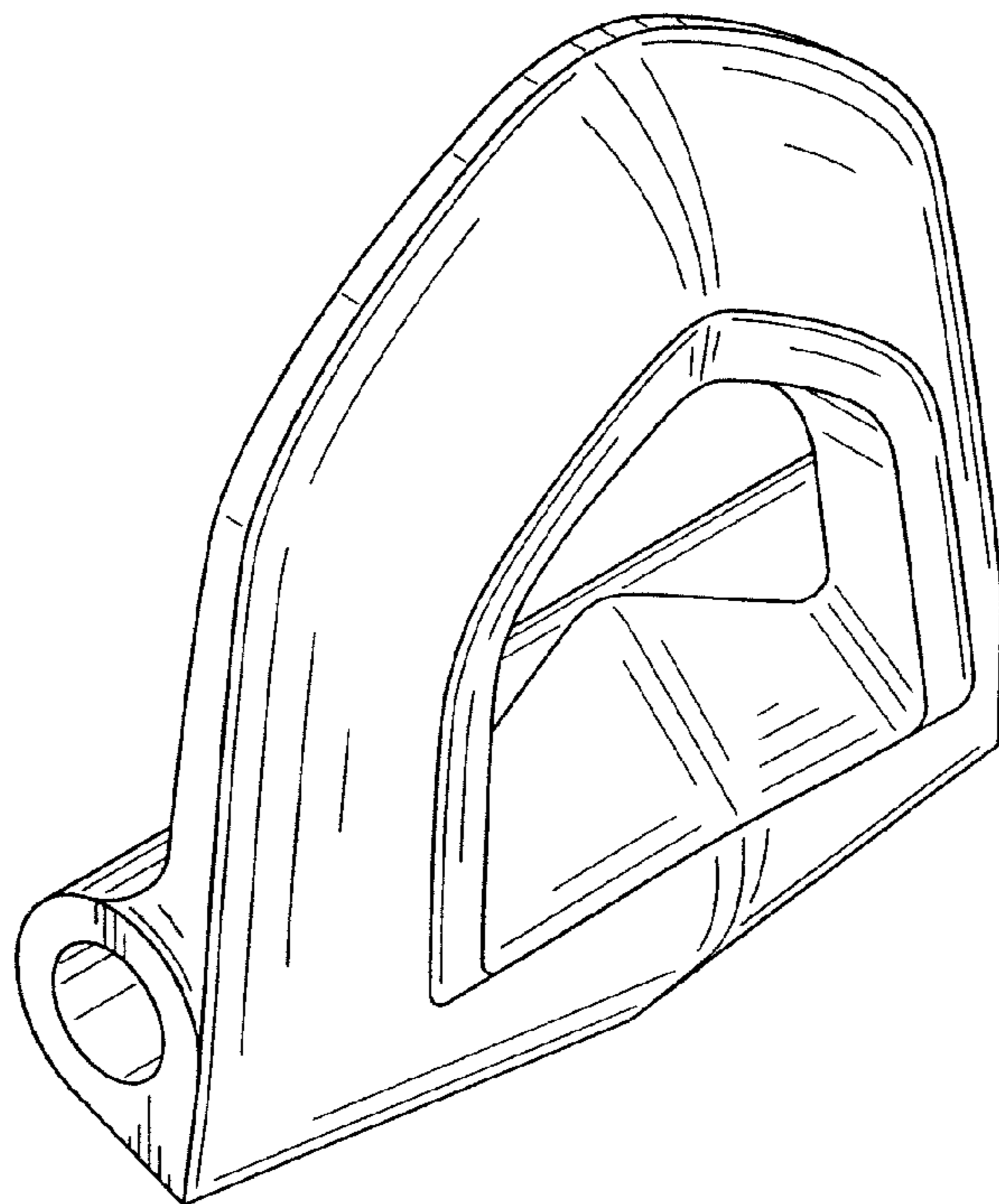
FIG. 7 is a right side elevational view thereof; the left side being a mirror image; and,

FIG. 8 is a perspective view thereof while in use on a fishing reel body.

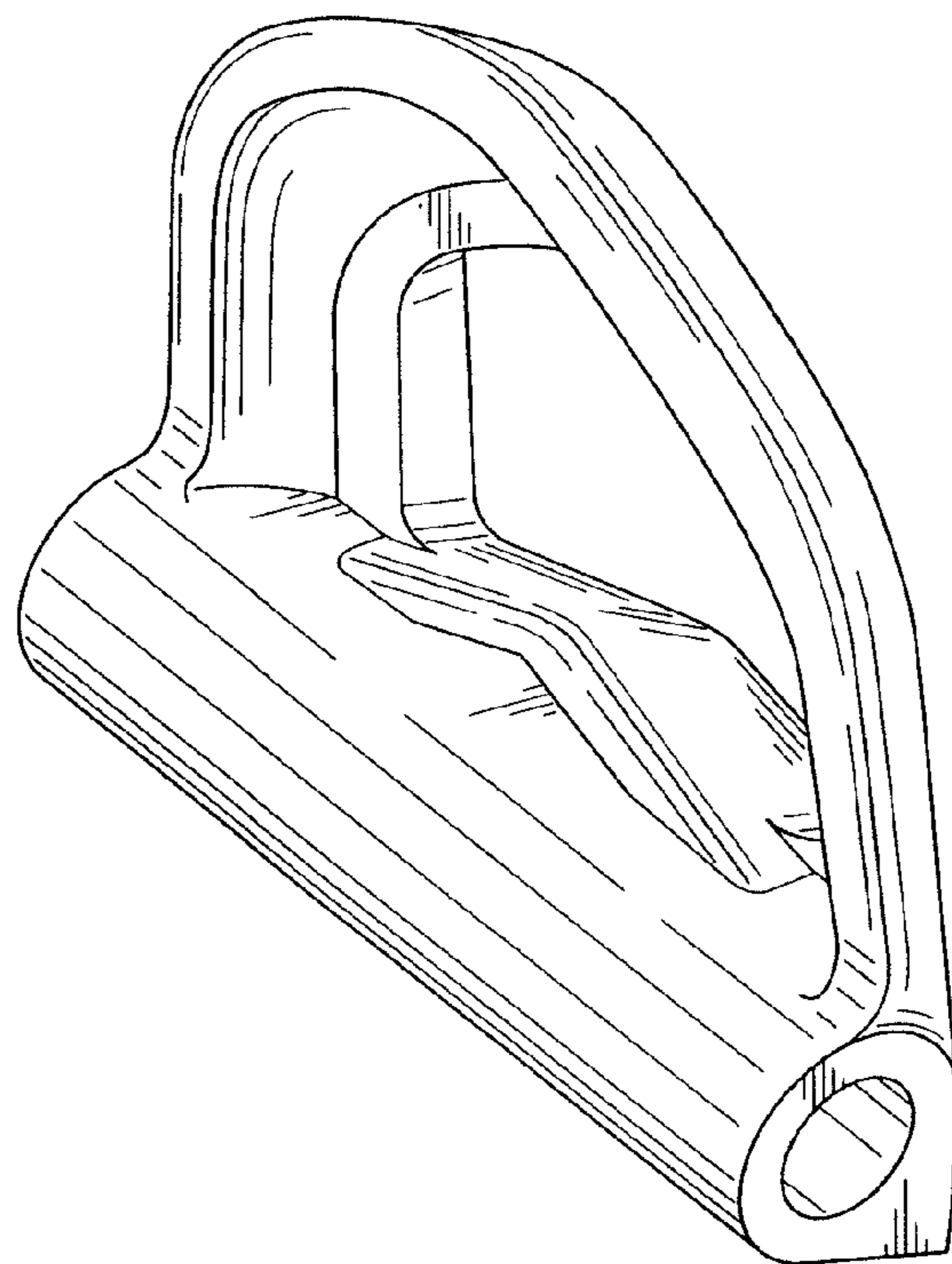
The portions shown in broken lines are for illustrative purposes only and form no part of the claimed design.

**1 Claim, 4 Drawing Sheets**

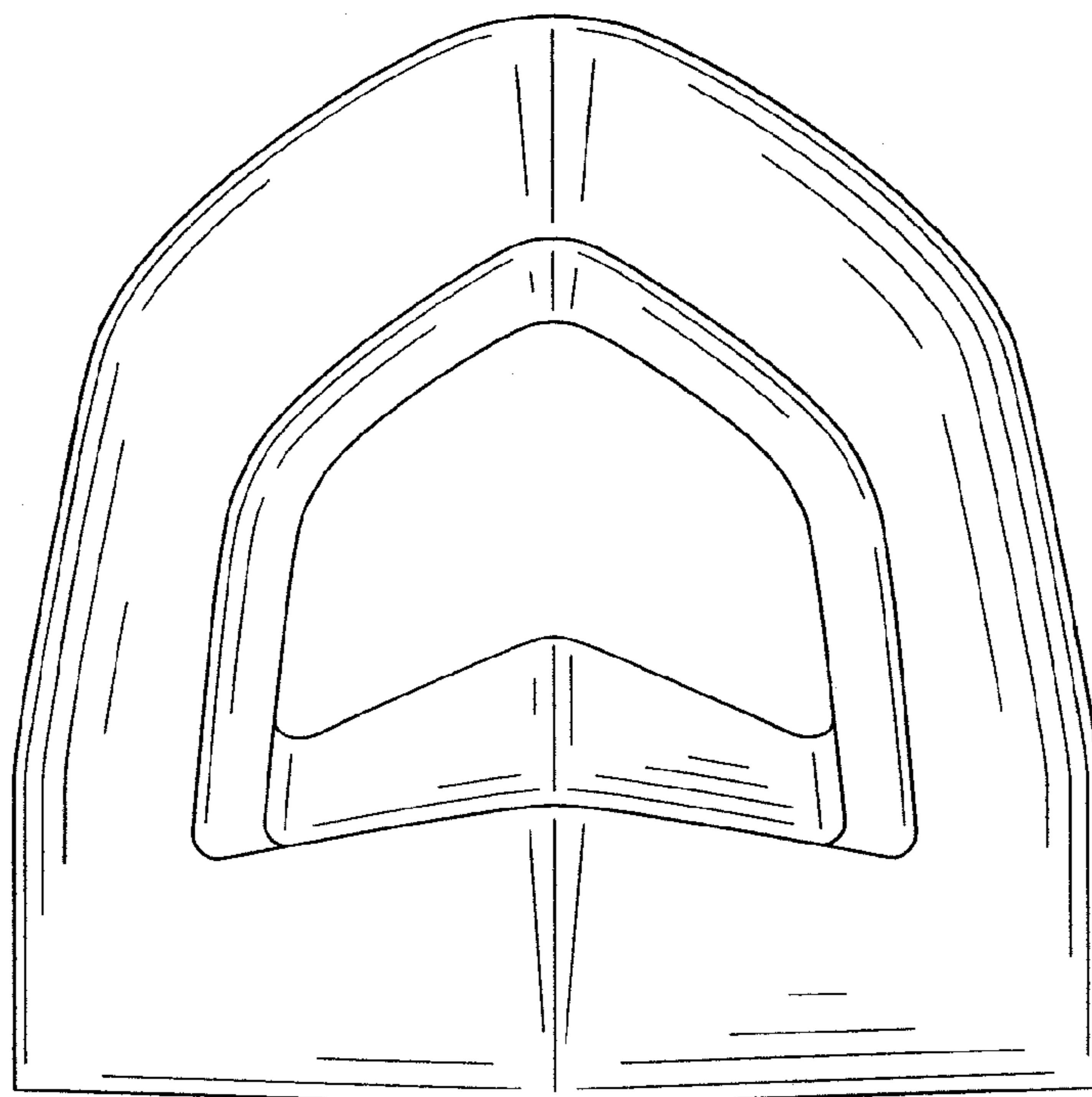




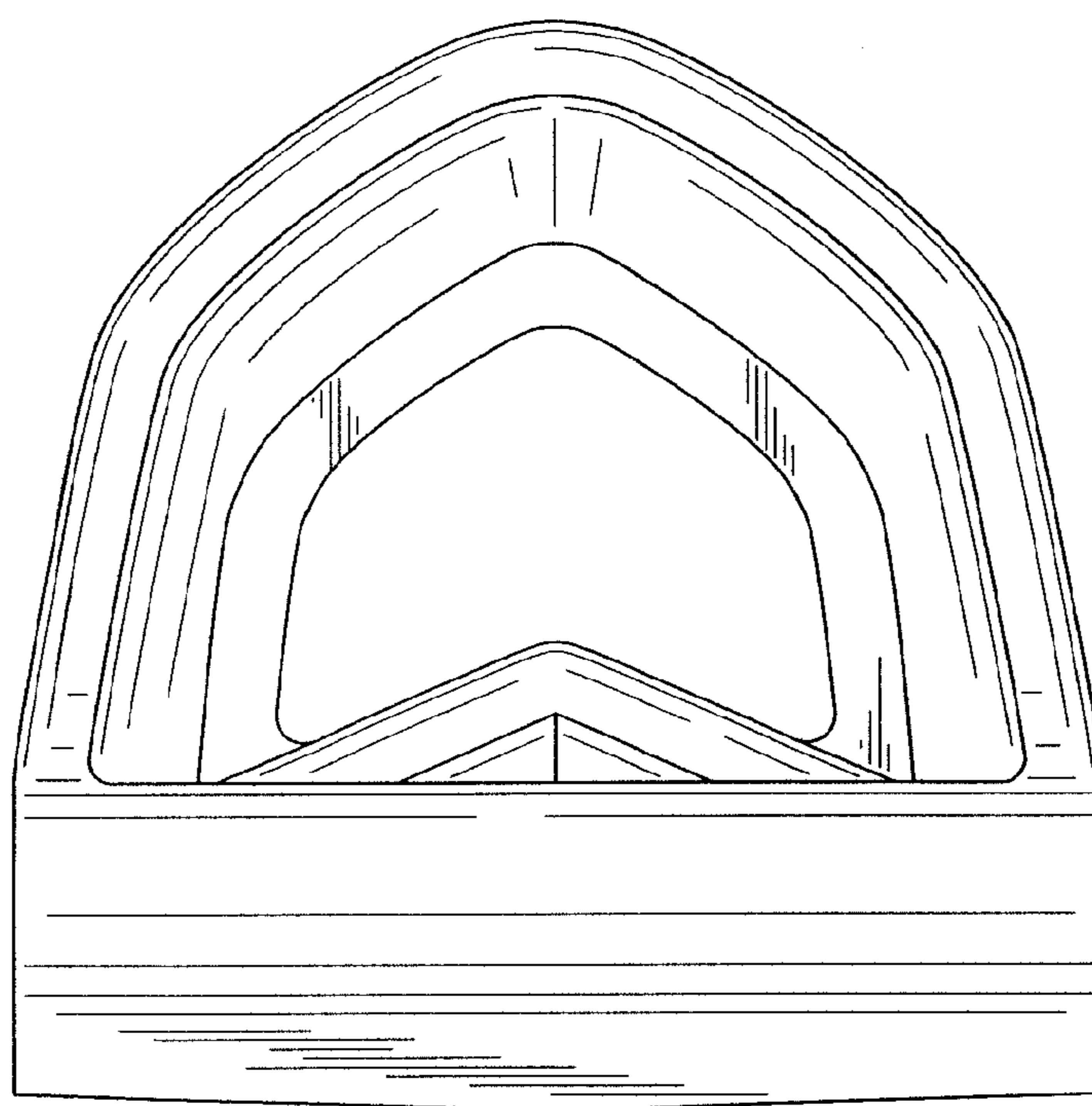
*FIG. 1*



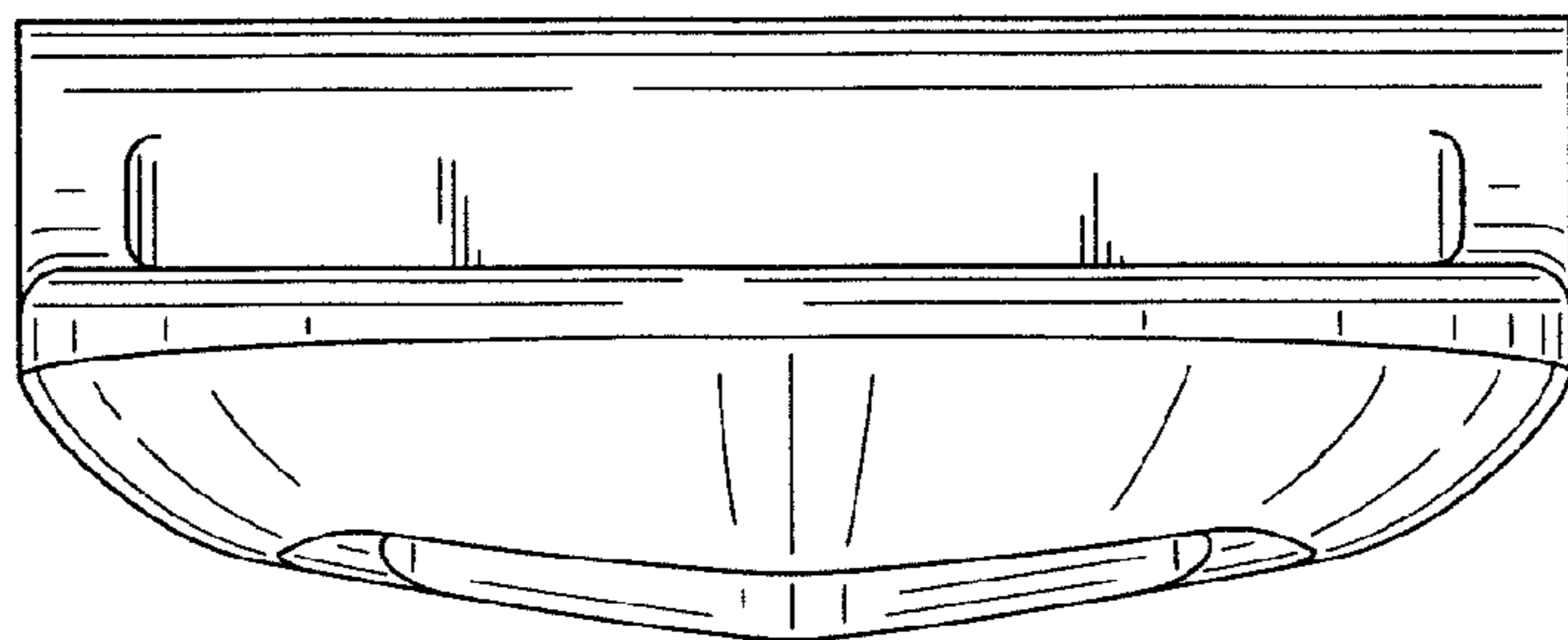
*FIG. 2*



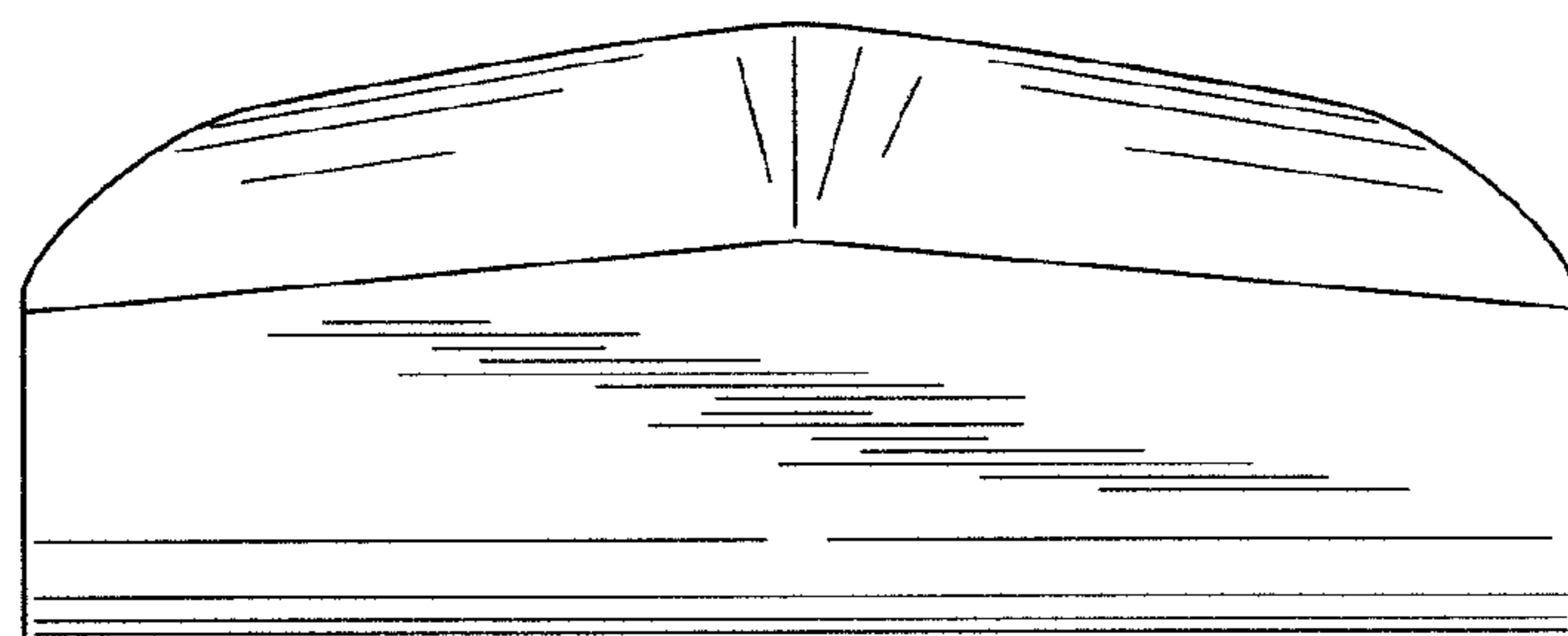
*FIG. 3*



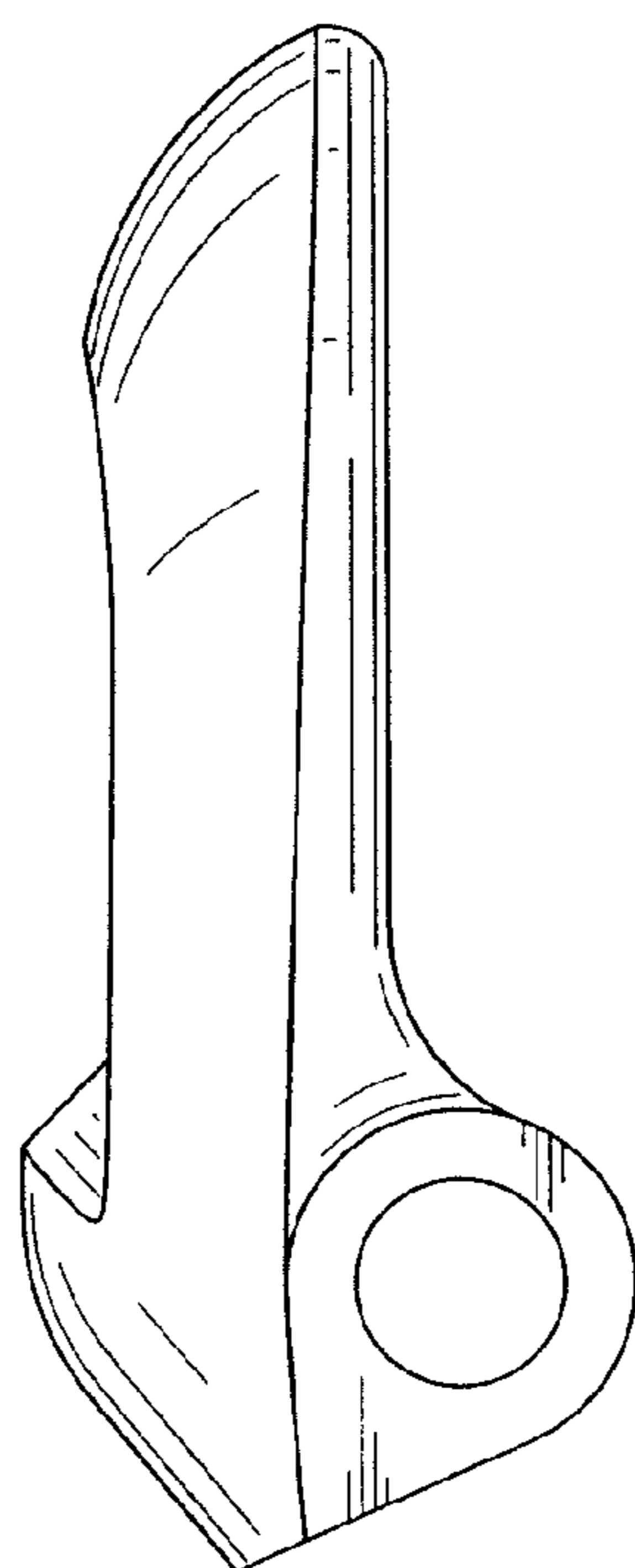
*FIG. 4*



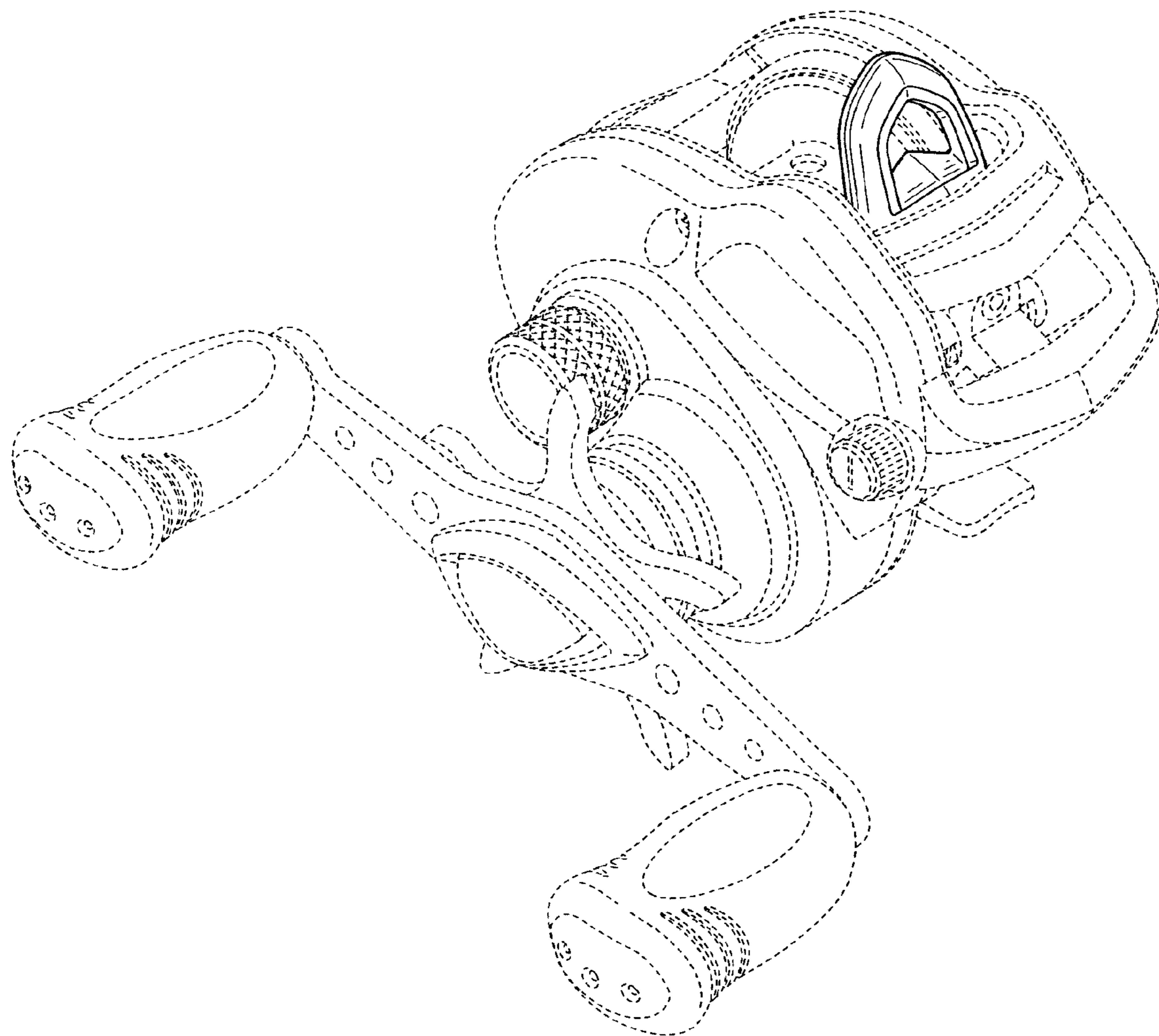
*FIG. 5*



*FIG. 6*



*FIG. 7*



**FIG. 8**