



US00D573575S

(12) **United States Design Patent**  
**Song et al.**

(10) **Patent No.:** **US D573,575 S**

(45) **Date of Patent:** **\*\* Jul. 22, 2008**

(54) **MOBILE PHONE**

(75) Inventors: **Han-Gil Song**, Seoul (KR);  
**Yoon-Young Cho**, Seoul (KR);  
**Chang-Soo Lee**, Incheon (KR)

(73) Assignee: **Samsung Electronics Co., Ltd.**,  
Suwon-Si (KR)

(\*\*) Term: **14 Years**

(21) Appl. No.: **29/293,584**

(22) Filed: **Nov. 30, 2007**

(30) **Foreign Application Priority Data**

Aug. 1, 2007 (KR) ..... 30-2007-0033184

(51) **LOC (8) Cl.** ..... **14-03**

(52) **U.S. Cl.** ..... **D14/138**

(58) **Field of Classification Search** ..... D14/138,  
D14/496, 341-347; 455/575.3, 575.1; D21/517  
See application file for complete search history.

(56) **References Cited**

**U.S. PATENT DOCUMENTS**

D292,706 S *	11/1987	Fischer	.....	D14/345
D488,454 S *	4/2004	Lee	.....	D14/138
6,748,242 B1 *	6/2004	Dunleavy	.....	455/566
D500,994 S *	1/2005	Lee et al.	.....	D14/138
D519,966 S *	5/2006	Salmi et al.	.....	D14/138
D521,971 S *	5/2006	Kim et al.	.....	D14/138
D536,689 S *	2/2007	Suzuki et al.	.....	D14/138
D537,803 S *	3/2007	Lee et al.	.....	D14/138
D543,172 S *	5/2007	Lee et al.	.....	D14/138
D545,286 S *	6/2007	Lee et al.	.....	D14/138
7,269,443 B2 *	9/2007	Park et al.	.....	455/556.2
D558,712 S *	1/2008	Kim et al.	.....	D14/138
D559,814 S *	1/2008	Kim et al.	.....	D14/138
D559,825 S *	1/2008	Park et al.	.....	D14/138
D560,186 S *	1/2008	Kim et al.	.....	D14/138
D560,187 S *	1/2008	Kim et al.	.....	D14/138
D560,189 S *	1/2008	Kim et al.	.....	D14/138
D560,637 S *	1/2008	Yang et al.	.....	D14/138
D560,639 S *	1/2008	Kim et al.	.....	D14/138

D560,640 S *	1/2008	Suk et al.	.....	D14/138
D561,151 S *	2/2008	Kim et al.	.....	D14/138
D561,728 S *	2/2008	Kim et al.	.....	D14/138
D563,351 S *	3/2008	Baik et al.	.....	D14/138
D563,367 S *	3/2008	Chung et al.	.....	D14/138
2001/0011029 A1 *	8/2001	Iwabuchi et al.	.....	455/566
2005/0176481 A1 *	8/2005	Jeong	.....	455/575.7

**OTHER PUBLICATIONS**

Samsung E210 telephone, announced Aug. 2007, [online], [site visited Mar. 28, 2008]. Available from Internet ,<URL: <http://www.gsmarena.com>>.\*

Samsung X410 telephone, announced 2<sup>nd</sup> quarter 2003, [online], [site visited Mar. 28, 2008]. Available from Internet ,<URL: <http://www.gsmarena.com>>.\*

Samsung E870 telephone, announced 1st quarter 2006, [online], [site visited Mar. 28, 2008]. Available from Internet ,<URL: <http://www.gsmarena.com>>.\*

(Continued)

*Primary Examiner*—Jeffrey D Asch  
(74) *Attorney, Agent, or Firm*—Staas & Halsey LLP

(57) **CLAIM**

The ornamental design for a mobile phone, as shown and described.

**DESCRIPTION**

FIG. 1 is a perspective view of a mobile phone;  
FIG. 2 is a front view of the mobile phone of FIG. 1;  
FIG. 3 is a rear view of the mobile phone of FIG. 1;  
FIG. 4 is a left-side view of the mobile phone of FIG. 1;  
FIG. 5 is a right-side view of the mobile phone of FIG. 1;  
FIG. 6 is a top plan view of the mobile phone of FIG. 1;  
FIG. 7 is a bottom plan view of the mobile phone of FIG. 1;  
and,  
FIG. 8 is an open perspective view of the mobile phone.

**1 Claim, 6 Drawing Sheets**

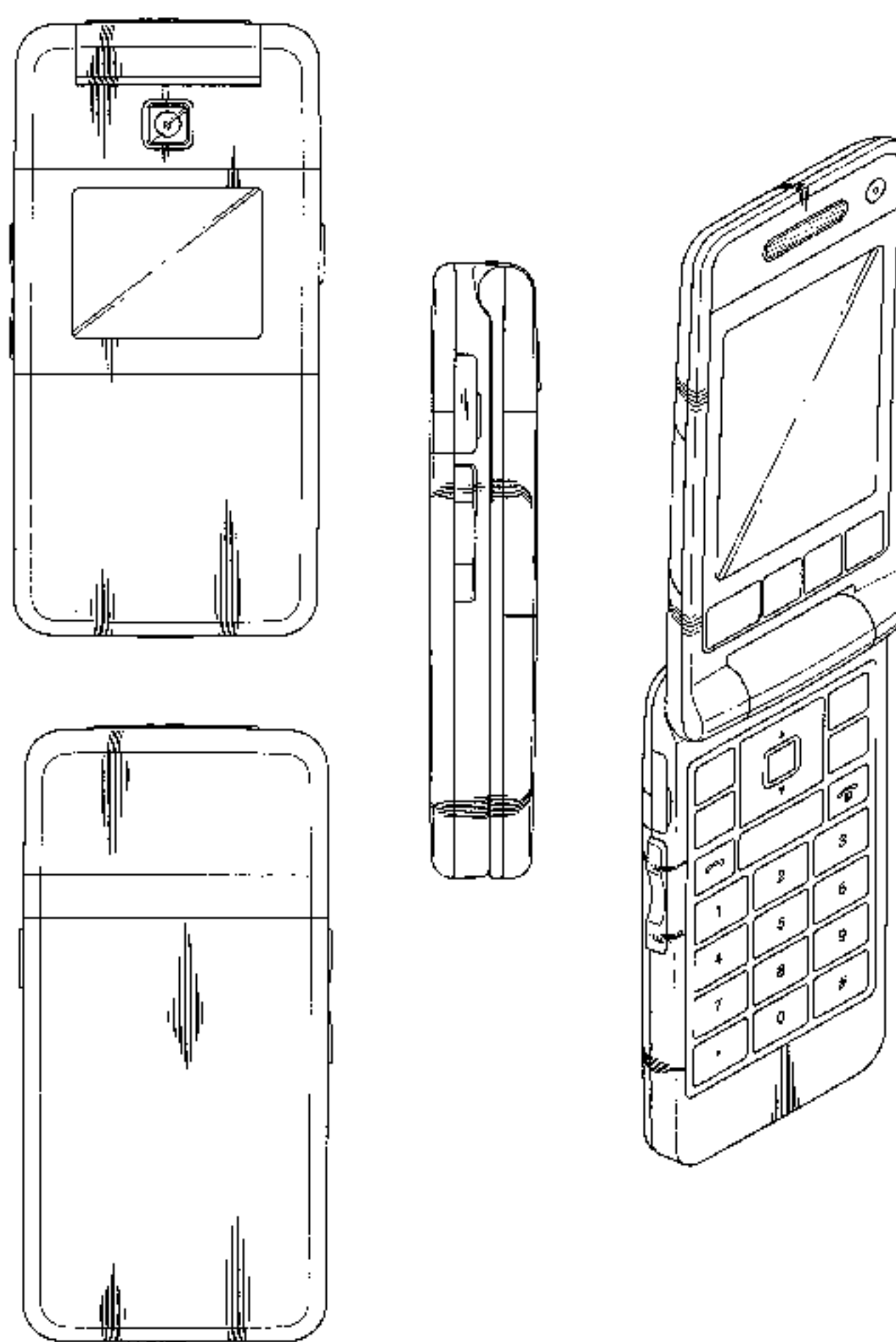

OTHER PUBLICATIONS

LG KU730 telephone, announced Feb. 2006, [online], [site visited Mar. 28, 2008]. Available from Internet ,<URL: <http://www.gsmarena.com>>.\*

Sagem my401C telephone, announced Mar. 2007, [online], [site visited Mar. 28, 2008]. Available from Internet ,<URL: <http://www.gsmarena.com>>.\*

Sharp GX33 telephone, announced 3<sup>rd</sup> quarter 2007, [online], [site visited Mar. 28, 2008]. Available from Internet ,<URL: <http://www.gsmarena.com>>.\*

BenQ-Siemens EF71 telephone, announced May 2006, [online], [site visited Mar. 28, 2008]. Available from Internet ,<URL: <http://www.gsmarena.com>>.\*

Pantech PG-2800 telephone, announced May 2006, [online], [site visited Mar. 28, 2008]. Available from Internet ,<URL: <http://www.gsmarena.com>>.\*

\* cited by examiner

FIG. 1

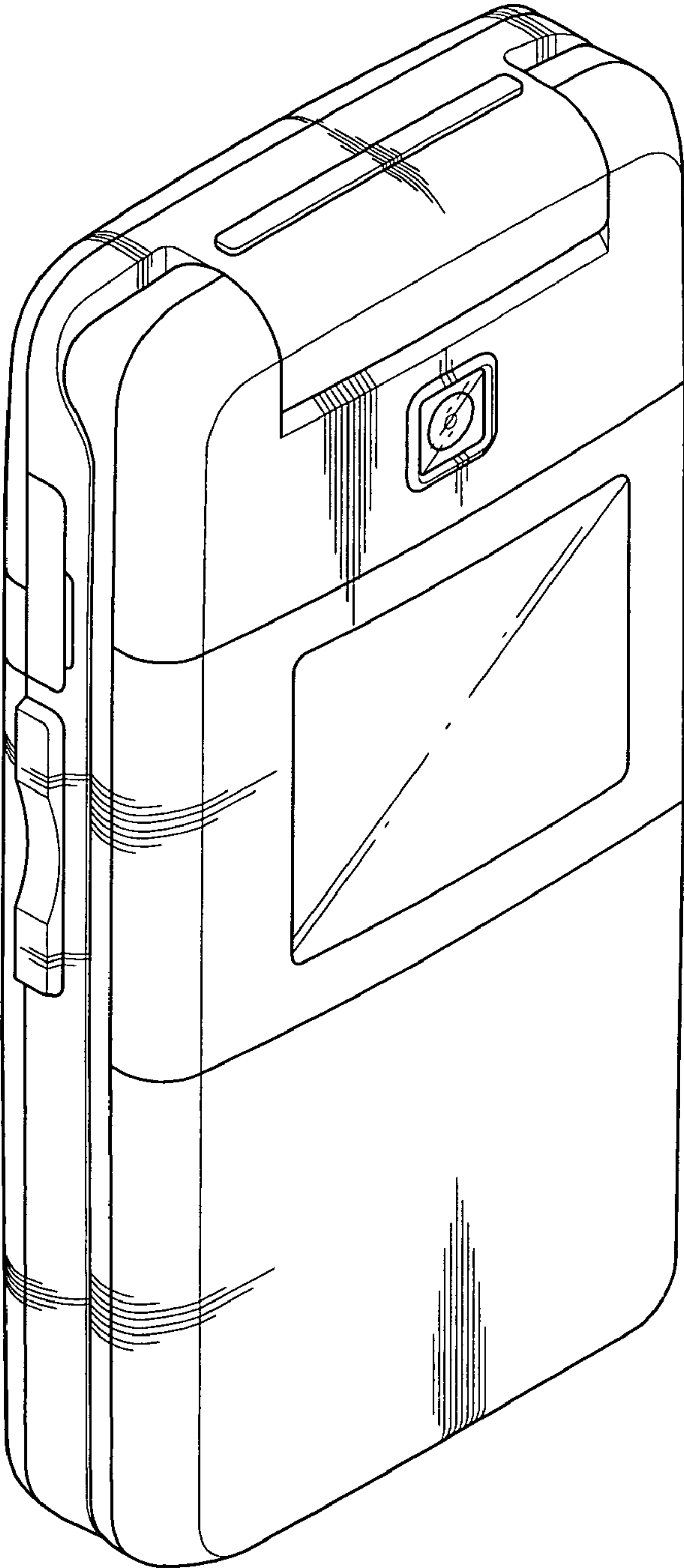

FIG. 2

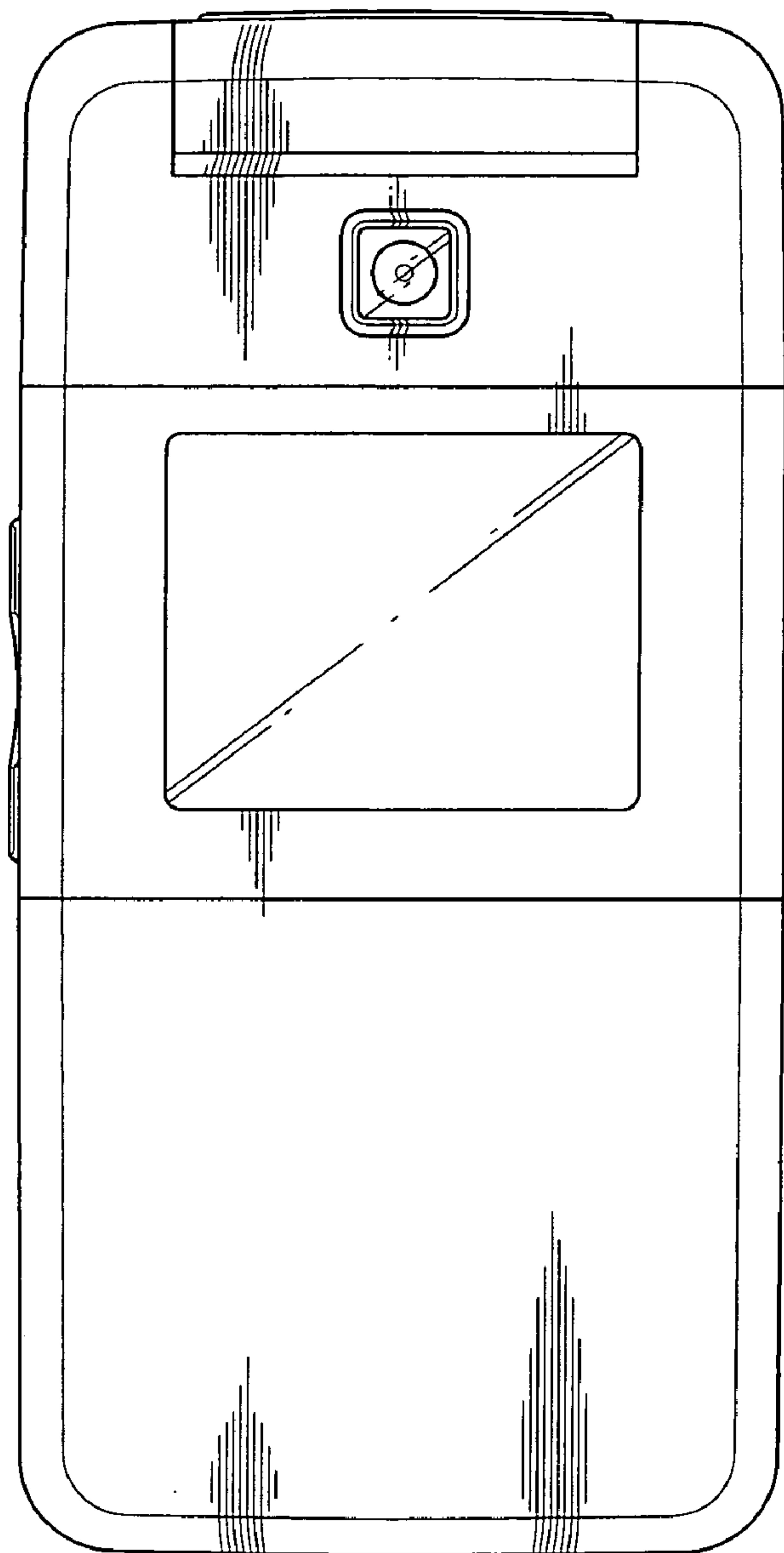

FIG. 3

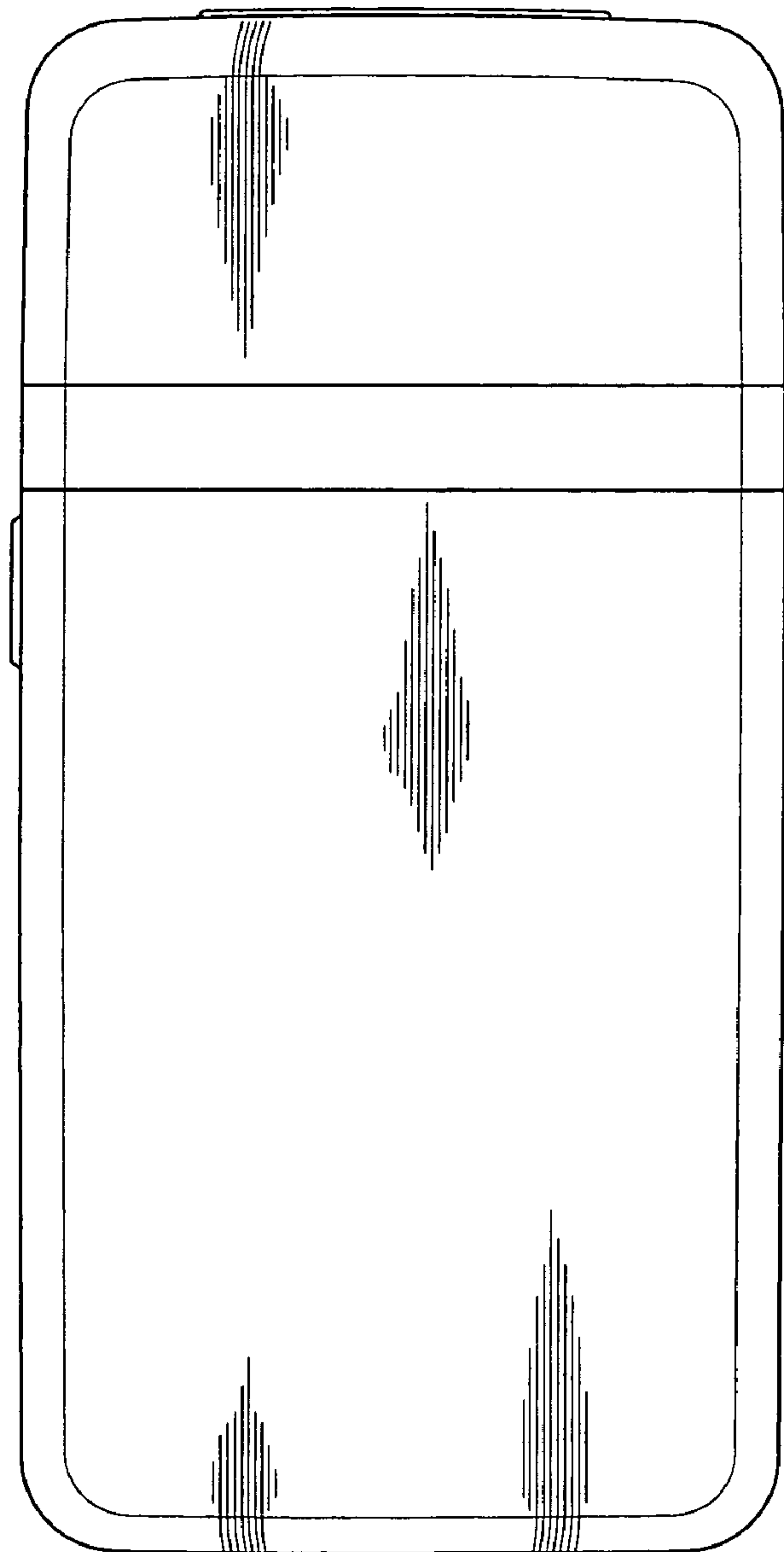

FIG. 4

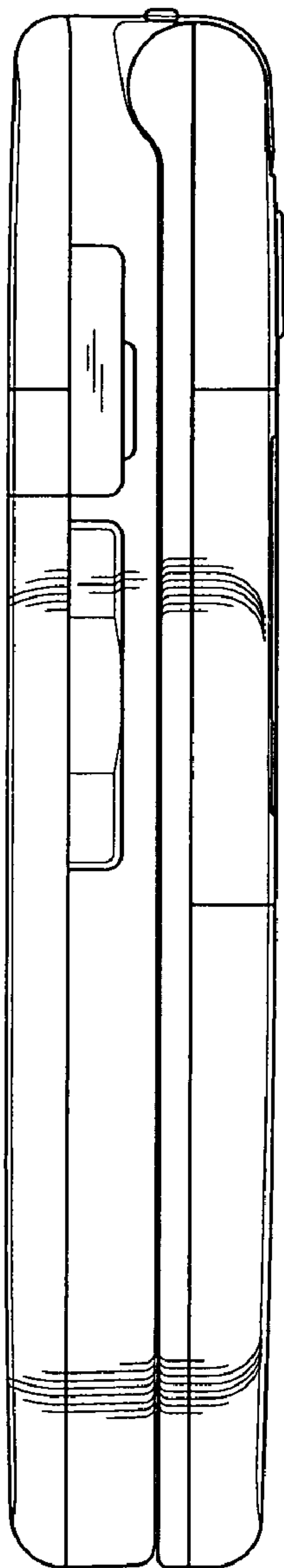

FIG. 5

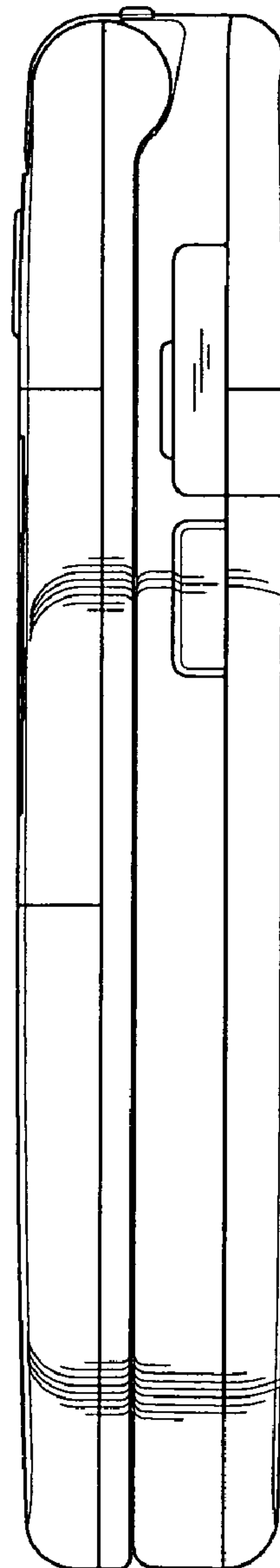

FIG. 6

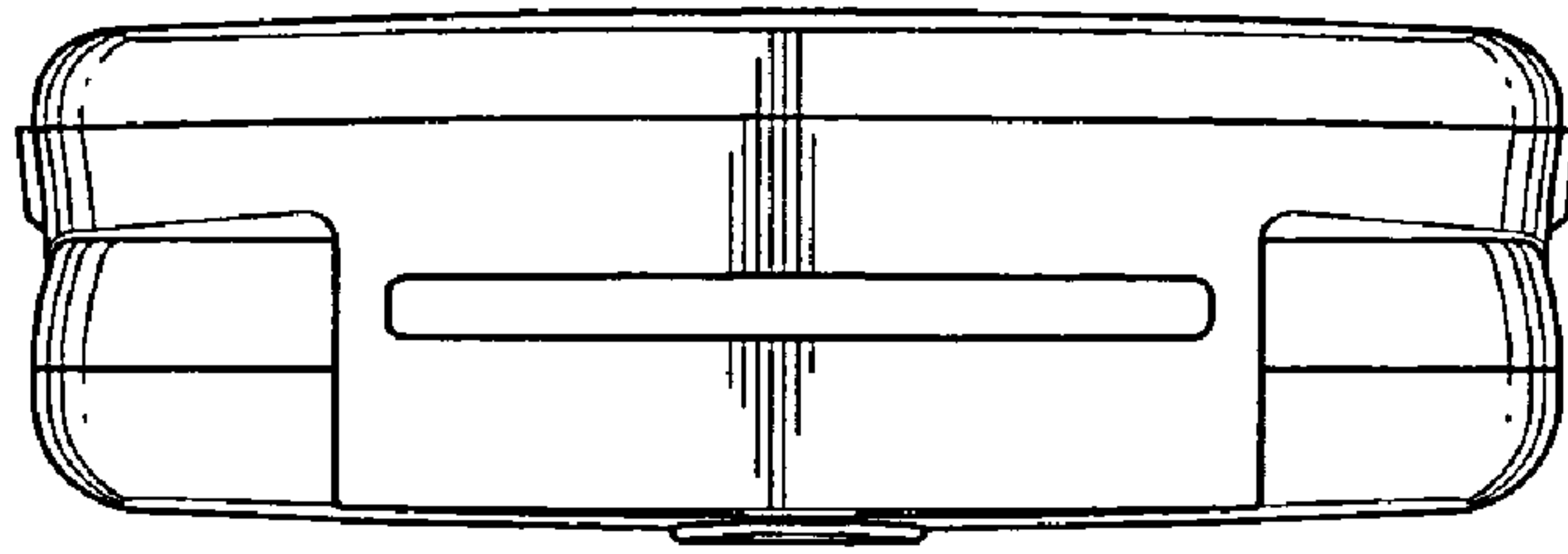

FIG. 7

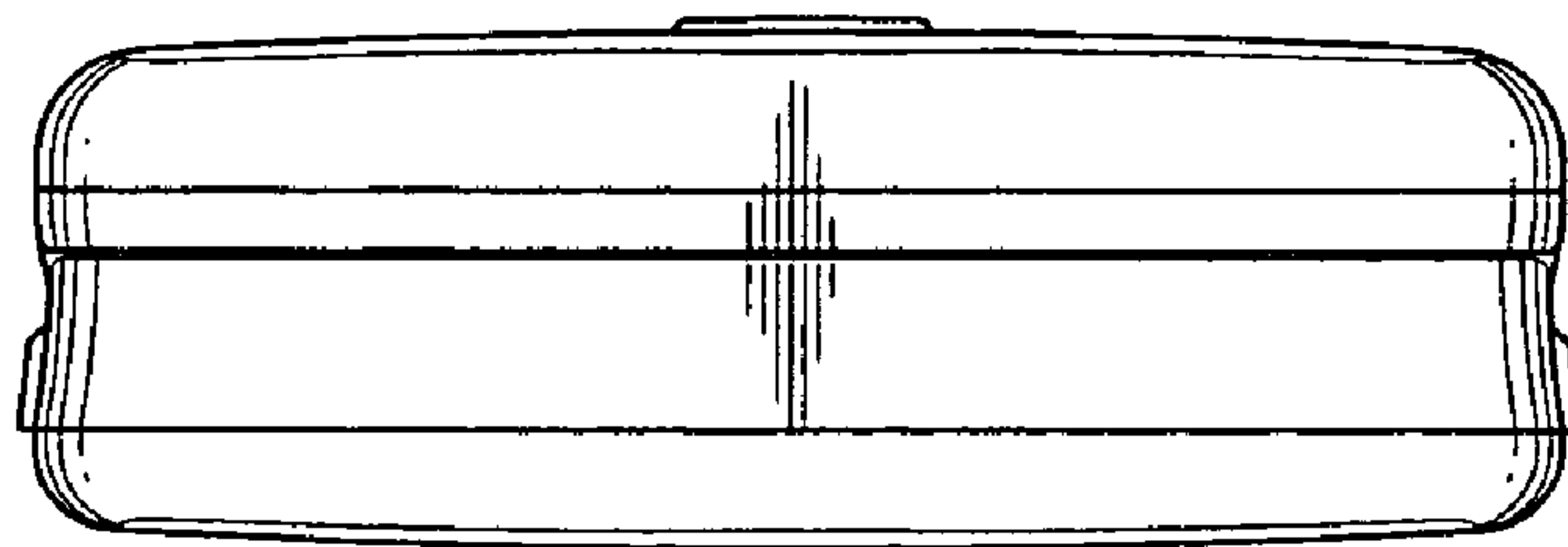



FIG. 8

