



US00D573503S

(12) **United States Design Patent**
Jaso

(10) **Patent No.:** **US D573,503 S**
(45) **Date of Patent:** **** Jul. 22, 2008**

(54) **BASEBALL ARM BAND**

(76) Inventor: **Jaime Doniel Jaso**, P.O. Box 164,
Goliad, TX (US) 77963

(**) Term: **14 Years**

(21) Appl. No.: **29/247,527**

(22) Filed: **Jun. 23, 2006**

(51) **LOC (8) Cl.** **11-01**

(52) **U.S. Cl.** **D11/3**

(58) **Field of Classification Search** D11/1-25,
D11/32, 93, 94; 59/78, 79.2; 63/1.11, 3,
63/3.1, 3.2, 5.1, 5.2, 7-11; 224/175

See application file for complete search history.

(56) **References Cited**

U.S. PATENT DOCUMENTS

D487,708 S * 3/2004 Strle D11/3
D524,377 S * 7/2006 Moskovitz D19/97

* cited by examiner

Primary Examiner—Cathron Brooks

Assistant Examiner—Michael A. Pratt

(74) *Attorney, Agent, or Firm*—Locke Lord Bissell & Liddell
LLP

(57) **CLAIM**

The ornamental design for a baseball arm band, as shown and described.

DESCRIPTION

FIG. 1 is a top perspective view of a first embodiment of a baseball arm band with attachment devices shown in dashed lines;

FIG. 2 is a top view of the band;

FIG. 3 is a bottom view of the band;

FIG. 4 is a side view of the band with the opposite side being a mirror image; and

FIG. 5 is an end view of the band with the opposite end being a mirror image.

FIG. 6 is a top perspective view of a Second embodiment of a baseball arm band with attachment devices shown in dashed lines;

FIG. 7 is a top view of the band;

FIG. 8 is a bottom view of the band;

FIG. 9 is a side view of the band with the opposite side being a mirror image; and

FIG. 10 is an end view of the band with the opposite end being a mirror image.

FIG. 11 is a top perspective view of a Third embodiment of a baseball arm band with attachment devices shown in dashed lines;

FIG. 12 is a top view of the band;

FIG. 13 is a bottom view of the band;

FIG. 14 is a side view of the band with the opposite side being a mirror image; and,

FIG. 15 is an end view of the band with the opposite end being a mirror image.

The broken lines shown in FIGS. 1-15 forms no part of the claimed design.

1 Claim, 11 Drawing Sheets

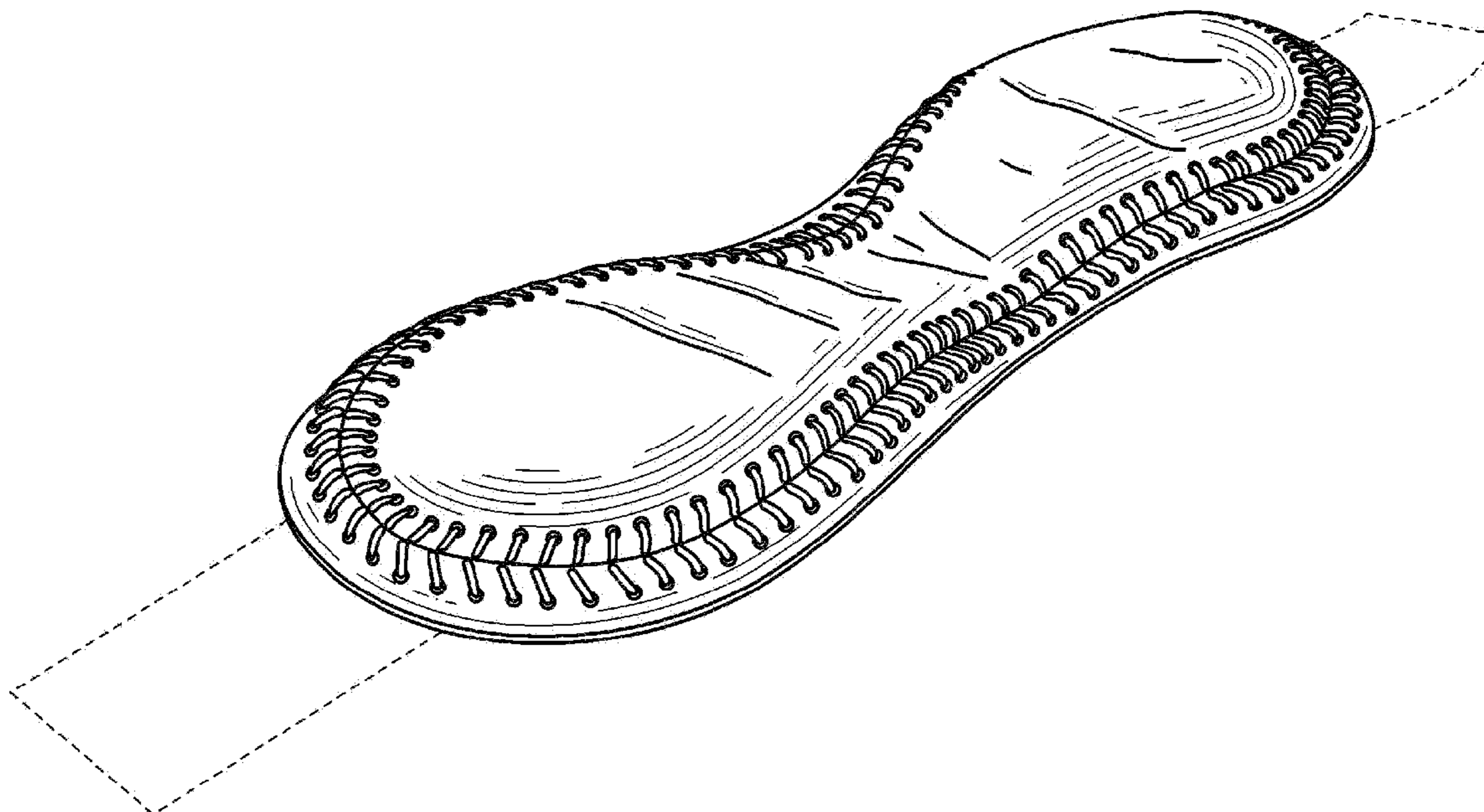

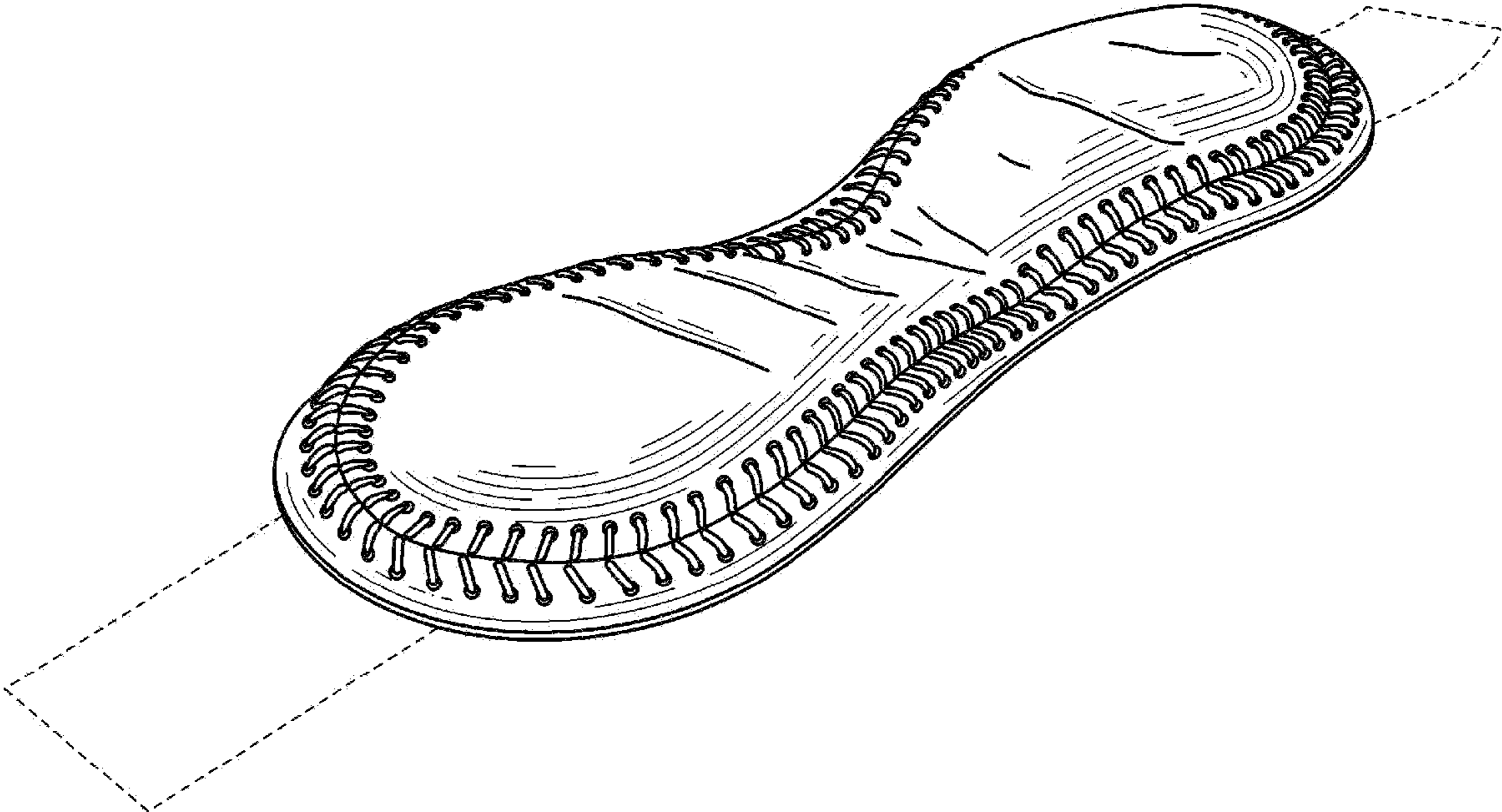

FIG. 1

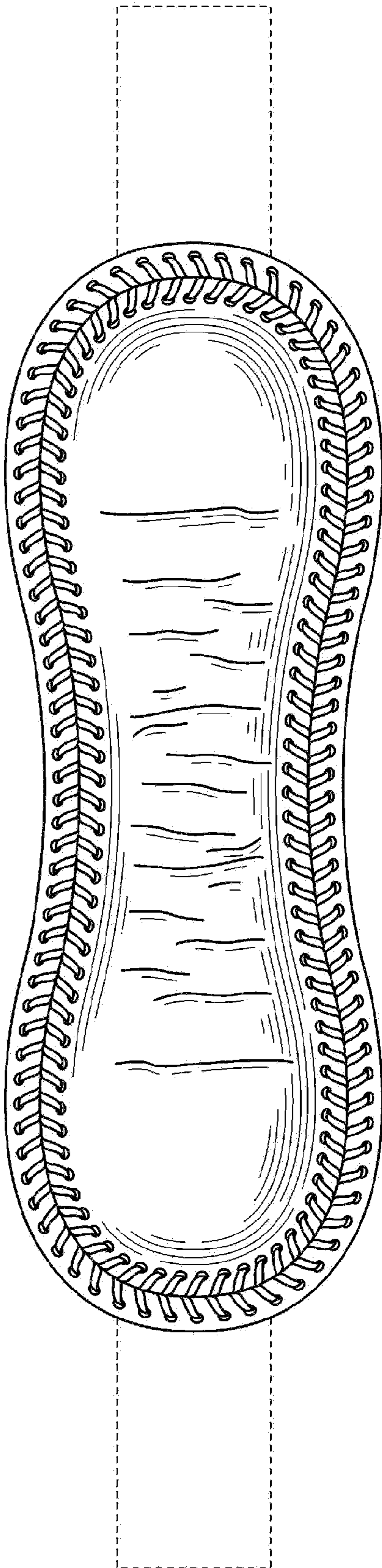

FIG. 2

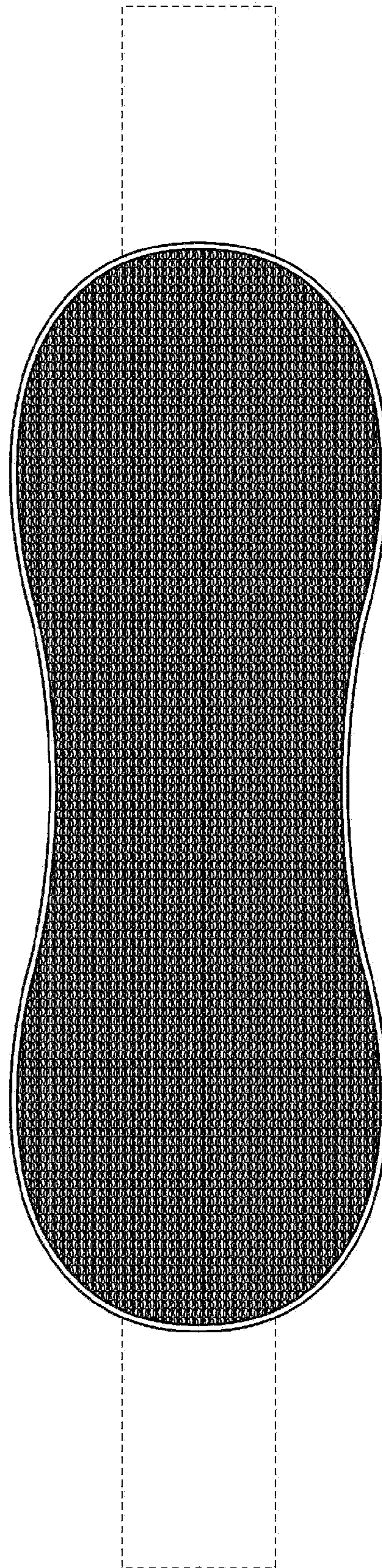

FIG. 3

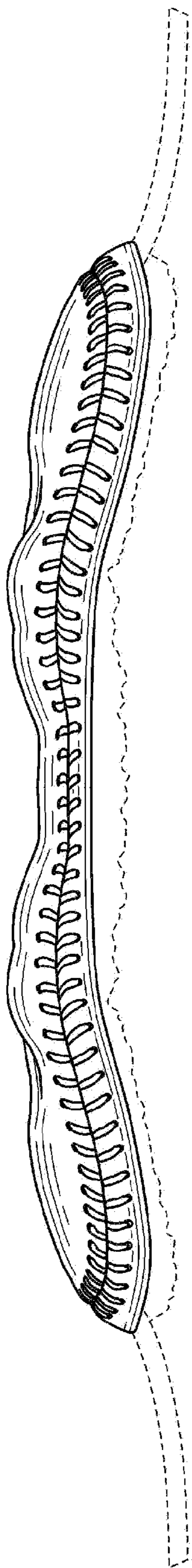

FIG. 4

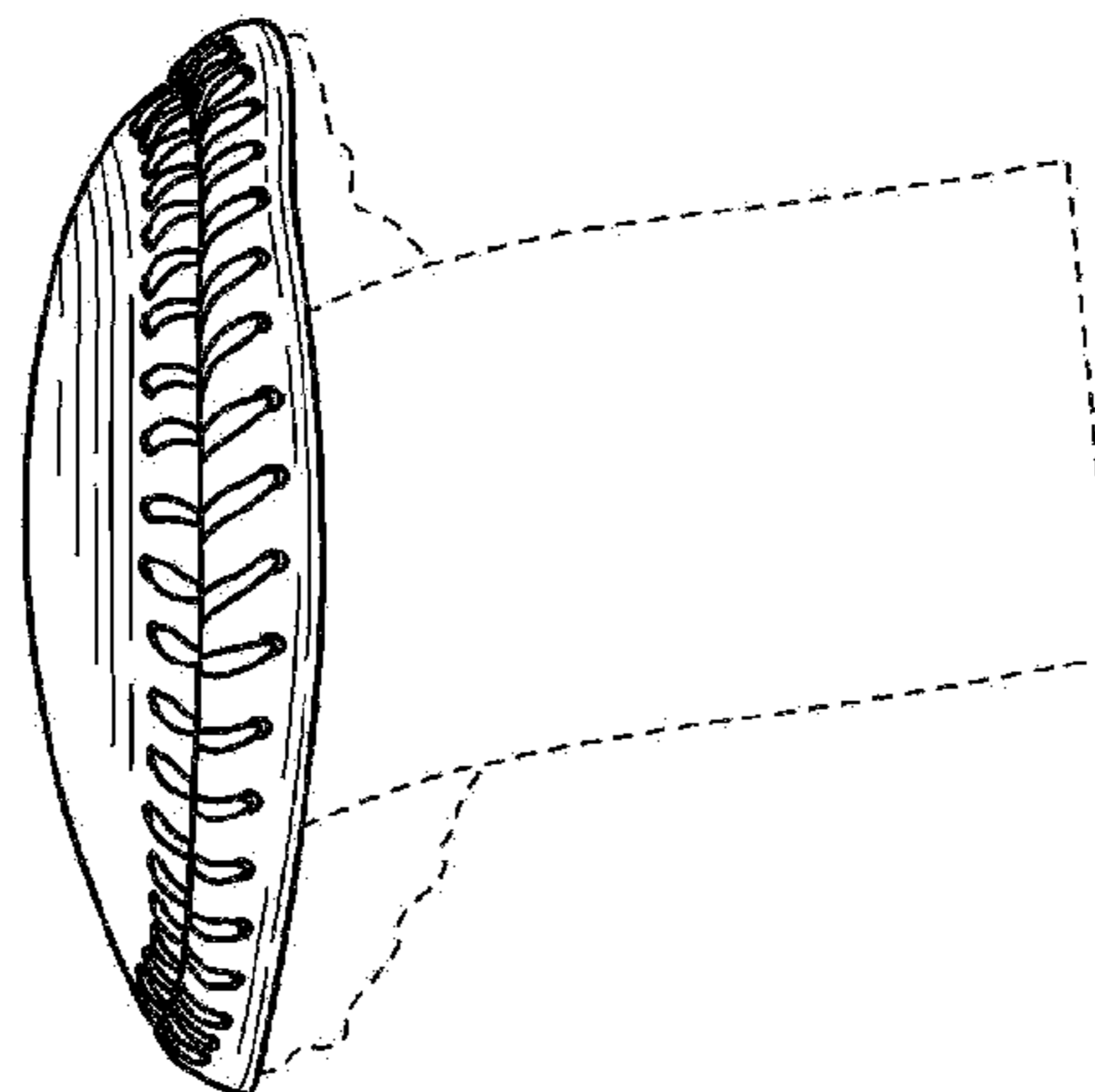

FIG. 5

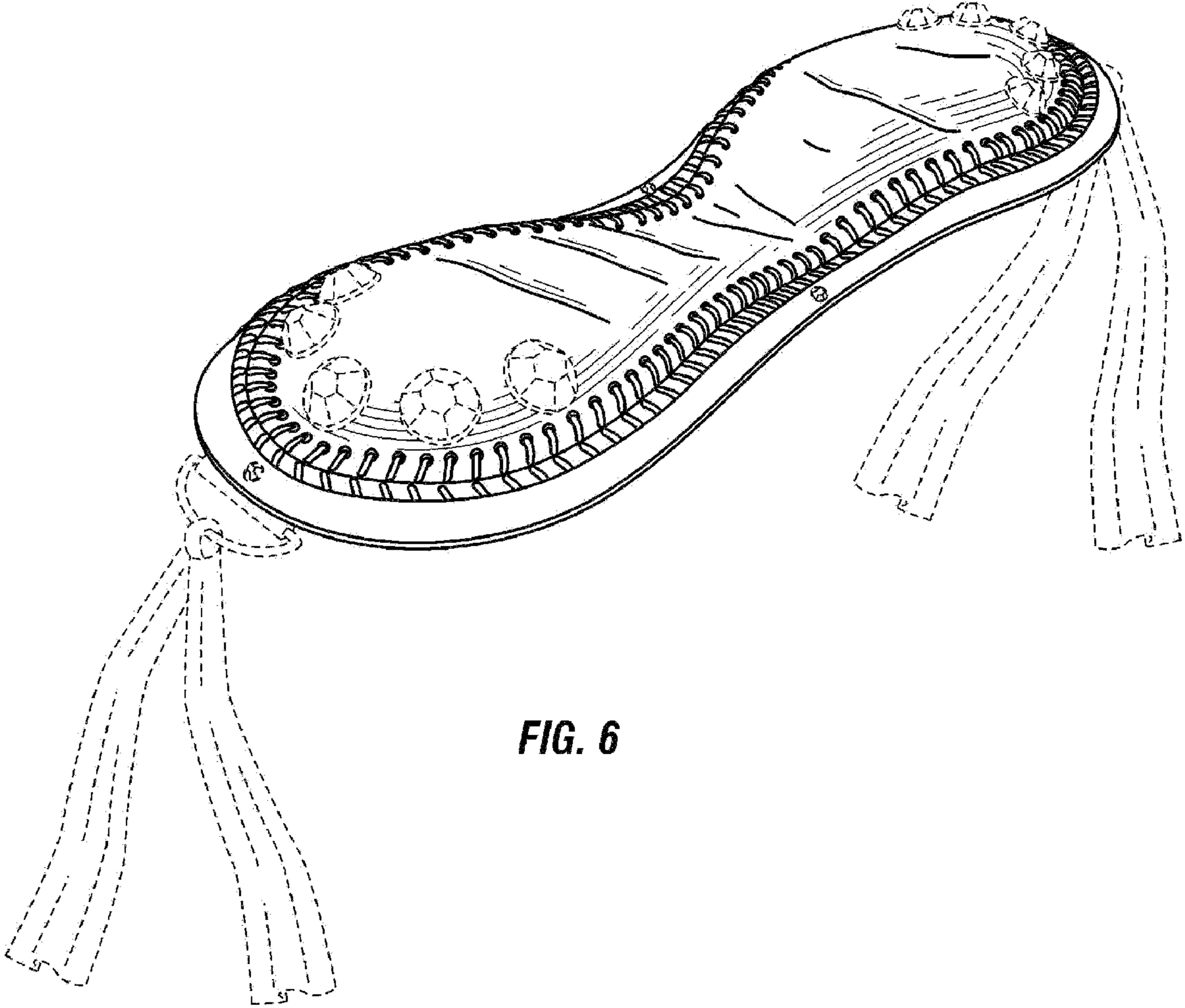

FIG. 6

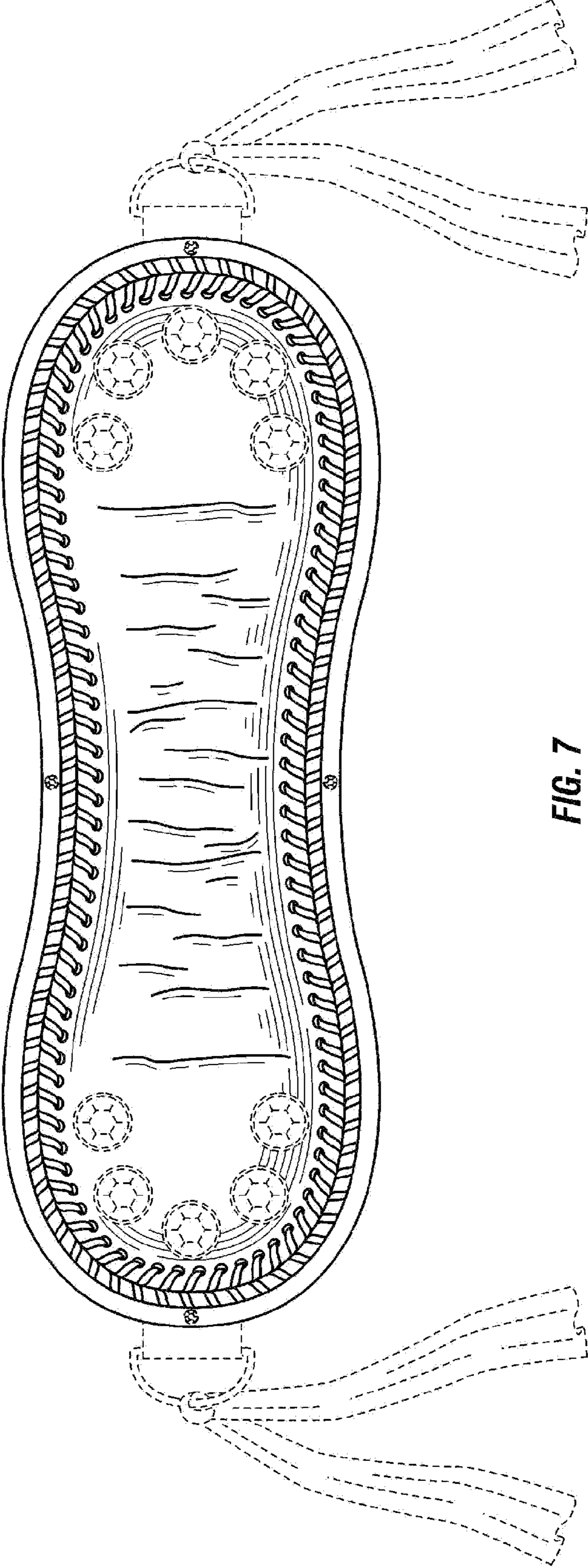

FIG. 7

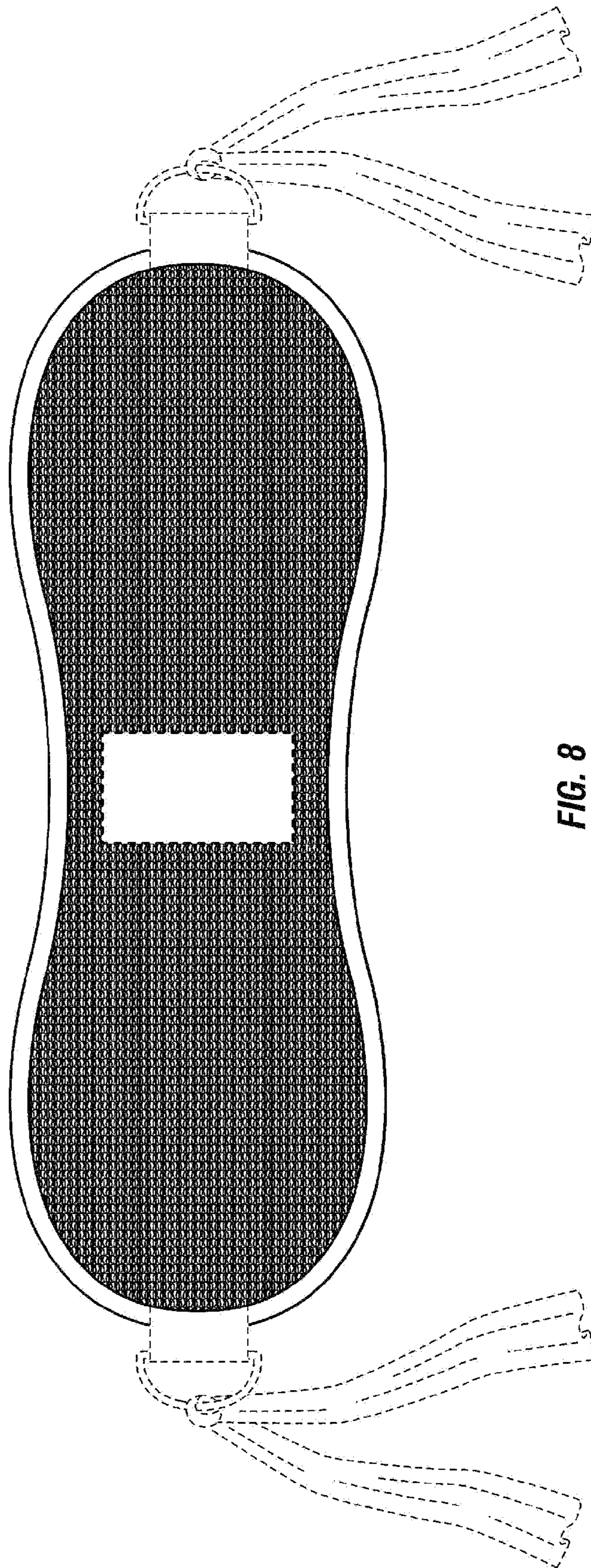

FIG. 8

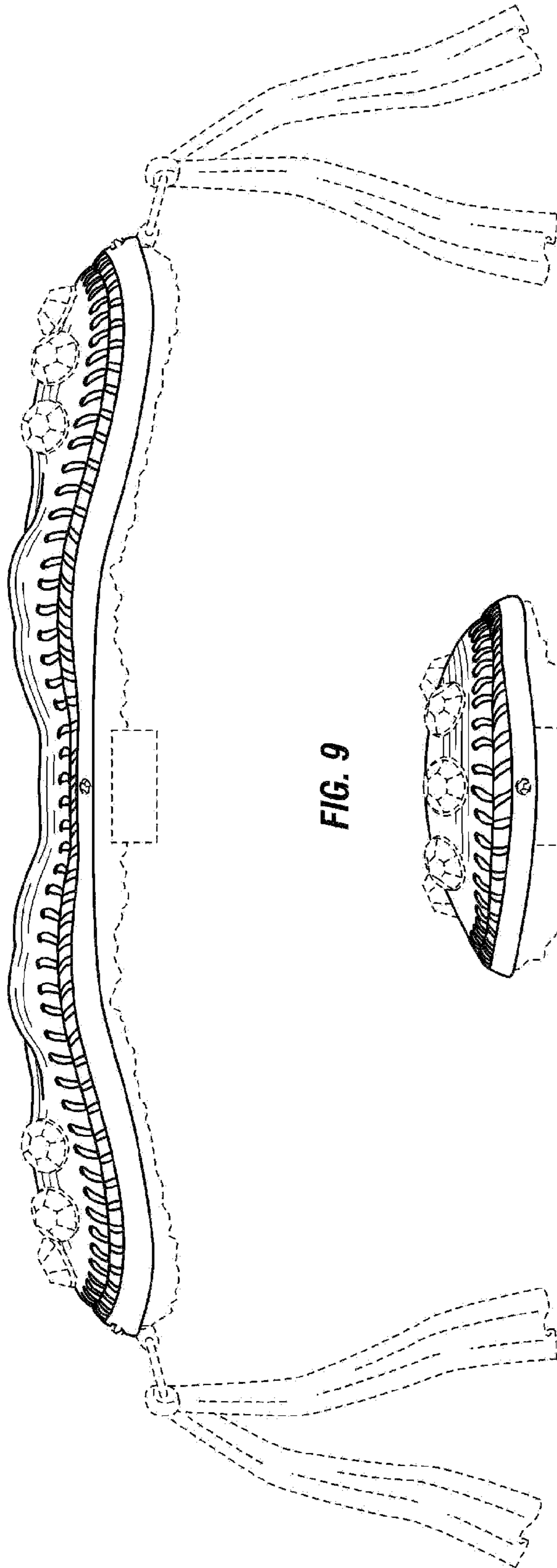

FIG. 9

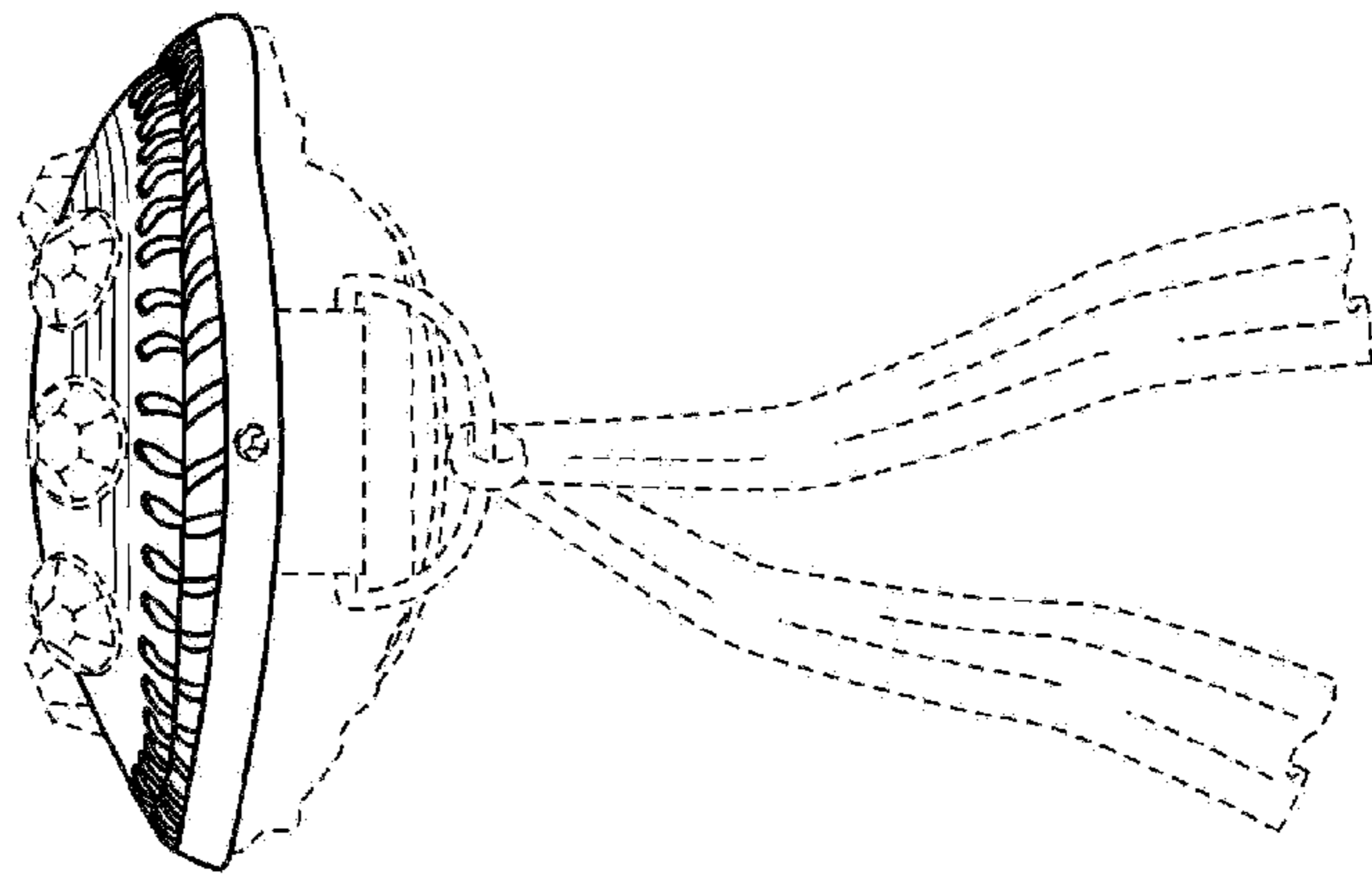

FIG. 10

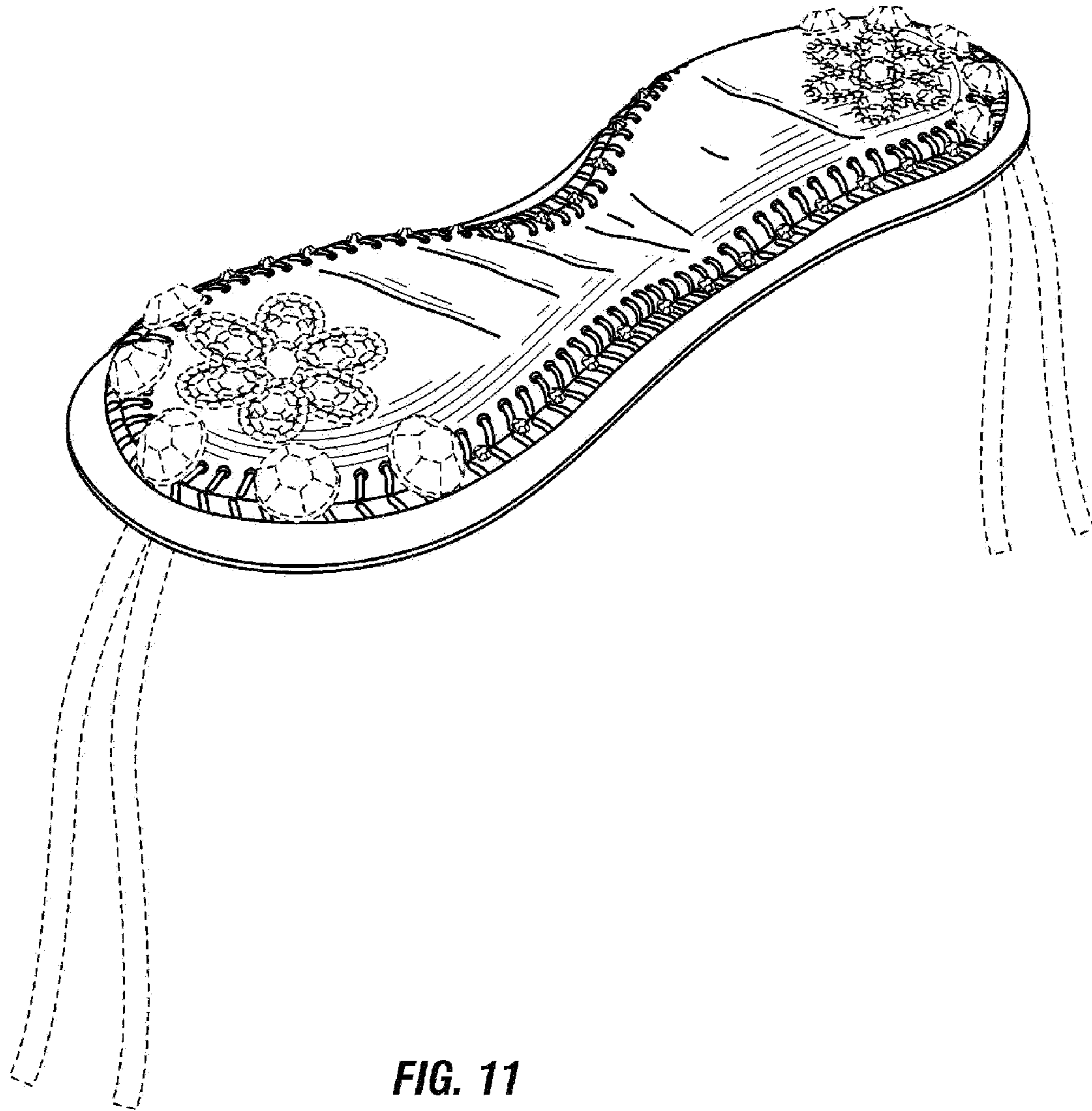

FIG. 11

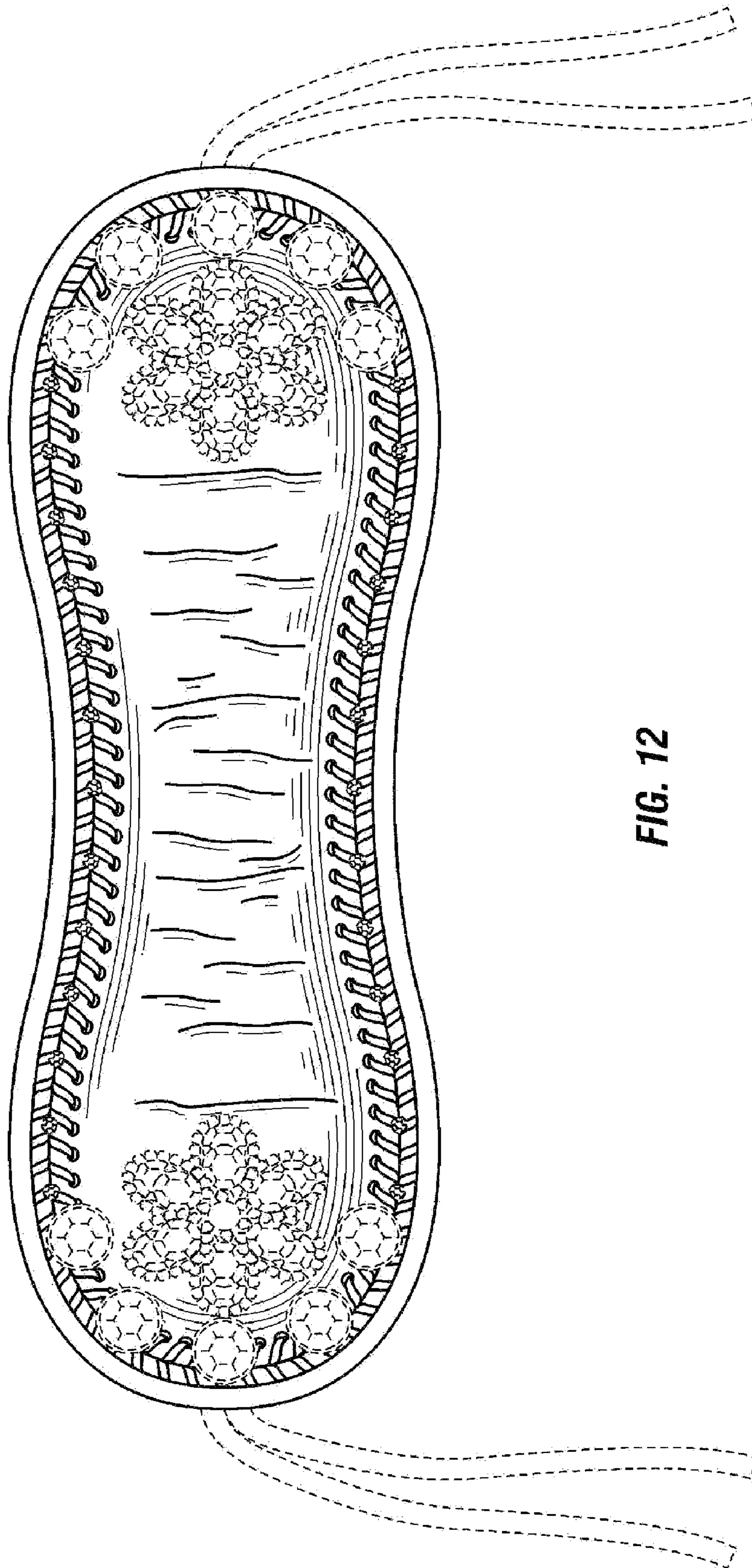

FIG. 12

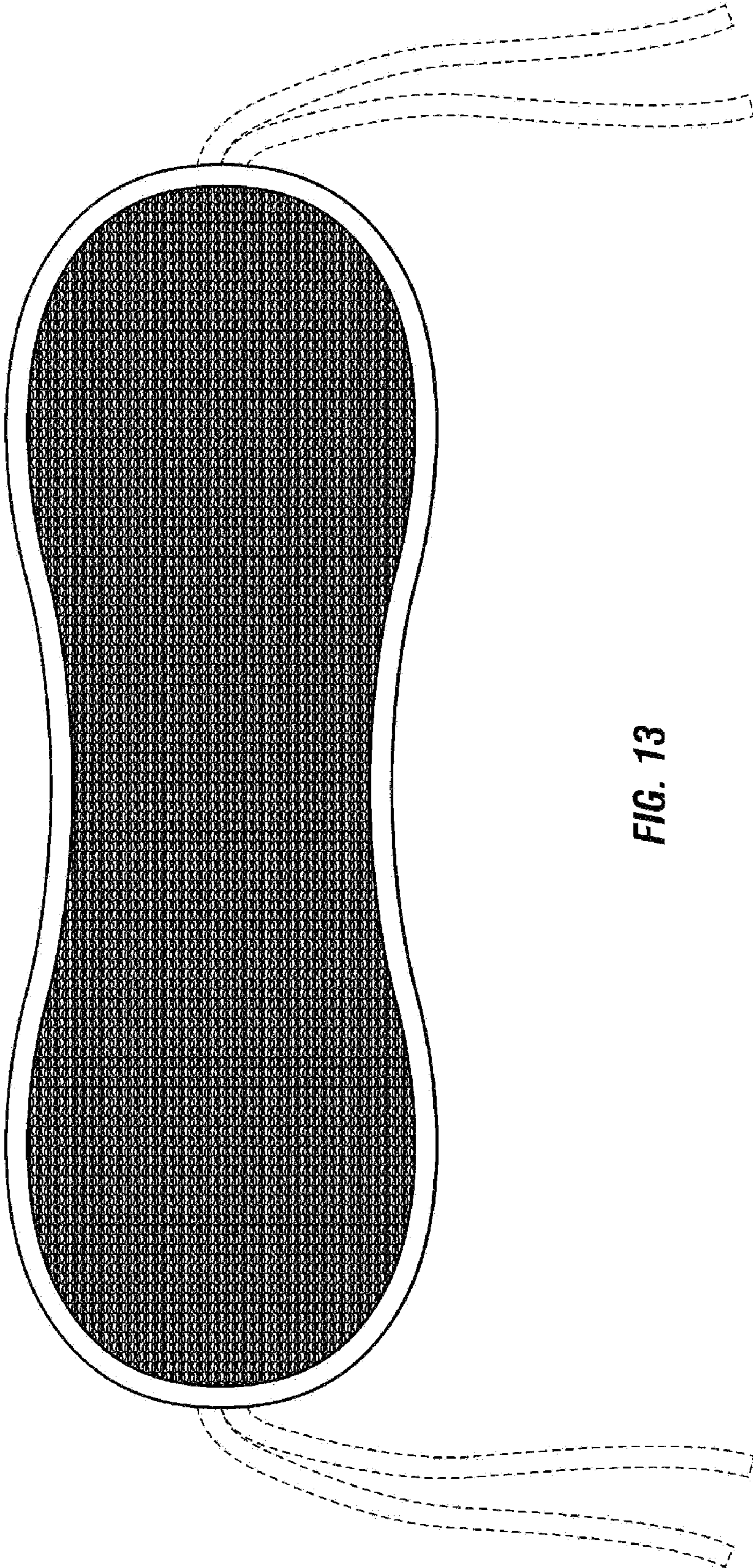

FIG. 13

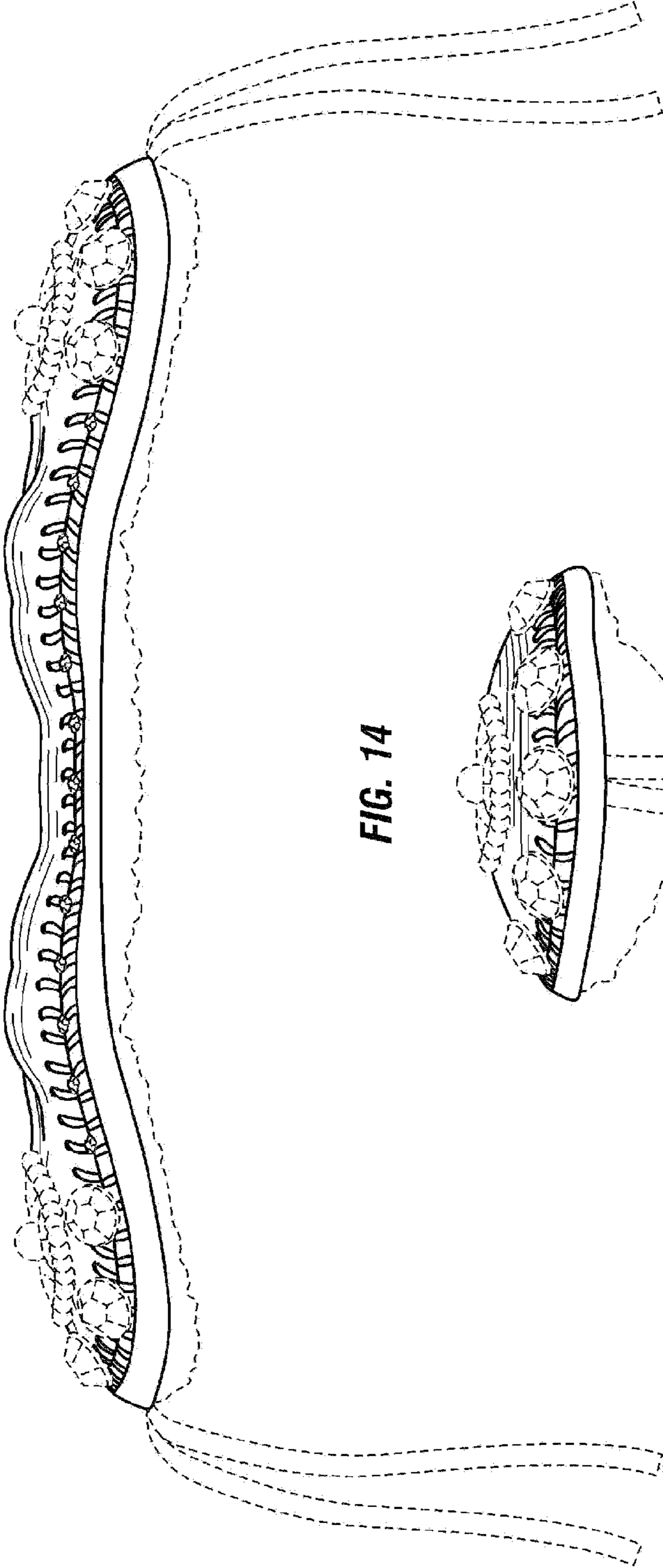

FIG. 14

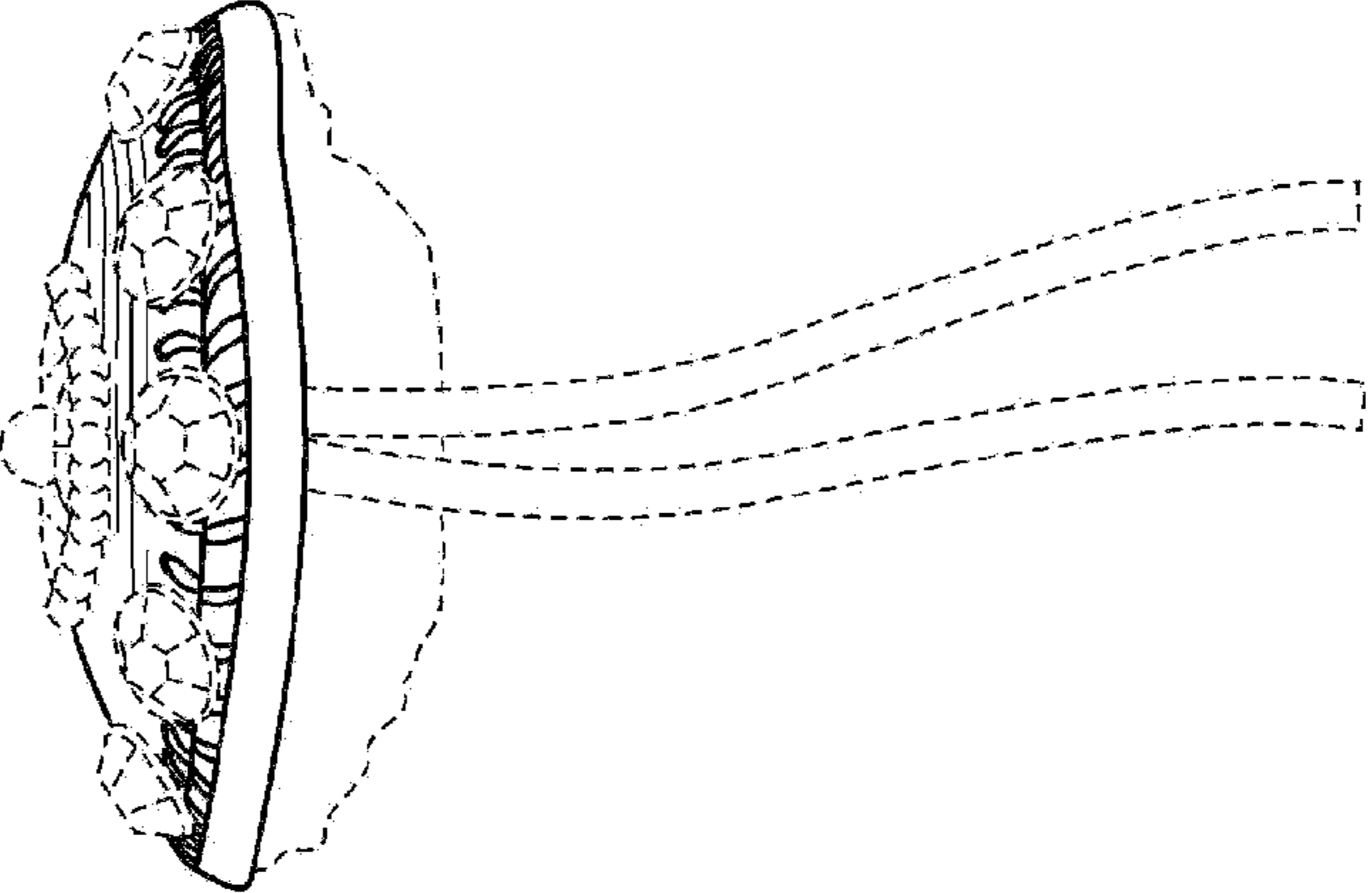

FIG. 15