



US00D573471S

(12) **United States Design Patent**  
**Seum et al.**

(10) **Patent No.:** **US D573,471 S**  
(45) **Date of Patent:** **\*\* Jul. 22, 2008**

(54) **PERFUME BOTTLE**

(75) Inventors: **Michael Thomas Seum**, Cincinnati, OH (US); **Matthew David Day**, San Francisco, OH (US)

(73) Assignee: **The Procter & Gamble Company**, Cincinnati, OH (US)

(\*\*) Term: **14 Years**

(21) Appl. No.: **29/293,416**

(22) Filed: **Nov. 21, 2007**

|                |         |                |       |           |
|----------------|---------|----------------|-------|-----------|
| 4,607,756 A *  | 8/1986  | Courtman       | ..... | 215/6     |
| D285,903 S *   | 9/1986  | Courtman       | ..... | D9/540    |
| D289,858 S *   | 5/1987  | Duval et al.   | ..... | D9/529    |
| D304,549 S *   | 11/1989 | Desgrippes     | ..... | D9/529    |
| D307,392 S *   | 4/1990  | Weckman        | ..... | D9/534 X  |
| D315,095 S *   | 3/1991  | Wright         | ..... | D9/418 X  |
| D387,093 S *   | 12/1997 | Liang          | ..... | D19/85    |
| D405,608 S *   | 2/1999  | Sumner, III    | ..... | D3/266    |
| D470,770 S *   | 2/2003  | Machado et al. | ..... | D9/537 X  |
| D521,388 S *   | 5/2006  | Andoh          | ..... | D9/560 X  |
| D521,389 S *   | 5/2006  | Andoh          | ..... | D9/560 X  |
| D523,346 S *   | 6/2006  | Andoh          | ..... | D9/543    |
| D536,254 S *   | 2/2007  | Ashiwa         | ..... | D9/529    |
| 7,234,592 B2 * | 6/2007  | Ide et al.     | ..... | 220/23.88 |
| D549,099 S *   | 8/2007  | Edwards        | ..... | D9/517 X  |

\* cited by examiner

**Related U.S. Application Data**

(63) Continuation-in-part of application No. 29/285,649, filed on Apr. 4, 2007.

*Primary Examiner*—Carol Rademaker

(74) *Attorney, Agent, or Firm*—Amy I. Ahn-Roll

(51) **LOC (8) Cl.** ..... **09-01**

(52) **U.S. Cl.** ..... **D9/516; D9/530; D9/534; D9/548; D9/560**

(58) **Field of Classification Search** ..... D9/682, D9/686–688, 690, 692–694, 517, 522, 529, D9/530, 534–535, 537, 540, 543–544, 548–549, D9/560, 572–573, 575, 418; D7/591, 596–598; 215/382–385; 220/660, 662, 669, 675  
See application file for complete search history.

(57) **CLAIM**

The ornamental design for a perfume bottle, as shown and described.

(56) **References Cited**

**U.S. PATENT DOCUMENTS**

|              |         |                    |       |          |
|--------------|---------|--------------------|-------|----------|
| D20,656 S *  | 3/1891  | Dawes              | ..... | D9/550 X |
| D23,100 S *  | 3/1894  | Fay et al.         | ..... | D9/522   |
| D79,958 S *  | 11/1929 | De Wagner          | ..... | D9/540   |
| D123,212 S * | 10/1940 | Lumley             | ..... | D34/1    |
| D224,701 S * | 9/1972  | Wright             | ..... | D9/529 X |
| D246,156 S * | 10/1977 | Muscatiello et al. | ..... | D9/534 X |
| D280,077 S * | 8/1985  | Lemaire            | ..... | D9/522   |
| D280,927 S * | 10/1985 | Iwasaki et al.     | ..... | D9/548 X |

**DESCRIPTION**

FIG. 1 is a top, front, and left side perspective view of a first embodiment of a perfume bottle according to the present invention;

FIG. 2 is a front elevational view thereof;

FIG. 3 is a left side elevational view thereof;

FIG. 4 is a rear elevational view thereof;

FIG. 5 is a right side elevational view thereof;

FIG. 6 is a top plan view thereof; and,

FIG. 7 is a bottom plan view thereof.

The broken lines shown in the drawings are for illustrative purposes only and form no part of the claimed design.

**1 Claim, 4 Drawing Sheets**

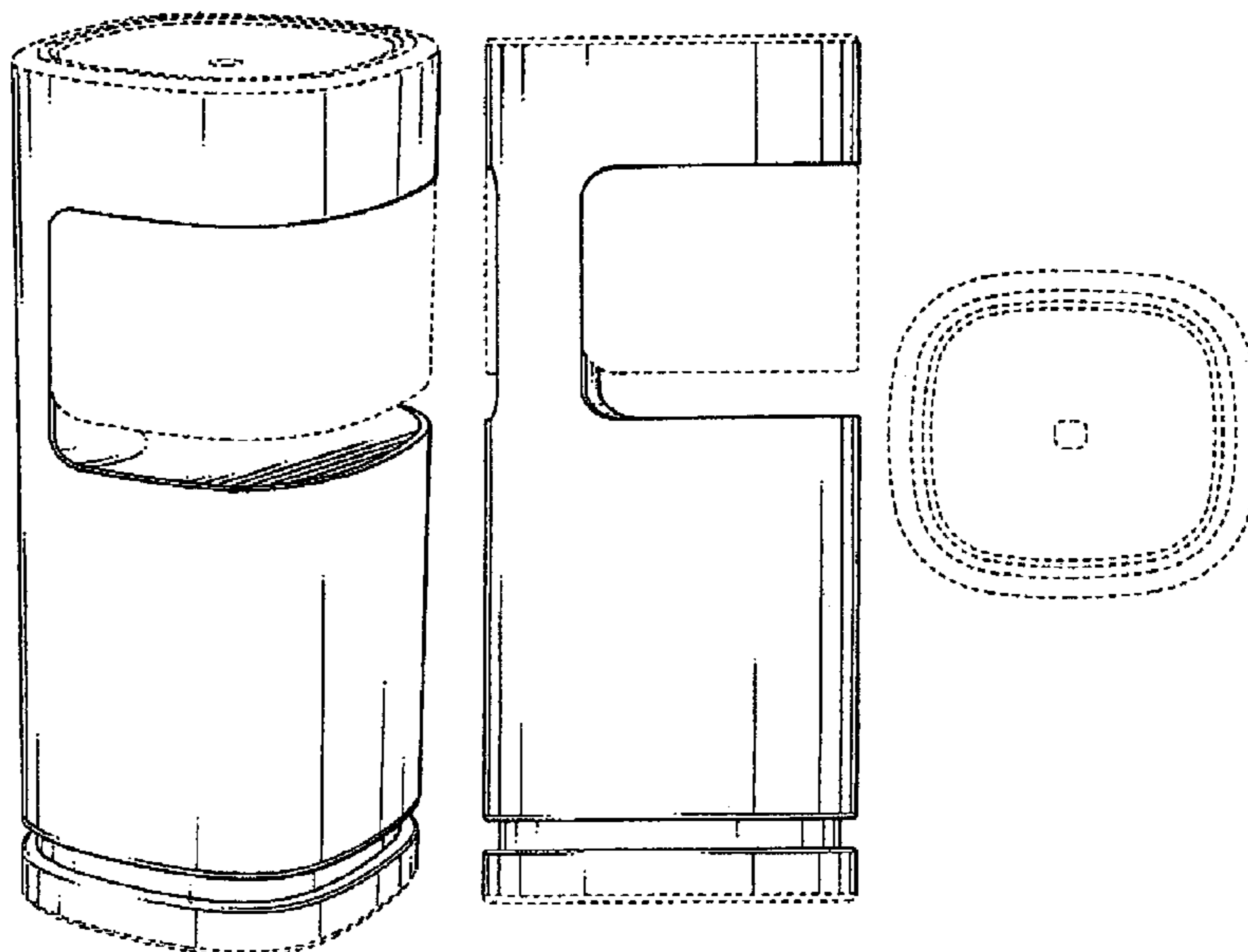

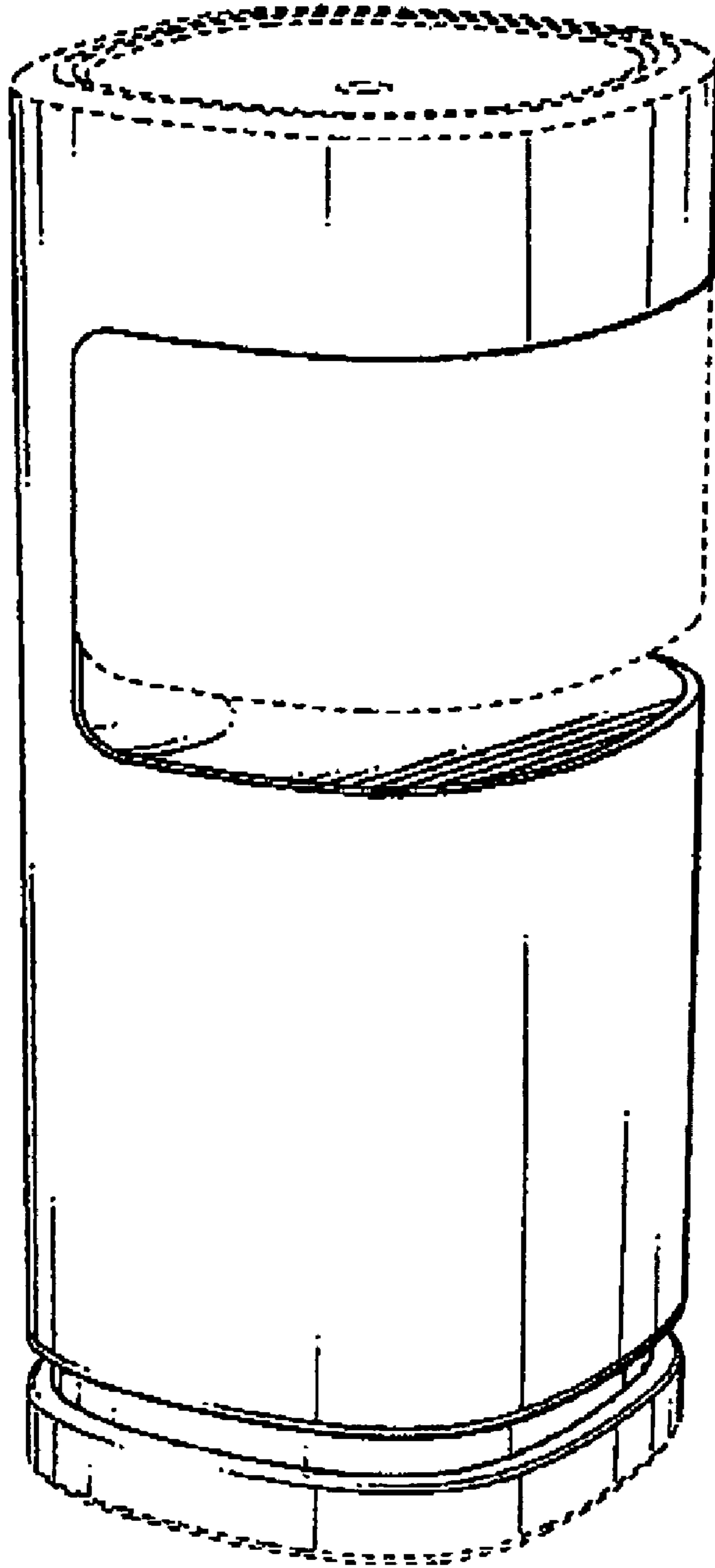

FIG. 1

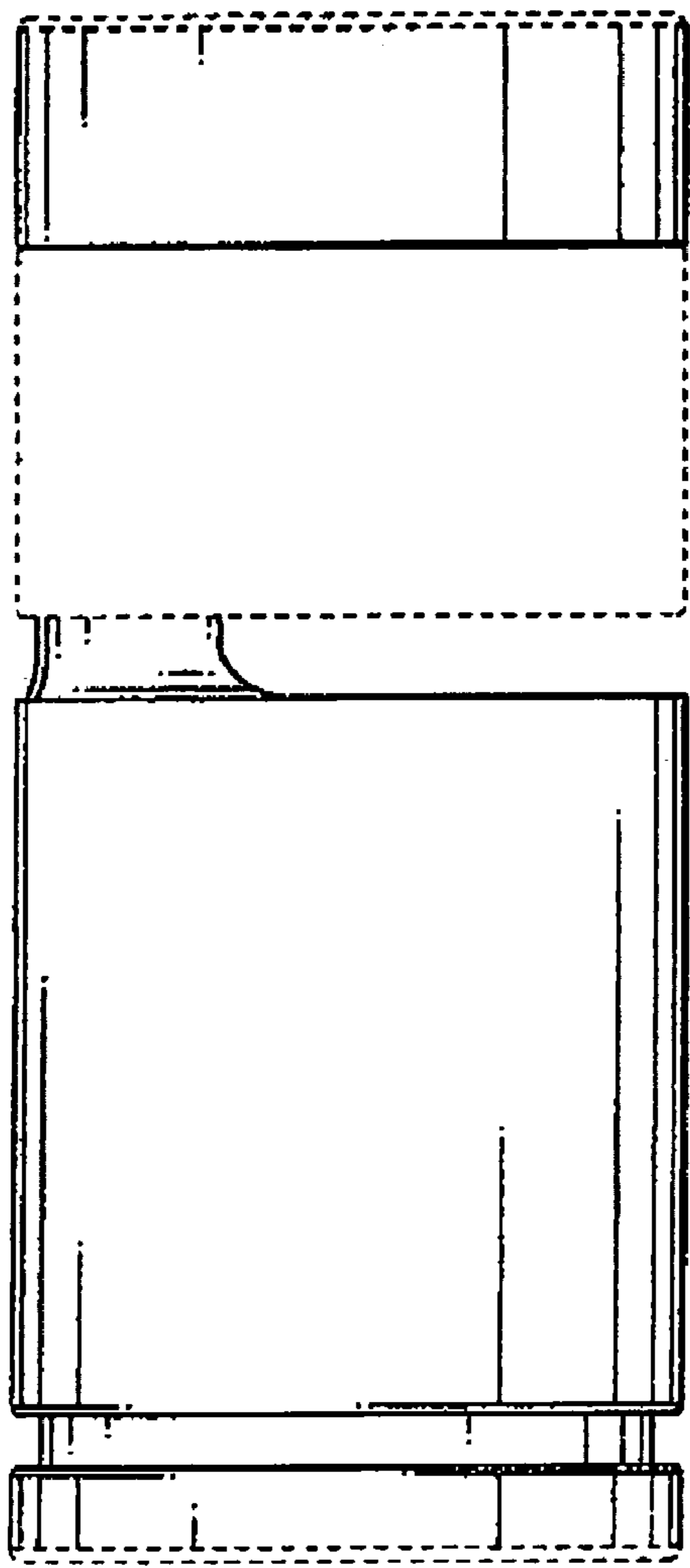

FIG. 2

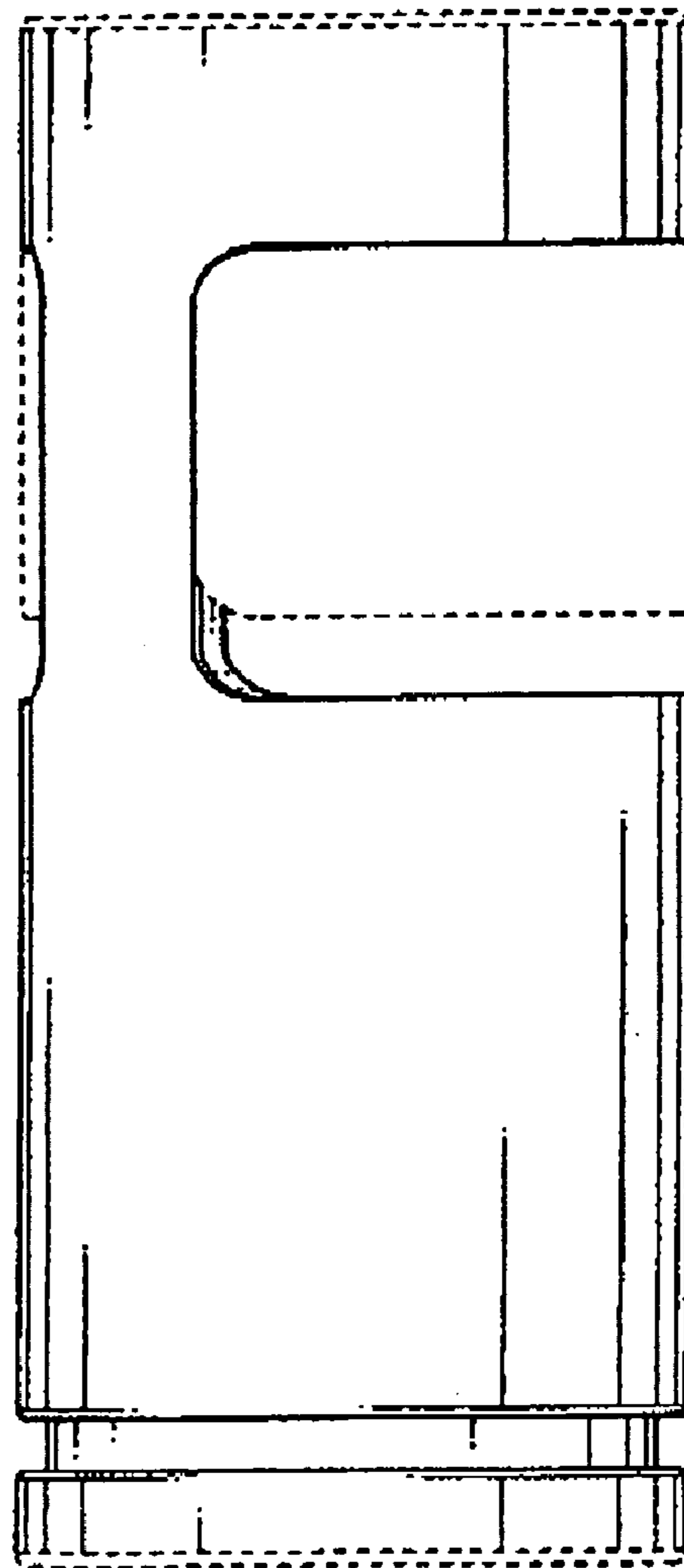

FIG. 3

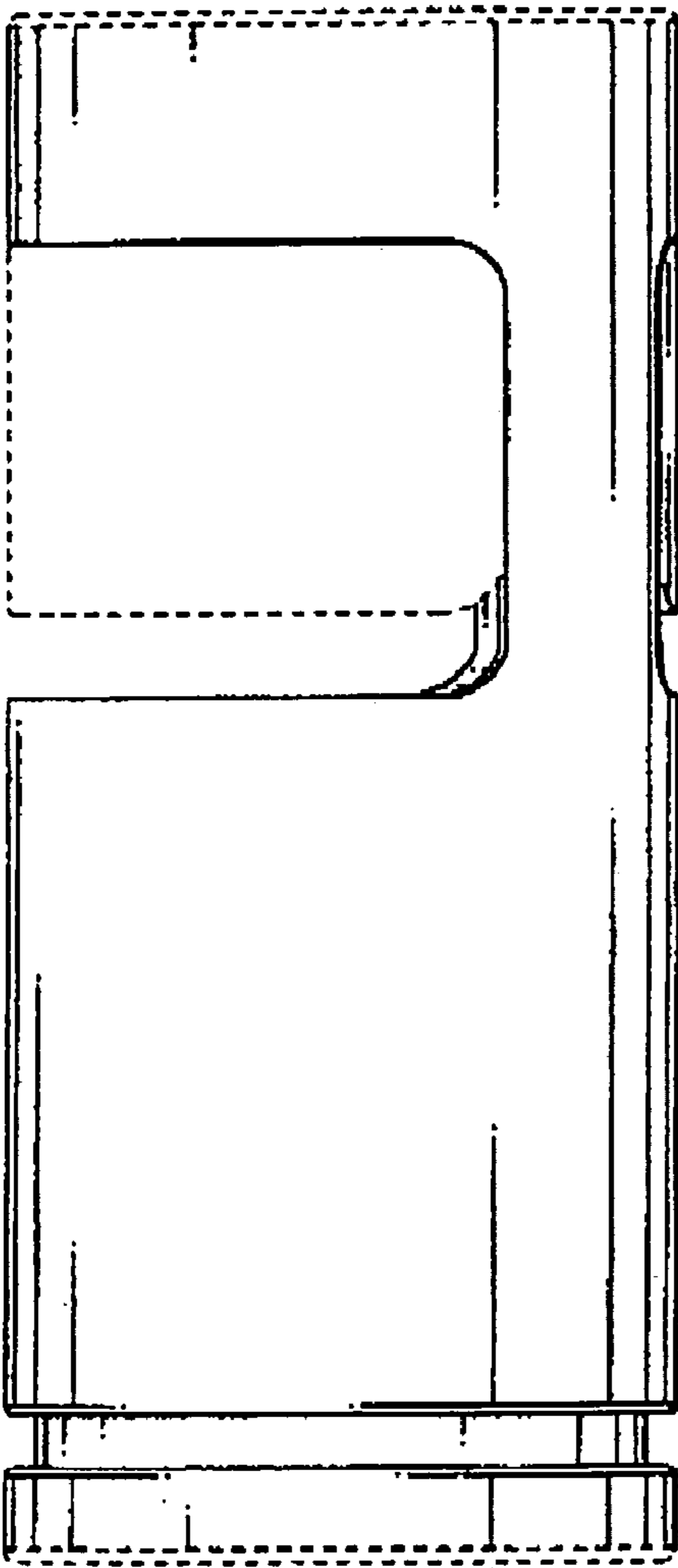

FIG. 4

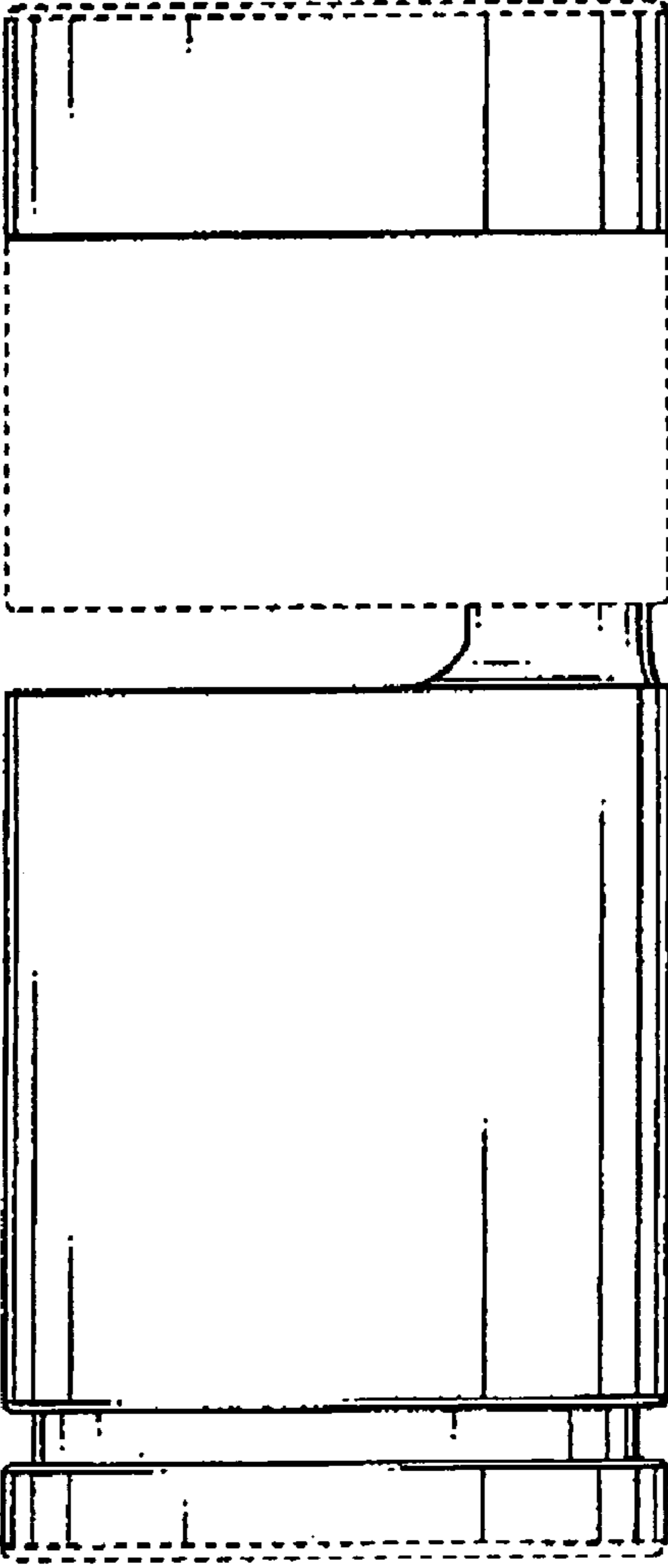

FIG. 5

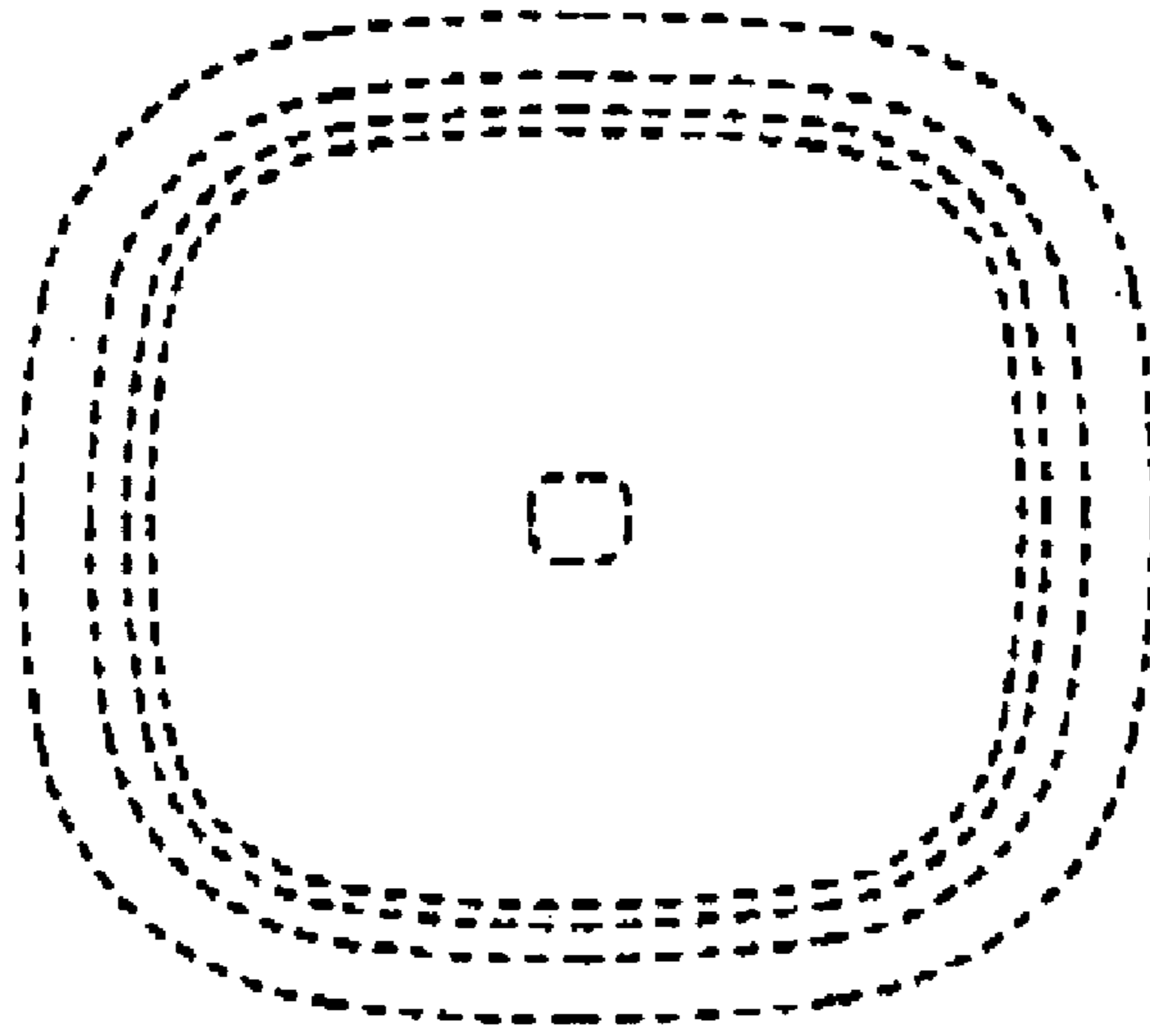

FIG. 6

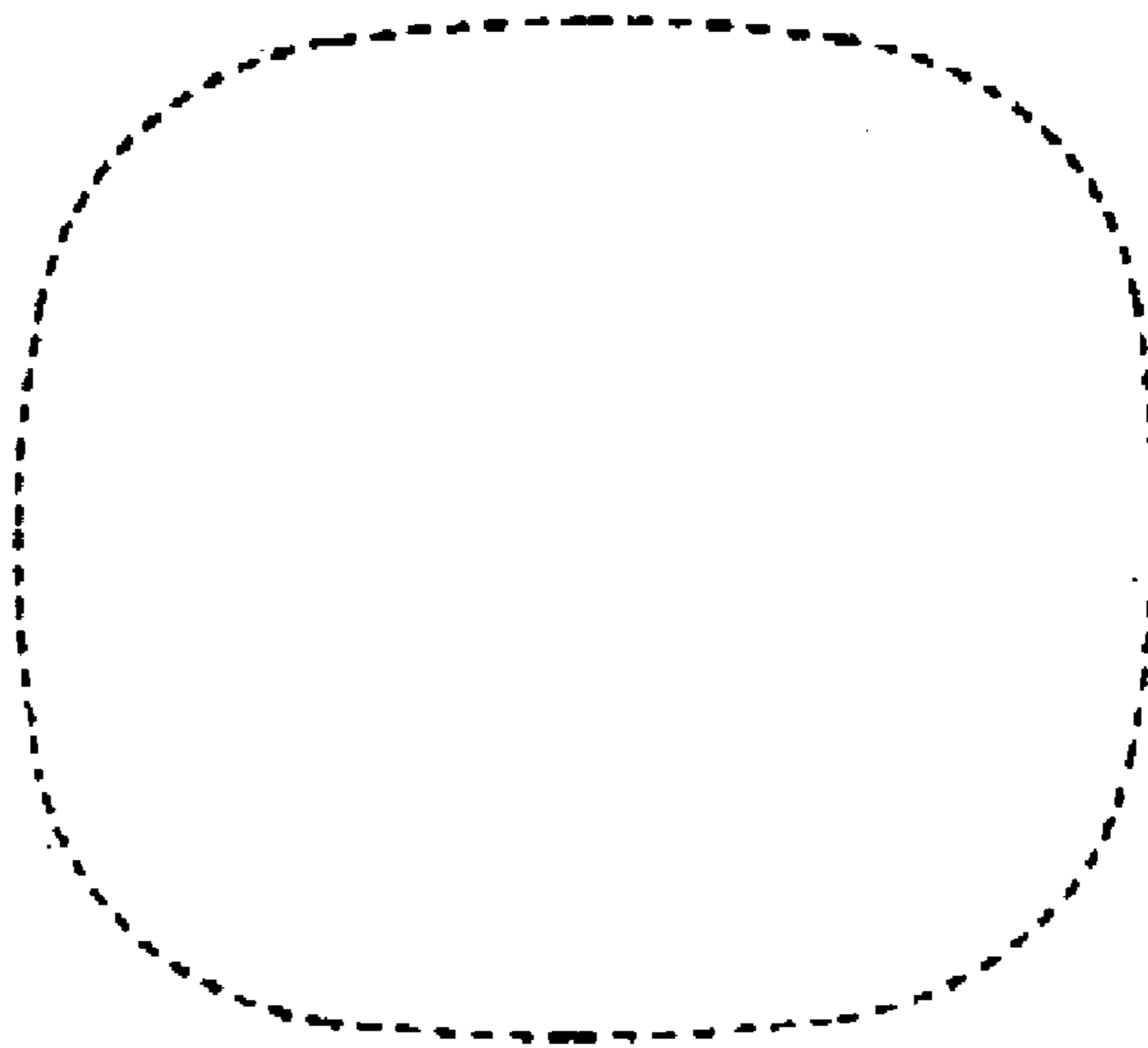

FIG. 7