



US00D573440S

(12) **United States Design Patent**  
**Johnson et al.**

(10) **Patent No.:** **US D573,440 S**  
(45) **Date of Patent:** **\*\* Jul. 22, 2008**

(54) **LEVER OF LOCKING MECHANISM**

(75) Inventors: **Eric M. Johnson**, Brooklyn, NY (US);  
**Ben Michaeli**, South Setauket, NY (US);  
**Carl Thelemann**, East Islip, NY (US)

(73) Assignee: **Symbol Technologies, Inc.**, Holtsville,  
NY (US)

(\*\*) Term: **14 Years**

(21) Appl. No.: **29/276,000**

(22) Filed: **Jan. 11, 2007**

(51) **LOC (8) Cl.** ..... **08-07**

(52) **U.S. Cl.** ..... **D8/330**

(58) **Field of Classification Search** ..... D8/330-348;  
D13/107, 108, 250-253; D14/125-130,  
D14/140-151; 292/113, 66, 24, 31, 80-89,  
292/303, 240; 185/80, 81, 91, 92, 311, 312,  
185/317, 14; 74/143, 431, 444

See application file for complete search history.

(56) **References Cited**

**U.S. PATENT DOCUMENTS**

D29,385 S \* 9/1898 Taylor ..... D8/343  
D416,466 S \* 11/1999 Leonowich ..... D8/331  
D429,621 S \* 8/2000 Rivera ..... D8/343

D444,371 S \* 7/2001 Leonowich ..... D8/331  
6,944,015 B1 \* 9/2005 Jenkins et al. .... 361/683  
D561,182 S \* 2/2008 Jenkins et al. .... D14/253

\* cited by examiner

*Primary Examiner*—Mitchell I Siegel  
(74) *Attorney, Agent, or Firm*—Fay Kaplun & Marcin, LLP

(57) **CLAIM**

The ornamental design for a lever of locking mechanism, as shown and described.

**DESCRIPTION**

FIG. 1 is a perspective view a lever of locking mechanism showing our new design;

FIG. 2 is a top plan view thereof;

FIG. 3 is a front elevational view thereof;

FIG. 4 is a bottom plan view thereof;

FIG. 5 is a rear elevational view thereof;

FIG. 6 is an end view thereof; and,

FIG. 7 is an opposite end view of FIG. 6.

The broken lines shown in FIGS. 1-7 are included for illustrative purposes only and form no part of the claimed design.

**1 Claim, 3 Drawing Sheets**

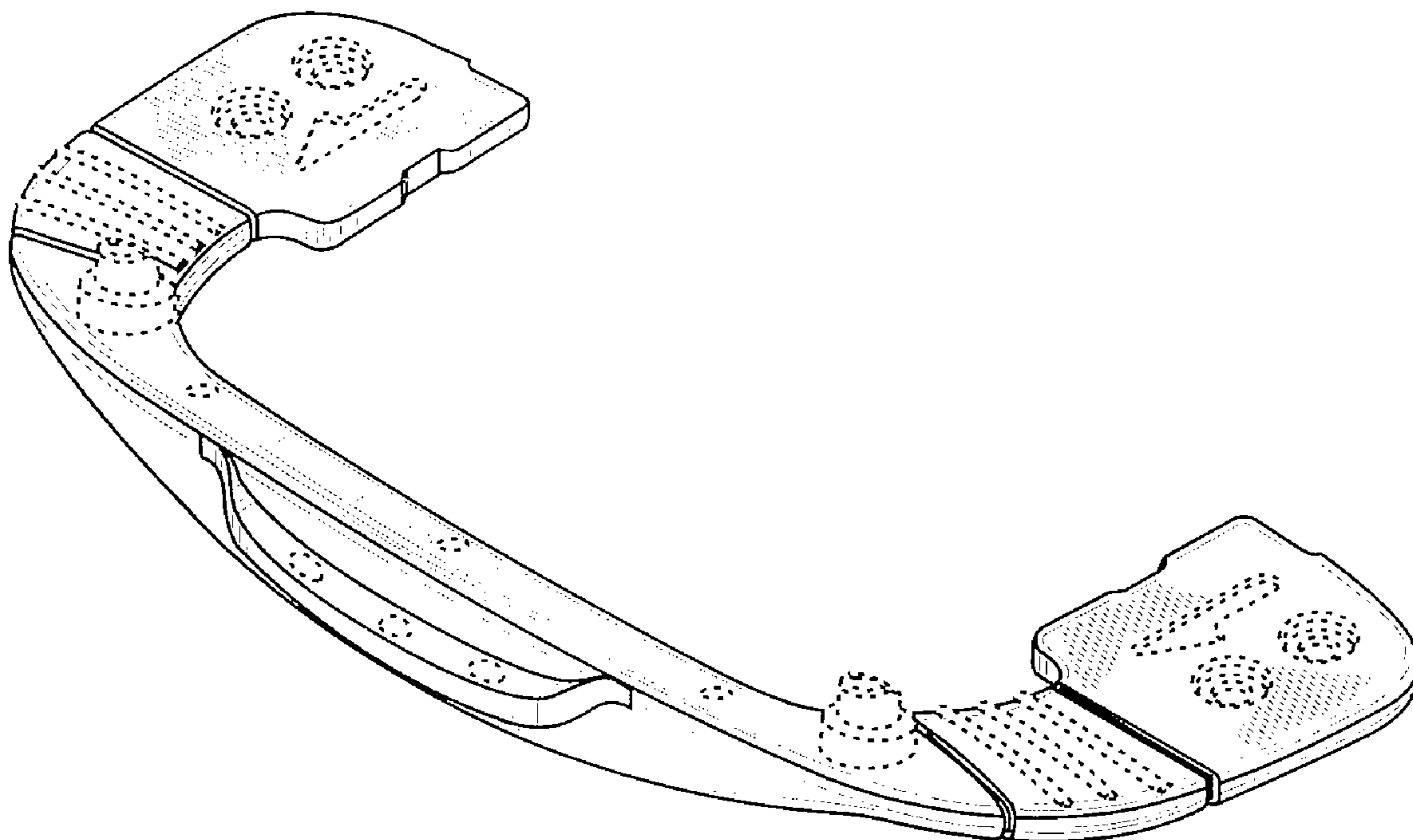

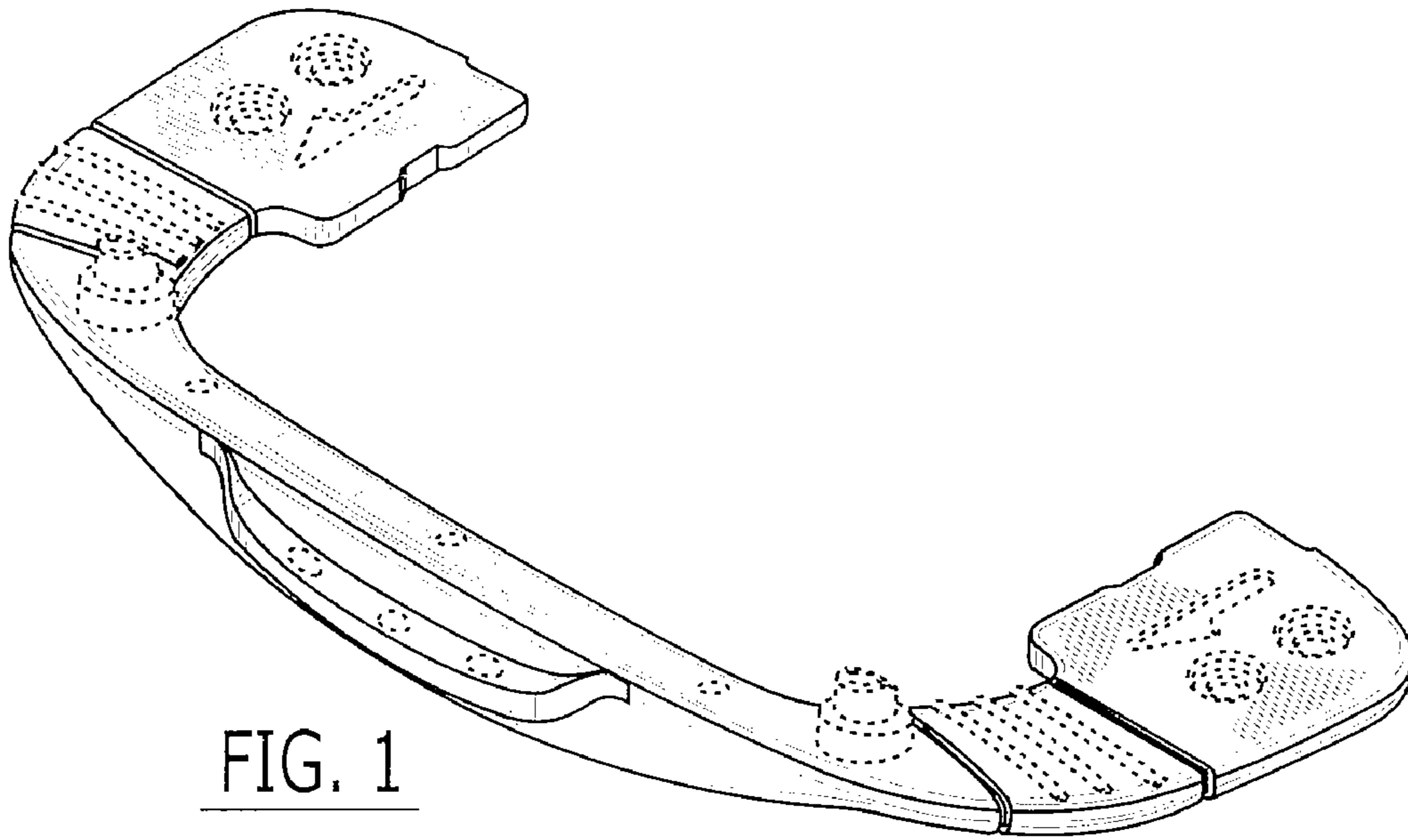

FIG. 1

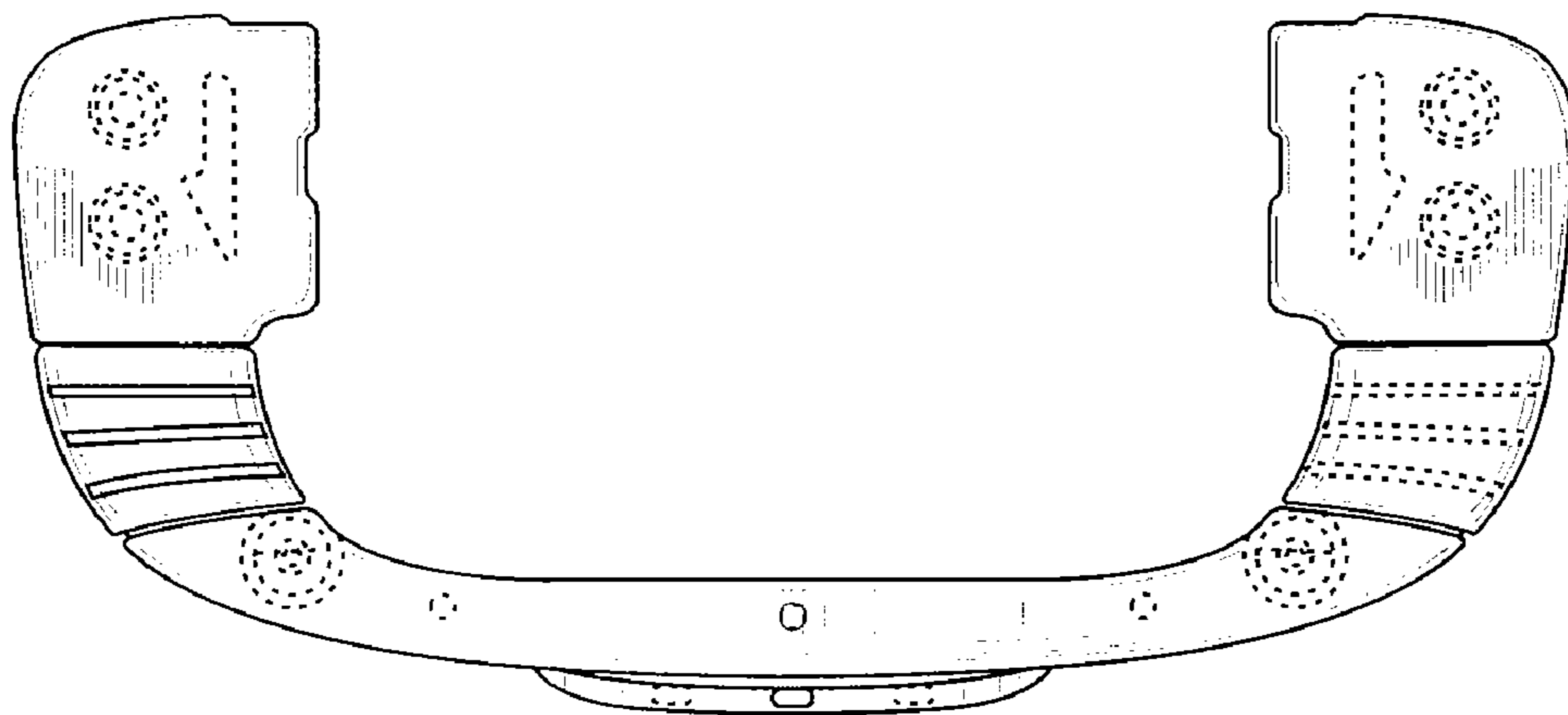

FIG. 2

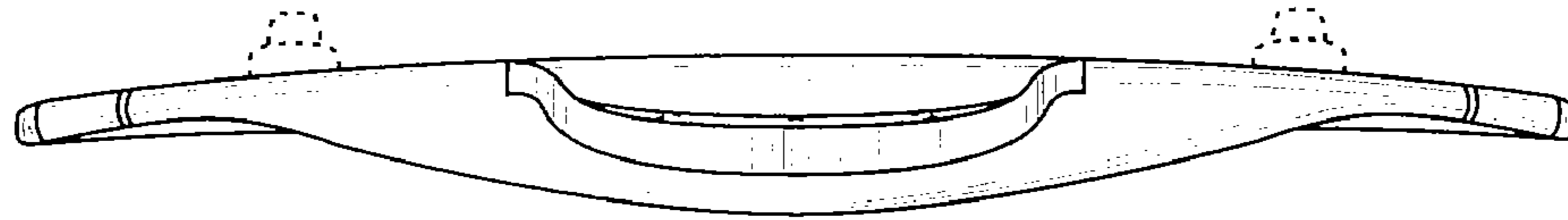

FIG. 3

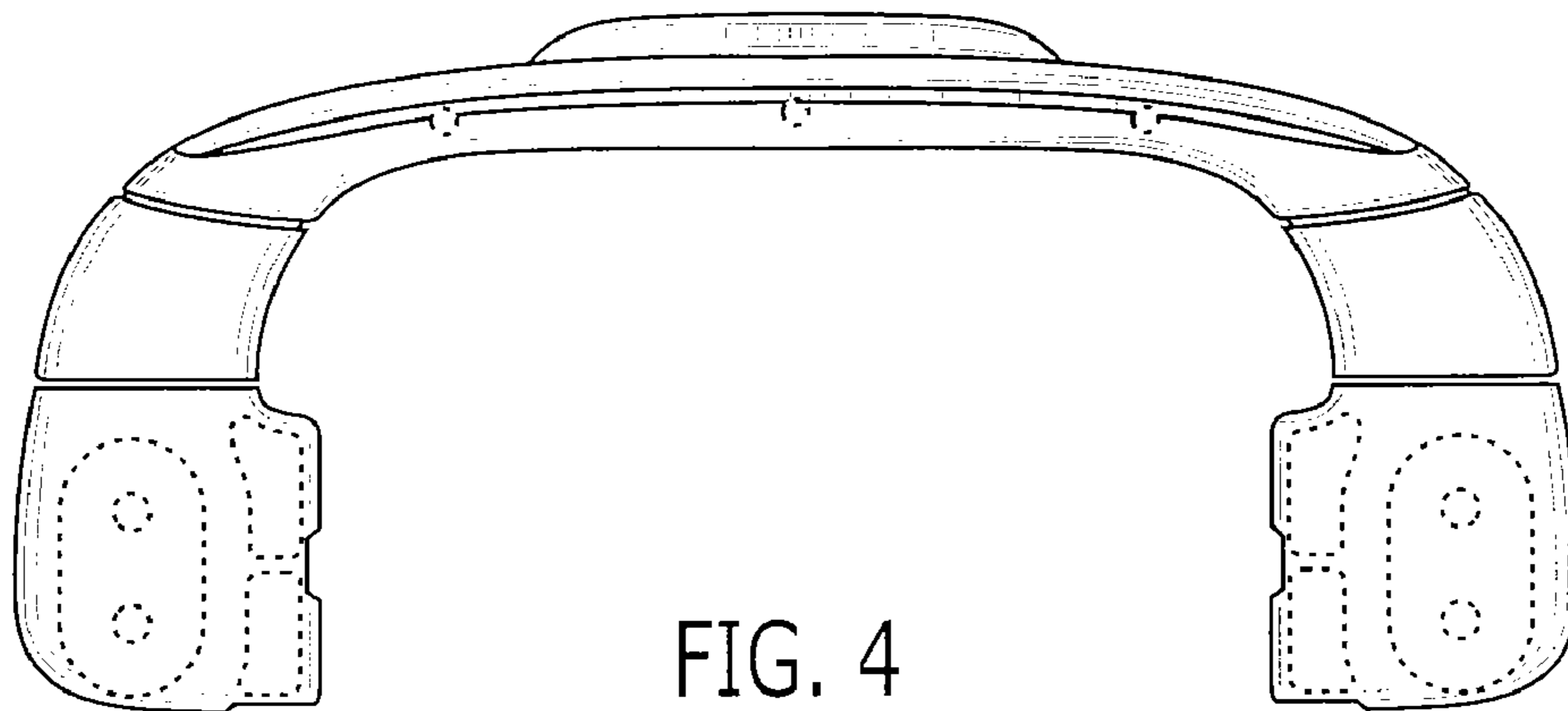

FIG. 4

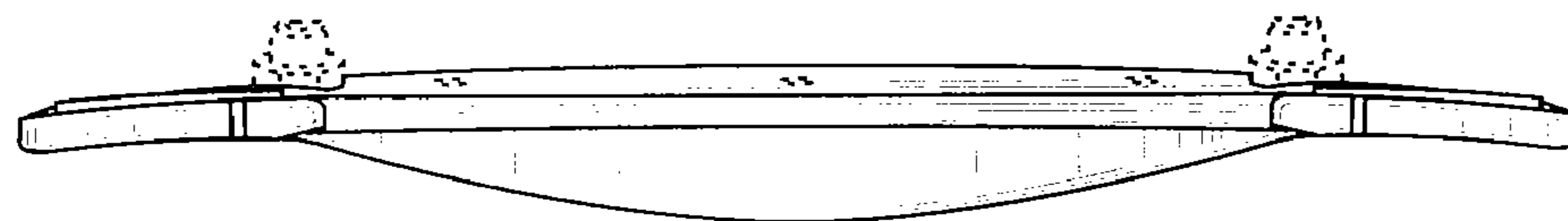

FIG. 5

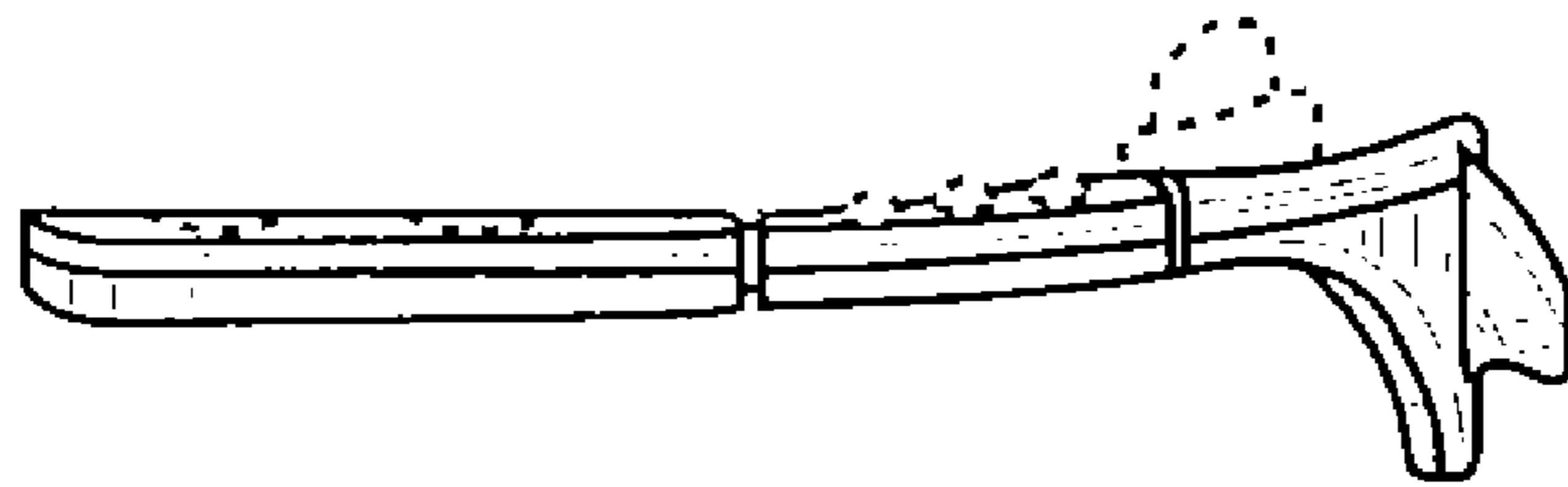

FIG. 6

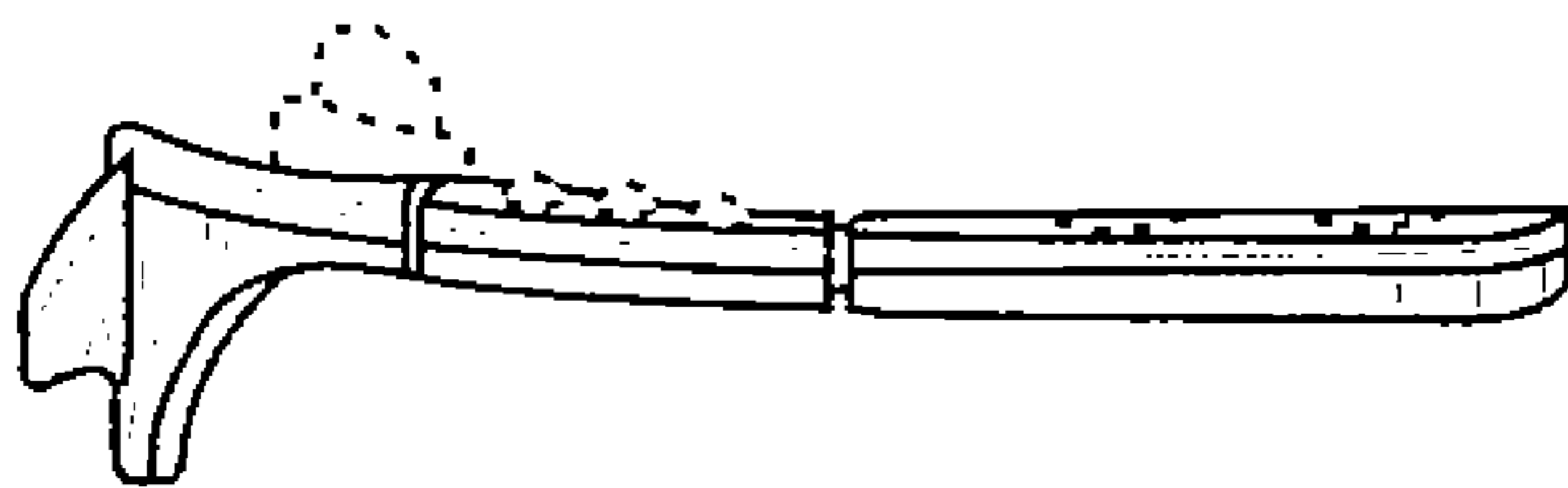

FIG. 7