



US00D573359S

(12) **United States Design Patent**
Weiss

(10) **Patent No.:** **US D573,359 S**
(45) **Date of Patent:** **** Jul. 22, 2008**

(54) **CHAIR**

(75) Inventor: **Per Weiss**, Randers (DK)

(73) Assignee: **Innovation V.S.A., Inc.**, Hanover, MD (US)

(**) Term: **14 Years**

(21) Appl. No.: **29/283,571**

(22) Filed: **Aug. 17, 2007**

(51) **LOC (8) Cl.** **06-01**

(52) **U.S. Cl.** **D6/335**

(58) **Field of Classification Search** D6/334,
D6/335, 341, 353, 360, 364, 367, 369, 371,
D6/376, 377, 379-381, 500-502; 297/445.1,
297/446.1; 5/12.1

See application file for complete search history.

(56) **References Cited**

U.S. PATENT DOCUMENTS

- D455,281 S * 4/2002 Andersen et al. D6/381
- D455,282 S * 4/2002 Andersen et al. D6/381
- D485,689 S * 1/2004 Boydak D6/335
- D486,311 S * 2/2004 Boydak D6/335

D490,996 S * 6/2004 Weiss et al. D6/381

* cited by examiner

Primary Examiner—Sandra Snapp

(74) *Attorney, Agent, or Firm*—Miles & Stockbridge PC;
James T. Carmichael

(57) **CLAIM**

The ornamental design for a chair, as shown and described.

DESCRIPTION

FIG. 1 is a perspective view of the chair showing the new design;

FIG. 2 is a front view thereof;

FIG. 3 is a left side view thereof;

FIG. 4 is a right side view thereof;

FIG. 5 is a top plan view thereof;

FIG. 6 is a bottom plan view thereof;

FIG. 7 is a back view thereof;

FIG. 8 is a perspective view thereof in a partially reclined position; and,

FIG. 9 is a perspective view thereof in a fully reclined position.

1 Claim, 2 Drawing Sheets

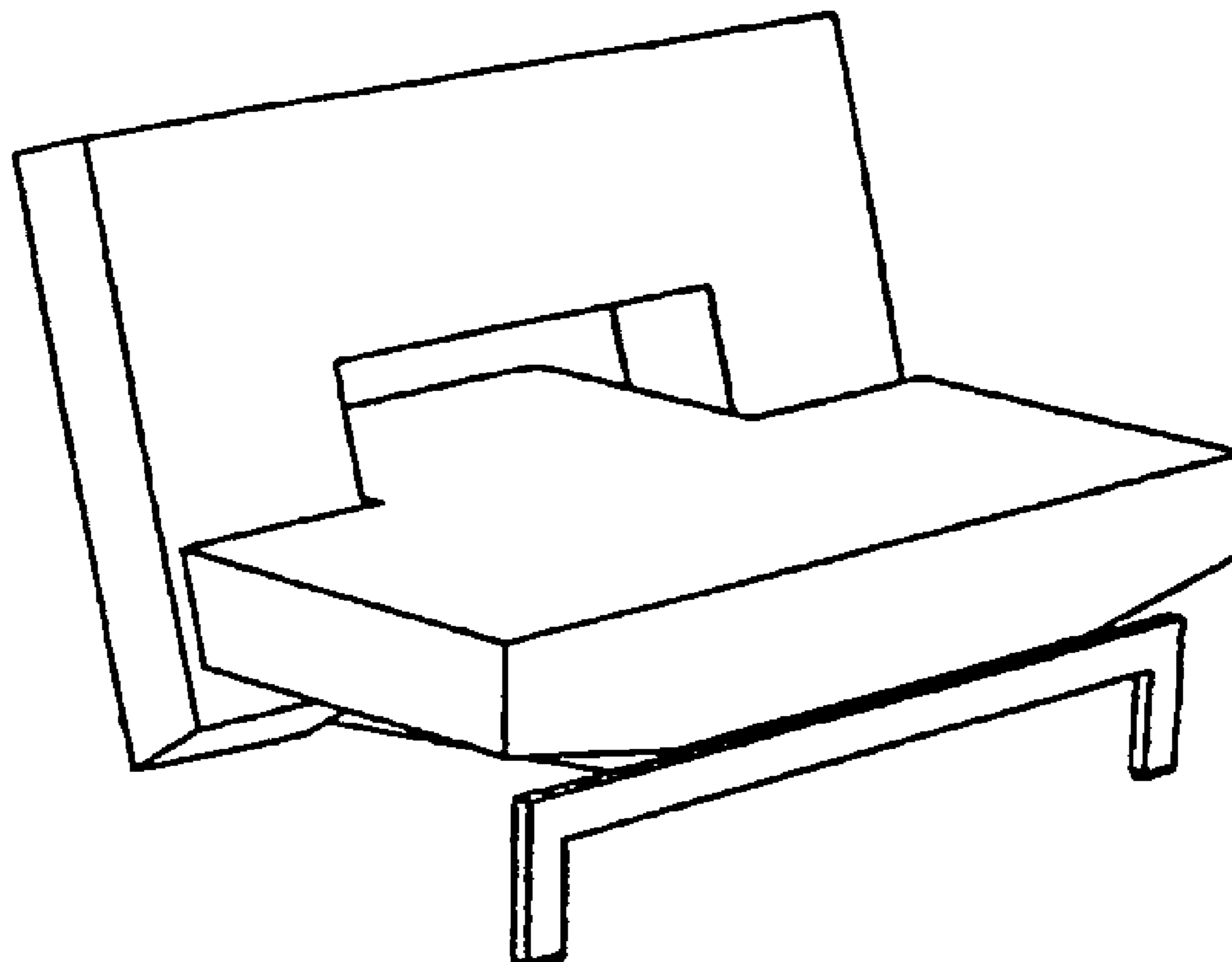

FIG. 1

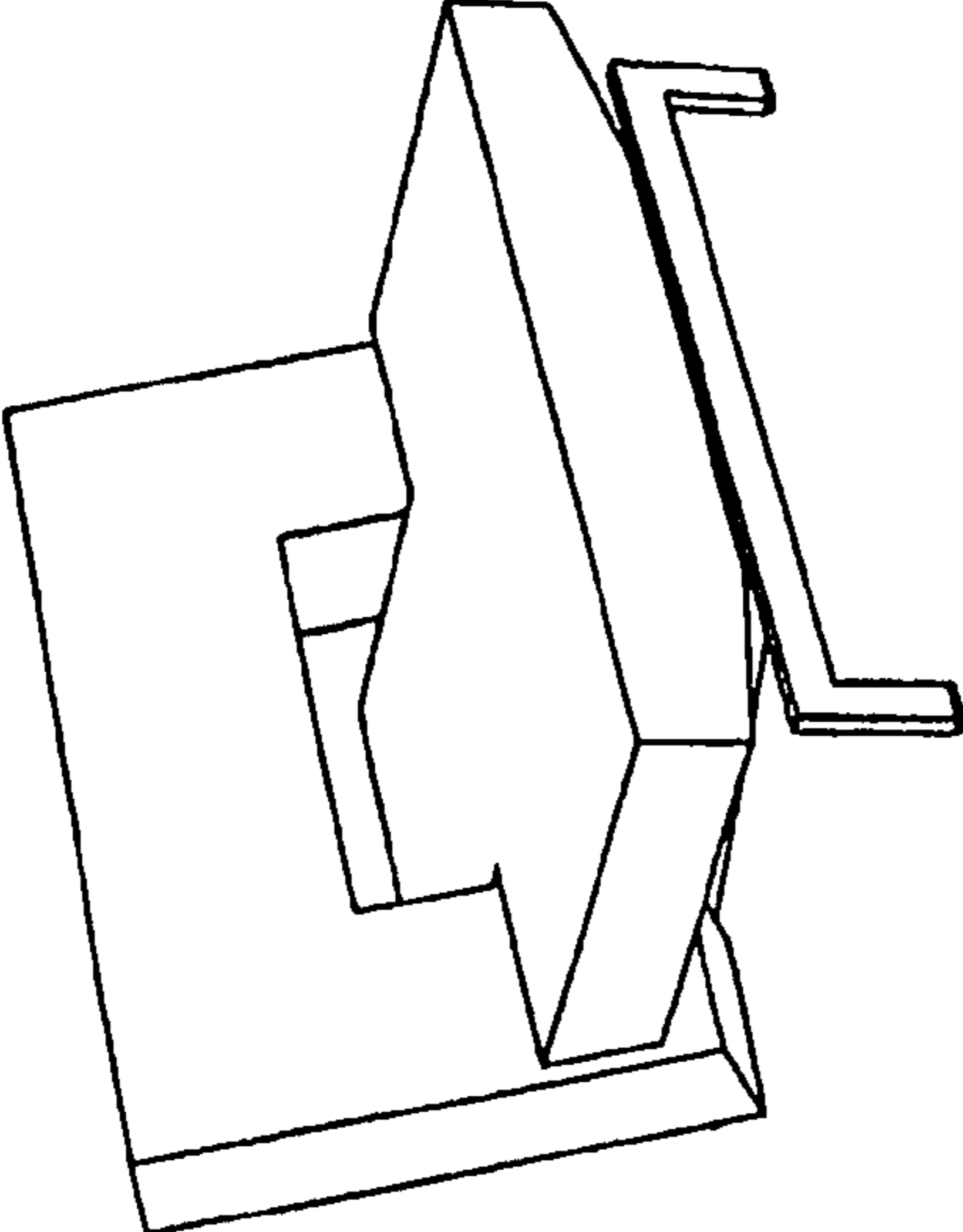

FIG. 8

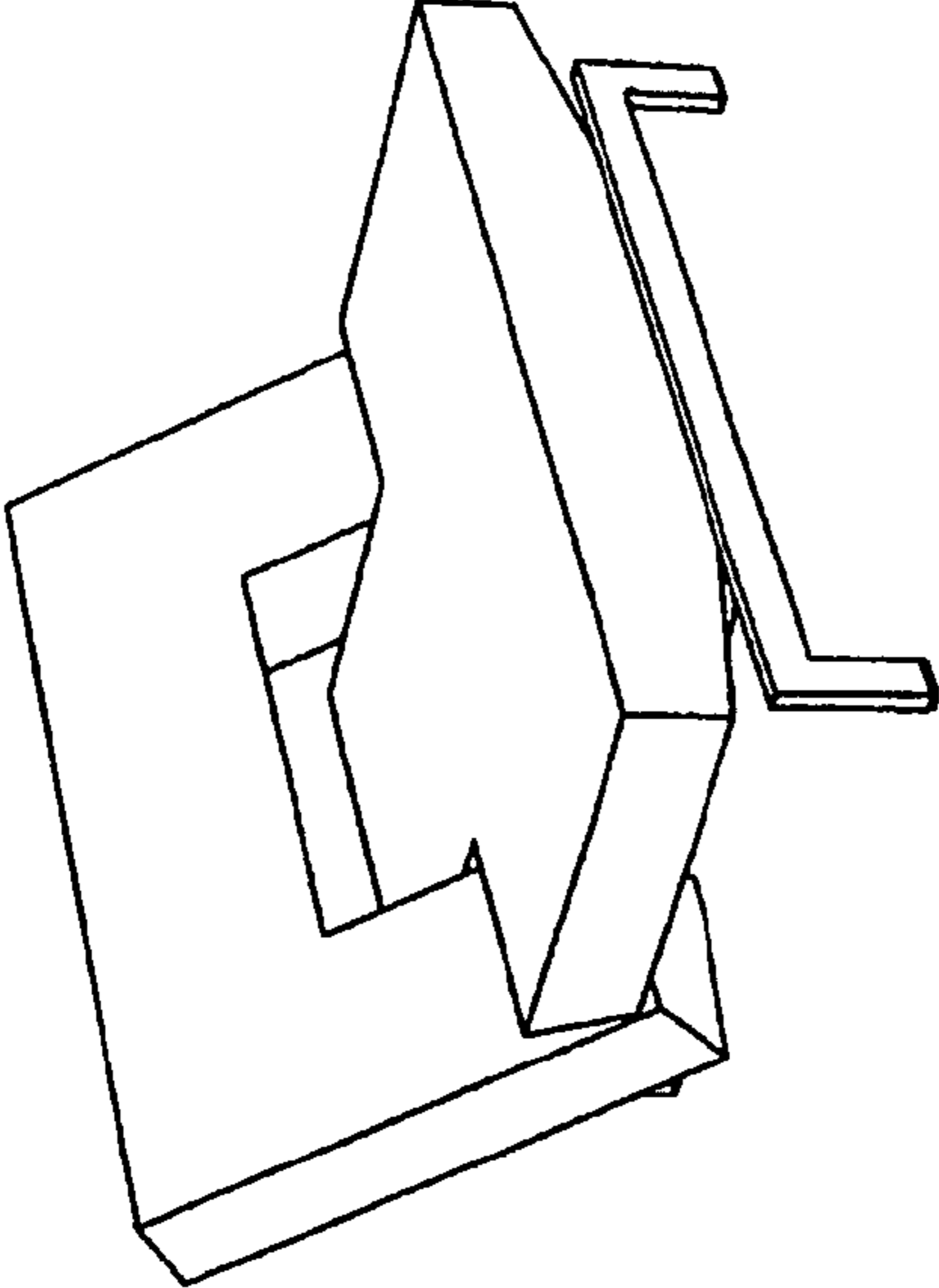

FIG. 9

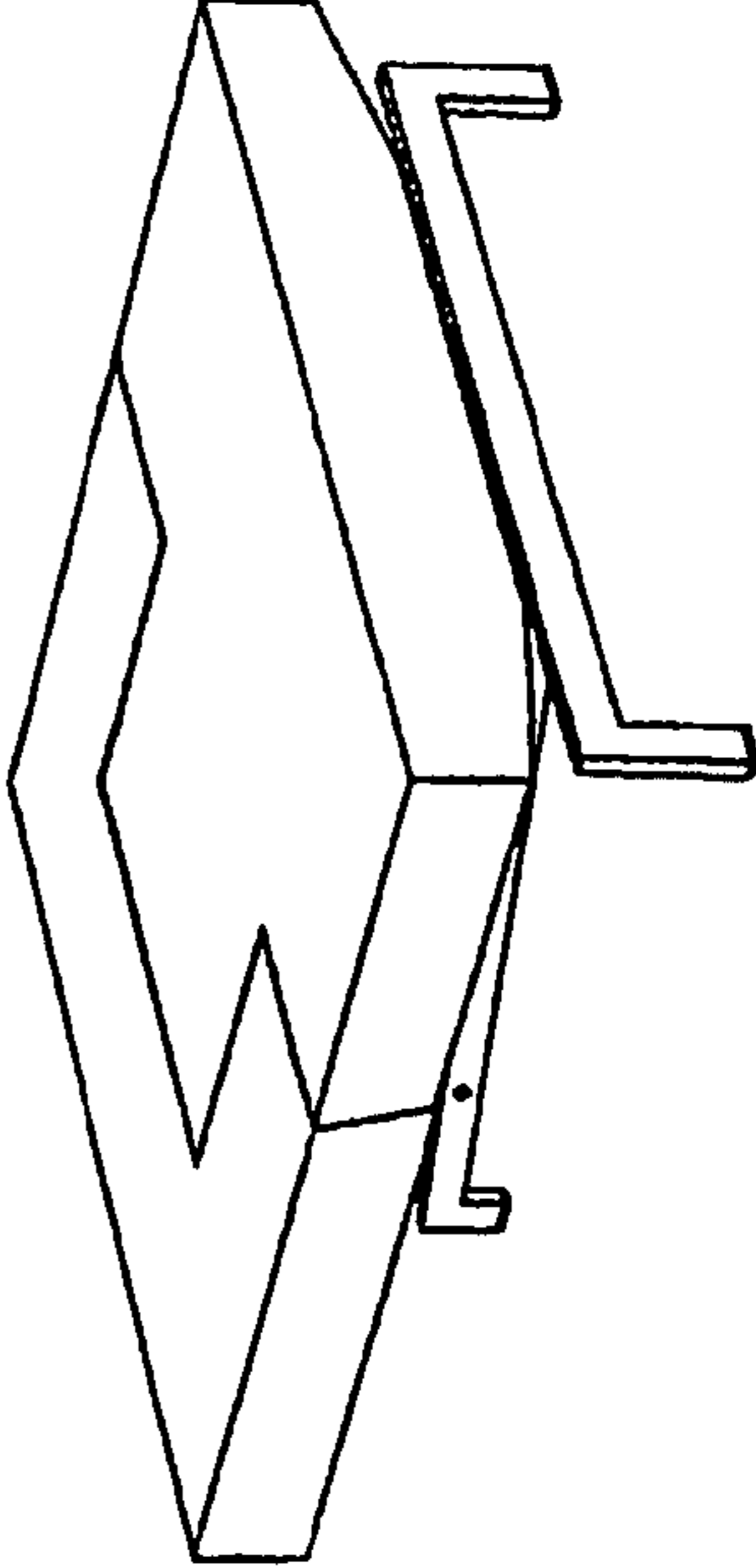

FIG. 2

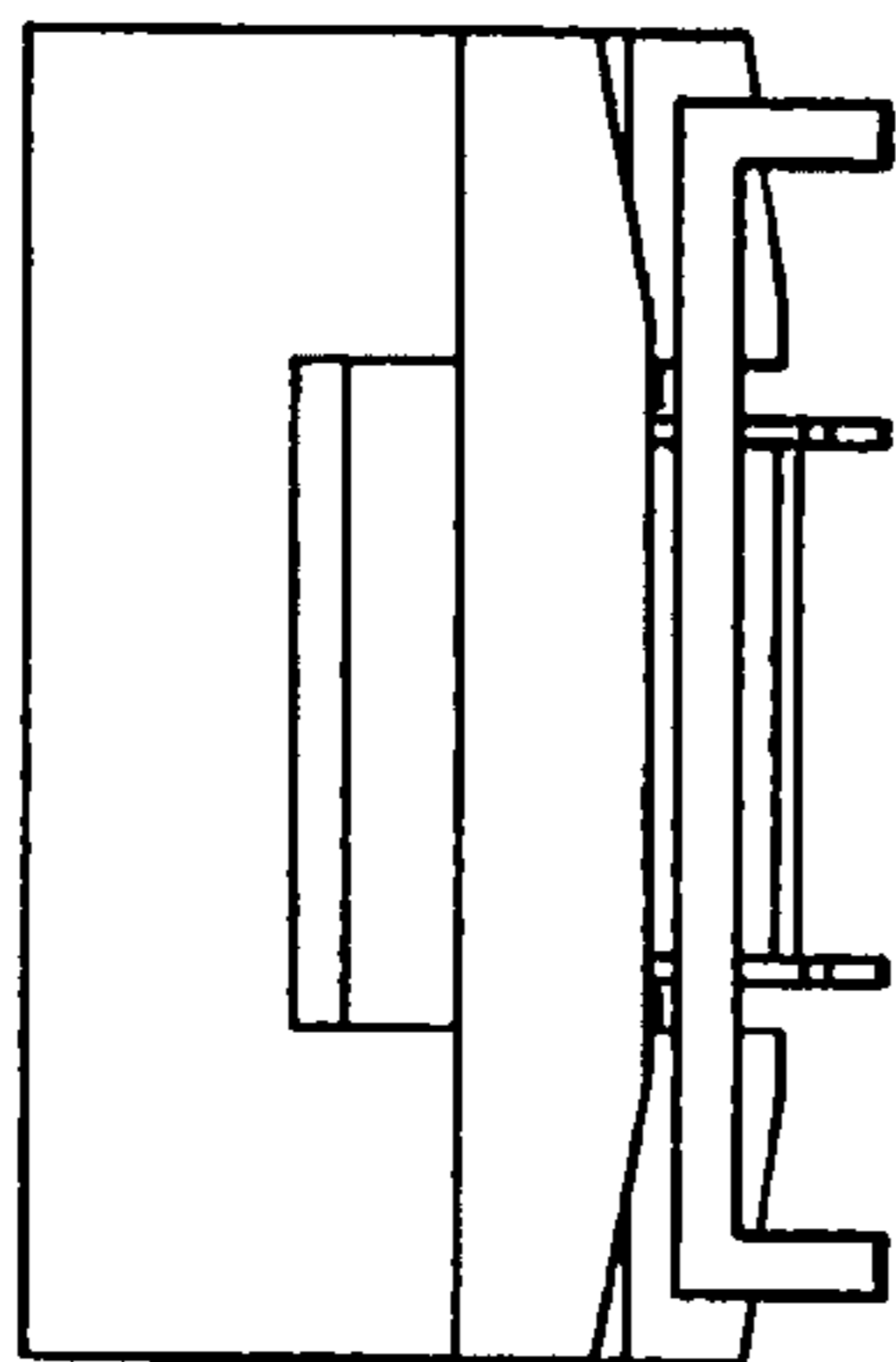

FIG. 3

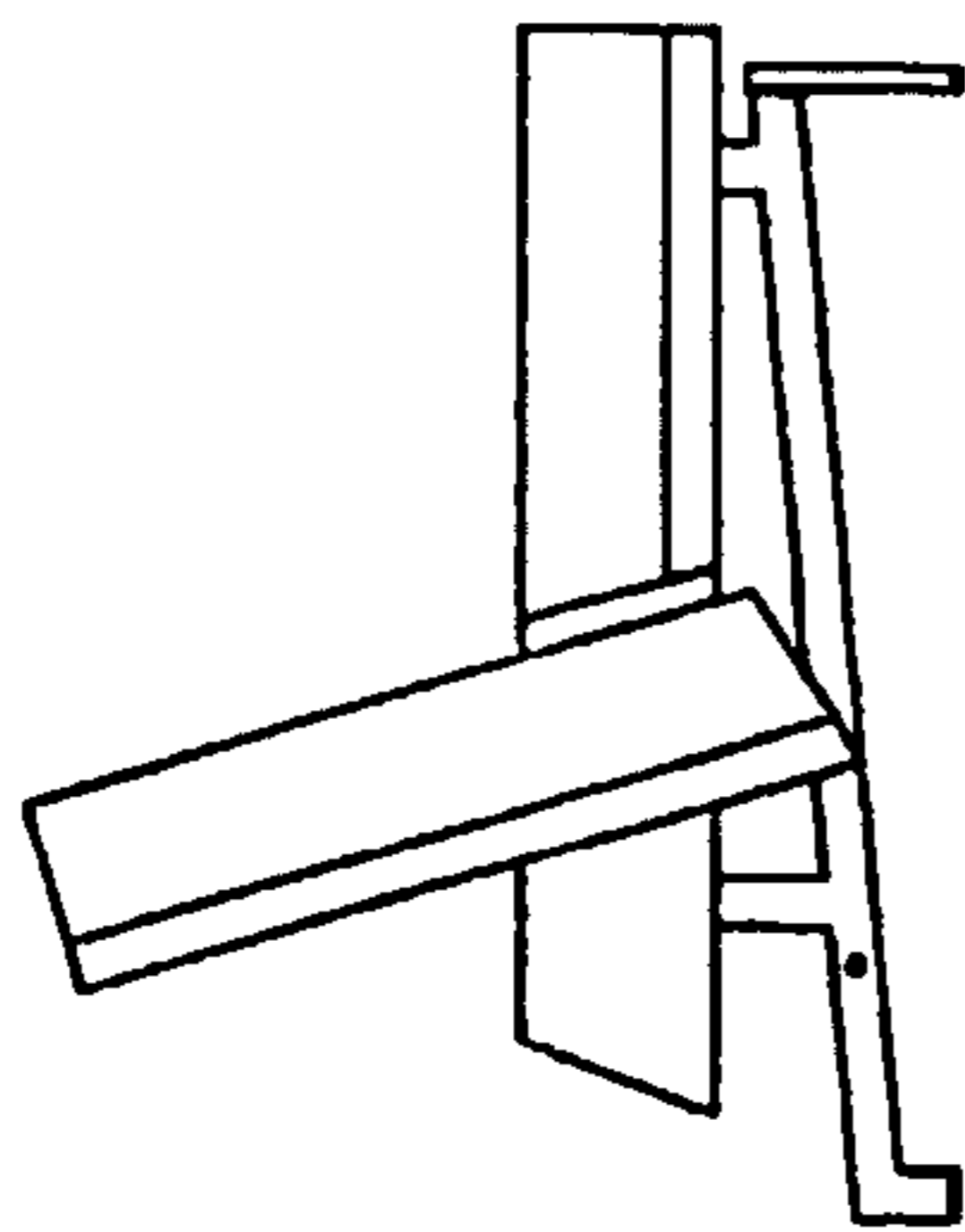

FIG. 4

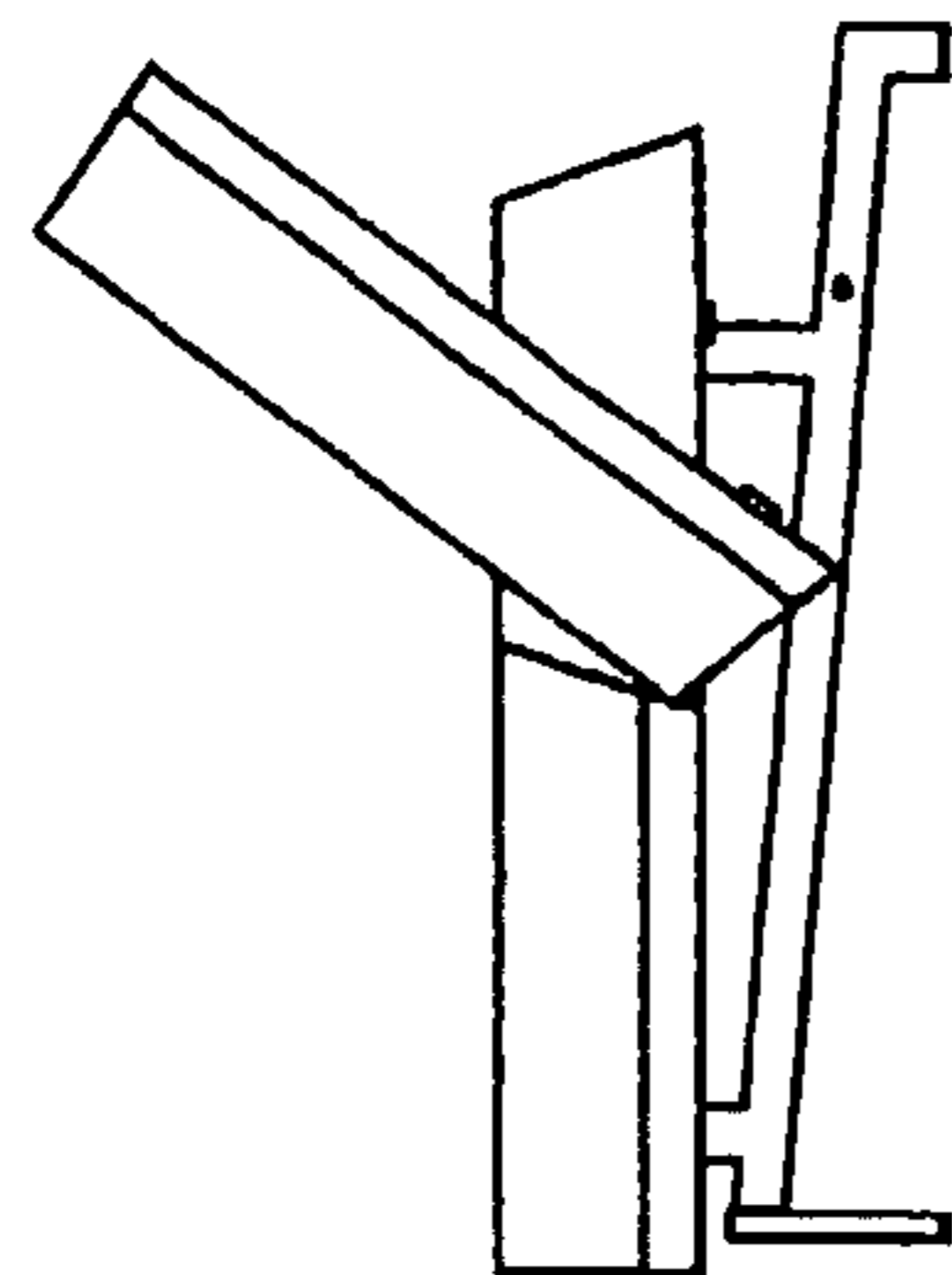

FIG. 5

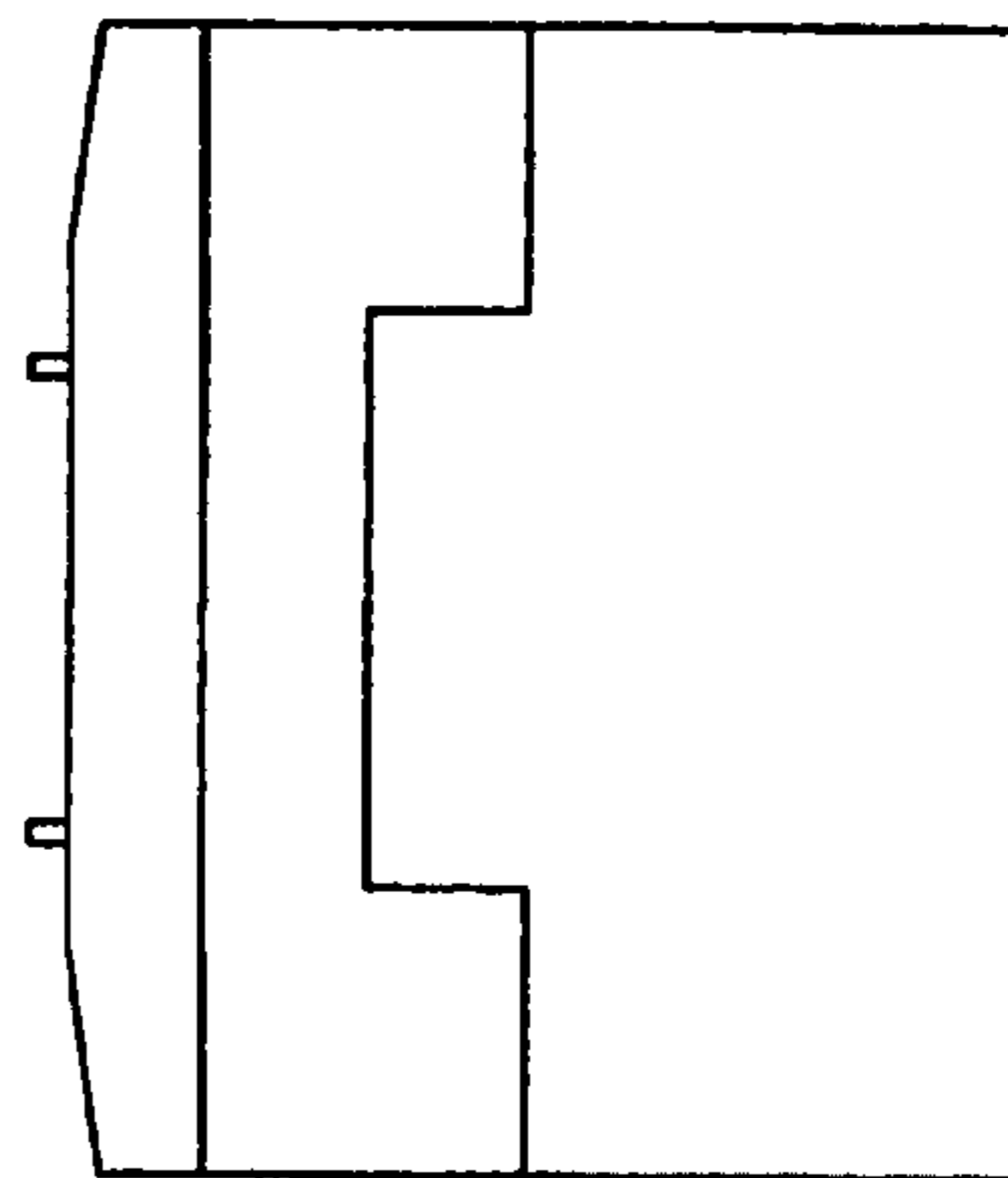

FIG. 6

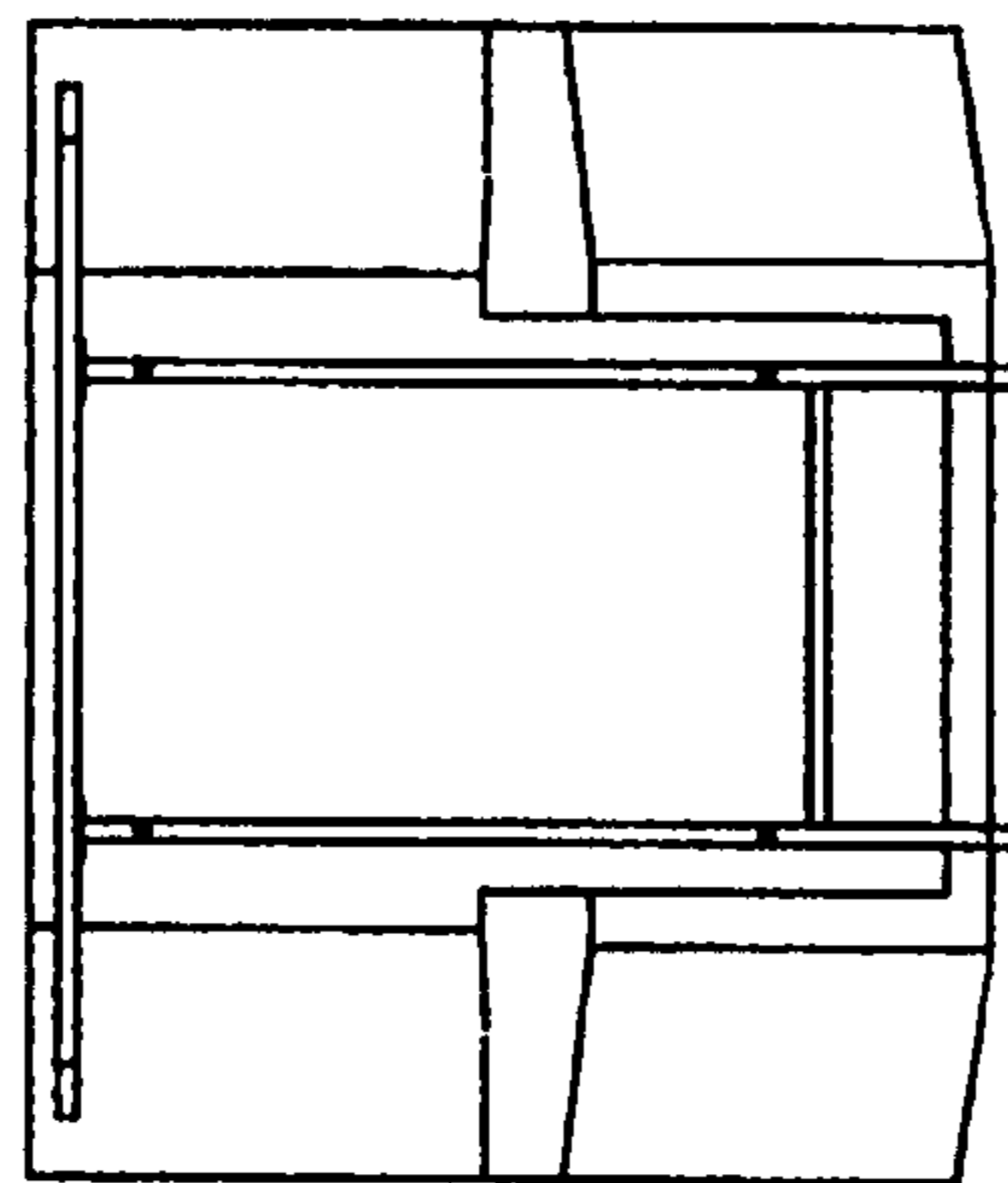
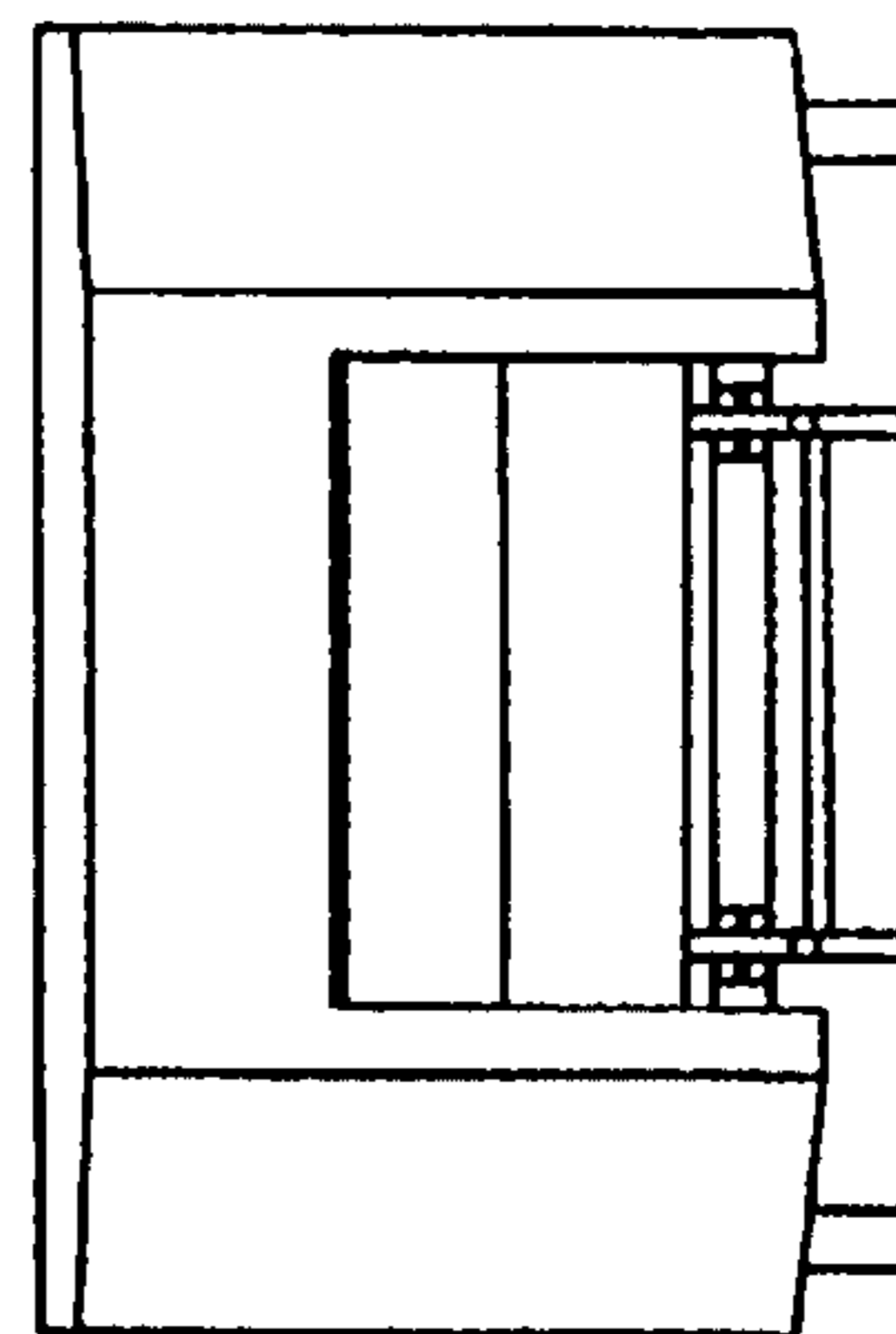

FIG. 7



UNITED STATES PATENT AND TRADEMARK OFFICE
CERTIFICATE OF CORRECTION

PATENT NO. : Des. 573,359 S
APPLICATION NO. : 29/283571
DATED : July 22, 2008
INVENTOR(S) : Per Weiss

Page 1 of 1

It is certified that error appears in the above-identified patent and that said Letters Patent is hereby corrected as shown below:

On the Title Page:

Item (73) Assignee: should read as follows: Innovation U.S.A., Inc., Hanover, MD (US)

Signed and Sealed this

Twenty-third Day of September, 2008

A handwritten signature in black ink that reads "Jon W. Dudas". The signature is written in a cursive style with a large, stylized initial "J".

JON W. DUDAS

Director of the United States Patent and Trademark Office