



US00D573238S

(12) **United States Design Patent**
Patterson et al.

(10) **Patent No.:** **US D573,238 S**
(45) **Date of Patent:** **** Jul. 15, 2008**

(54) **RECESSED SHOWER STORAGE**

D561,307 S * 2/2008 Breymaier et al. D23/275

(75) Inventors: **Charles Patterson**, Durango, CO (US);
Victor Hoernig, Lowell, IN (US)

* cited by examiner

(73) Assignee: **American Shower & Bath Corporation**, Moorestown, NJ (US)

Primary Examiner—Robert A Delehanty
(74) *Attorney, Agent, or Firm*—Nirav D. Parikh; Lloyd D. Doigan

(**) Term: **14 Years**

(57) **CLAIM**

(21) Appl. No.: **29/298,415**

The ornamental design for a recessed shower storage, as shown and described.

(22) Filed: **Dec. 5, 2007**

DESCRIPTION

(51) **LOC (8) Cl.** **23-02**

FIG. 1 is a front perspective view of a recessed shower storage showing our new design;

(52) **U.S. Cl.** **D23/305**

FIG. 2 is a rear perspective view thereof;

(58) **Field of Classification Search** D23/275–277,
D23/304–305; 4/538, 663, 596, 612, 614
See application file for complete search history.

FIG. 3 is a front elevational thereof;

FIG. 4 is a top plan view thereof;

(56) **References Cited**

FIG. 5 is a right side elevational view thereof;

U.S. PATENT DOCUMENTS

FIG. 6 is a left side elevational view thereof; and,

D226,853 S * 5/1973 Korol D23/305
4,384,376 A * 5/1983 Shrode 4/607
4,541,131 A * 9/1985 Sussman 4/596

FIG. 7 is a rear elevational view thereof.

1 Claim, 3 Drawing Sheets

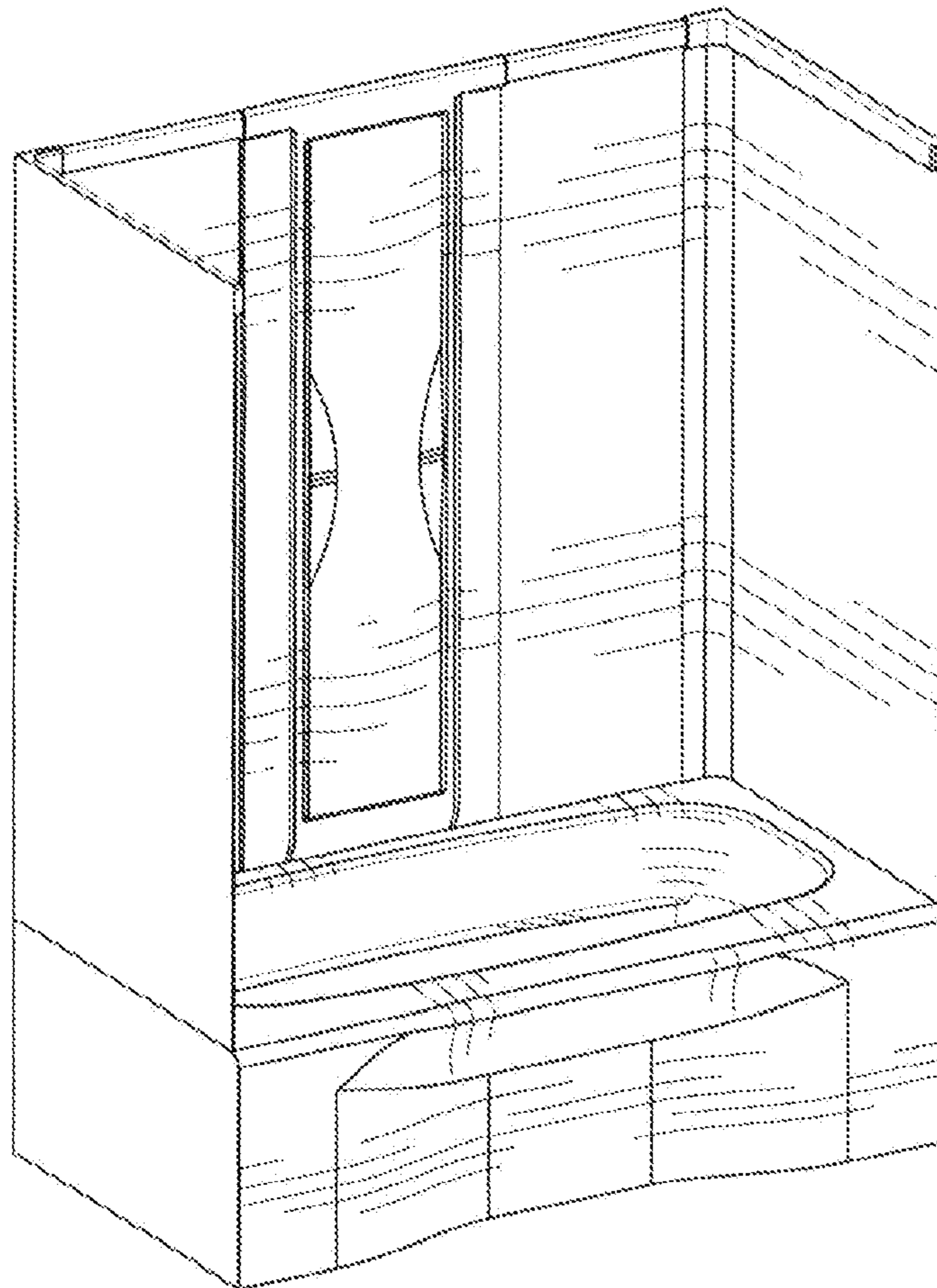

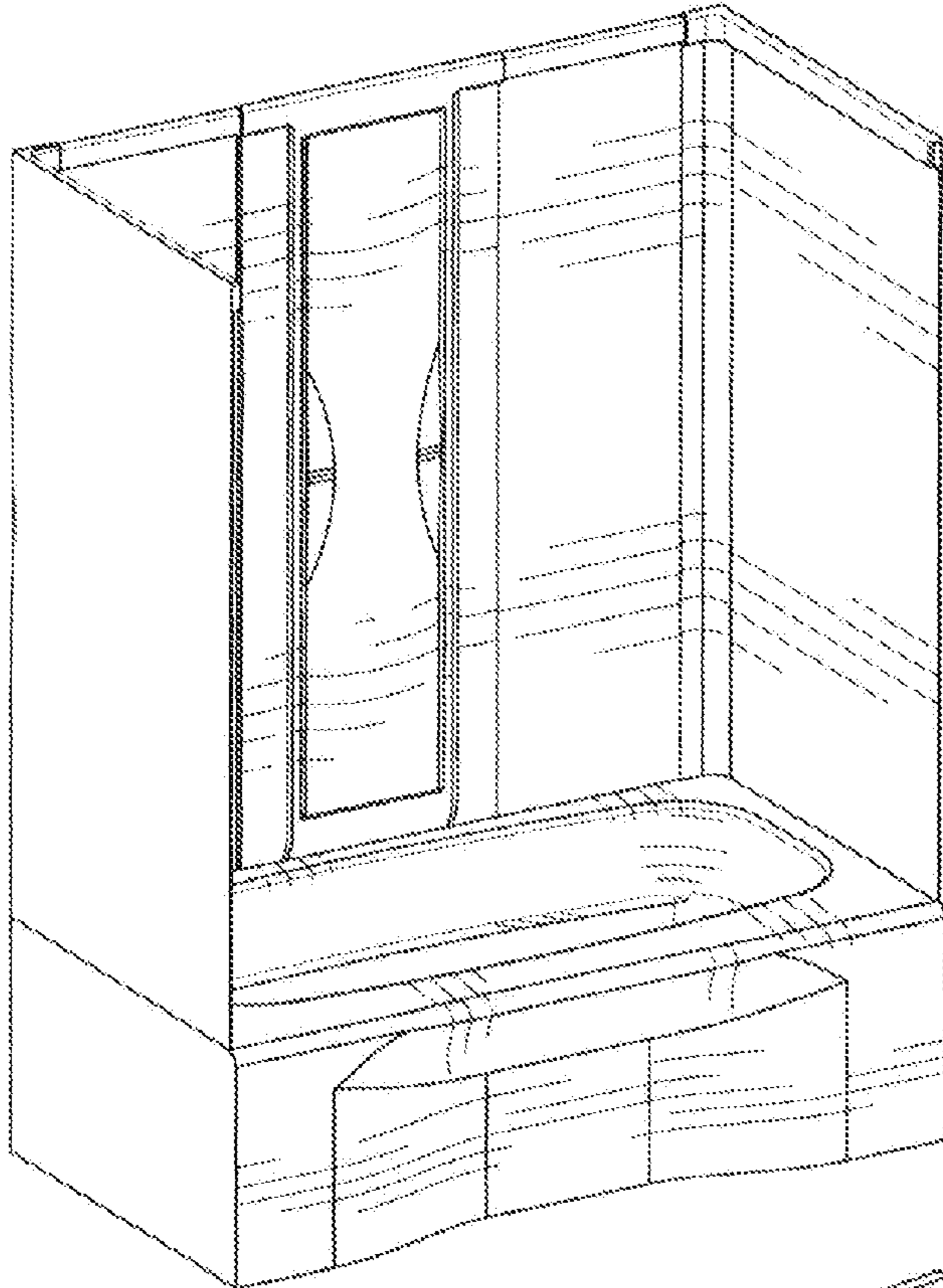

Fig-1

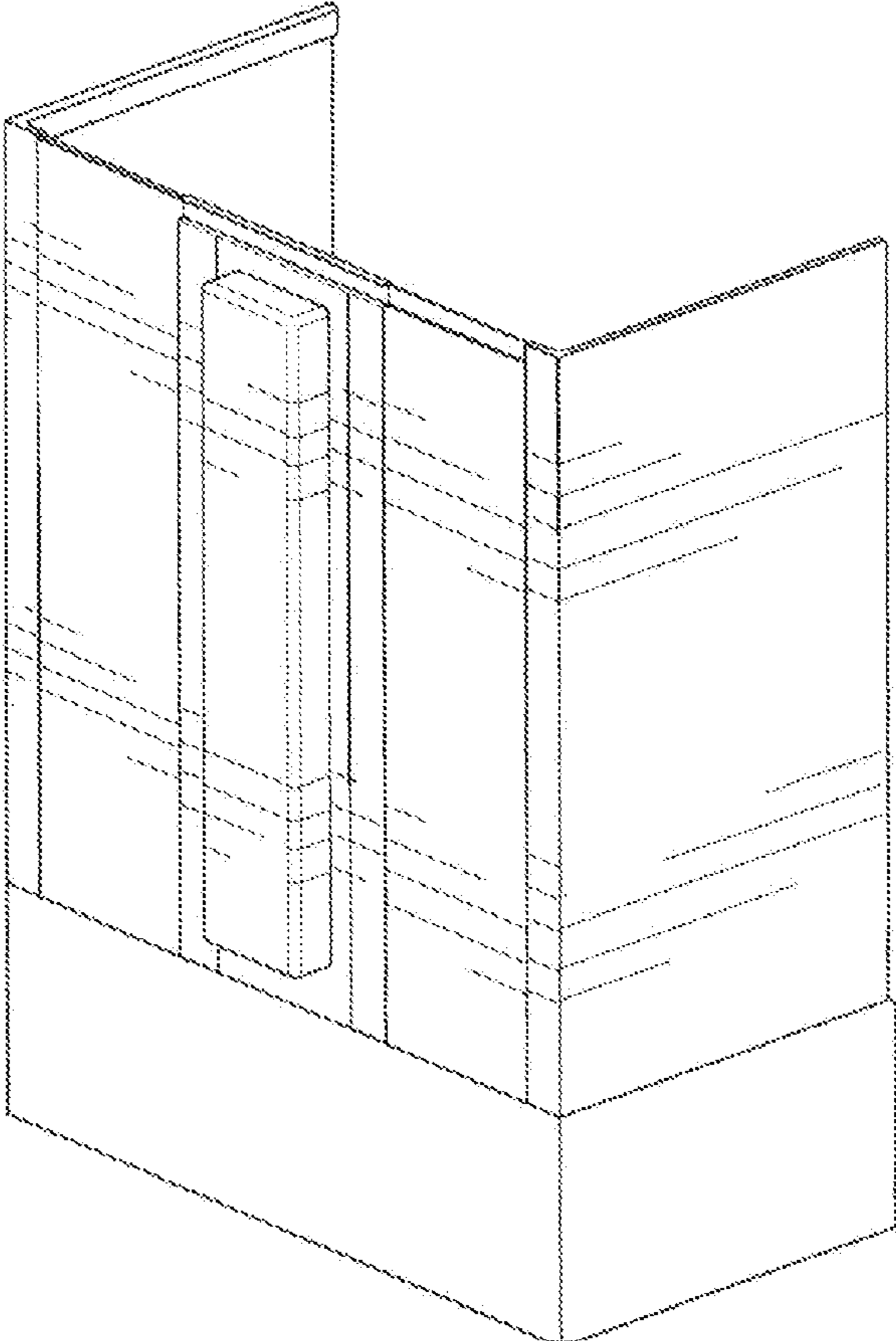

Fig-2

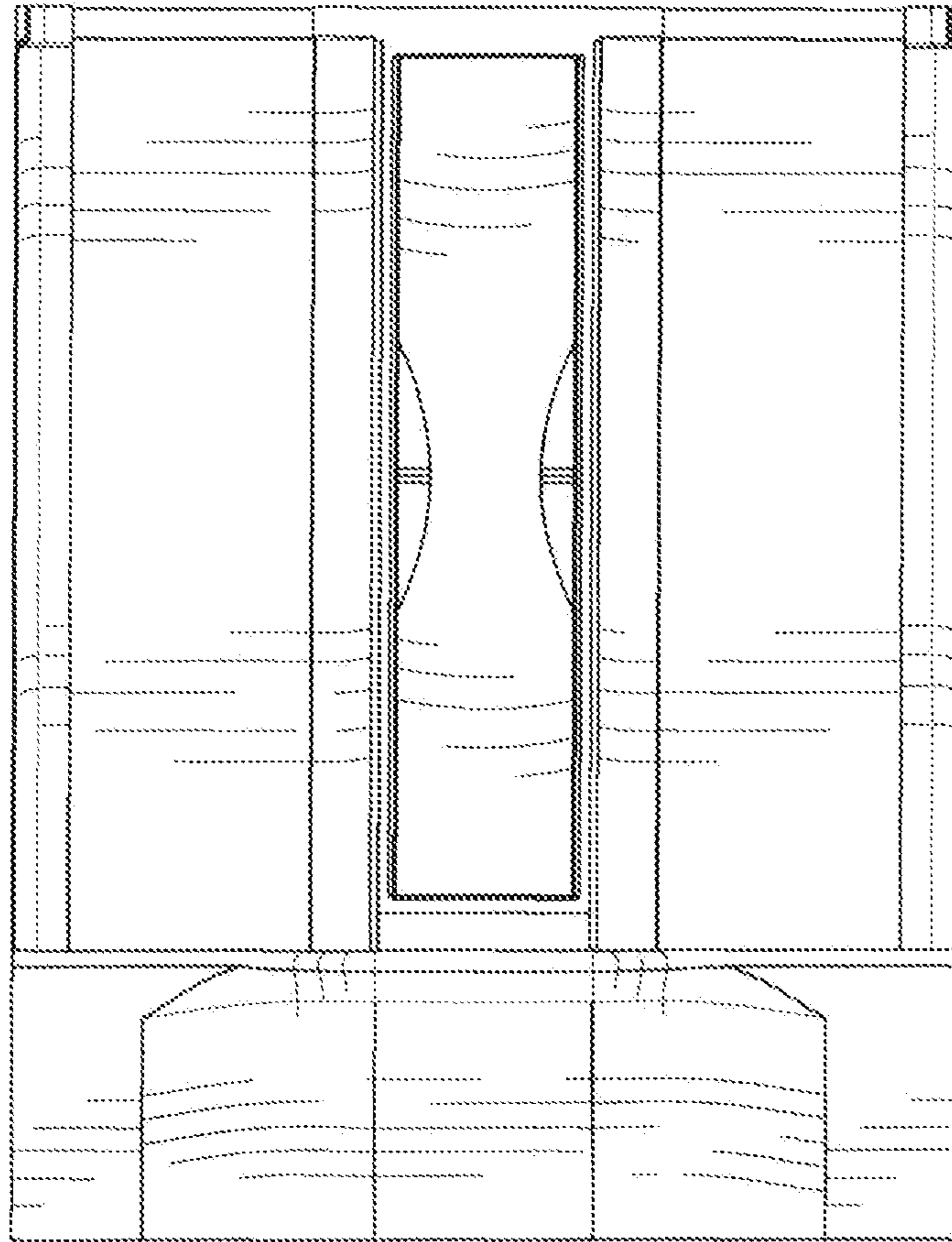

Fig-3

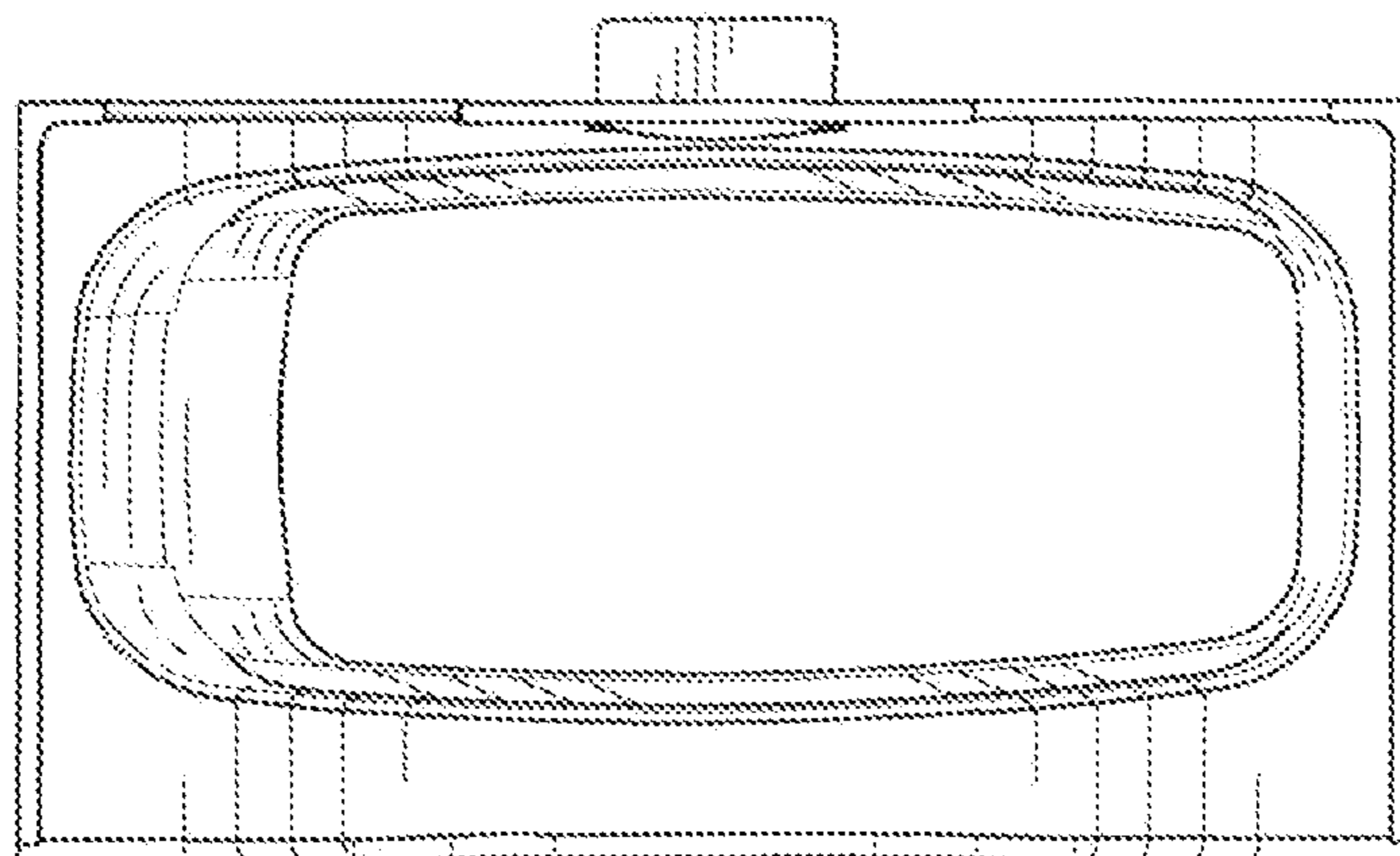

Fig-4

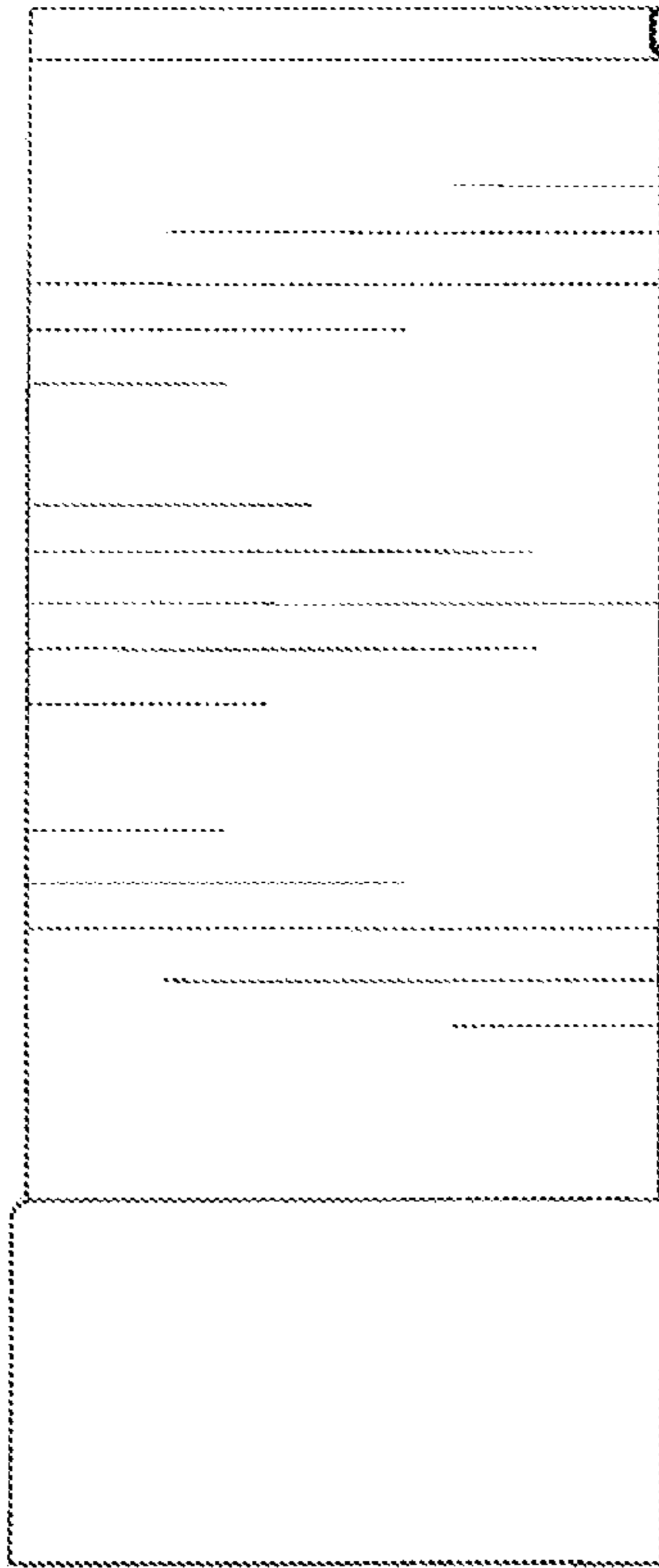

Fig-5

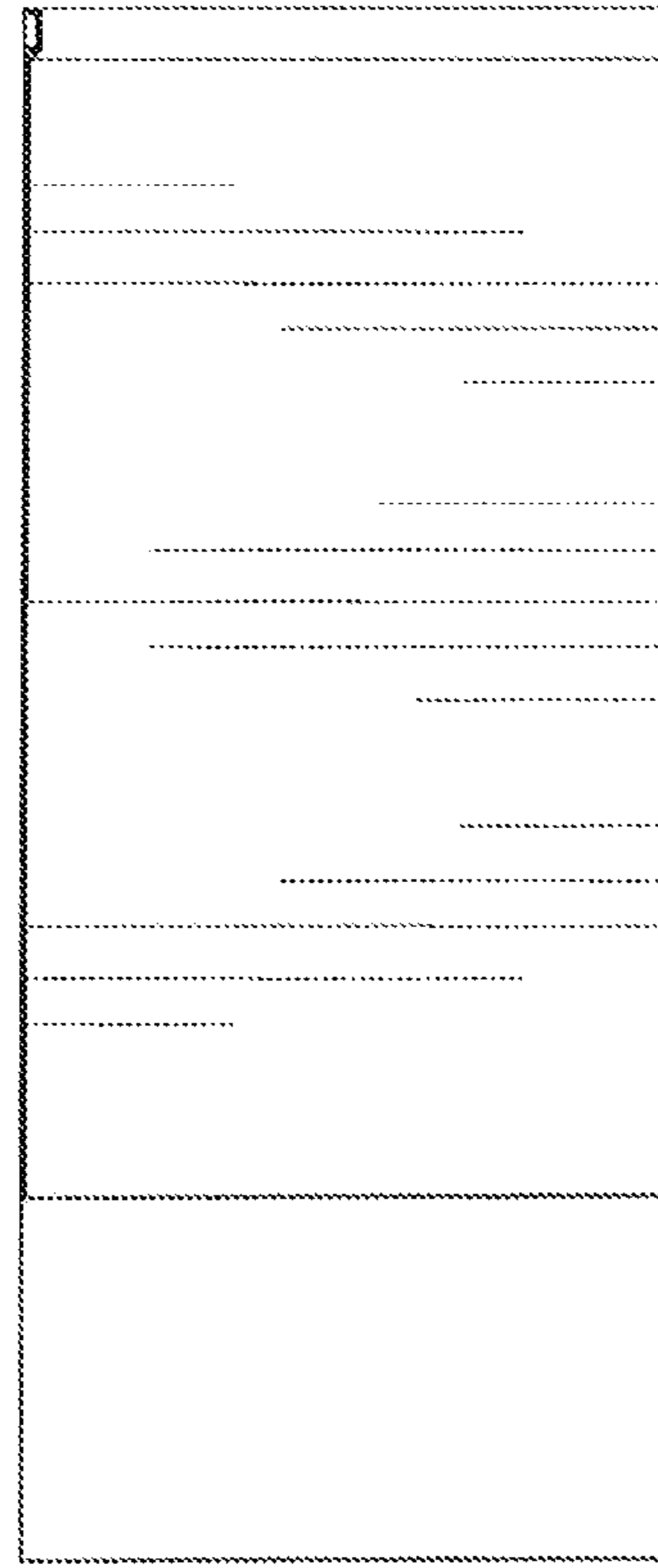

Fig-6

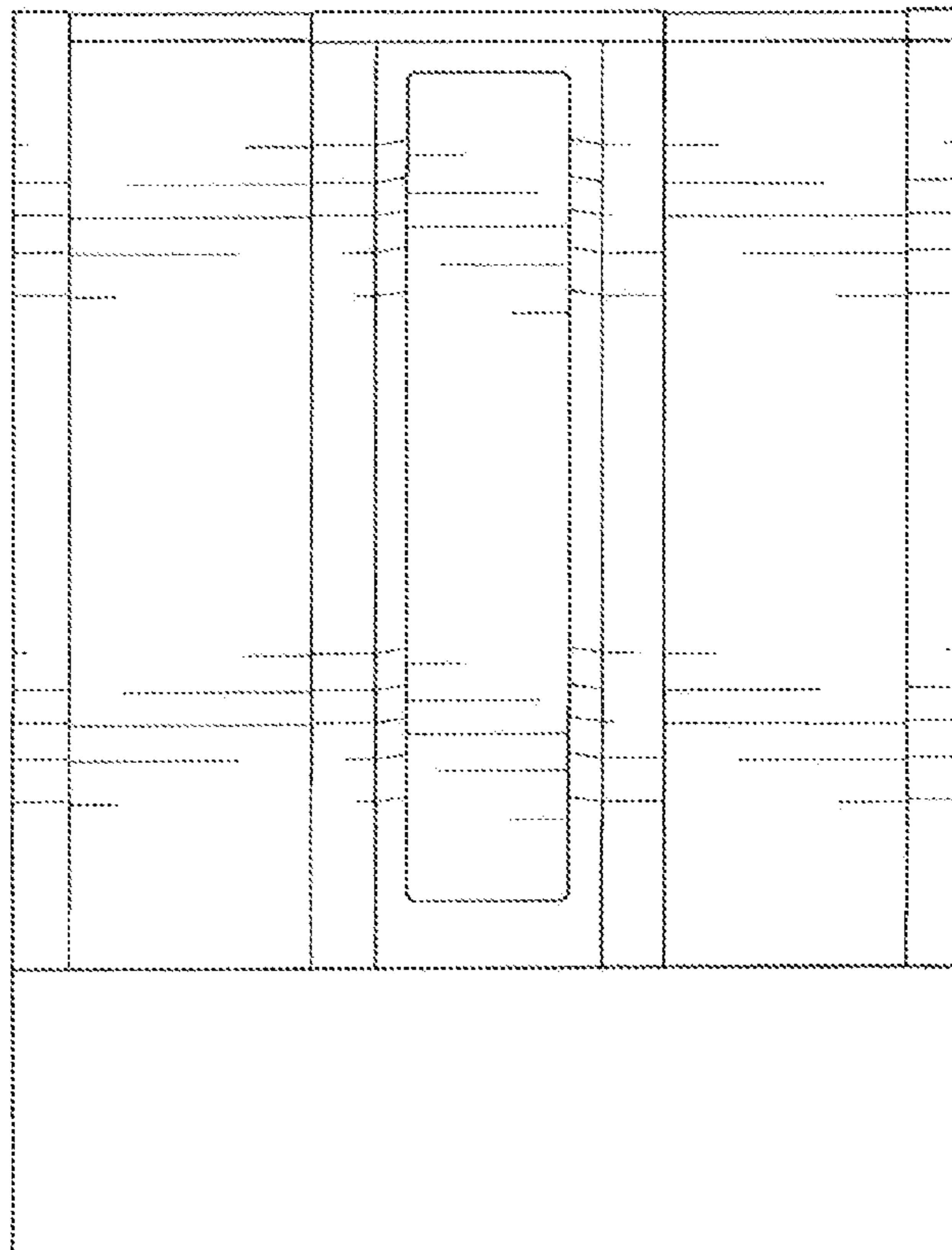

Fig-7