



US00D573105S

(12) **United States Design Patent**
Richey

(10) **Patent No.:** **US D573,105 S**
(45) **Date of Patent:** **** Jul. 15, 2008**

(54) **ELECTRICAL SWITCH MODULE COVER**

(76) Inventor: **Leonard Richey**, 440 W. 73rd St.,
Indianapolis, IN (US) 46206

(**) Term: **14 Years**

(21) Appl. No.: **29/256,348**

(22) Filed: **Mar. 17, 2006**

(51) **LOC (8) Cl.** **13-03**

(52) **U.S. Cl.** **D13/156**

(58) **Field of Classification Search** D13/156,
D13/152, 177; 174/50, 58, 66-67; 439/135-136,
439/148

See application file for complete search history.

(56) **References Cited**

U.S. PATENT DOCUMENTS

D345,142	S	*	3/1994	Porter	D13/156
D346,361	S		4/1994	Richey et al.	D13/156
6,103,974	A	*	8/2000	Erdfarb	174/66
6,166,329	A	*	12/2000	Oliver et al.	174/66
6,520,363	B1	*	2/2003	Sullivan	174/66
6,653,566	B2	*	11/2003	Petak et al.	174/66
D502,926	S	*	3/2005	Zimmerman	D13/156
D509,193	S	*	9/2005	Piedmont	D13/156
D528,513	S	*	9/2006	Grendahl	D13/177

* cited by examiner

Primary Examiner—Brian N Vinson

(74) *Attorney, Agent, or Firm*—Woodard, Emhardt, Moriarty,
McNett & Henry LLP

(57) **CLAIM**

The ornamental design for an electrical switch module cover,
as shown and described.

DESCRIPTION

FIG. 1 is a perspective view of a first embodiment of an
electrical switch module cover showing my new design;

FIG. 2 is a top plan view thereof;

FIG. 3 is a bottom plan view thereof;

FIG. 4 is a side elevational view thereof;

FIG. 5 is an end elevational view thereof;

FIG. 6 is a perspective view of a second embodiment thereof;

FIG. 7 is a top plan view thereof;

FIG. 8 is a bottom plan view thereof;

FIG. 9 is a side elevational view thereof;

FIG. 10 is an end elevational view thereof;

FIG. 11 is a perspective view of a third embodiment thereof;

FIG. 12 is a top plan view thereof;

FIG. 13 is a bottom plan view thereof;

FIG. 14 is a side elevational view thereof;

FIG. 15 is an end elevational view thereof;

FIG. 16 is a perspective view of a fourth embodiment thereof;

FIG. 17 is a top plan view thereof;

FIG. 18 is a bottom plan view thereof;

FIG. 19 is a side elevational view thereof;

FIG. 20 is an end elevational view thereof;

FIG. 21 is a perspective view of a fifth embodiment thereof;

FIG. 22 is a top plan view thereof;

FIG. 23 is a bottom plan view thereof;

FIG. 24 is a side elevational view thereof;

FIG. 25 is an end elevational view thereof;

FIG. 26 is a perspective view of a sixth embodiment thereof;

FIG. 27 is a top plan view thereof;

FIG. 28 is a bottom plan view thereof;

FIG. 29 is a side elevational view thereof;

FIG. 30 is an end elevational view thereof;

FIG. 31 is a perspective view of a seventh embodiment
thereof;

FIG. 32 is a top plan view thereof;

FIG. 33 is a bottom plan view thereof;

FIG. 34 is a side elevational view thereof;

FIG. 35 is an end elevational view thereof;

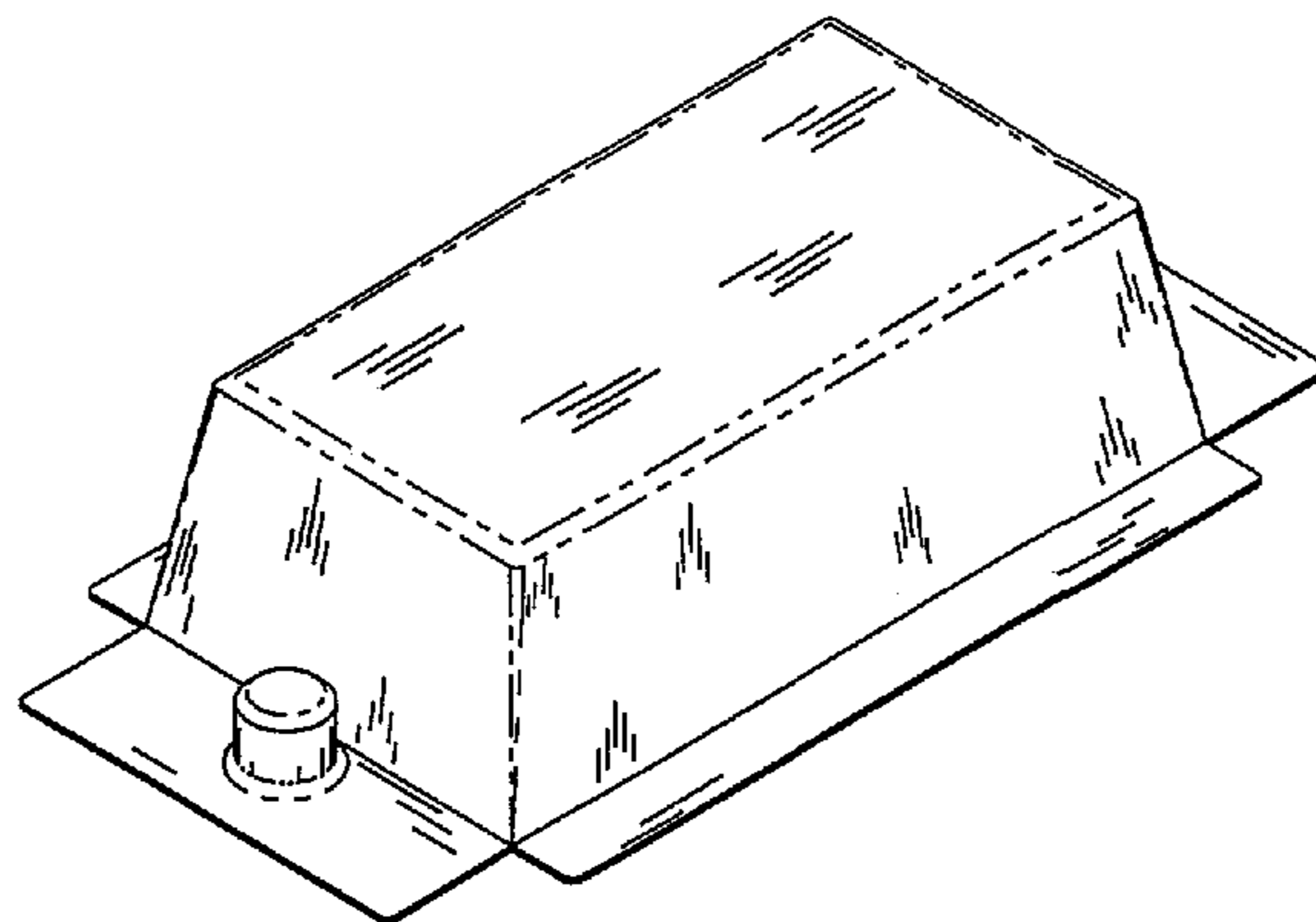

FIG. **36** is a perspective view of an eighth embodiment thereof, the only difference from that of the first embodiment is that of transparency;

FIG. **37** is a perspective view of a ninth embodiment thereof, the only difference from that of the second is that of transparency;

FIG. **38** is a perspective view of a tenth embodiment thereof, the only difference from that of the third embodiment is that of transparency;

FIG. **39** is a perspective view of an eleventh embodiment thereof, the only difference from that of the fourth embodiment is that of transparency;

FIG. **40** is a perspective view of a twelfth embodiment thereof, the only difference from that of the fifth embodiment is that of transparency;

FIG. **41** is a perspective view of a thirteenth embodiment thereof, the only difference from that of the sixth embodiment is that of transparency; and,

FIG. **42** is a perspective view of a fourteenth embodiment thereof, the only difference from that of the seventh embodiment is that of transparency.

1 Claim, 22 Drawing Sheets

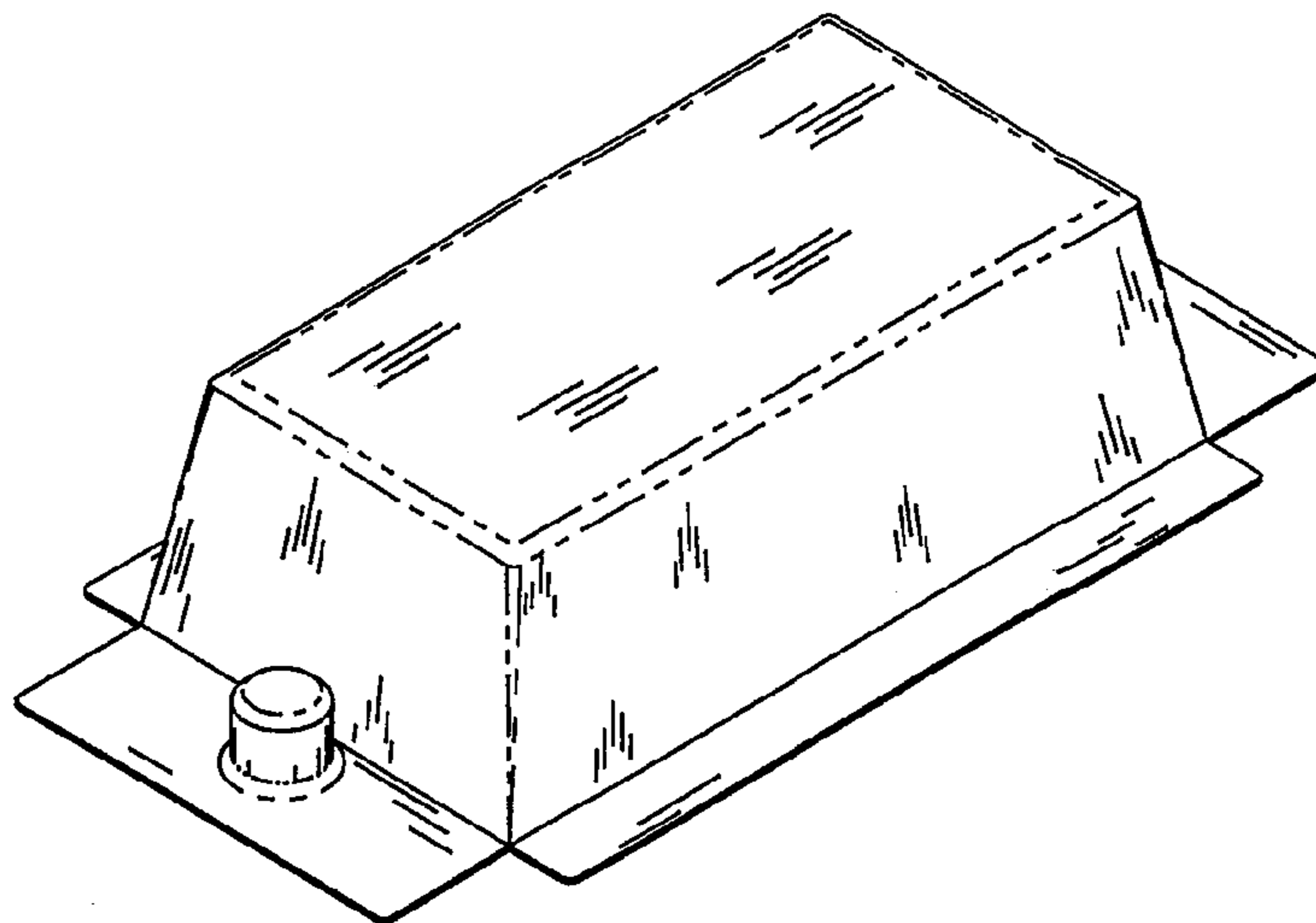

Fig. 1

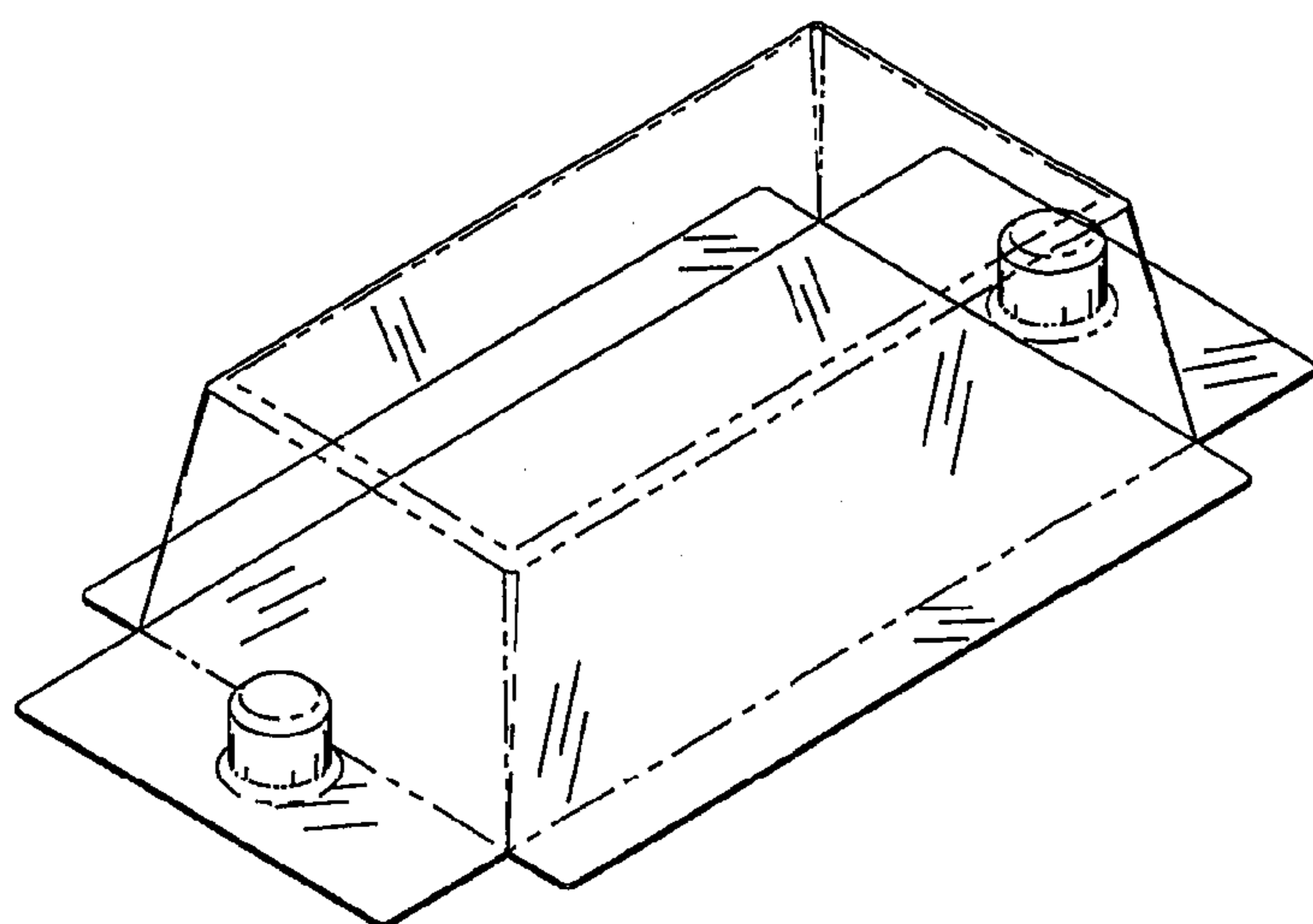

Fig. 36

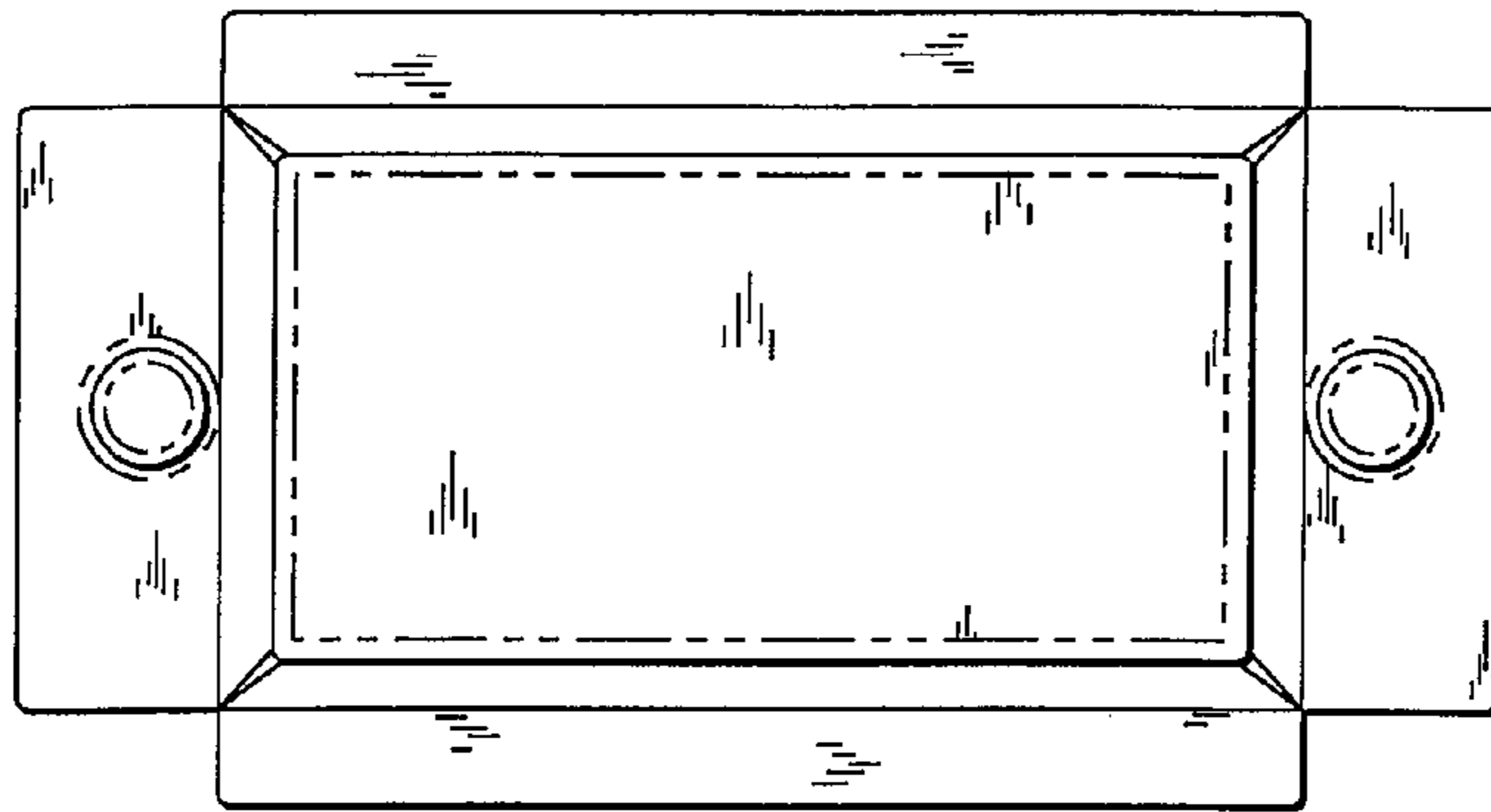

Fig. 2

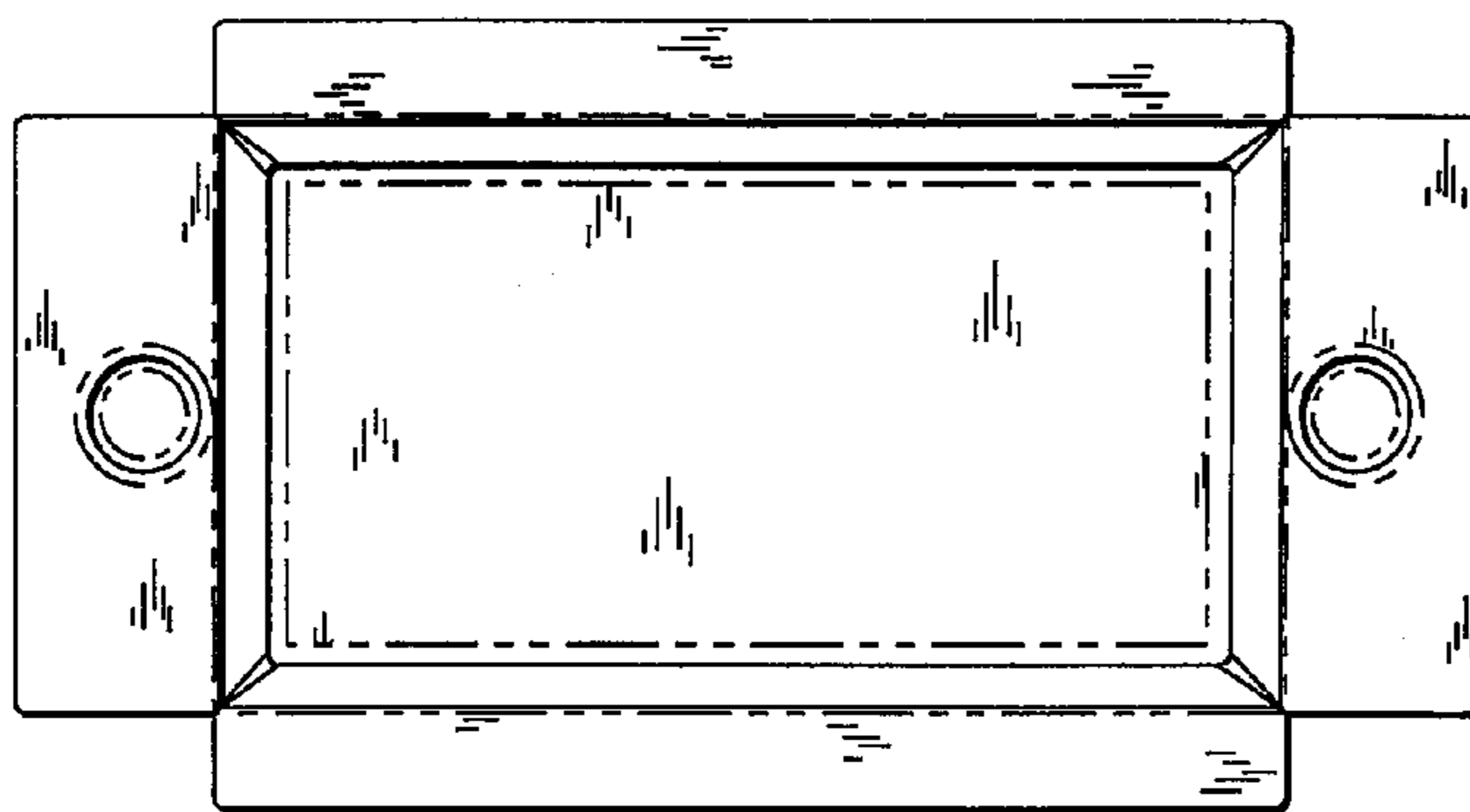

Fig. 3

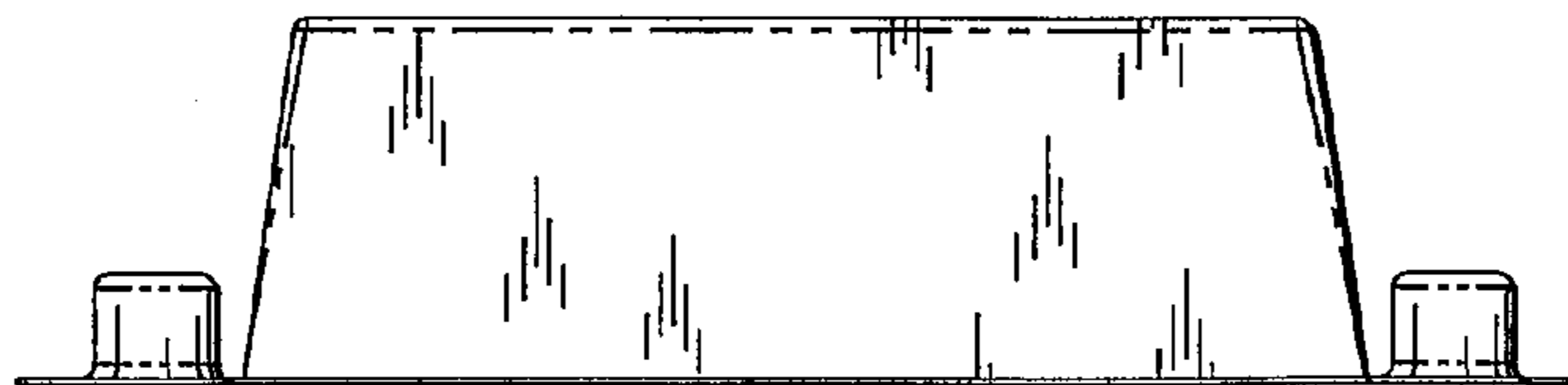

Fig. 4

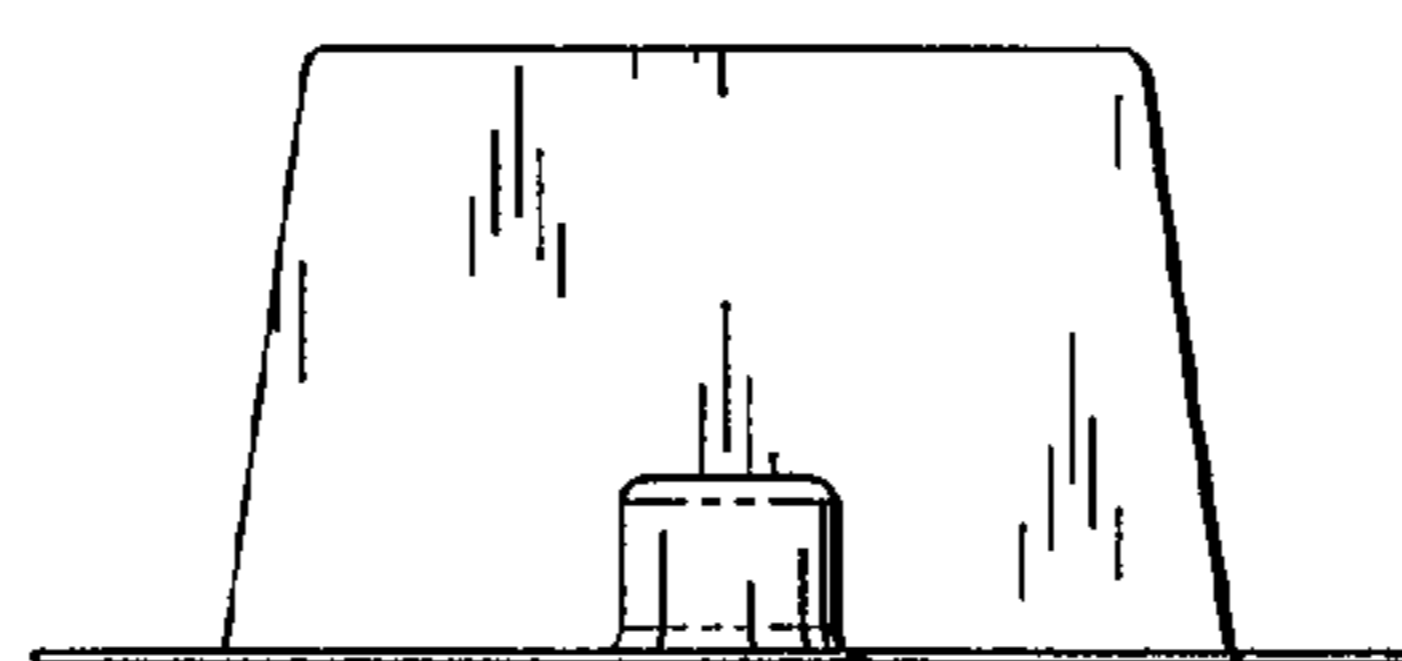

Fig. 5

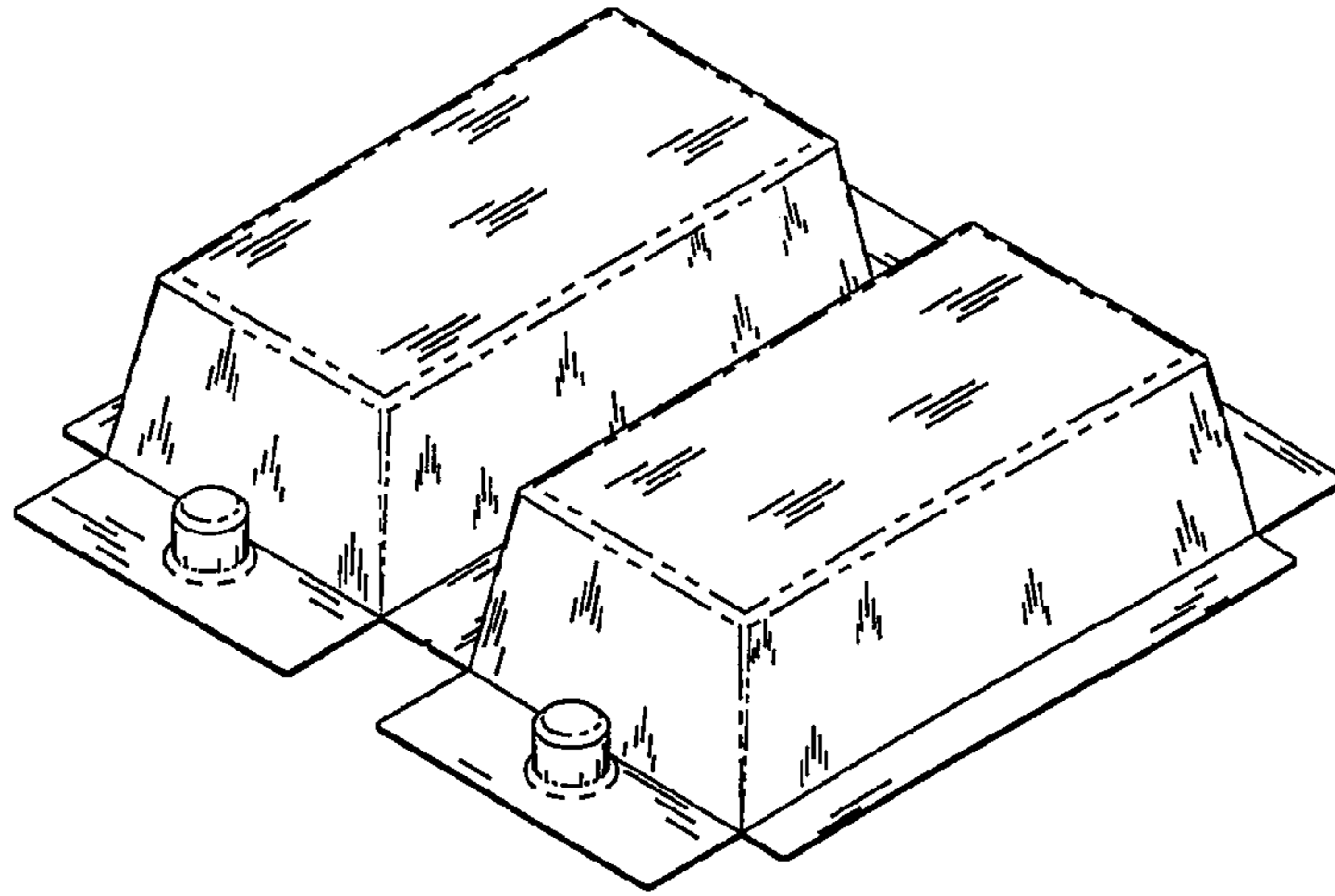

Fig. 6

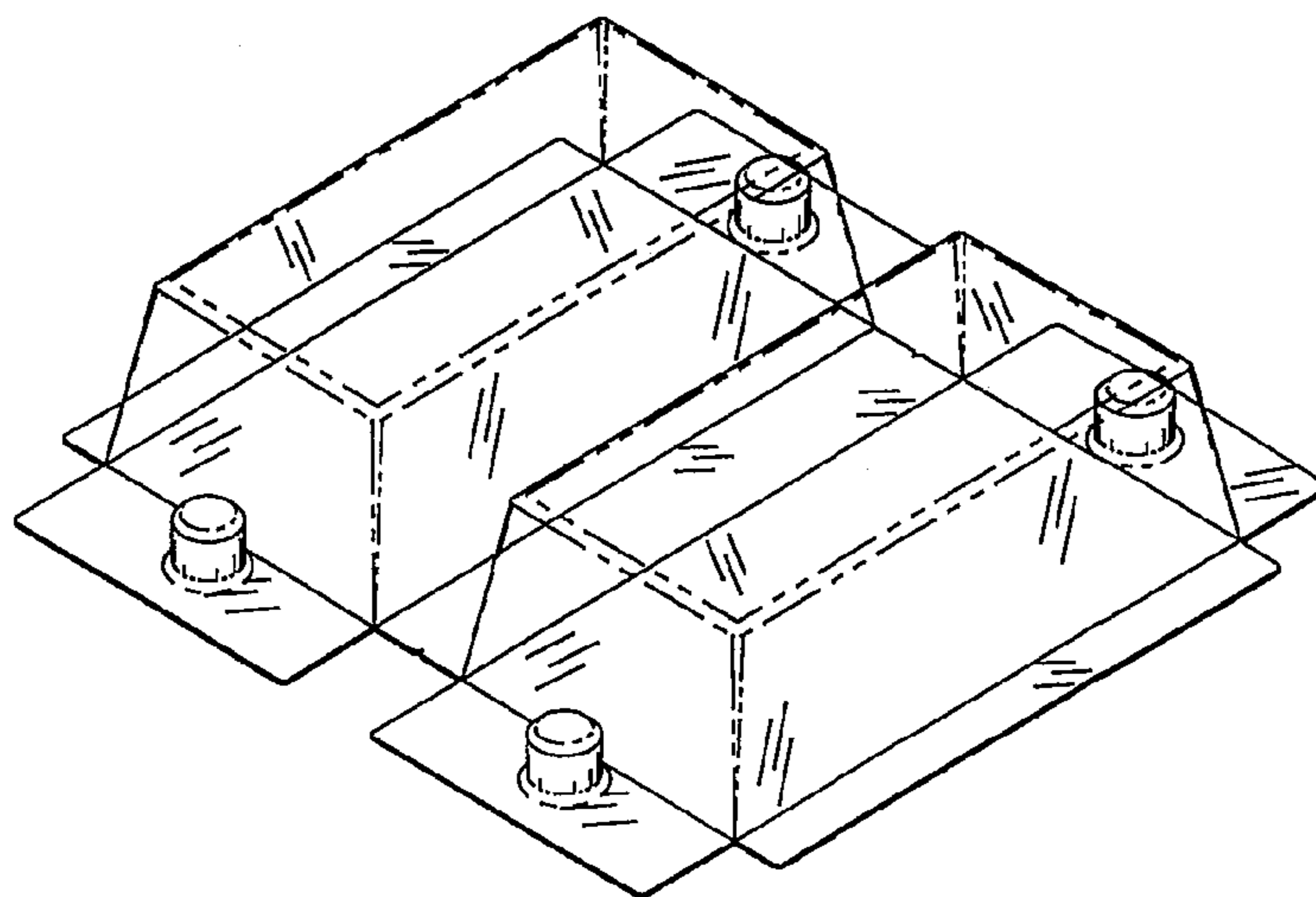

Fig. 37

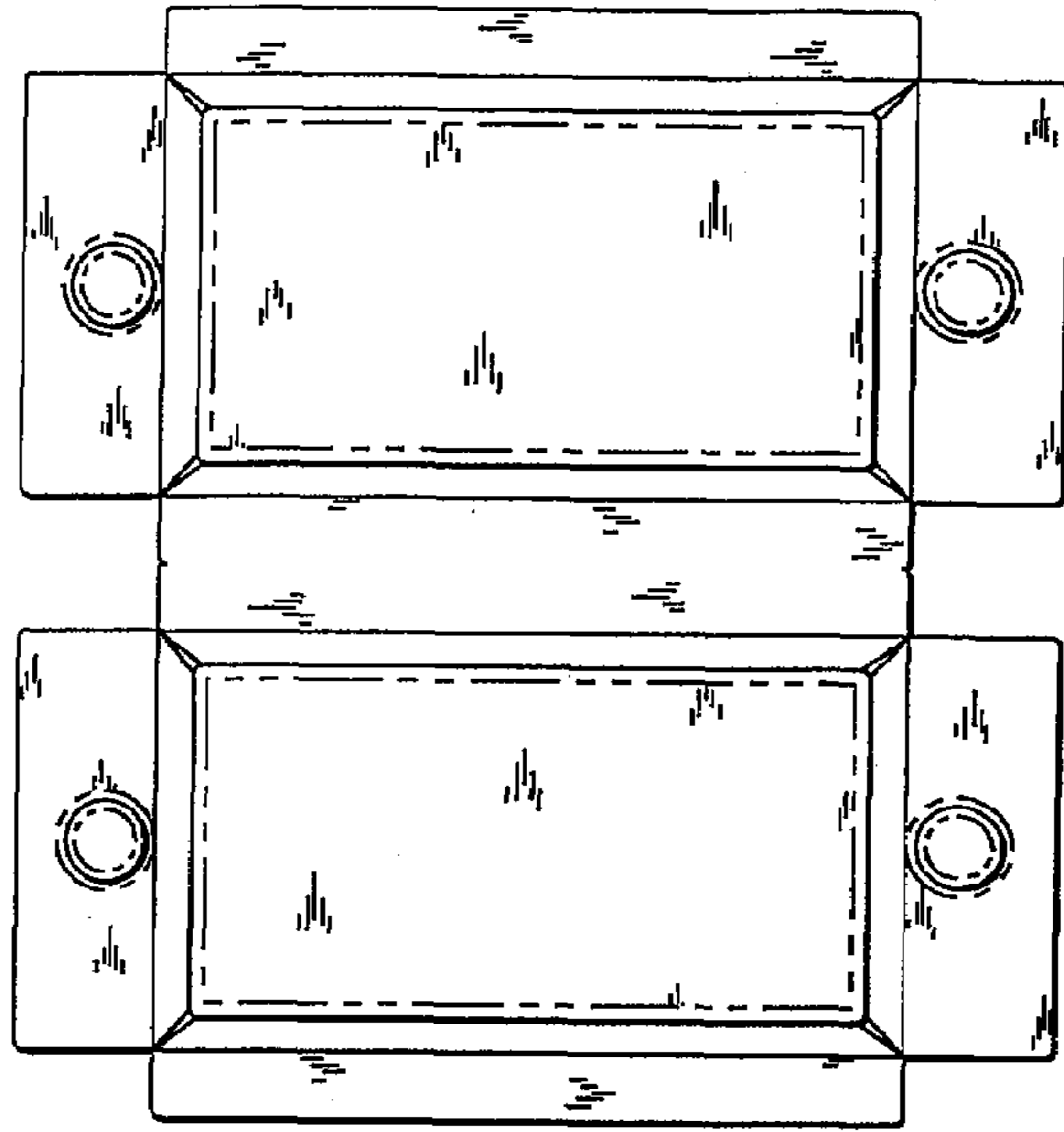

Fig. 7

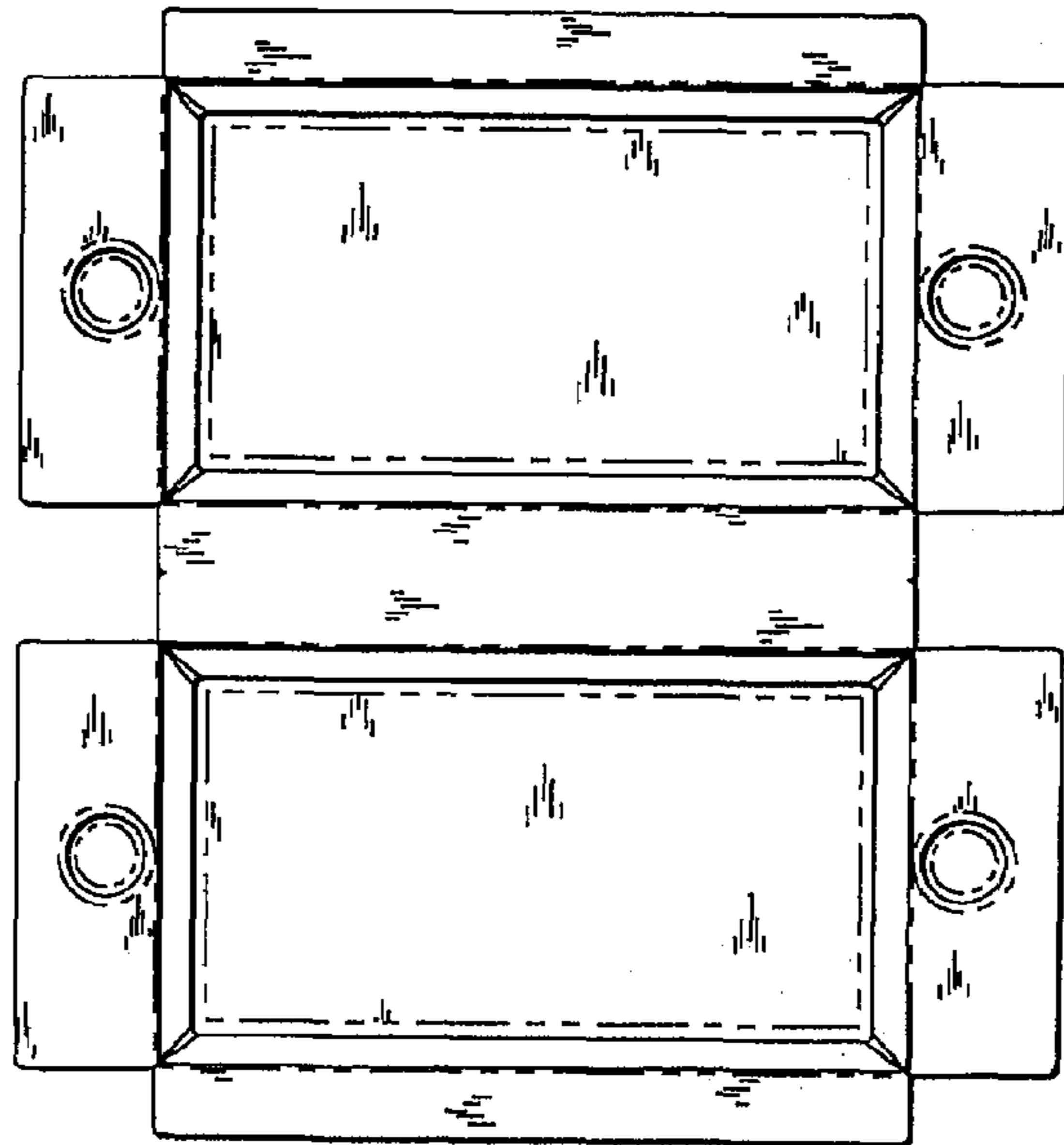

Fig. 8

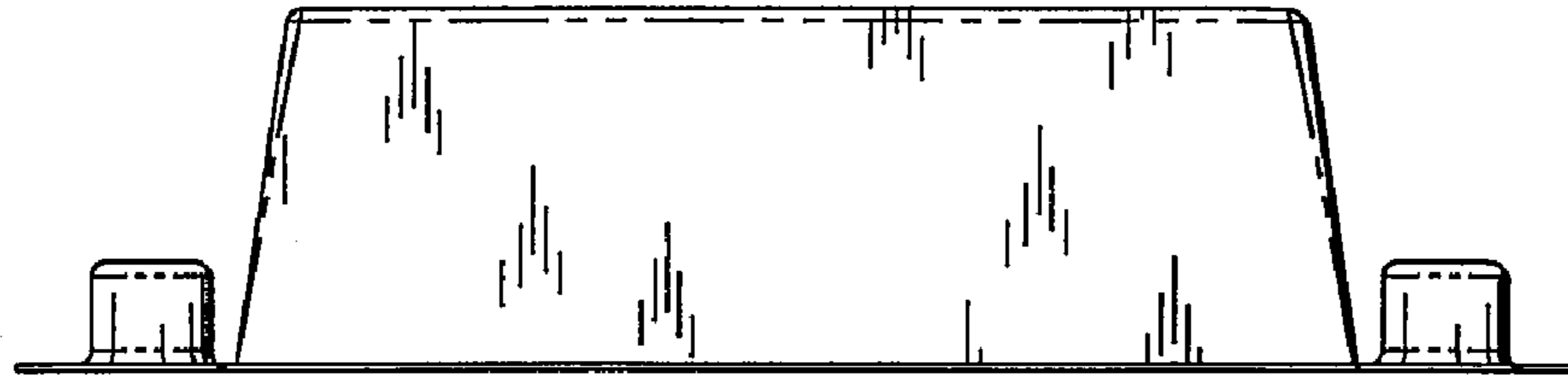

Fig. 9

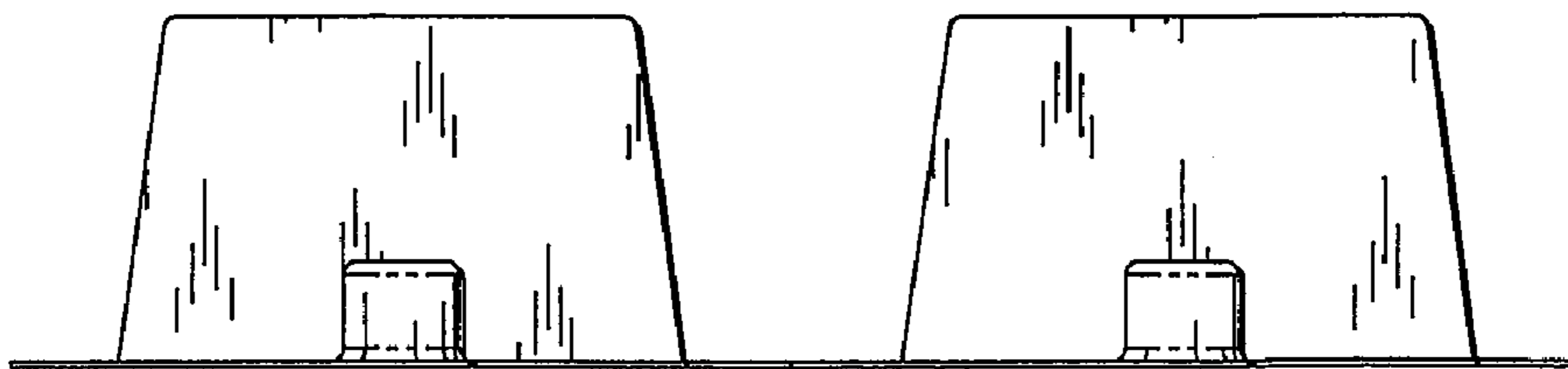

Fig. 10

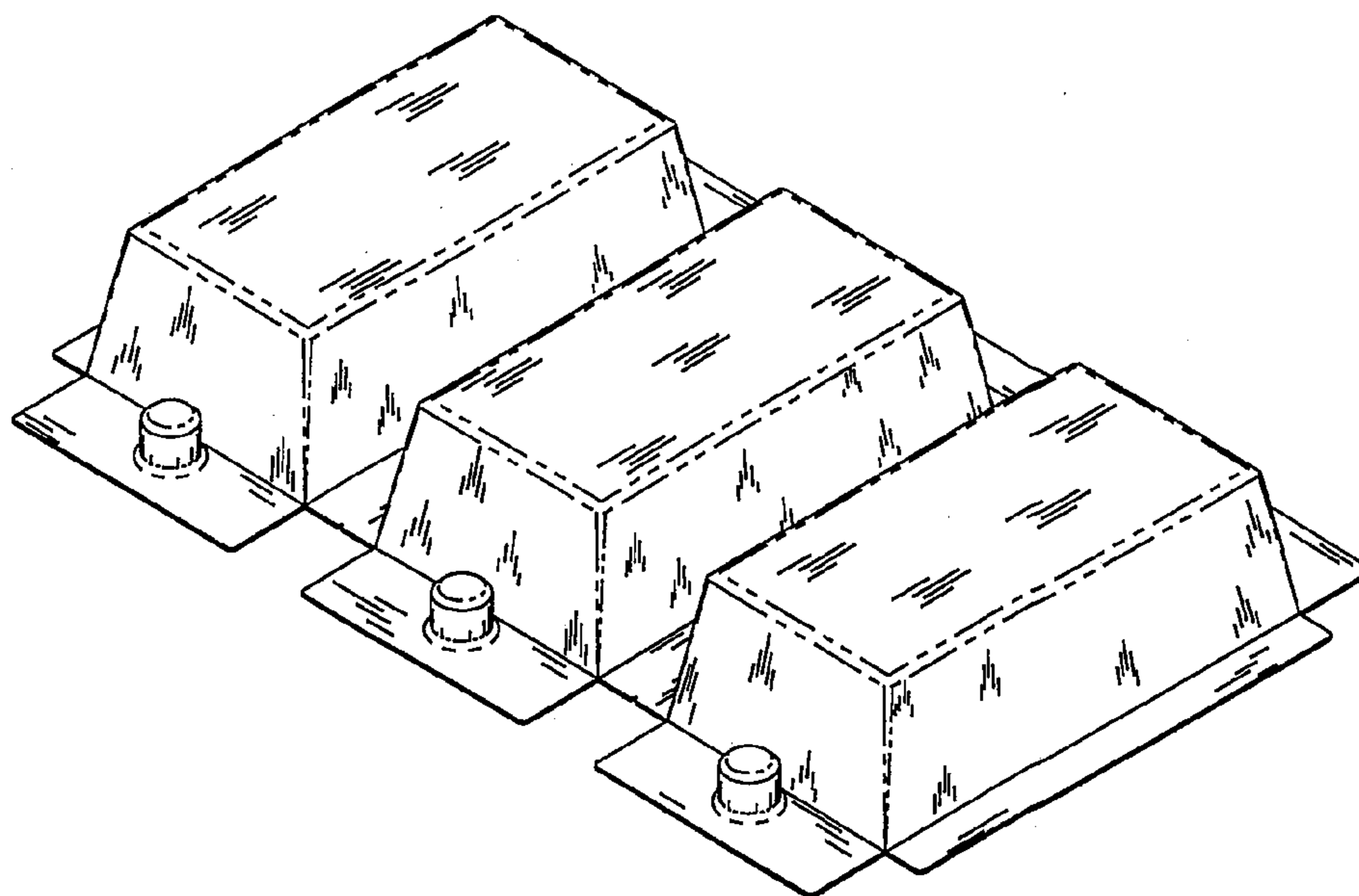

Fig. 11

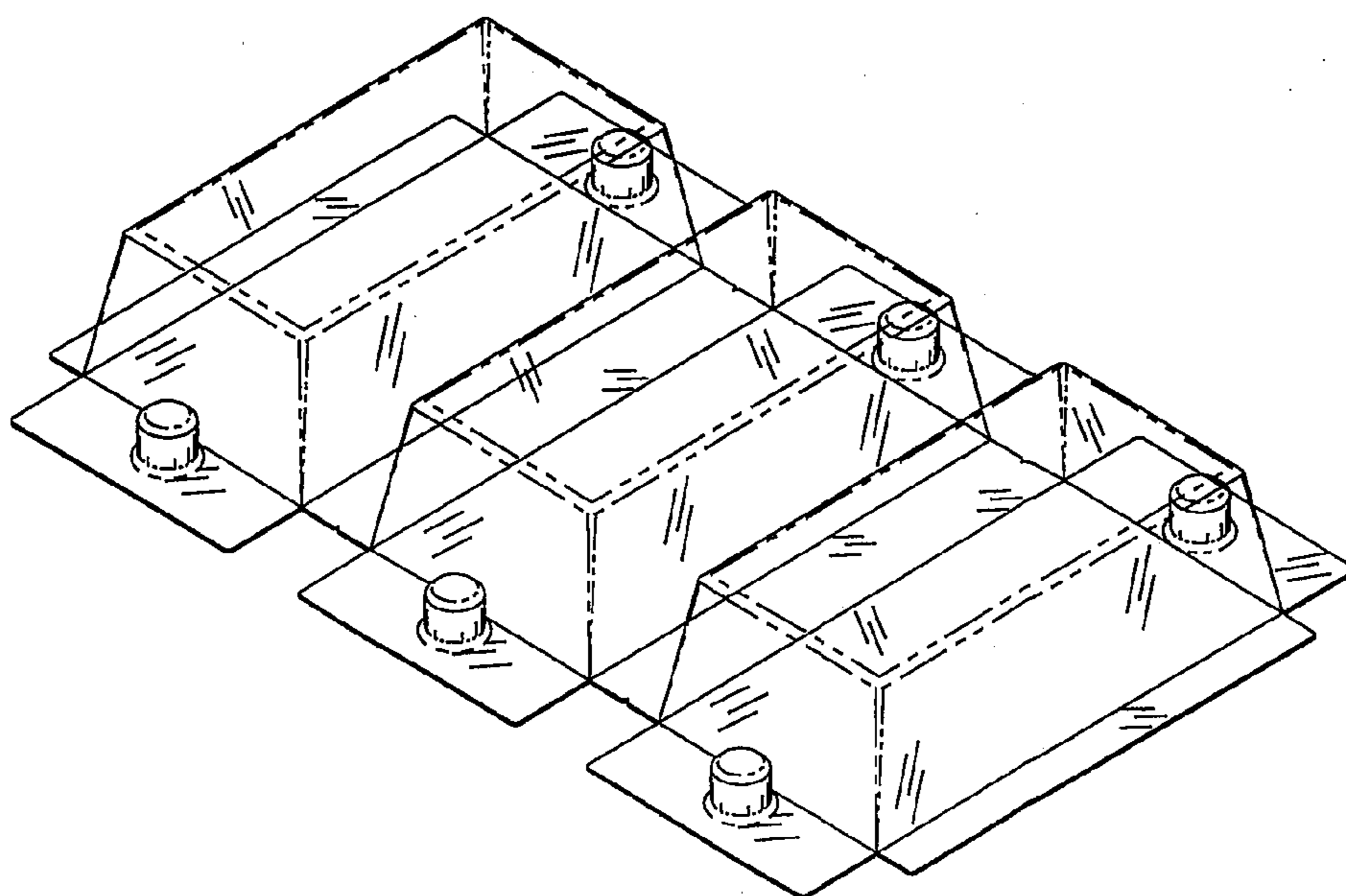

Fig. 38

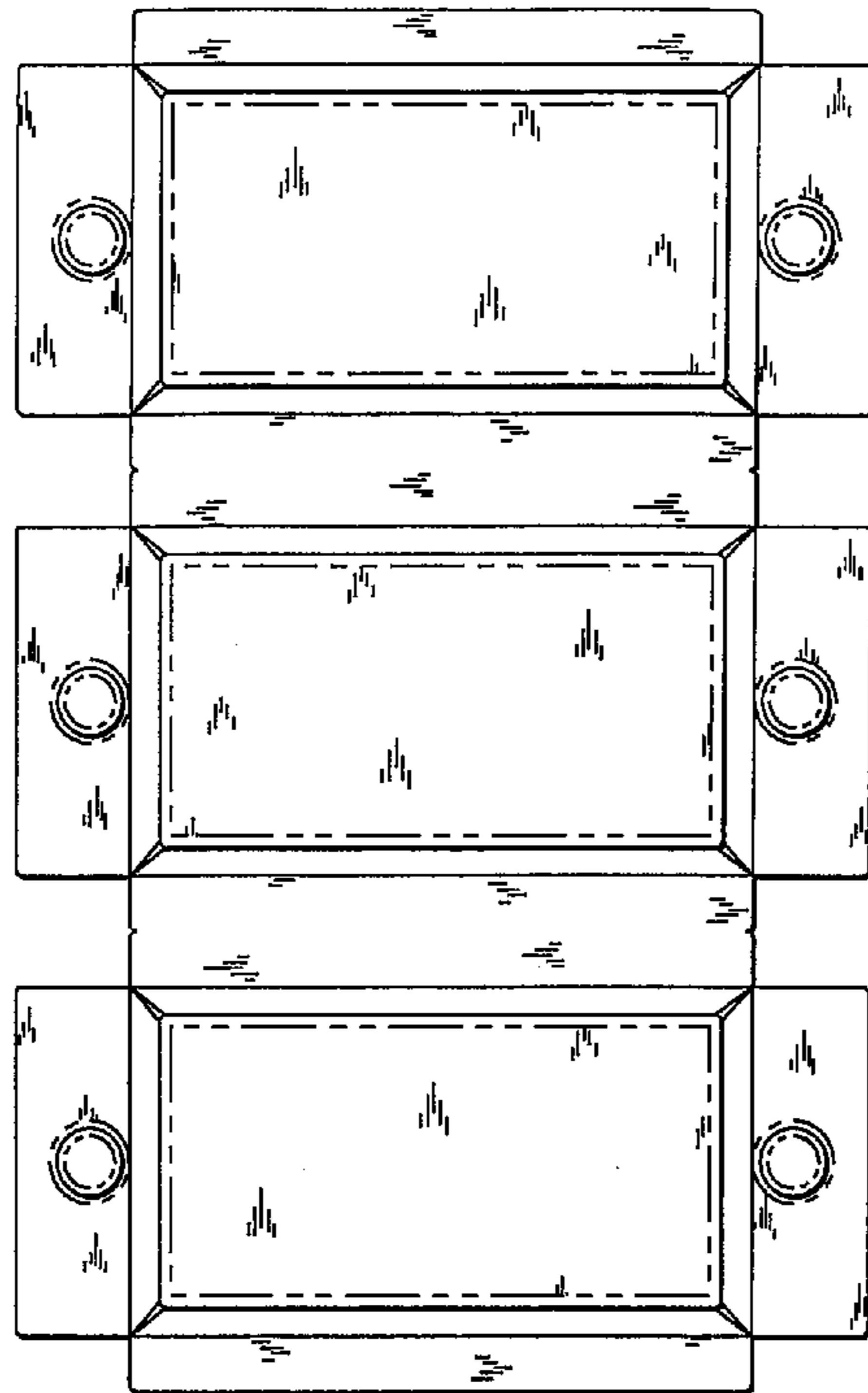

Fig. 12

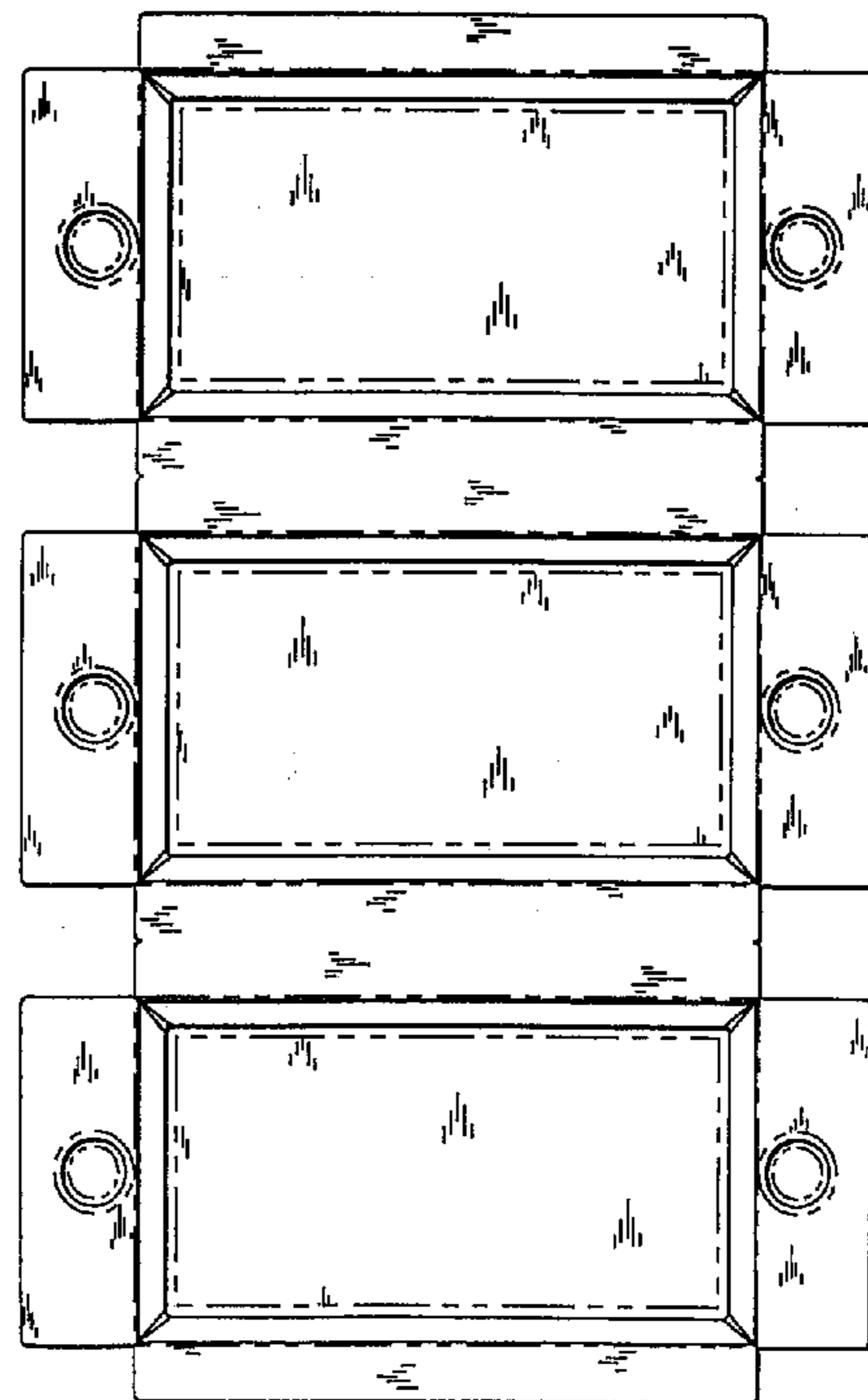

Fig. 13

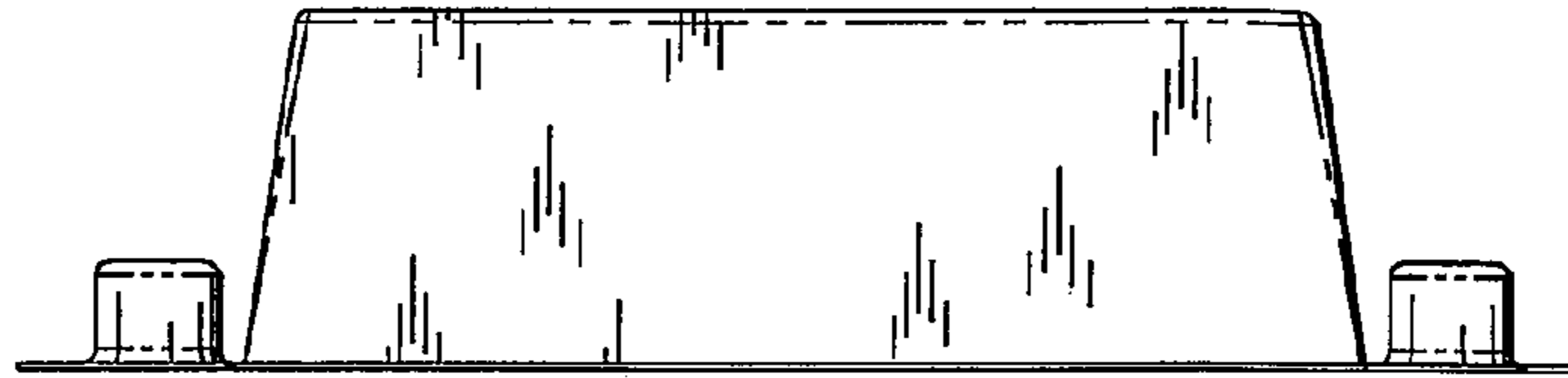

Fig. 14



Fig. 15

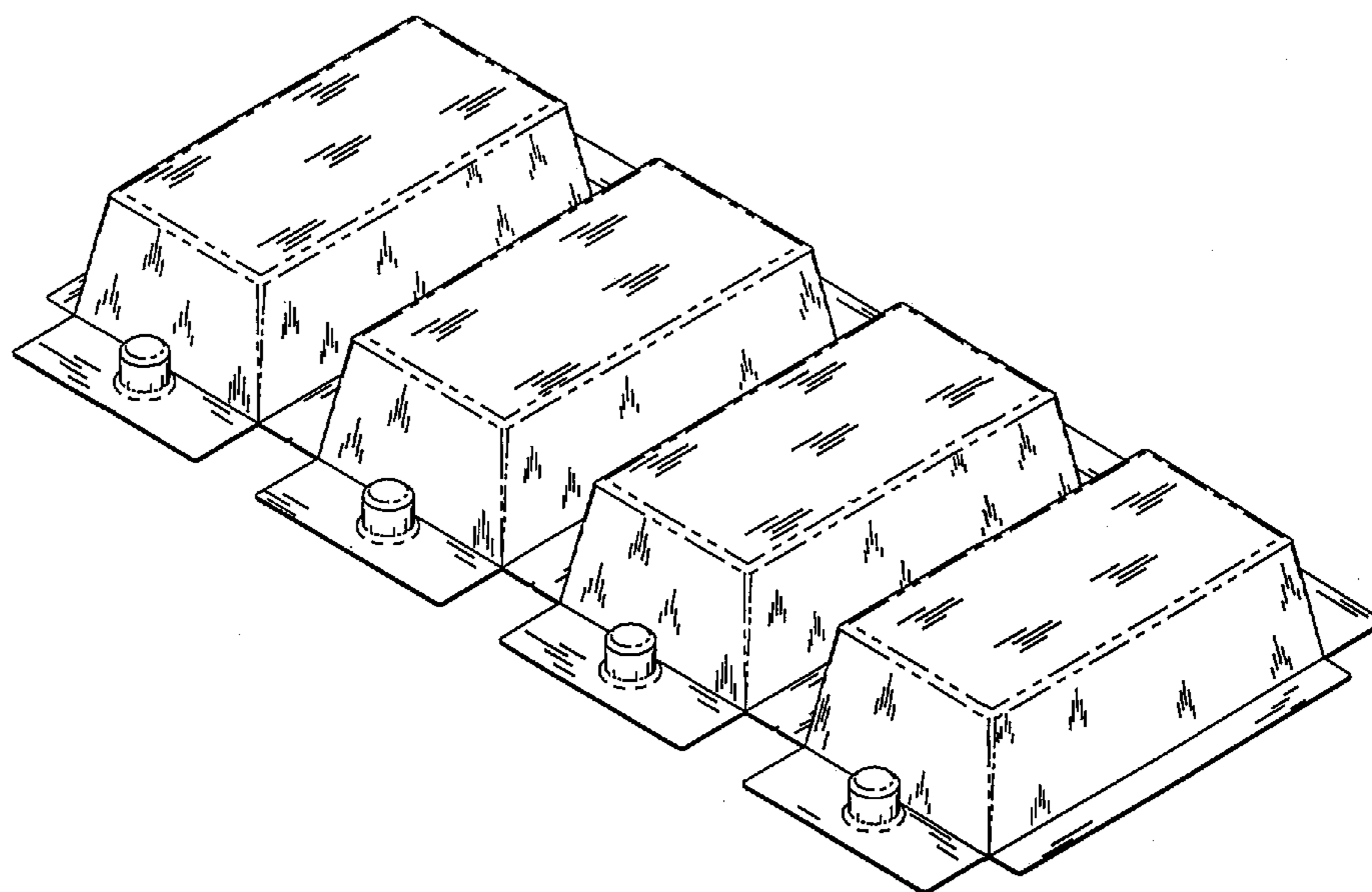

Fig. 16

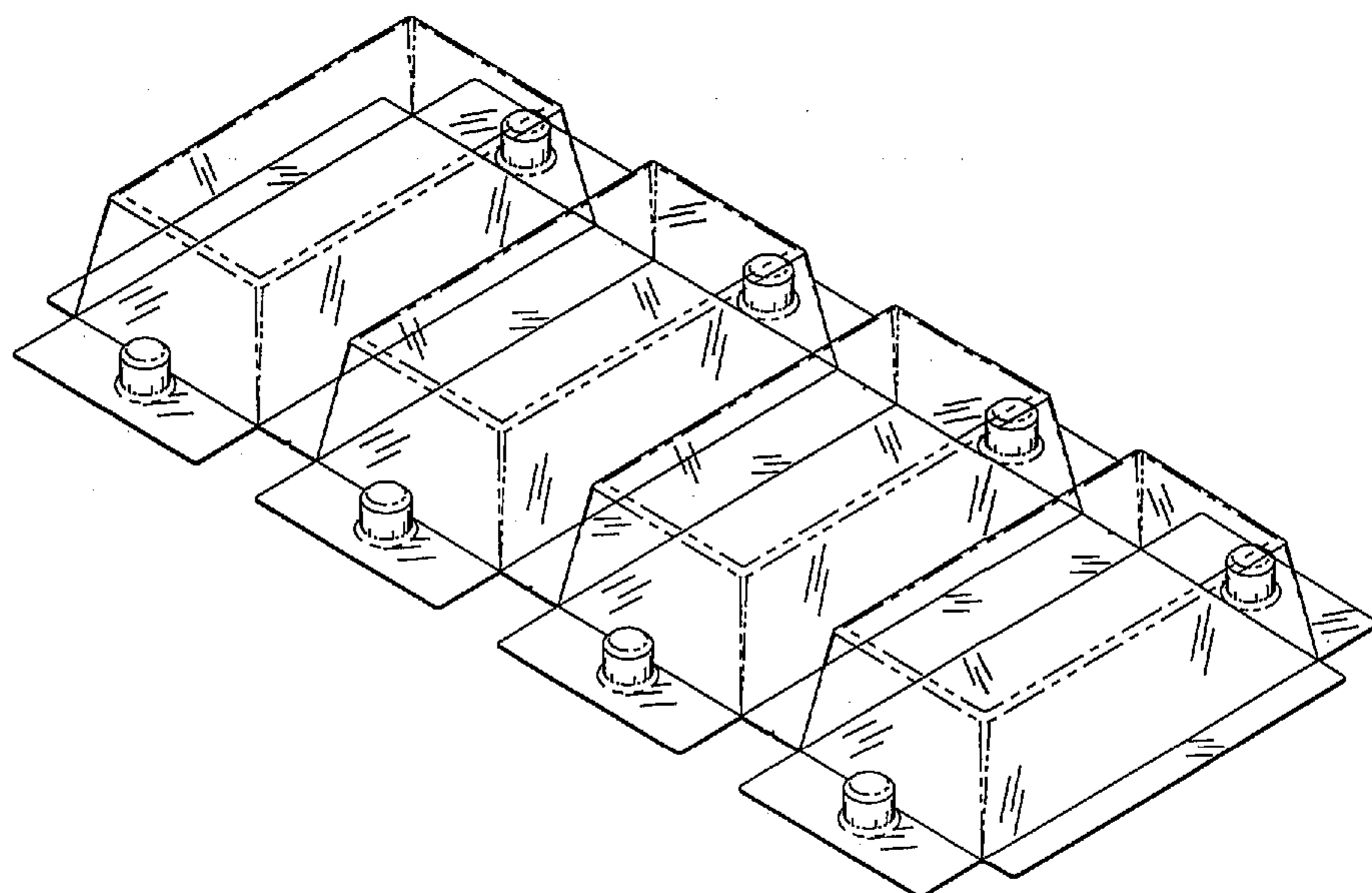

Fig. 39

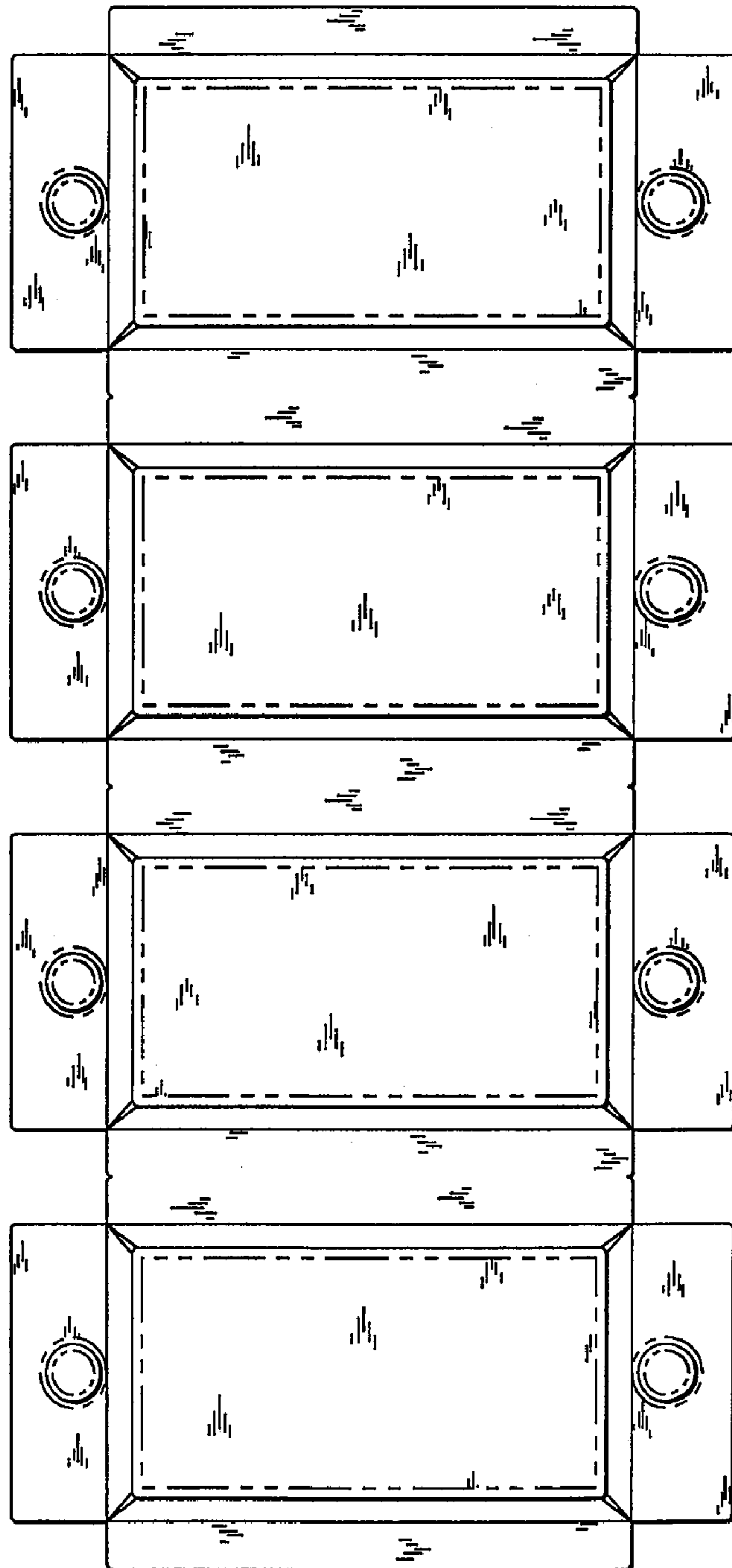

Fig. 17

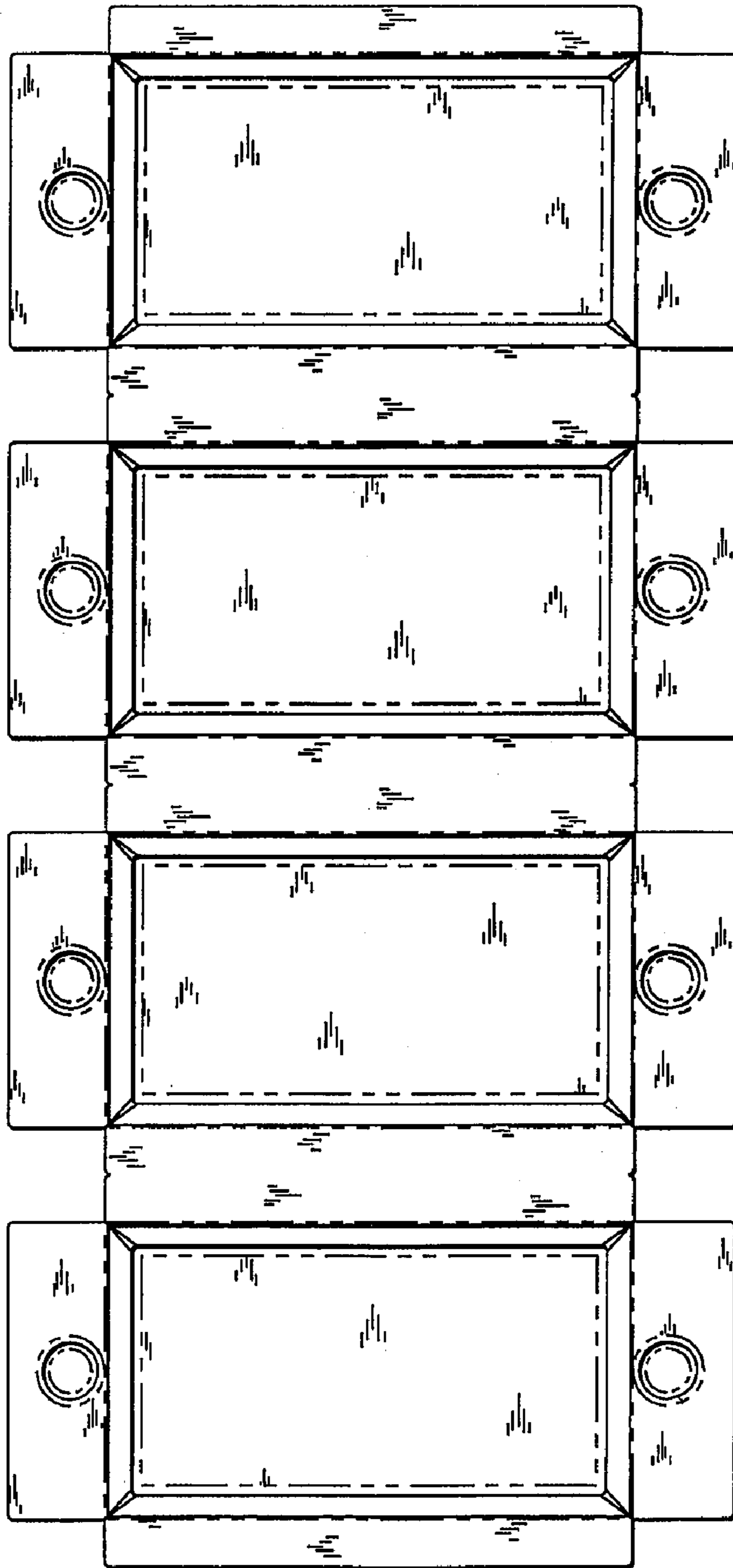

Fig. 18

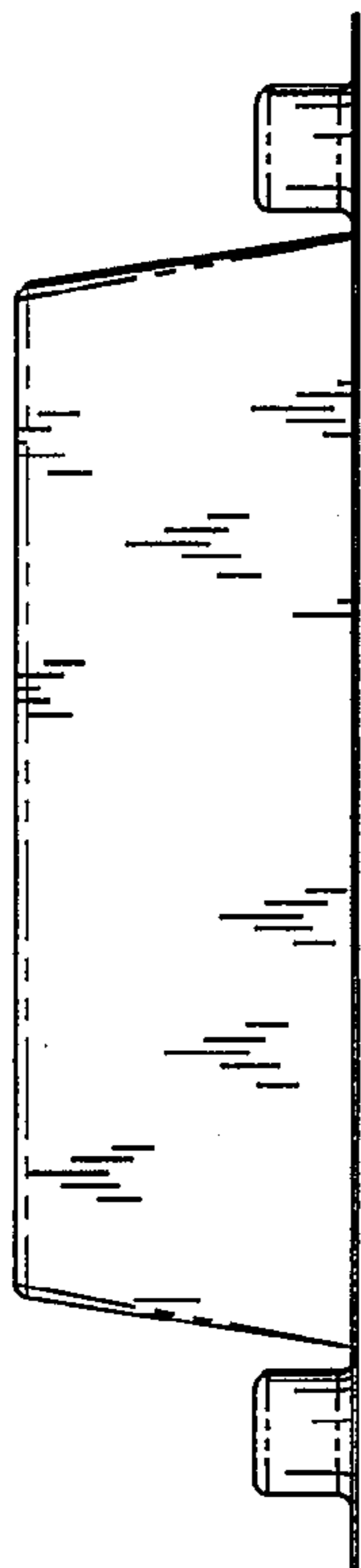

Fig. 19

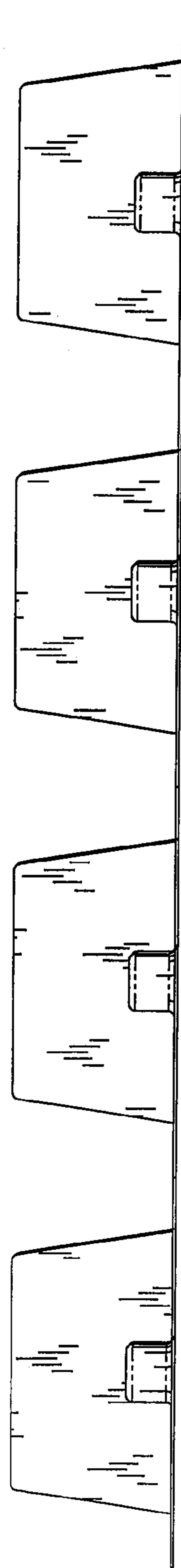

Fig. 20

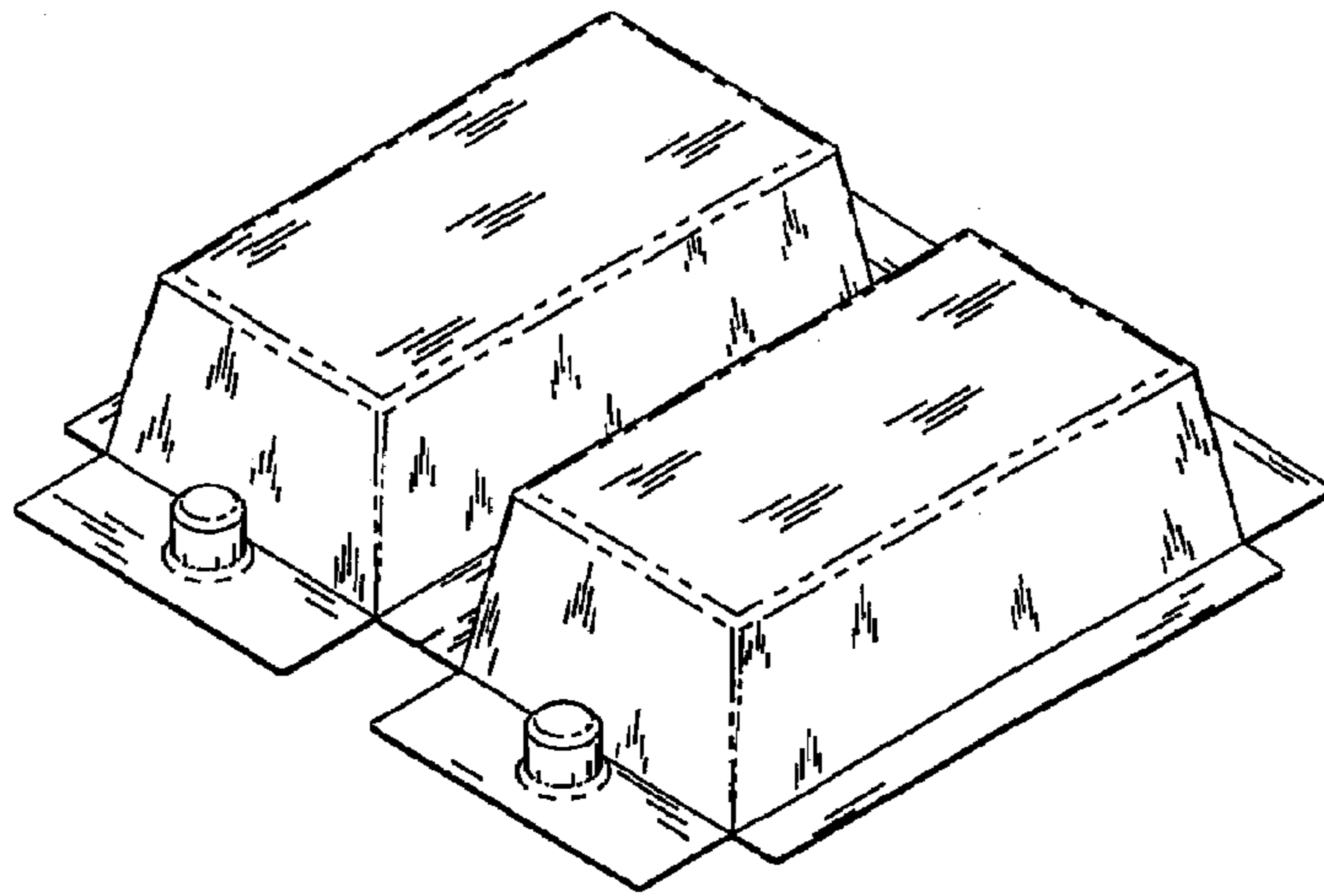

Fig. 21

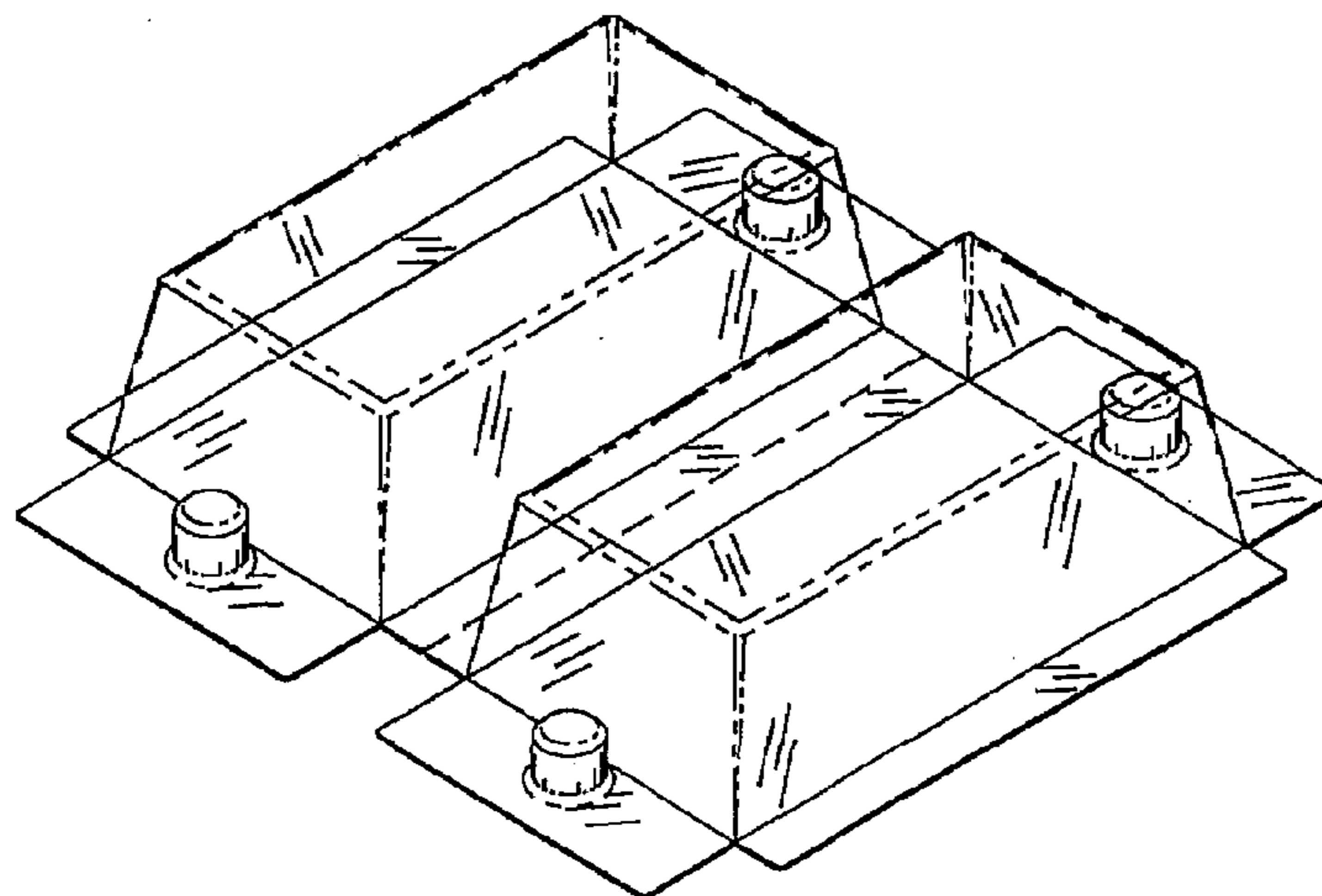

Fig. 40

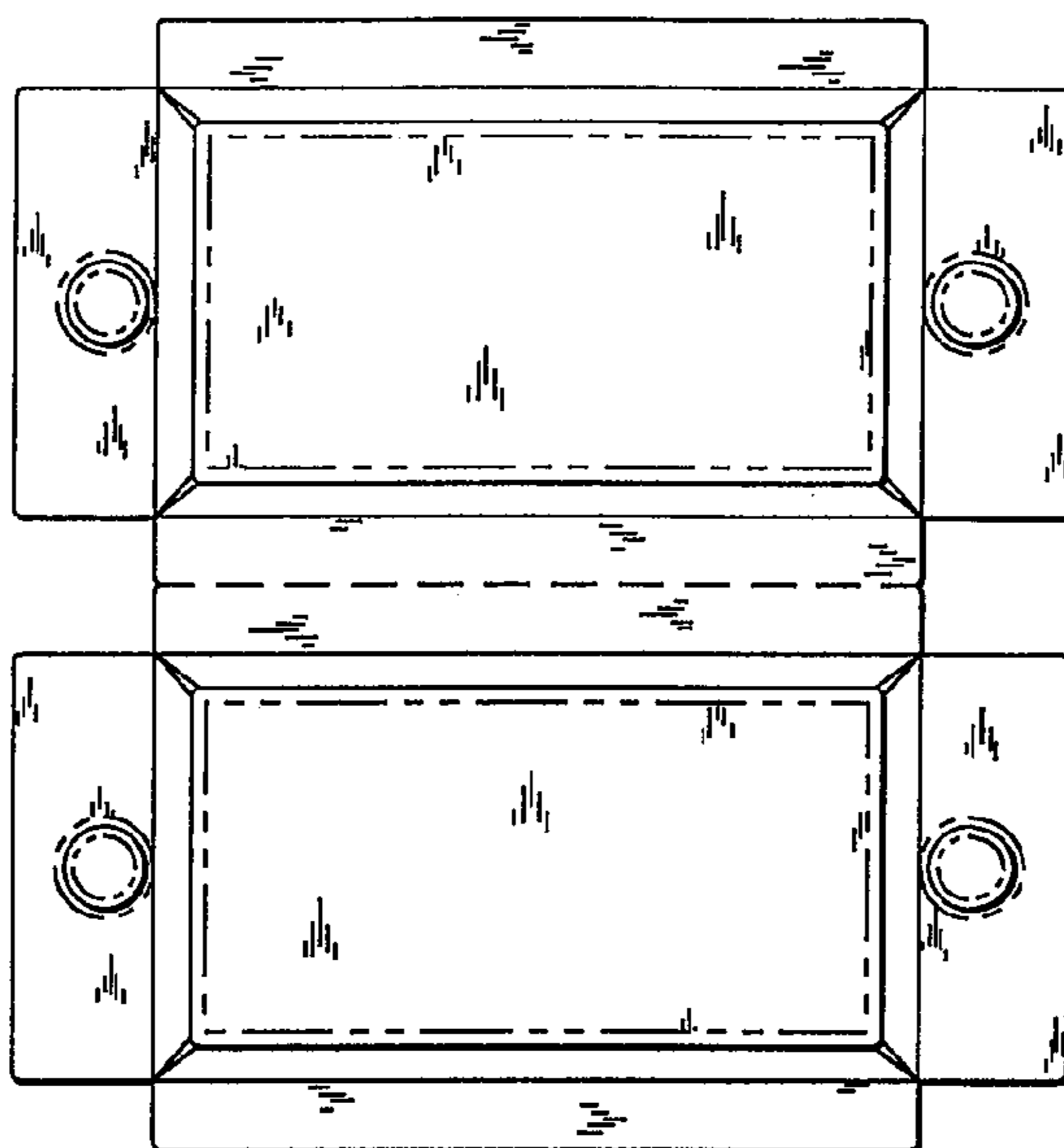

Fig. 22

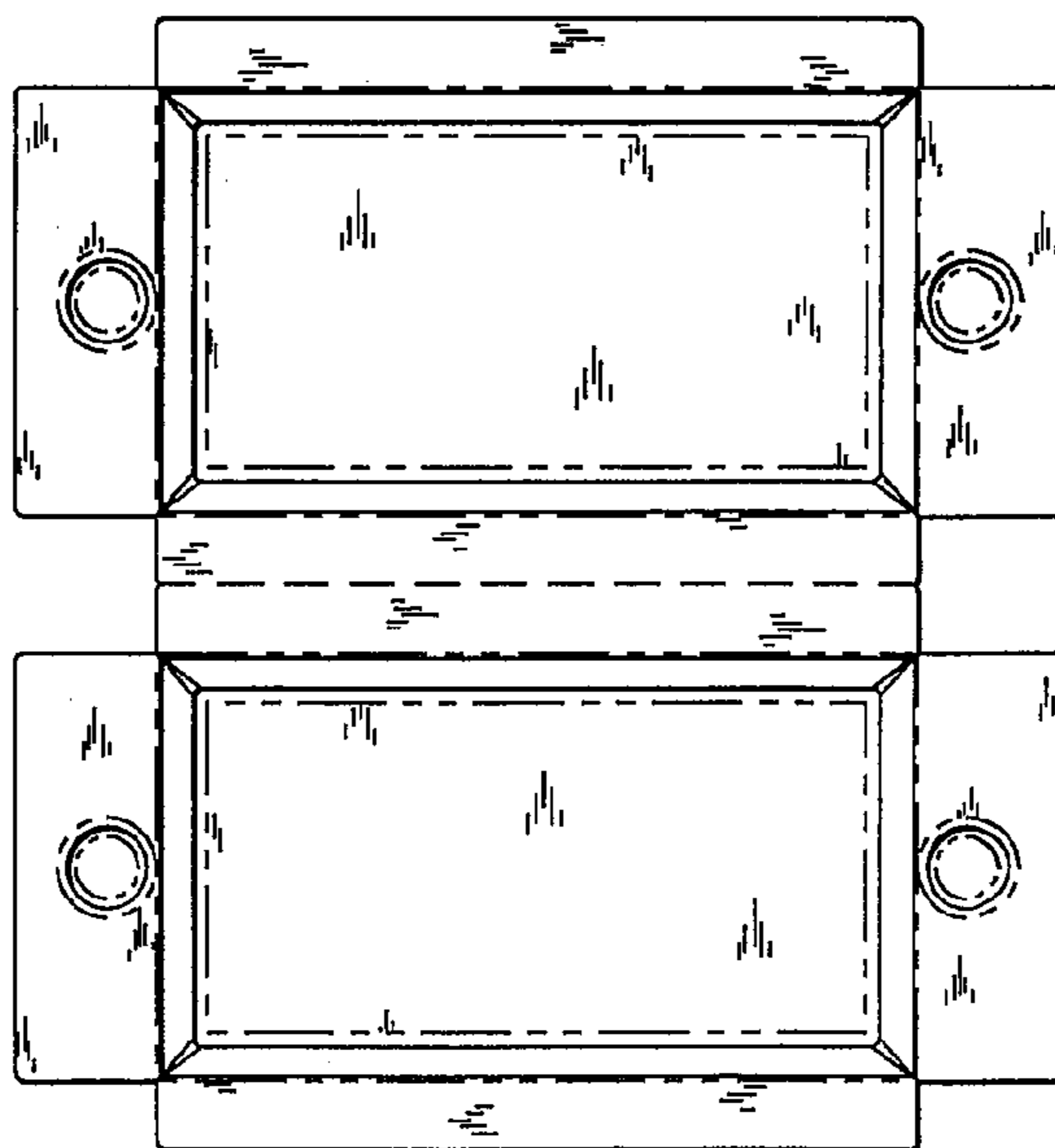

Fig. 23

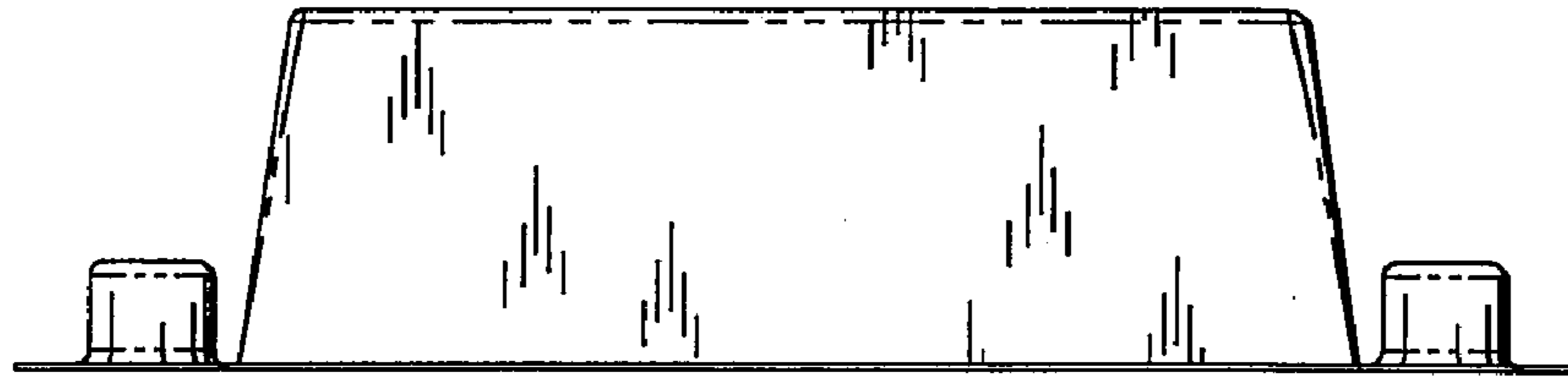

Fig. 24

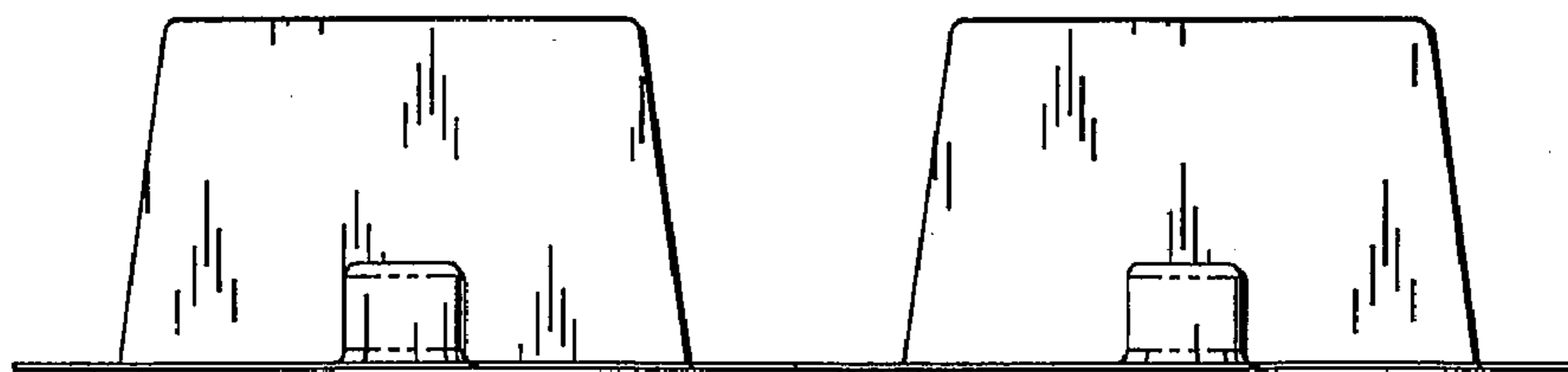

Fig. 25

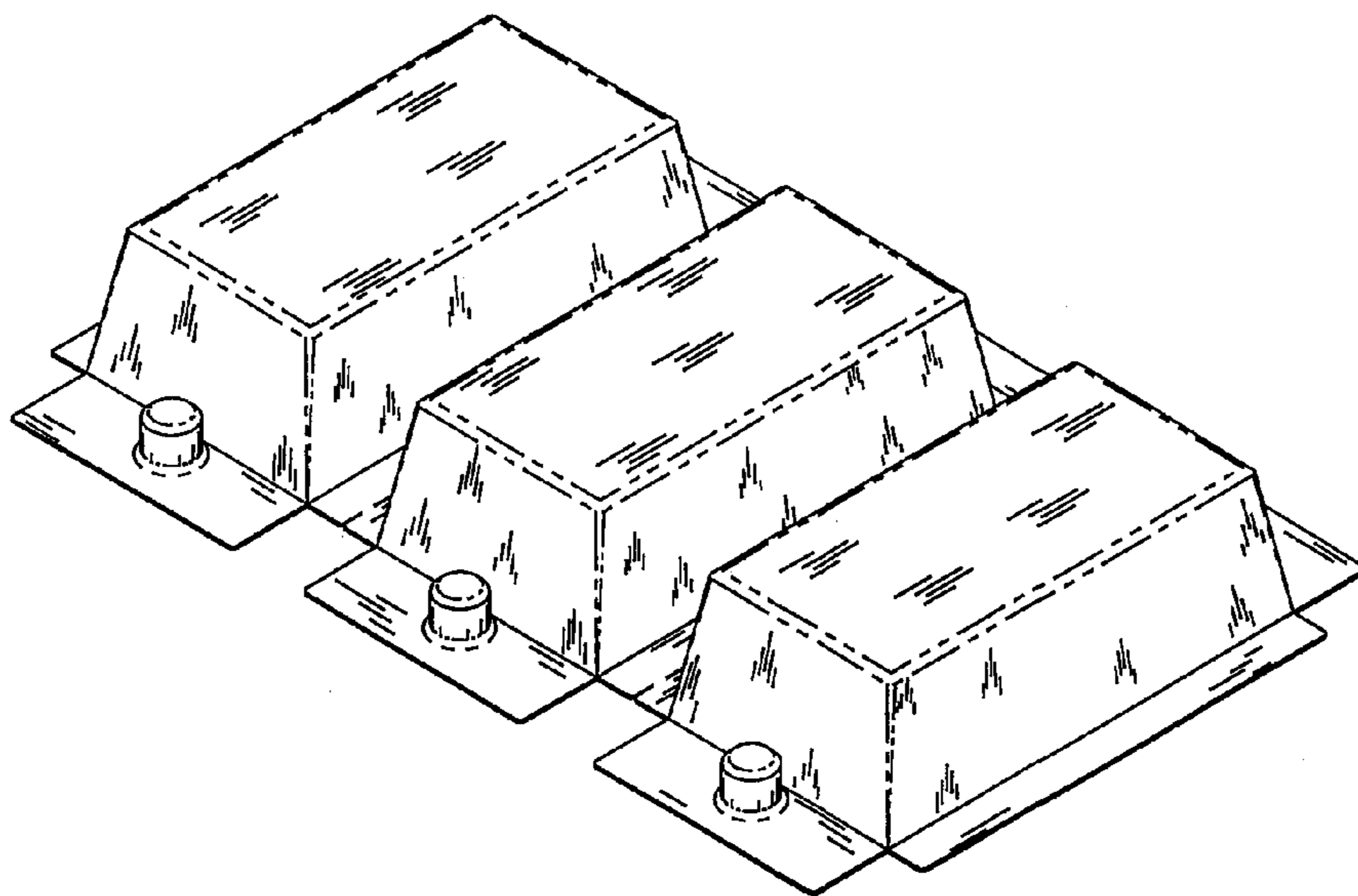

Fig. 26

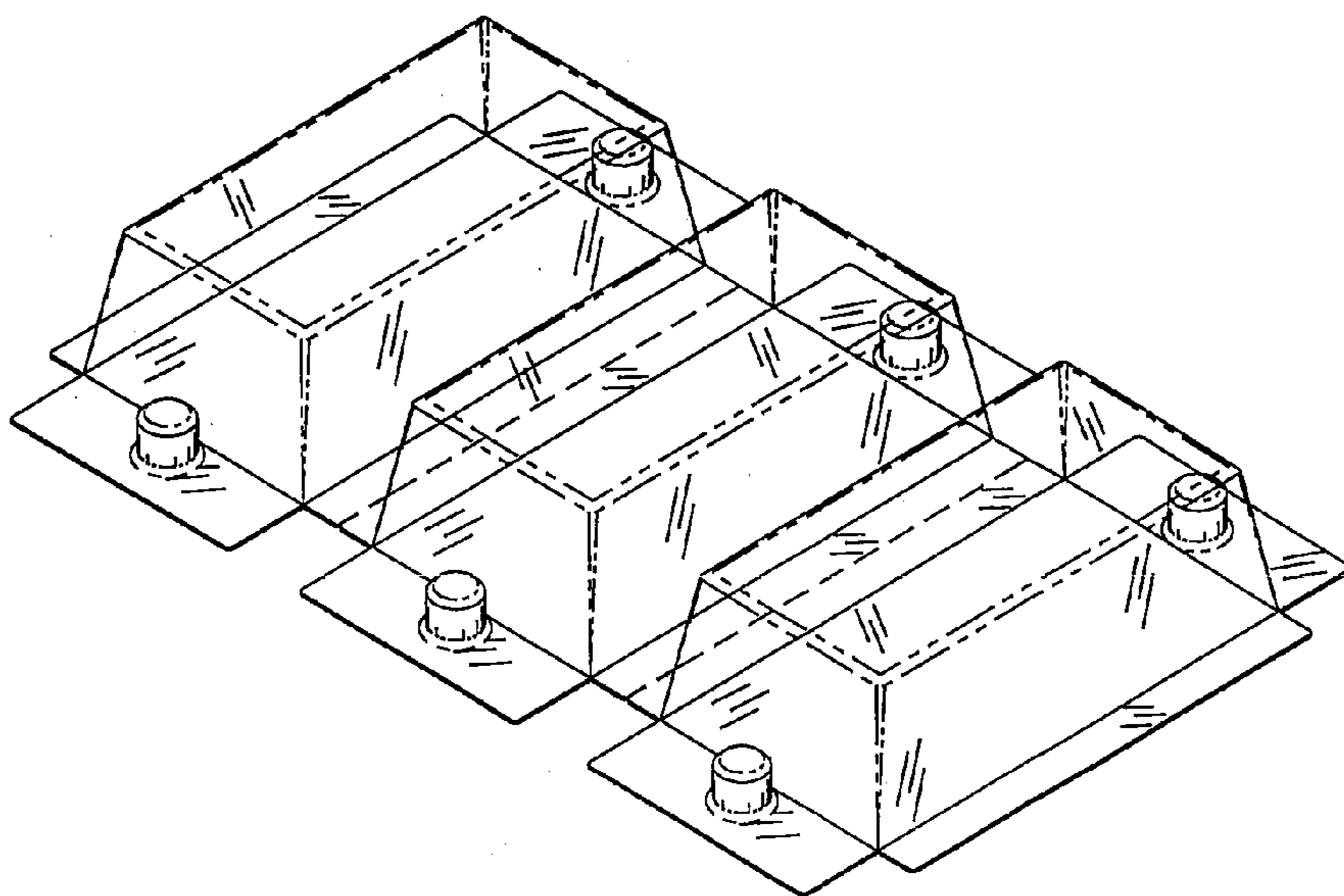

Fig. 41

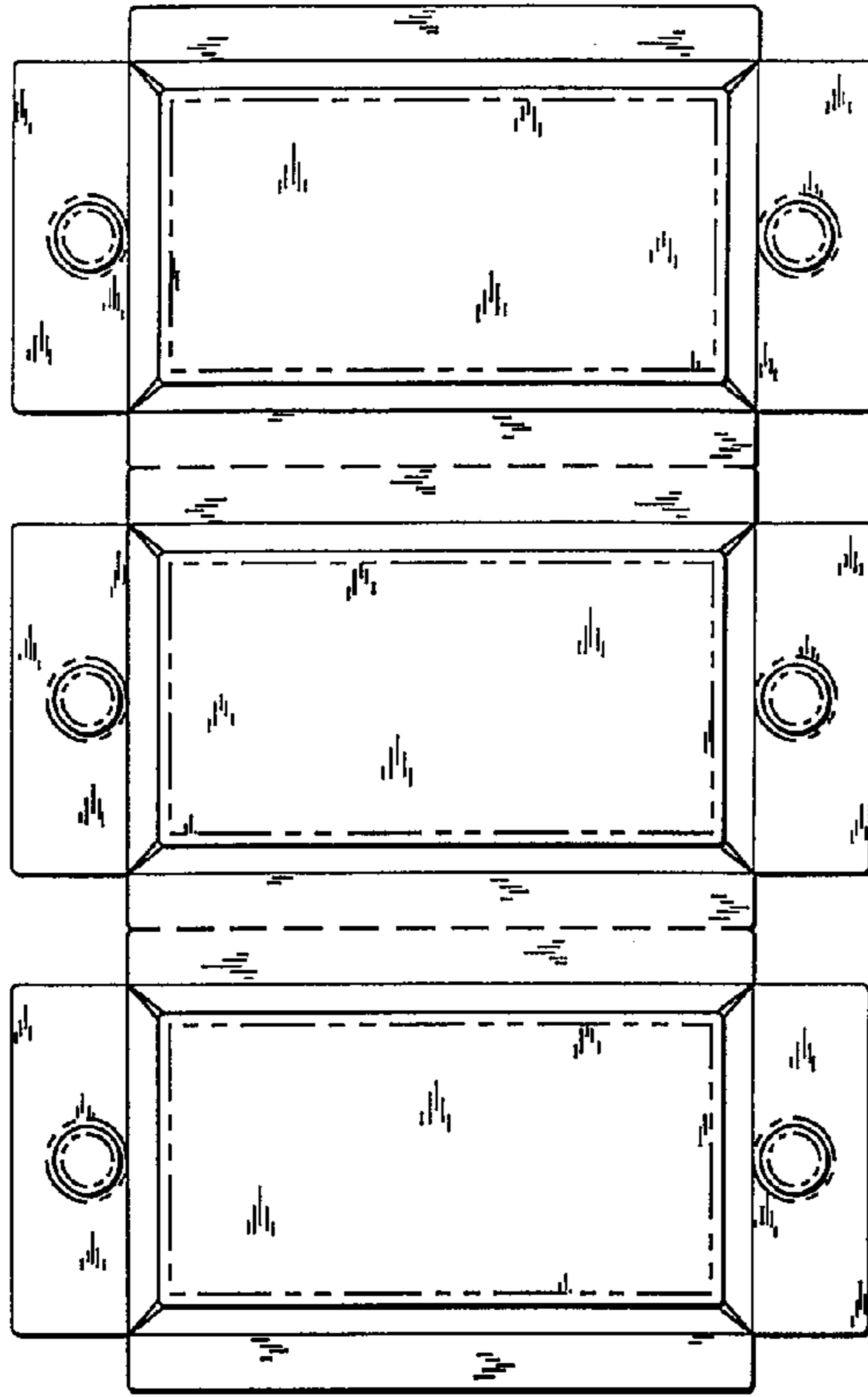

Fig. 27

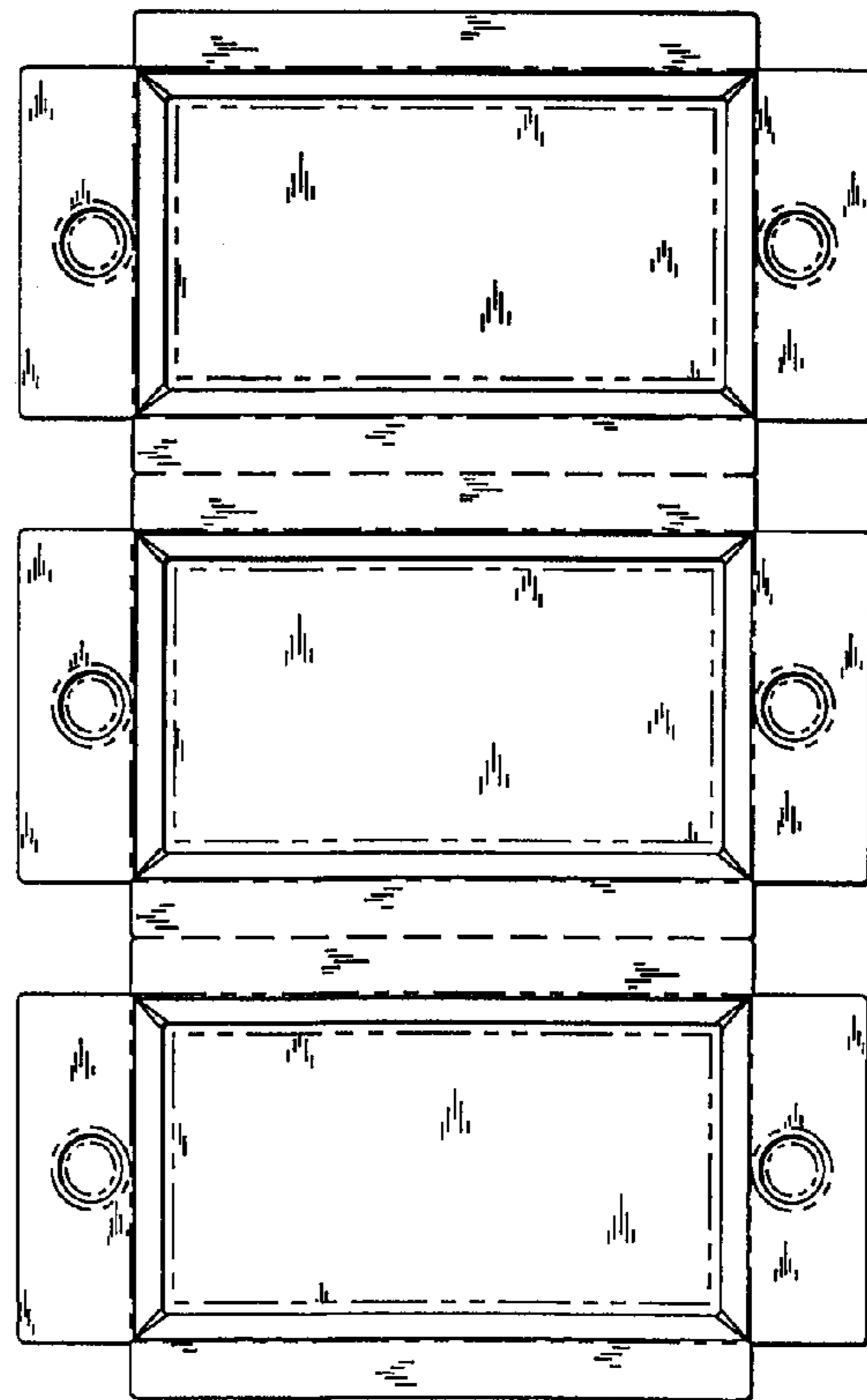

Fig. 28

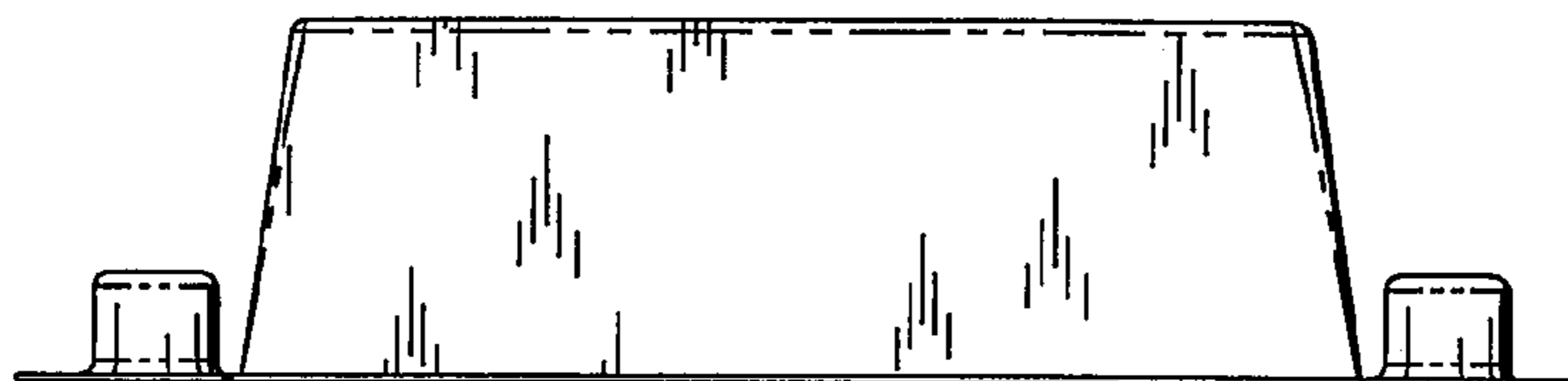

Fig. 29

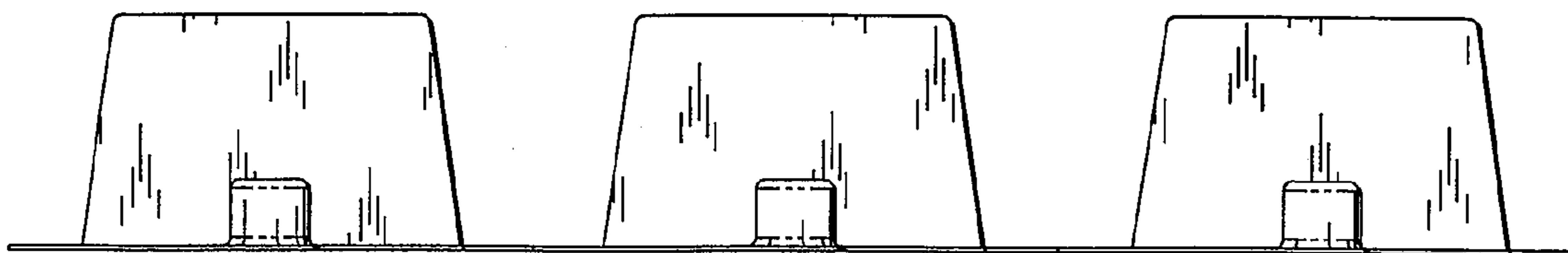

Fig. 30

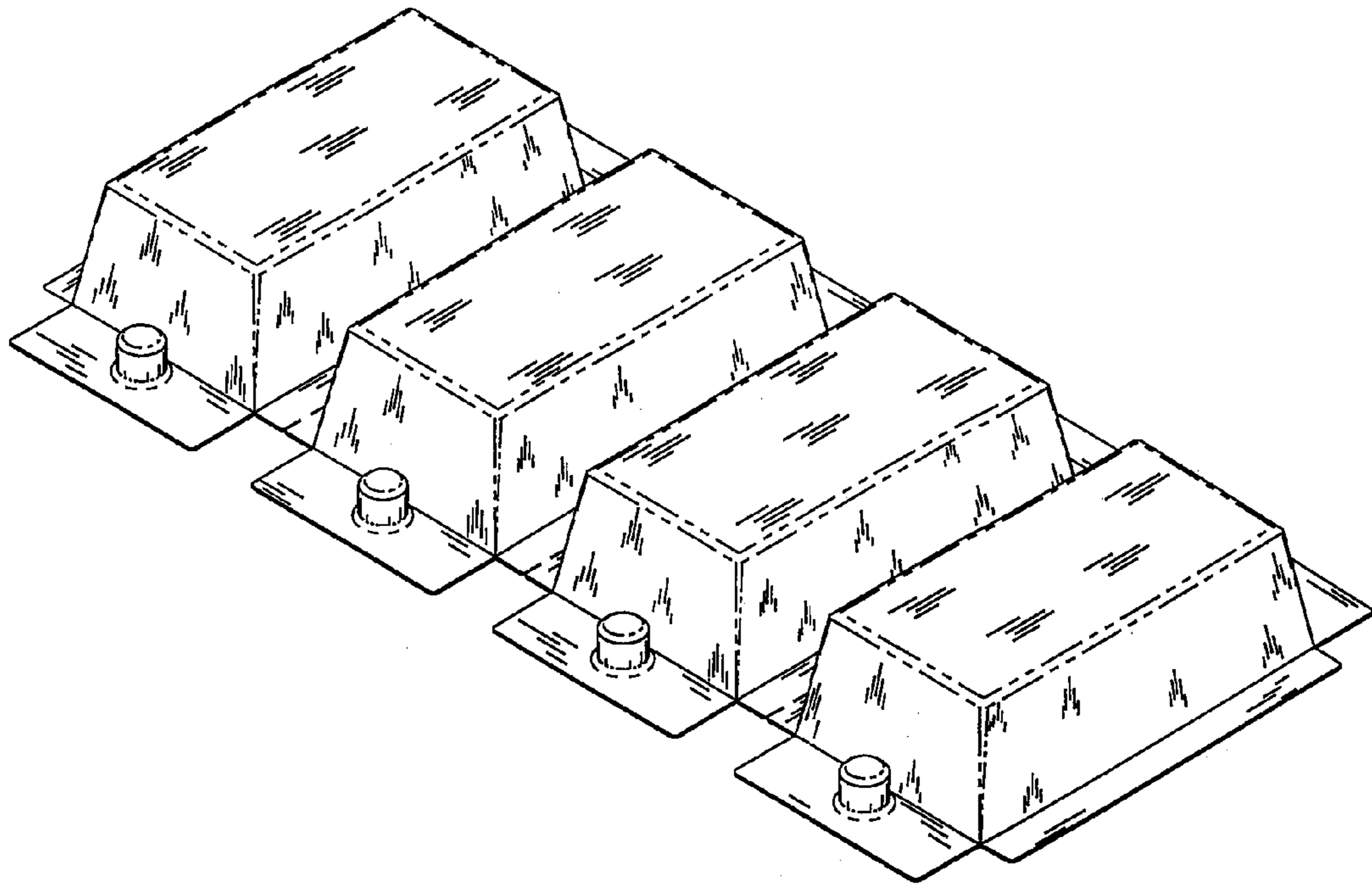

Fig. 31

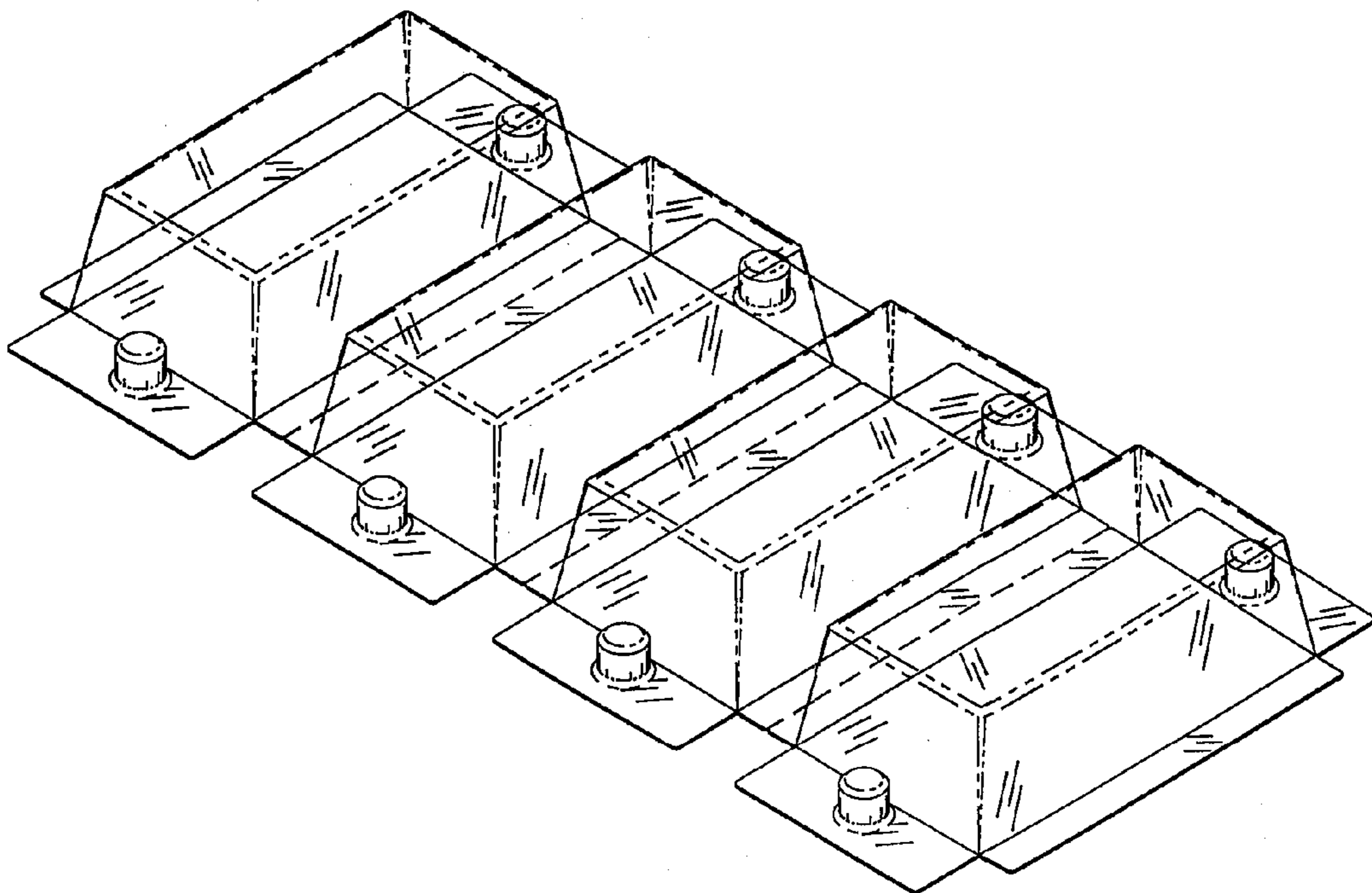

Fig. 42

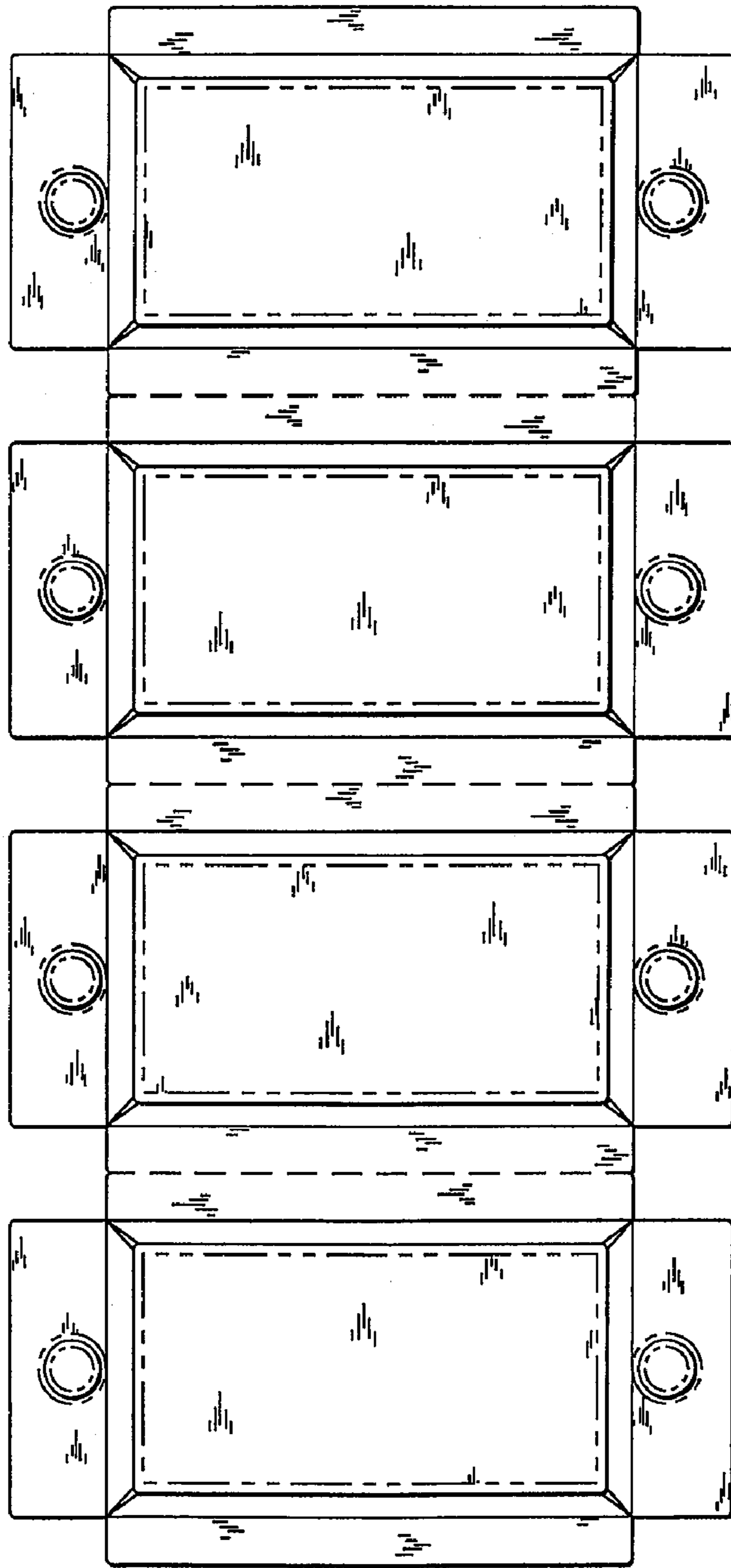

Fig. 32

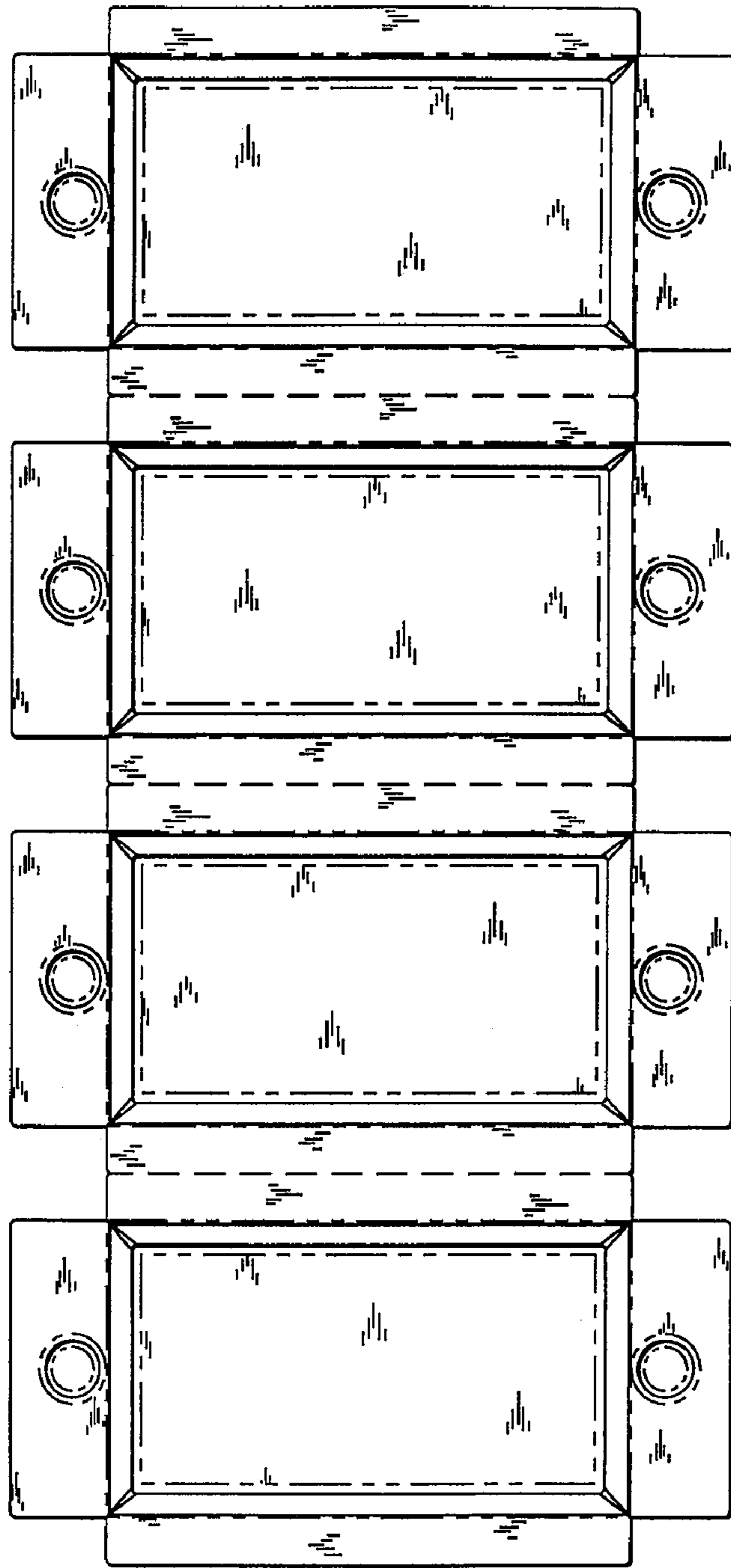

Fig. 33

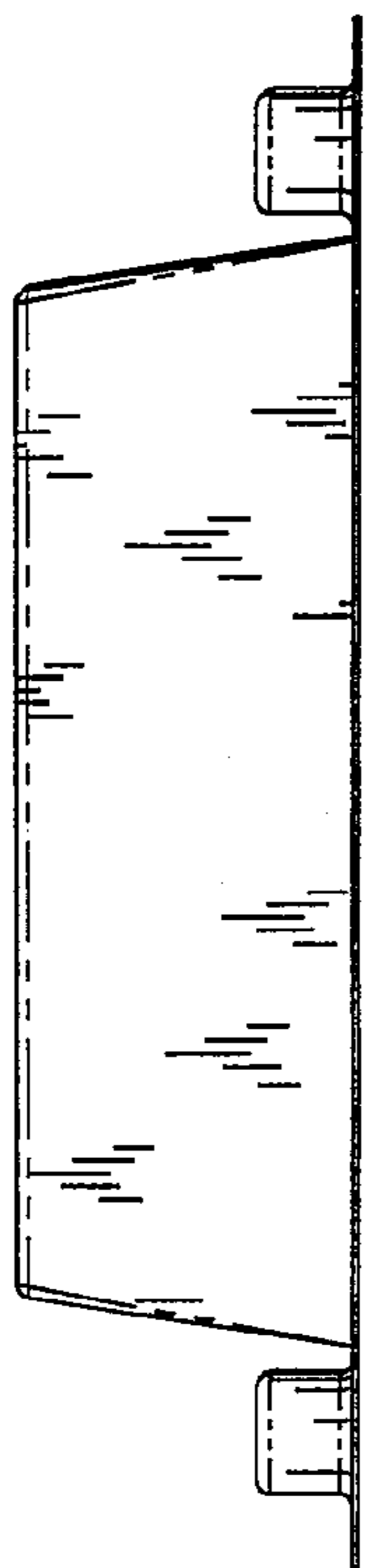

Fig. 34

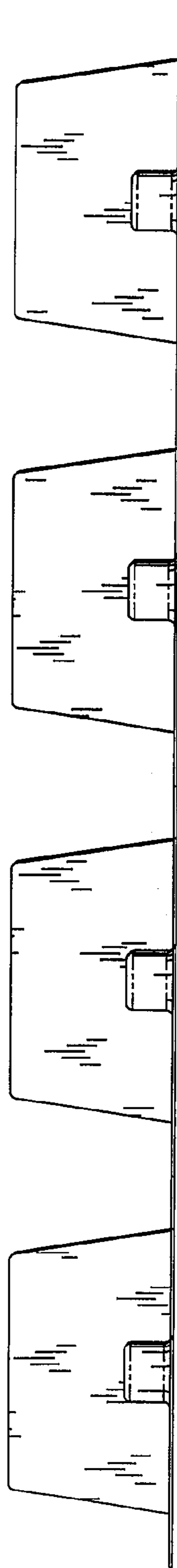

Fig. 35