



US00D573086S

(12) **United States Design Patent**
Kumthampinij et al.

(10) **Patent No.:** **US D573,086 S**
(45) **Date of Patent:** **** Jul. 15, 2008**

(54) **BATTERY CASE**

(75) Inventors: **Yos Kumthampinij**, Edgewater, NJ (US); **Ken Zorovich**, Hoboken, NJ (US); **John Earle**, Annapolis, MD (US); **Cleatis A. Eichelberger**, Mount Laurel, NJ (US)

(73) Assignee: **Princeton Tectonics, Inc.**, Bordentown, NJ (US)

(**) Term: **14 Years**

(21) Appl. No.: **29/291,768**

(22) Filed: **Sep. 13, 2007**

(51) **LOC (8) Cl.** **13-02**

(52) **U.S. Cl.** **D13/103**

(58) **Field of Classification Search** D13/102-106,
D13/110, 118-119, 184; 429/96-100, 163,
429/176

See application file for complete search history.

(56) **References Cited**

U.S. PATENT DOCUMENTS

D283,888 S *	5/1986	Claxton et al.	D13/103
D300,132 S *	3/1989	Culbertson et al.	D13/103
4,880,712 A *	11/1989	Gordecki	429/97
D346,579 S *	5/1994	Mohri	D13/103
D348,044 S *	6/1994	Alexandres et al.	D13/103
D379,795 S *	6/1997	Pitzen et al.	D13/103
D383,435 S *	9/1997	Svetlik	D13/103
D383,725 S *	9/1997	Settsu	D13/103

D390,531 S *	2/1998	Schumacher	D13/103
D428,384 S *	7/2000	Maeyama	D13/103
D514,060 S *	1/2006	Wong et al.	D13/103
D562,227 S *	2/2008	Yamada et al.	D13/103
D562,228 S *	2/2008	Okada et al.	D13/103

OTHER PUBLICATIONS

U.S. Appl. No. 29/291,769 by inventors Kumthampinij, et al. filed Sep. 13, 2007.*

U.S. Appl. No. 29/291,772 by inventors Kumthampinij, et al. filed Sep. 13, 2007.*

* cited by examiner

Primary Examiner—Cathron Brooks

Assistant Examiner—Rosemary K Tarcza

(74) *Attorney, Agent, or Firm*—Howson & Howson LLP

(57) **CLAIM**

The ornamental design for a battery case, as shown and described.

DESCRIPTION

FIG. 1 is a perspective view of a battery case, showing our new design;

FIG. 2 is a top plan view thereof;

FIG. 3 is a left side elevational view thereof;

FIG. 4 is a front elevational view thereof;

FIG. 5 is a right side elevational view thereof;

FIG. 6 is a rear elevational view thereof; and,

FIG. 7 is a bottom plan view thereof.

1 Claim, 3 Drawing Sheets

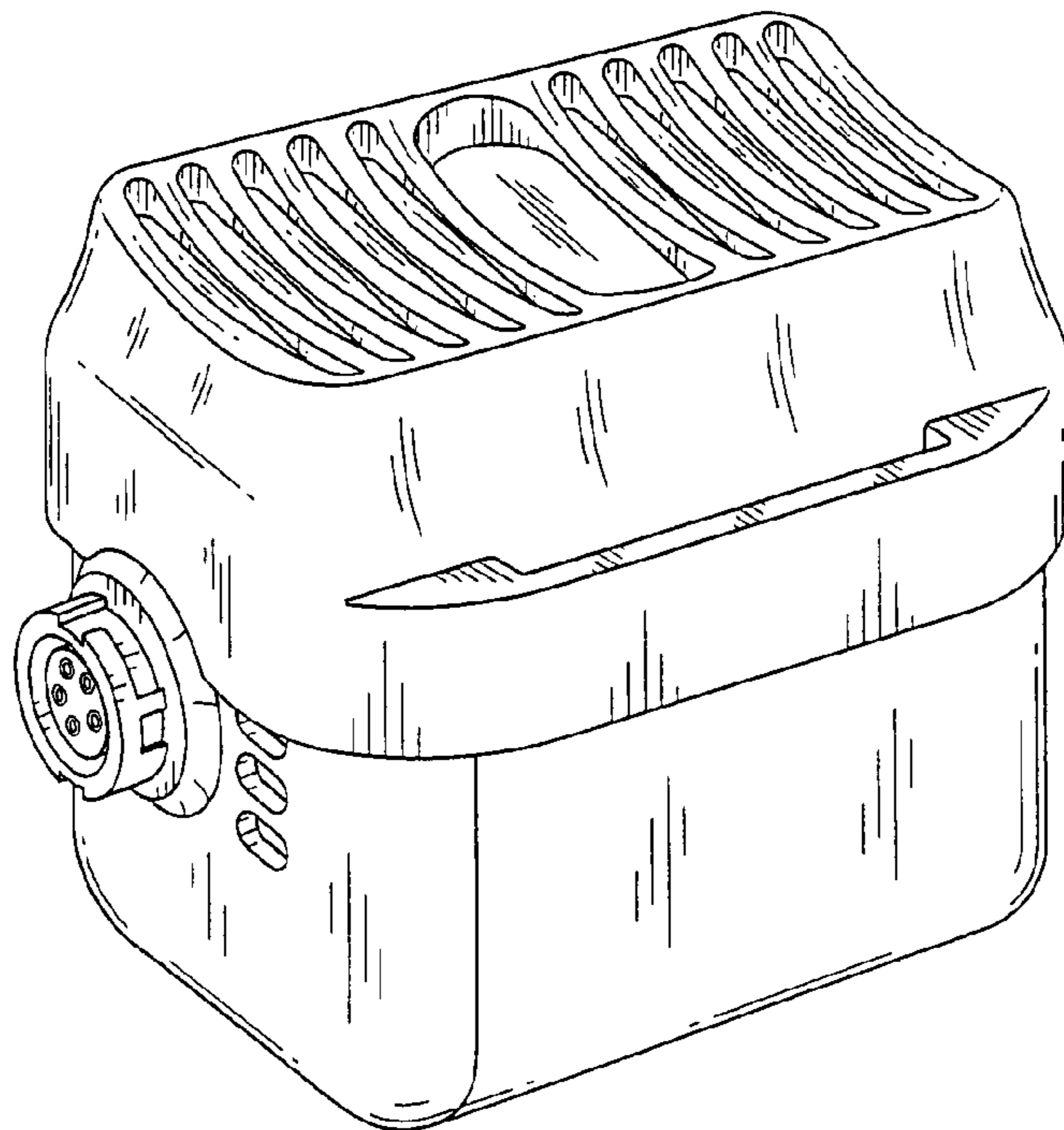

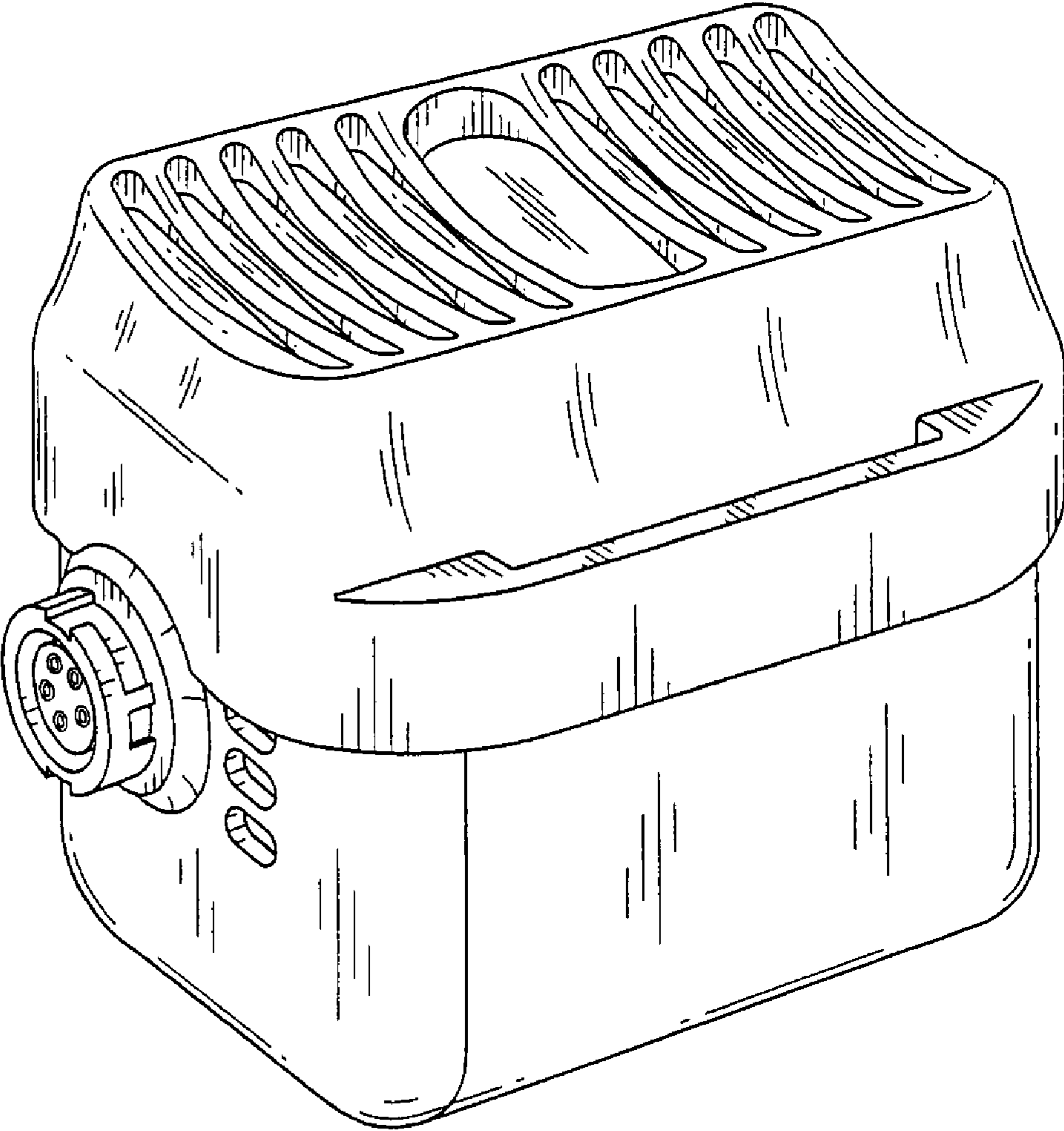

Fig. 1

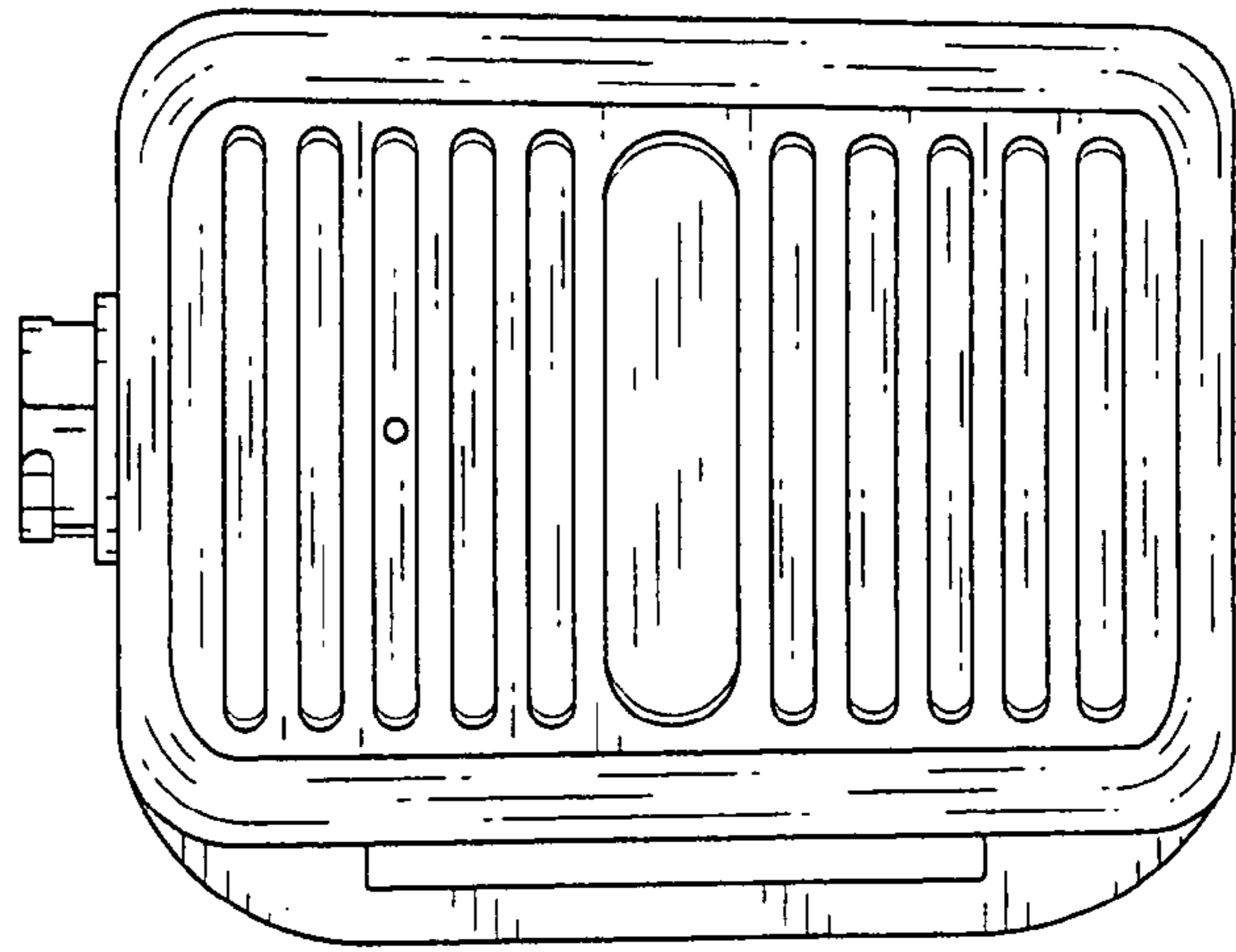

Fig. 2

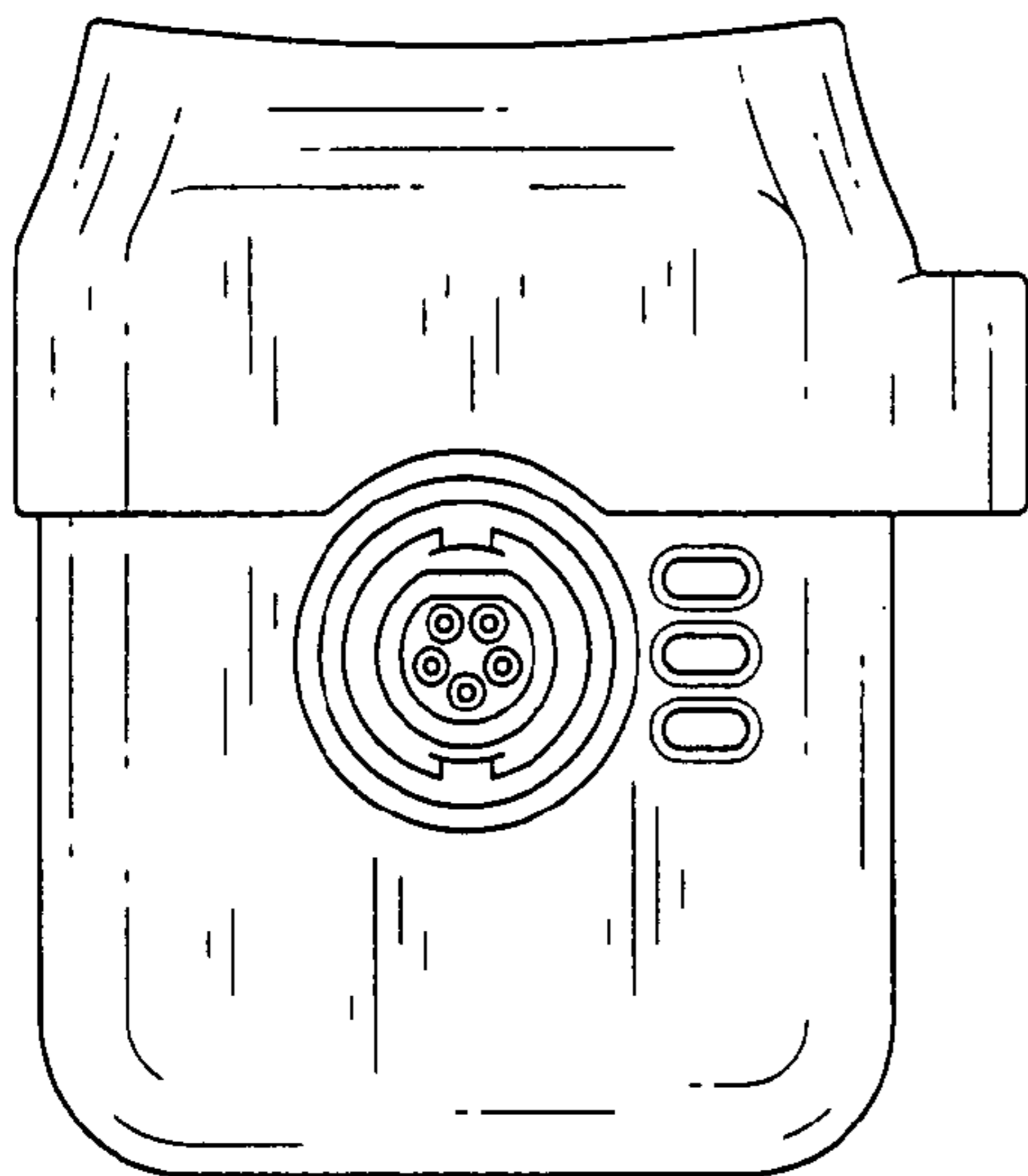

Fig. 3

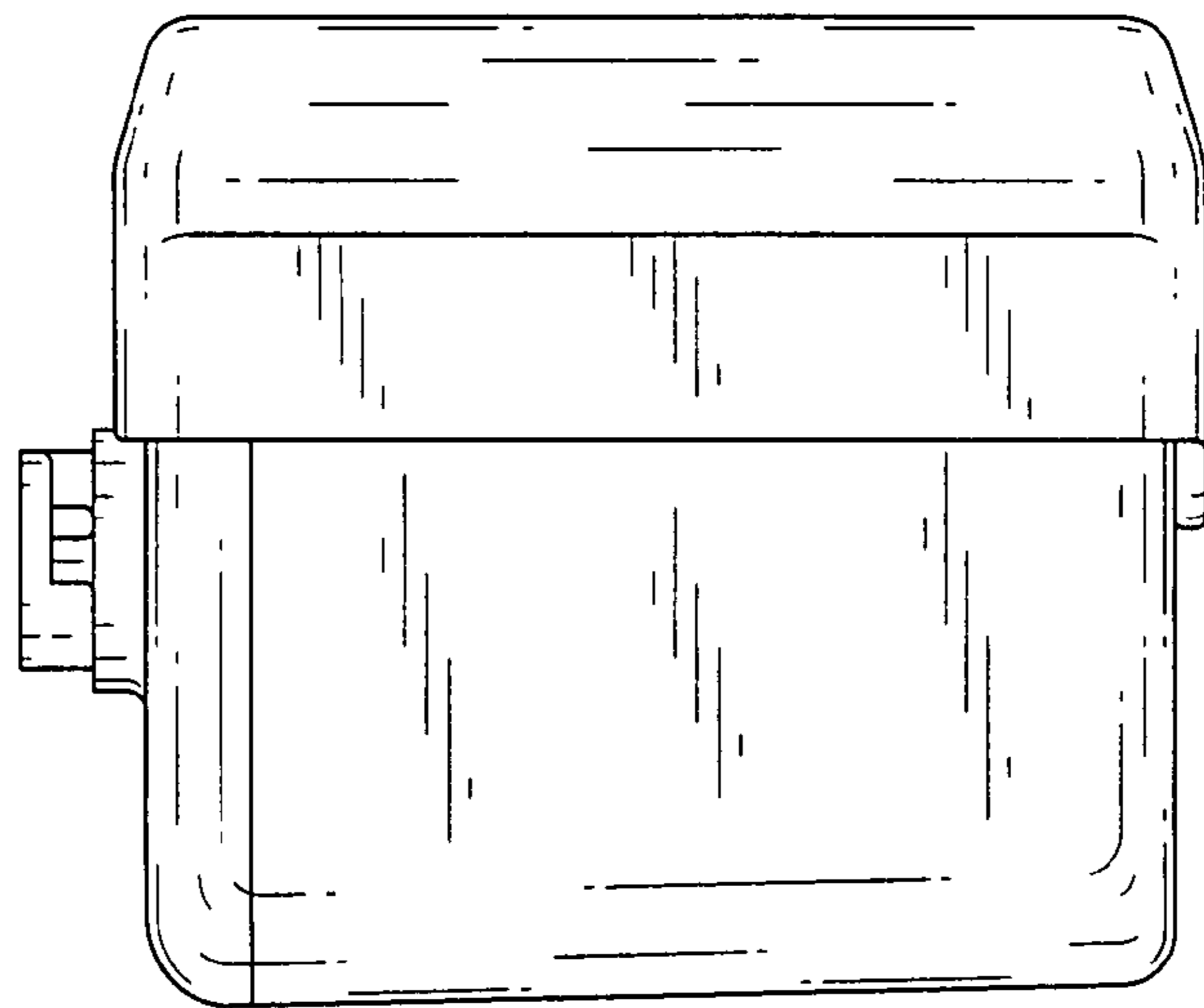

Fig. 4

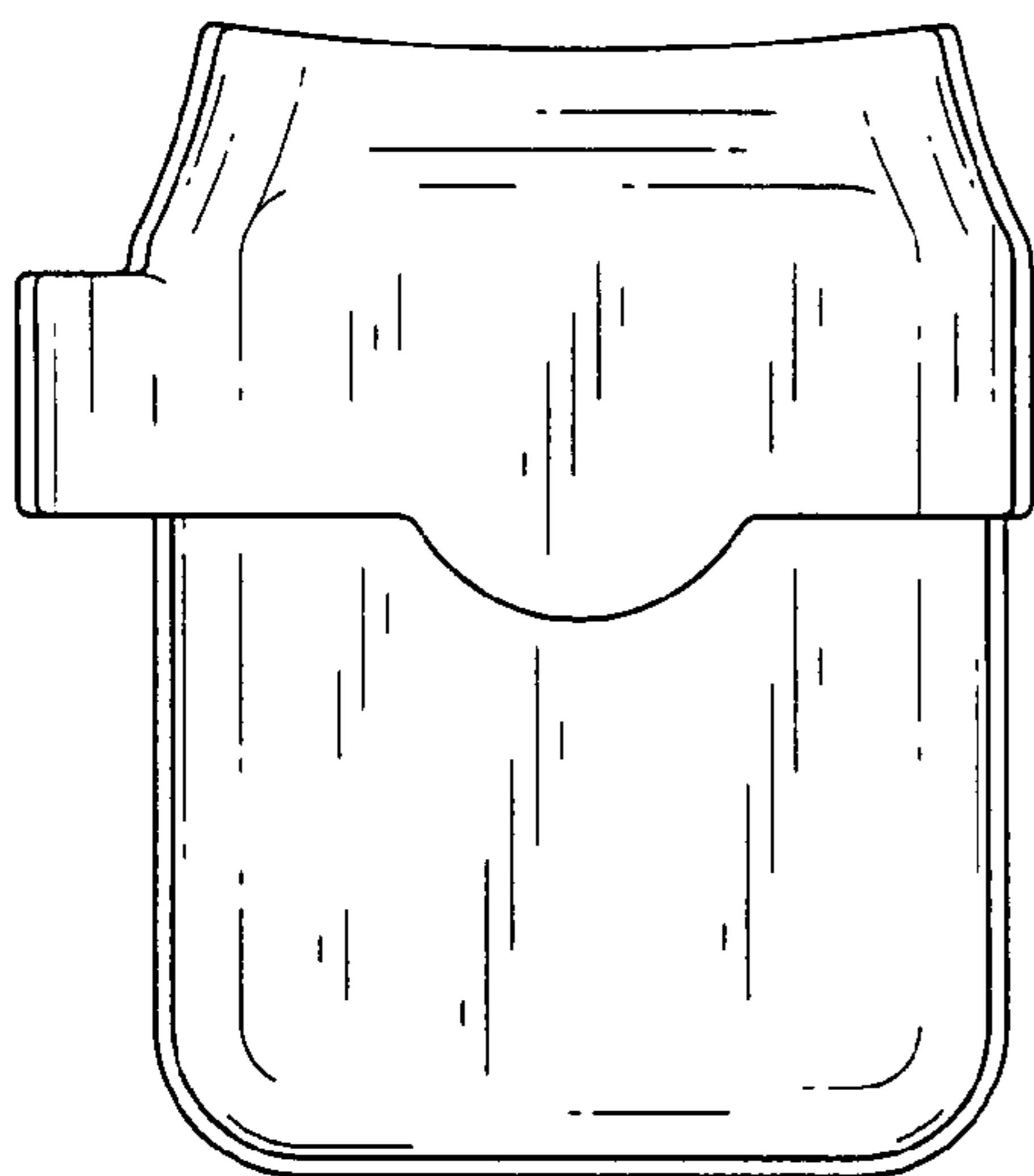

Fig. 5

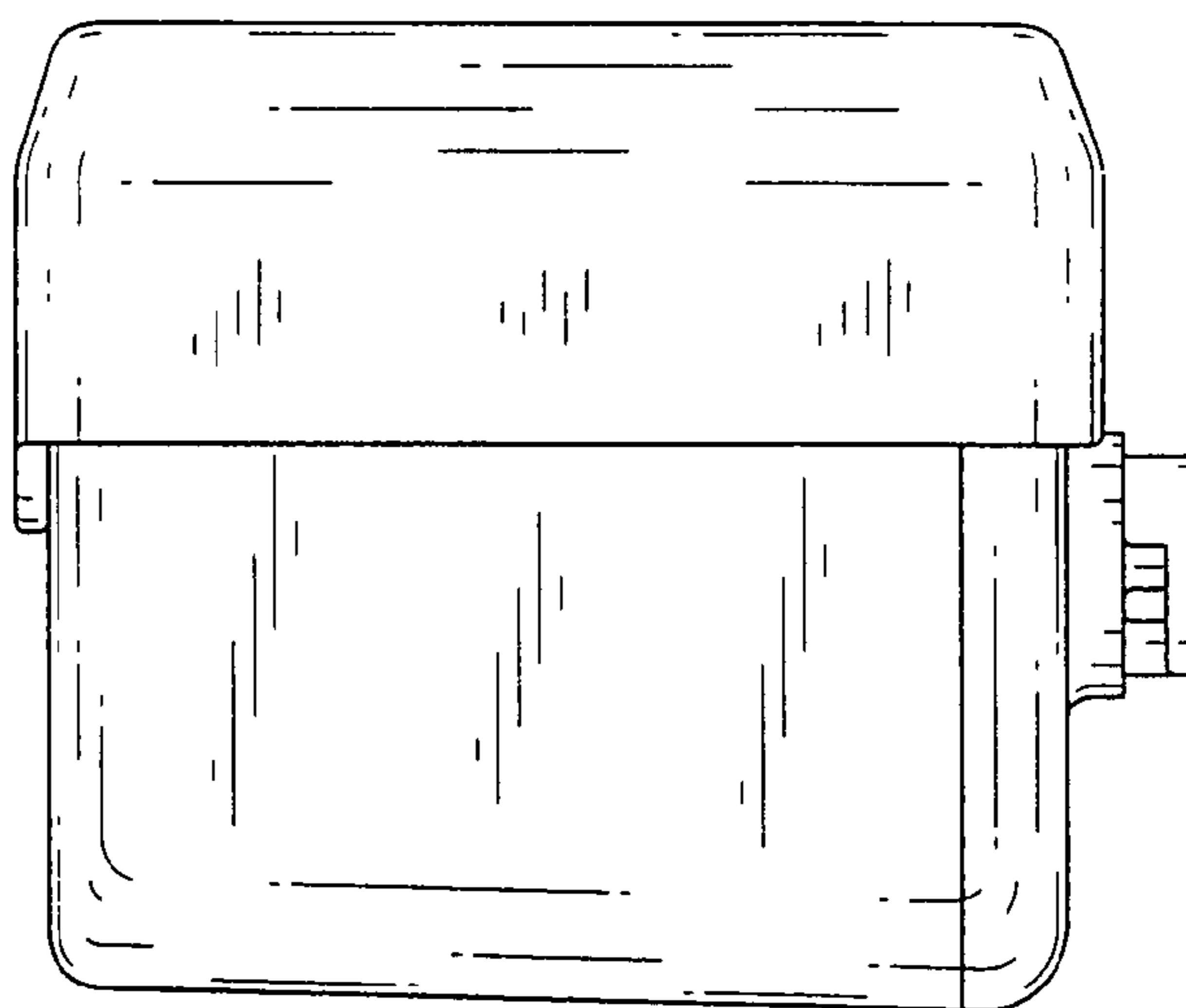

Fig. 6

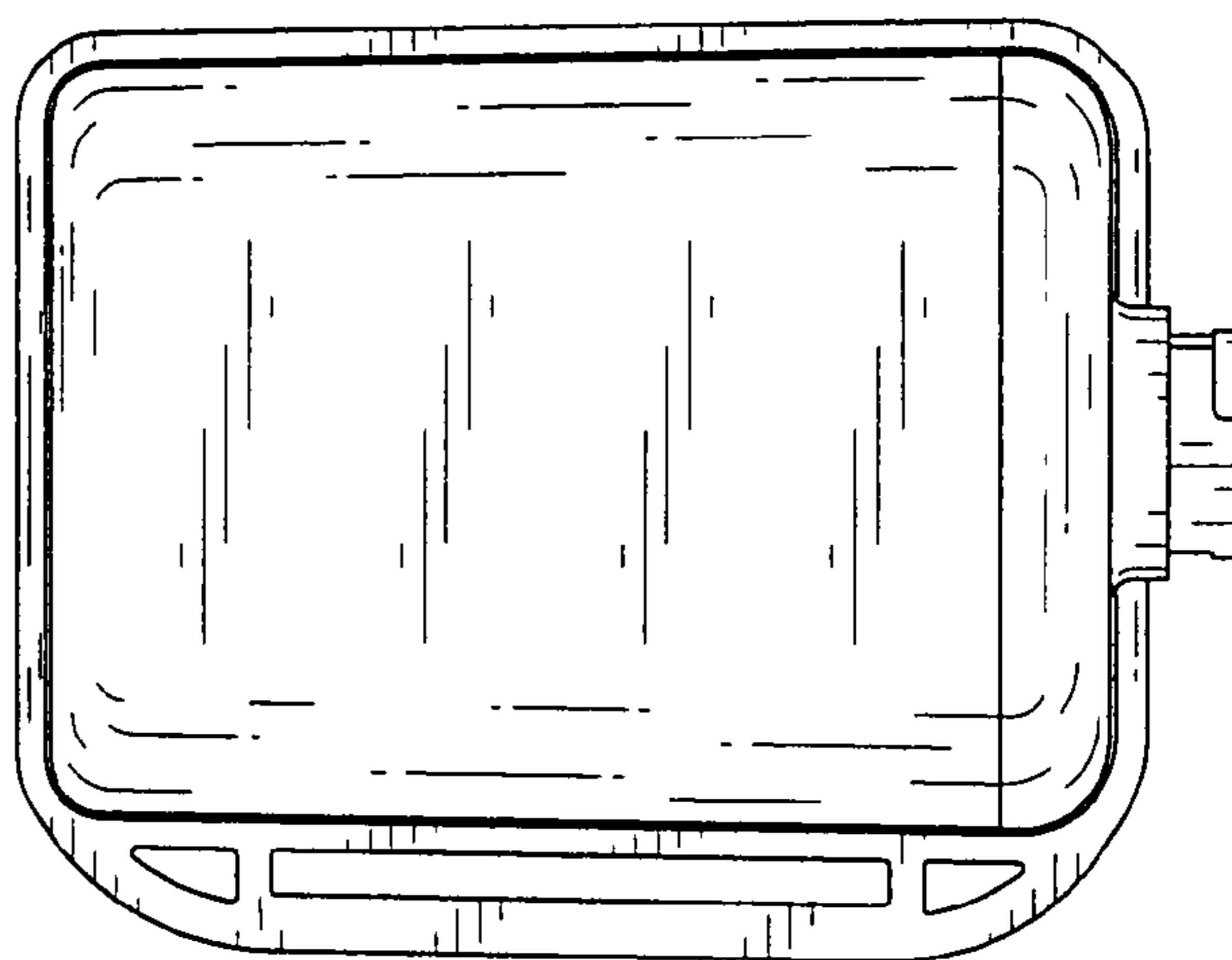

Fig. 7