



US00D573034S

(12) **United States Design Patent**  
**Py et al.**

(10) **Patent No.:** **US D573,034 S**  
(45) **Date of Patent:** **\*\* Jul. 15, 2008**

(54) **DISPENSING CONTAINER**

(75) Inventors: **Daniel Py**, Larchmont, NY (US); **Julian V. Chan**, Spring Valley, NY (US); **Stephanie Ferreira**, Bridgeport, CT (US); **Giovanni Rodriguez**, Stamford, CT (US); **Luz Gladys Valencia**, Stamford, CT (US)

4,050,459 A 9/1977 Sanchez  
4,102,476 A 7/1978 Loeffler  
4,141,474 A 2/1979 Nilson  
4,185,628 A 1/1980 Kopfer  
4,189,065 A 2/1980 Herold  
4,233,262 A 11/1980 Curto  
4,239,132 A 12/1980 Mueller et al.  
4,240,465 A 12/1980 Rader

(73) Assignee: **Medical Instill Technologies, Inc.**, New Milford, CT (US)

(Continued)

(\*\*) Term: **14 Years**

FOREIGN PATENT DOCUMENTS

EP 0802827 B1 12/1998

(21) Appl. No.: **29/297,161**

(Continued)

(22) Filed: **Nov. 5, 2007**

**Related U.S. Application Data**

(62) Division of application No. 29/237,484, filed on Sep. 1, 2005, now Pat. No. Des. 554,525, which is a division of application No. 29/198,293, filed on Jan. 27, 2004, now Pat. No. Des. 512,646.

*Primary Examiner*—Stella M. Reid  
*Assistant Examiner*—Rashida C McCoy  
(74) *Attorney, Agent, or Firm*—McCarter & English, LLP

(51) **LOC (8) Cl.** ..... **09-01**

(52) **U.S. Cl.** ..... **D9/686; D9/688; D9/689**

(58) **Field of Classification Search** ..... D2/452,  
D2/502–504, 522–529, 549, 682, 686–692;  
D28/73, 76

See application file for complete search history.

(57) **CLAIM**

The ornamental design for a dispensing container, as shown and described.

(56) **References Cited**

U.S. PATENT DOCUMENTS

1,471,091 A 10/1923 Bessesen  
2,128,035 A 8/1938 Boetel  
3,412,910 A 11/1968 Hahn  
3,648,903 A 3/1972 Marchant  
3,662,753 A 5/1972 Tassell  
3,669,323 A 6/1972 Harker et al.  
3,699,961 A 10/1972 Szpur  
3,756,729 A 9/1973 Tufts  
3,993,069 A 11/1976 Buckles et al.  
4,002,516 A 1/1977 Gaborieau et al.  
4,023,607 A 5/1977 Jensen et al.

**DESCRIPTION**

FIG. 1 is a side elevational view of a dispensing container showing our new design;  
FIG. 2 is a side elevational view thereof rotated 180 degrees;  
FIG. 3 is a side elevational view thereof rotated 90 degrees;  
FIG. 4 is a side elevational view thereof rotated 270 degrees;  
FIG. 5 is a side and top perspective view thereof;  
FIG. 6 is a side and bottom perspective view thereof;  
FIG. 7 is a top plan view thereof; and,  
FIG. 8 is a bottom plan view thereof.

The broken lines are included for the purpose of illustrating boundaries of the invention and form no part of the claimed design.

**1 Claim, 8 Drawing Sheets**

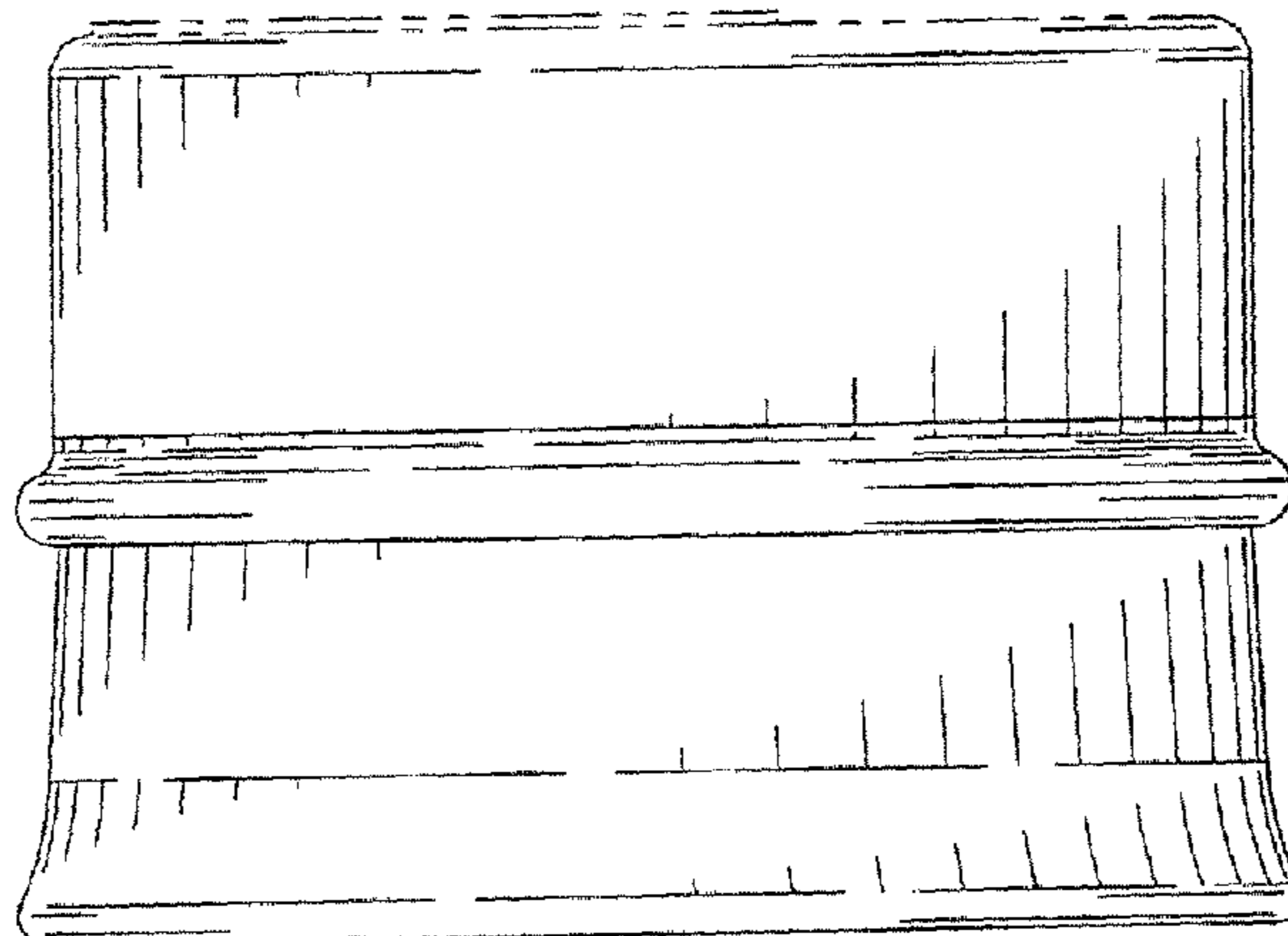

US D573,034 S

U.S. PATENT DOCUMENTS							
4,264,018	A	4/1981	Warren	5,615,795	A	4/1997	Tipps
4,367,739	A	1/1983	LeVeen et al.	5,630,800	A	5/1997	Blank et al.
4,420,100	A	12/1983	Mueller	5,636,930	A	6/1997	Holloway
4,458,830	A	7/1984	Werdning	5,641,004	A	6/1997	Py
4,475,905	A	10/1984	Himmelstrup	5,664,704	A	9/1997	Meadows et al.
4,479,578	A	10/1984	Brignola et al.	5,676,267	A	10/1997	Slat et al.
4,479,989	A	10/1984	Mahal	5,687,882	A	11/1997	Mueller
4,482,585	A	11/1984	Ohodaira et al.	5,692,651	A	12/1997	Fuchs
4,493,348	A	1/1985	Lemmons	5,702,019	A	12/1997	Grimard
4,501,781	A	2/1985	Kushida et al.	5,718,334	A	2/1998	Demel
4,513,891	A	4/1985	Hain et al.	D392,888	S *	3/1998	Bakic ..... D9/503
4,526,294	A	7/1985	Hirschmann et al.	5,727,892	A	3/1998	Baudin
4,579,757	A	4/1986	Su et al.	5,728,075	A	3/1998	Levander
4,624,594	A	11/1986	Sasaki et al.	5,730,322	A	3/1998	Iba et al.
4,636,412	A	1/1987	Field	5,743,441	A	4/1998	Baudin et al.
4,643,723	A	2/1987	Smit	5,743,889	A	4/1998	Sams
4,699,300	A	10/1987	Blake	5,772,347	A	6/1998	Gueret
4,700,838	A	10/1987	Falciani et al.	5,780,130	A	7/1998	Hansen et al.
4,737,148	A	4/1988	Blake	5,785,683	A	7/1998	Szapiro et al.
4,739,906	A	4/1988	LoTurco	5,799,837	A	9/1998	Firestone et al.
4,776,717	A	10/1988	Iizuka et al.	5,803,311	A	9/1998	Fuchs
4,784,652	A	11/1988	Wikström	5,804,236	A	9/1998	Frisk
4,842,165	A	6/1989	Van Coney	5,823,397	A	10/1998	Gil
4,854,481	A	8/1989	Bohl et al.	5,829,901	A	11/1998	Brown et al.
4,854,486	A	8/1989	Daley et al.	D402,894	S *	12/1998	Elia ..... D9/504
4,865,591	A	9/1989	Sams	5,855,302	A	1/1999	Fisscher
4,895,279	A	1/1990	Schultz	5,876,372	A	3/1999	Grabenkort et al.
4,903,741	A	2/1990	Ibanez	5,879,095	A	3/1999	Gueret
4,910,147	A	3/1990	Bacehowski et al.	5,879,336	A	3/1999	Brinon
4,936,833	A	6/1990	Sams	5,899,624	A	5/1999	Thompson
4,949,877	A	8/1990	Hanna et al.	5,931,386	A	8/1999	Jouillat
4,962,868	A	10/1990	Borchard	5,934,500	A	8/1999	Cogger et al.
4,973,318	A	11/1990	Holm et al.	RE36,410	E	11/1999	Meshberg
4,978,036	A	12/1990	Burd	6,004,298	A	12/1999	Levander
5,033,647	A	7/1991	Smith et al.	6,050,444	A	4/2000	Sugg
5,083,416	A	1/1992	Schneider et al.	6,053,370	A	4/2000	Ludbrook et al.
5,102,705	A	4/1992	Yamoto et al.	6,062,430	A	5/2000	Fuchs
5,108,007	A	4/1992	Smith et al.	6,062,437	A	5/2000	Mascitelli
5,178,300	A	1/1993	Haviv et al.	6,083,201	A	7/2000	Skinkle
5,197,638	A	3/1993	Wood	6,083,450	A	7/2000	Safian
5,226,568	A	7/1993	Newton et al.	6,145,707	A	11/2000	Baudin
5,226,895	A	7/1993	Harris	6,170,705	B1	1/2001	Schneider et al.
5,238,153	A	8/1993	Castillo et al.	6,186,686	B1	2/2001	Neuner et al.
5,244,465	A	9/1993	Michel	6,200,047	B1	3/2001	Holloway
5,253,785	A	10/1993	Haber et al.	6,202,901	B1	3/2001	Gerber et al.
5,290,260	A	3/1994	Stines	6,234,363	B1	5/2001	Stradella
D345,697	S *	4/1994	Dinand ..... D9/520	6,254,579	B1	7/2001	Cogger et al.
5,318,204	A	6/1994	Davis et al.	D448,299	S *	9/2001	Negre ..... D9/502
5,320,256	A	6/1994	Wood	6,325,253	B1	12/2001	Robinson
5,332,121	A	7/1994	Schmidt et al.	6,338,442	B1	1/2002	De Laforcade
5,339,972	A	8/1994	Crosnier et al.	6,343,713	B1	2/2002	Abplanalp
5,360,145	A	11/1994	Gueret	6,351,924	B1	3/2002	Gustafsson et al.
5,416,303	A	5/1995	Grooms et al.	6,357,945	B1	3/2002	Losier et al.
5,419,465	A	5/1995	Schroeder	6,371,129	B1	4/2002	Le Bras-Brown et al.
5,425,465	A	6/1995	Healy	6,383,167	B2	5/2002	Kirchhofer et al.
5,429,254	A	7/1995	Christine	6,386,395	B1	5/2002	Lunghetti
5,489,026	A	2/1996	D'Aloia	6,419,412	B1	7/2002	Ostrowski et al.
5,489,027	A	2/1996	Goerigk	6,446,844	B1	9/2002	Gross
RE35,187	E	3/1996	Gortz	6,450,994	B1	9/2002	Boyles et al.
5,497,910	A	3/1996	Meadows et al.	6,502,725	B1	1/2003	Alexander
5,545,147	A	8/1996	Harris	6,533,482	B1	3/2003	Byun
5,556,678	A	9/1996	Jupin et al.	D474,405	S *	5/2003	Togasawa ..... D9/504
5,562,960	A	10/1996	Sugiura et al.	D477,536	S *	7/2003	Kudo et al. .... D9/522
5,564,596	A	10/1996	Meadows et al.	2001/0009990	A1	7/2001	Hostettler et al.
5,565,160	A	10/1996	Makuuchi et al.	2002/0071708	A1	6/2002	Fontanet et al.
5,582,330	A	12/1996	Iba				
5,582,598	A	12/1996	Chanoch				
5,591,136	A	1/1997	Gabriel				
5,609,273	A	3/1997	Firestone et al.				

FOREIGN PATENT DOCUMENTS

EP	0649795	B1	6/1999	.....	47/20
EP	0673852	B1	2/2000	.....	47/20

\* cited by examiner

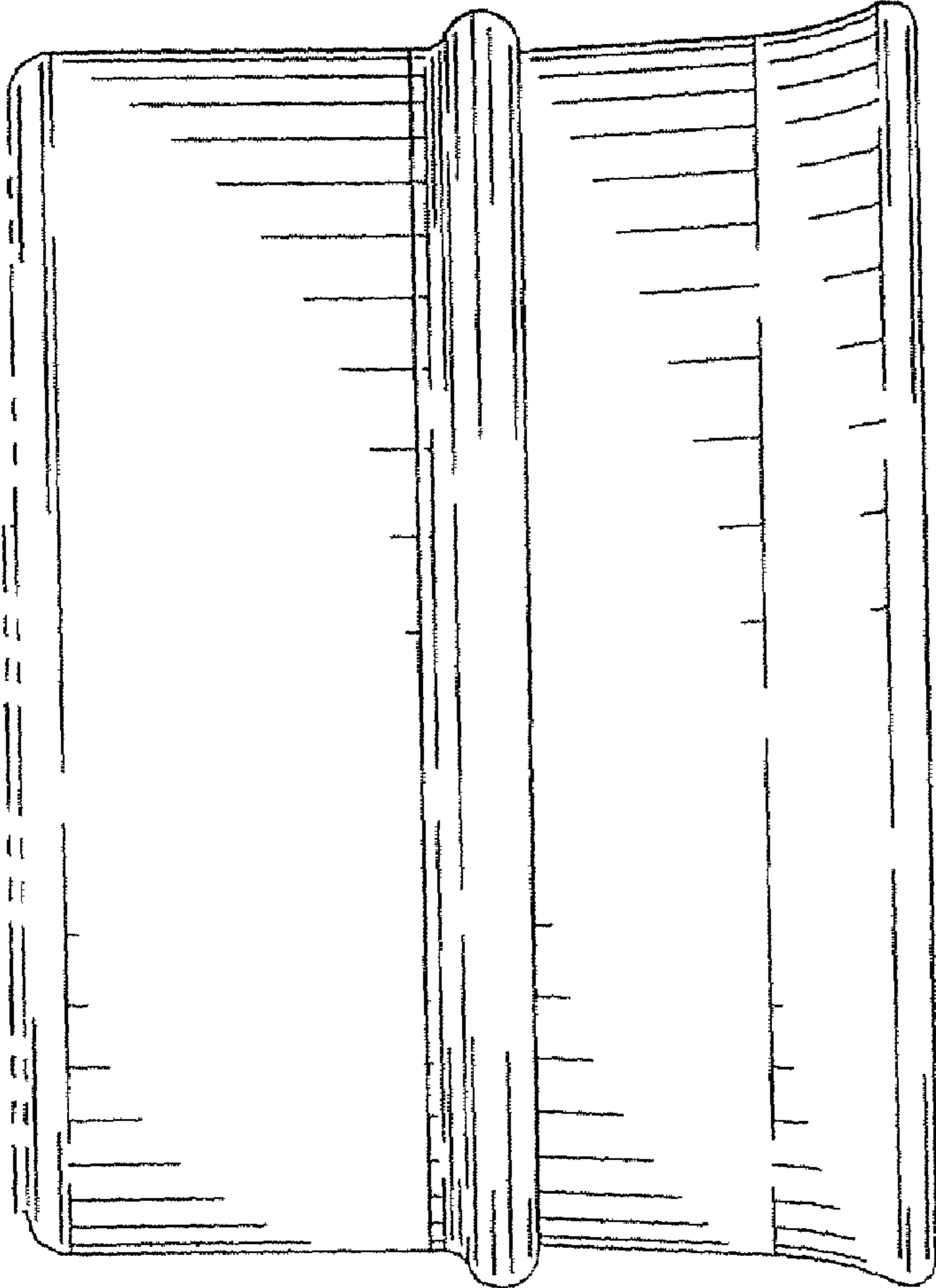

FIG. 1



FIG. 2

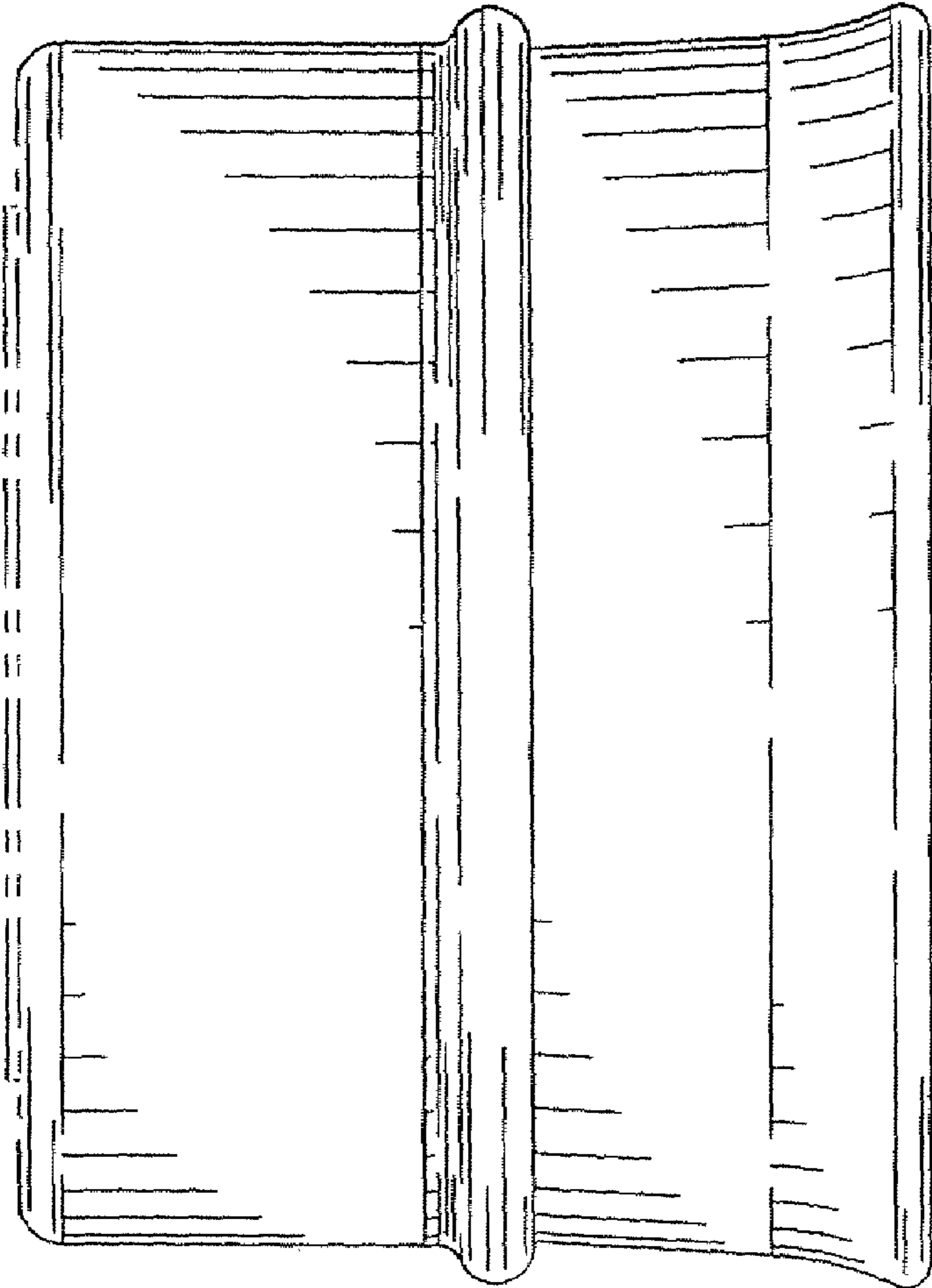

FIG. 3

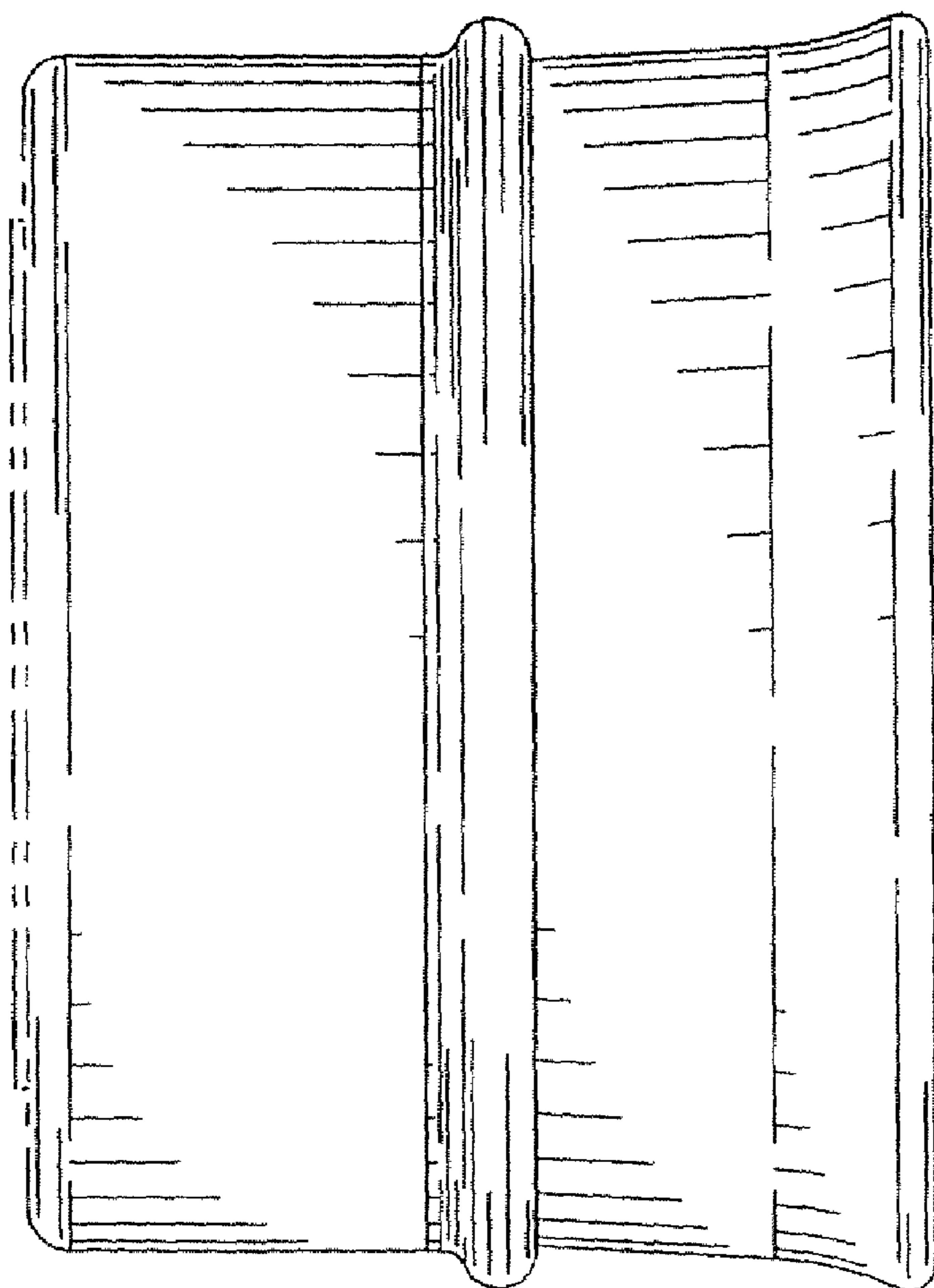

FIG. 4

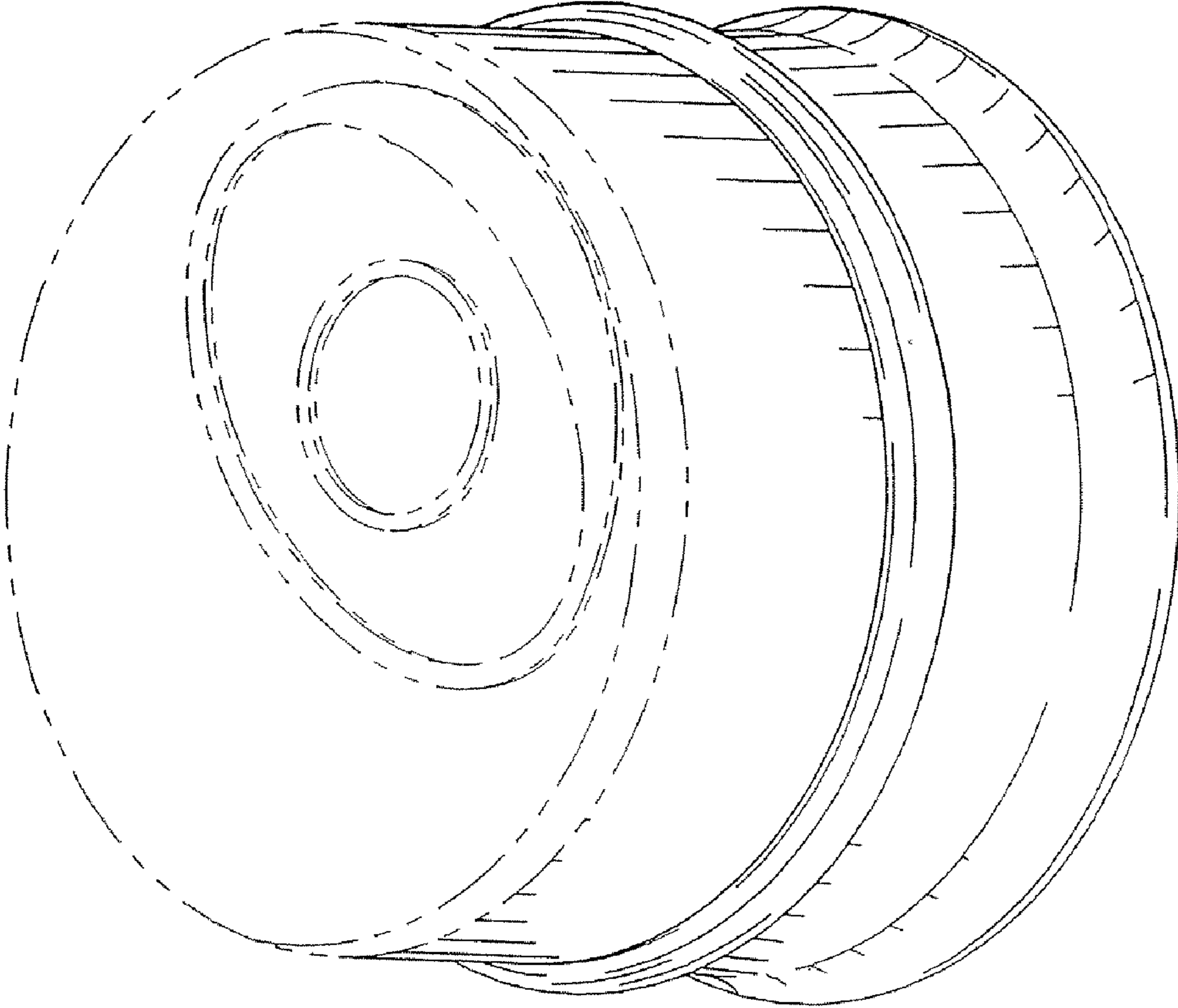

FIG. 5

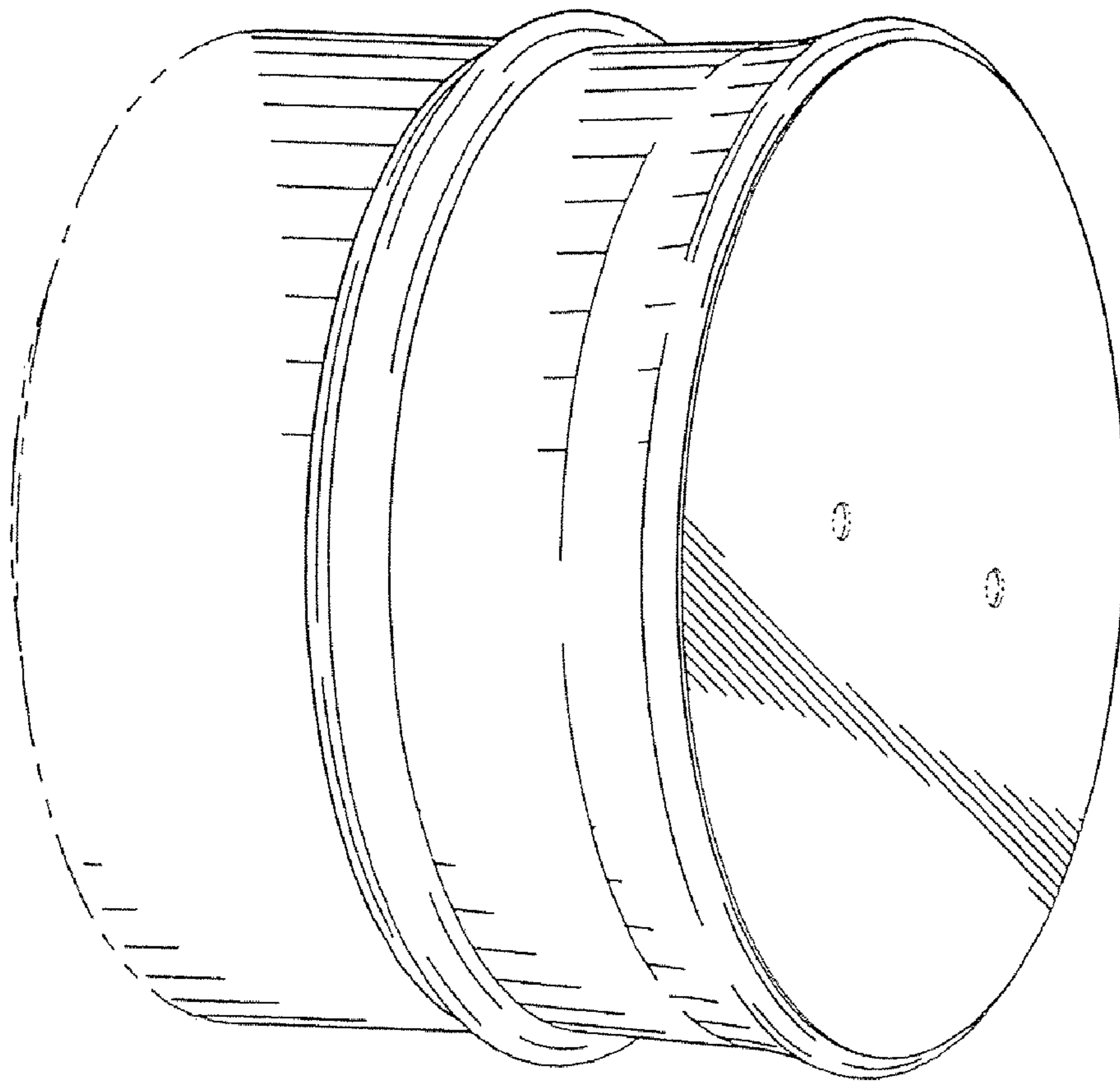

FIG. 6



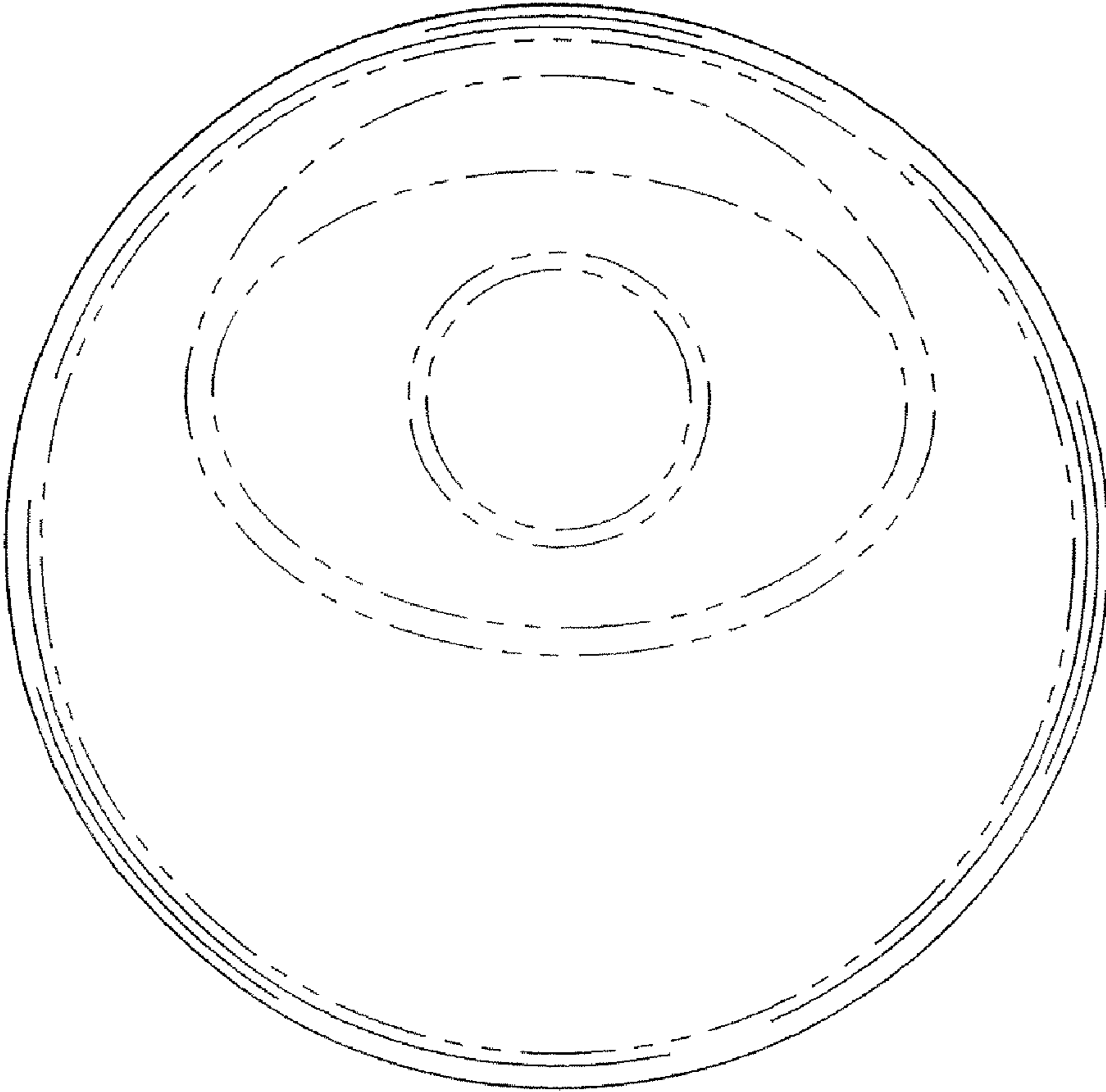

FIG. 7

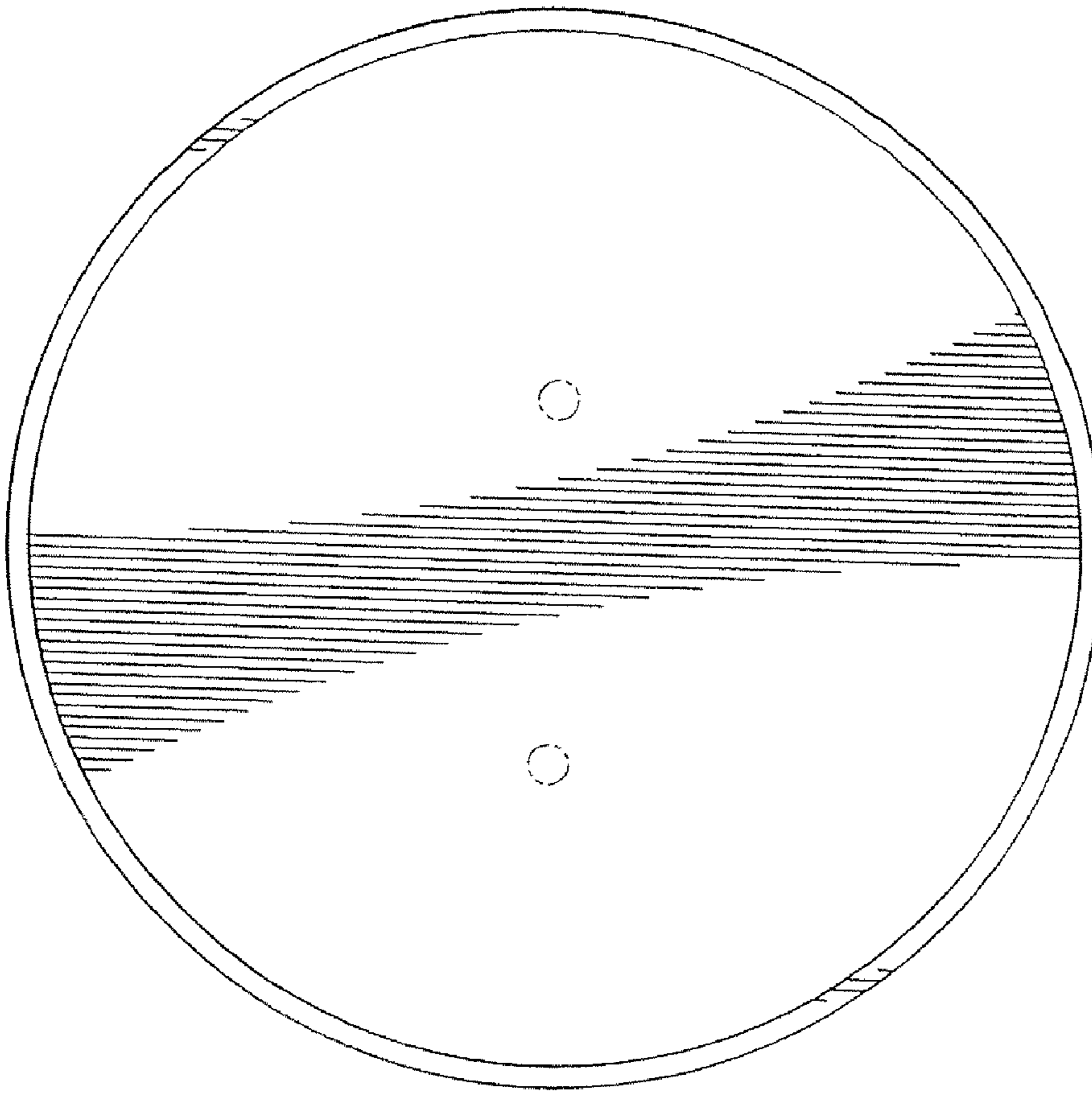

FIG. 8