



US00D572780S

(12) **United States Design Patent**
Rollinson

(10) **Patent No.:** **US D572,780 S**
(45) **Date of Patent:** **** Jul. 8, 2008**

(54) **PUTTER HEAD**

(75) Inventor: **Augustin W. Rollinson**, Carlsbad, CA
(US)

(73) Assignee: **Callaway Golf Company**, Carlsbad, CA
(US)

(**) Term: **14 Years**

(21) Appl. No.: **29/279,441**

(22) Filed: **May 1, 2007**

(51) **LOC (8) Cl.** **21-02**

(52) **U.S. Cl.** **D21/744**

(58) **Field of Classification Search** D21/736-746;
473/324-331, 340-341, 251-256
See application file for complete search history.

(56) **References Cited**

U.S. PATENT DOCUMENTS

D457,586 S *	5/2002	Tang et al.	D21/759
D461,515 S *	8/2002	Tang et al.	D21/742
D467,985 S *	12/2002	Tang et al.	D21/742
D483,824 S *	12/2003	Tang et al.	D21/738
D485,323 S *	1/2004	Wagner et al.	D21/744
D496,418 S *	9/2004	Tang et al.	D21/738

D518,127 S *	3/2006	Tang et al.	D21/742
D537,135 S *	2/2007	Rollinson et al.	D21/742
D539,865 S *	4/2007	Tang et al.	D21/759
D545,385 S *	6/2007	Tang et al.	D21/736

* cited by examiner

Primary Examiner—Mitchell I Siegel

(74) *Attorney, Agent, or Firm*—Michael A. Catania; Elaine H. Lo

(57) **CLAIM**

The ornamental design for a putter head, as shown and described.

DESCRIPTION

FIG. 1 is a top perspective view of a putter head as claimed herein;

FIG. 2 is a front elevational view thereof;

FIG. 3 is a rear elevational view thereof;

FIG. 4 is a toe elevational view thereof;

FIG. 5 is a heel elevational view thereof

FIG. 6 is a top plan view thereof; and,

FIG. 7 is a bottom plan view thereof.

1 Claim, 2 Drawing Sheets

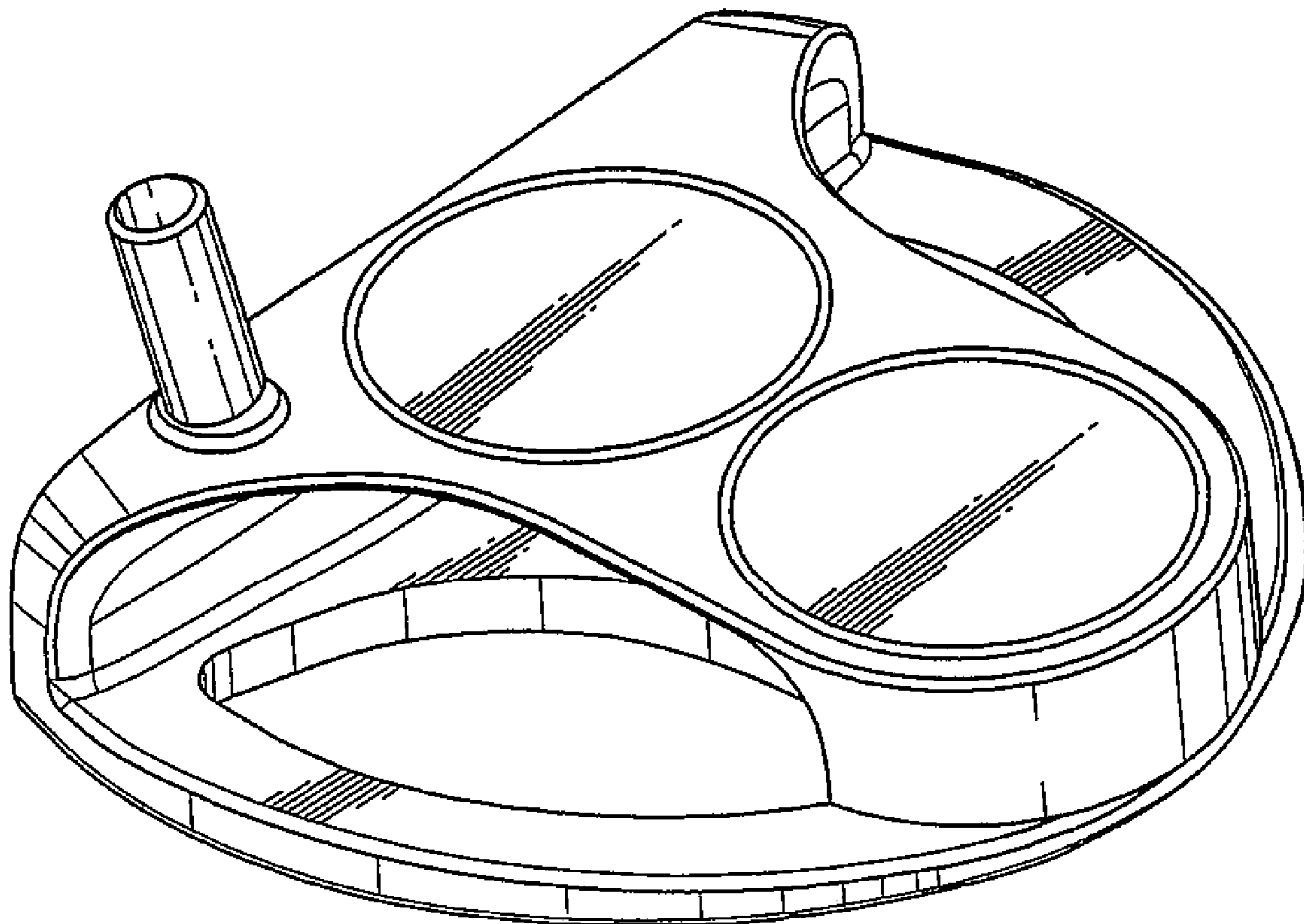

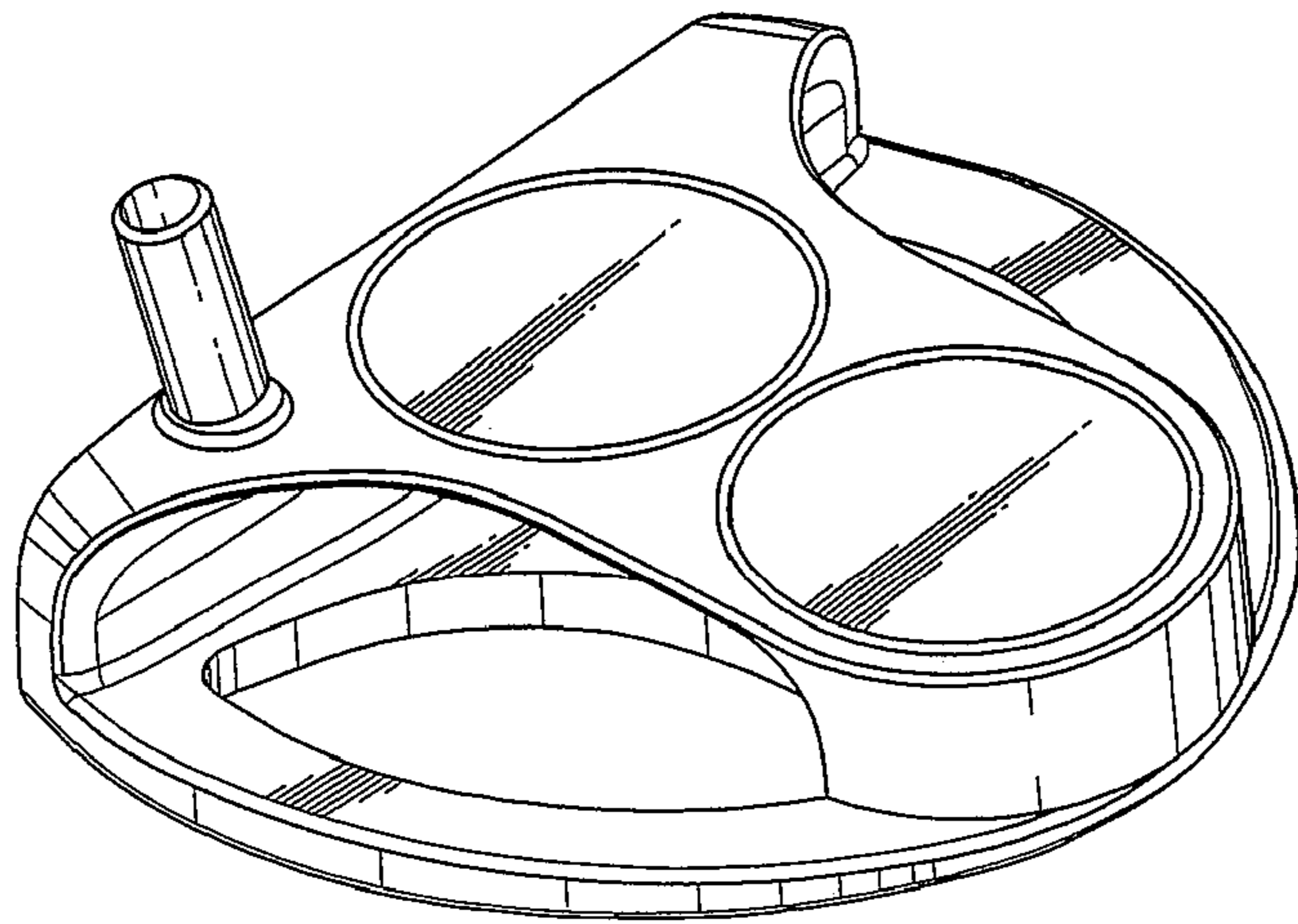

FIG. 1

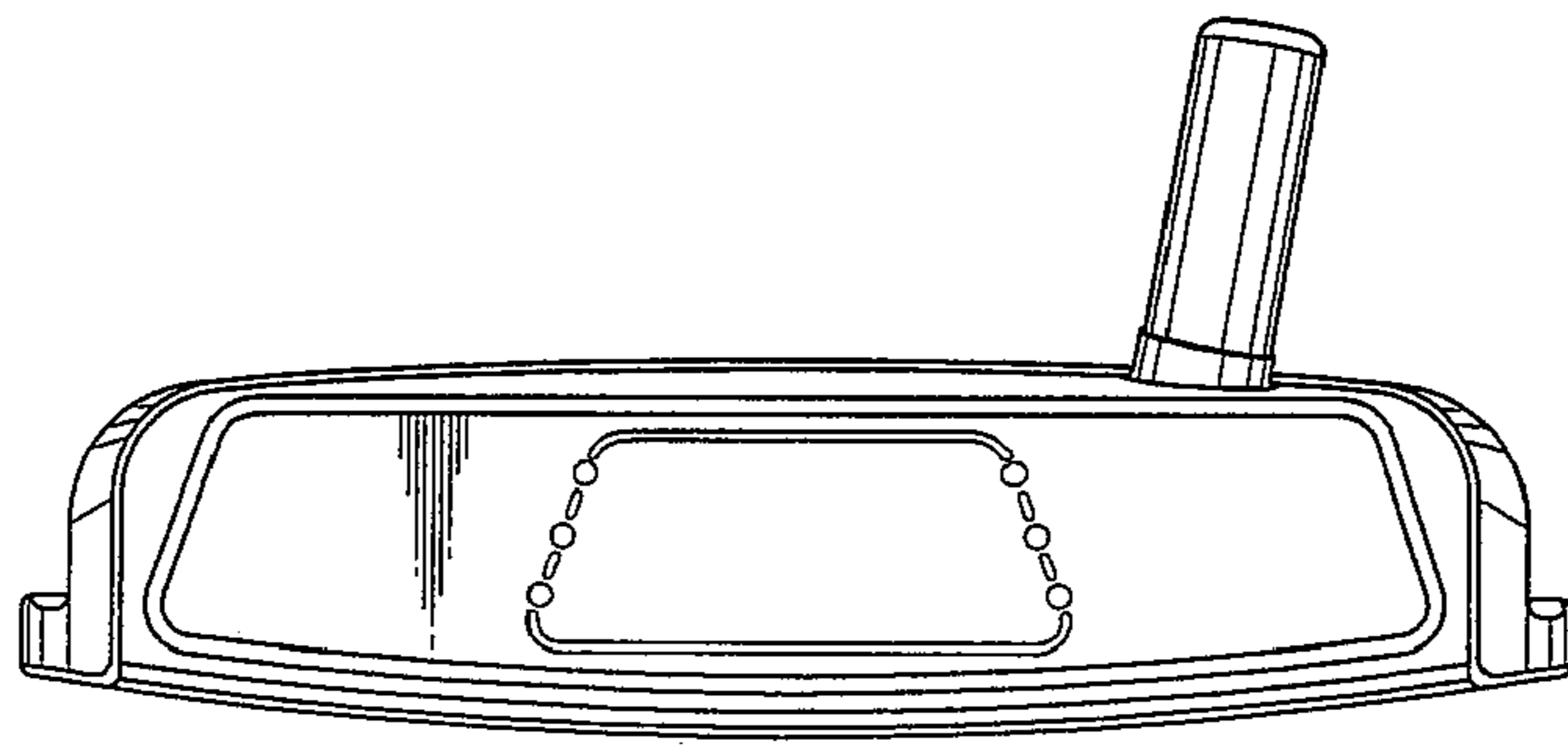

FIG. 2

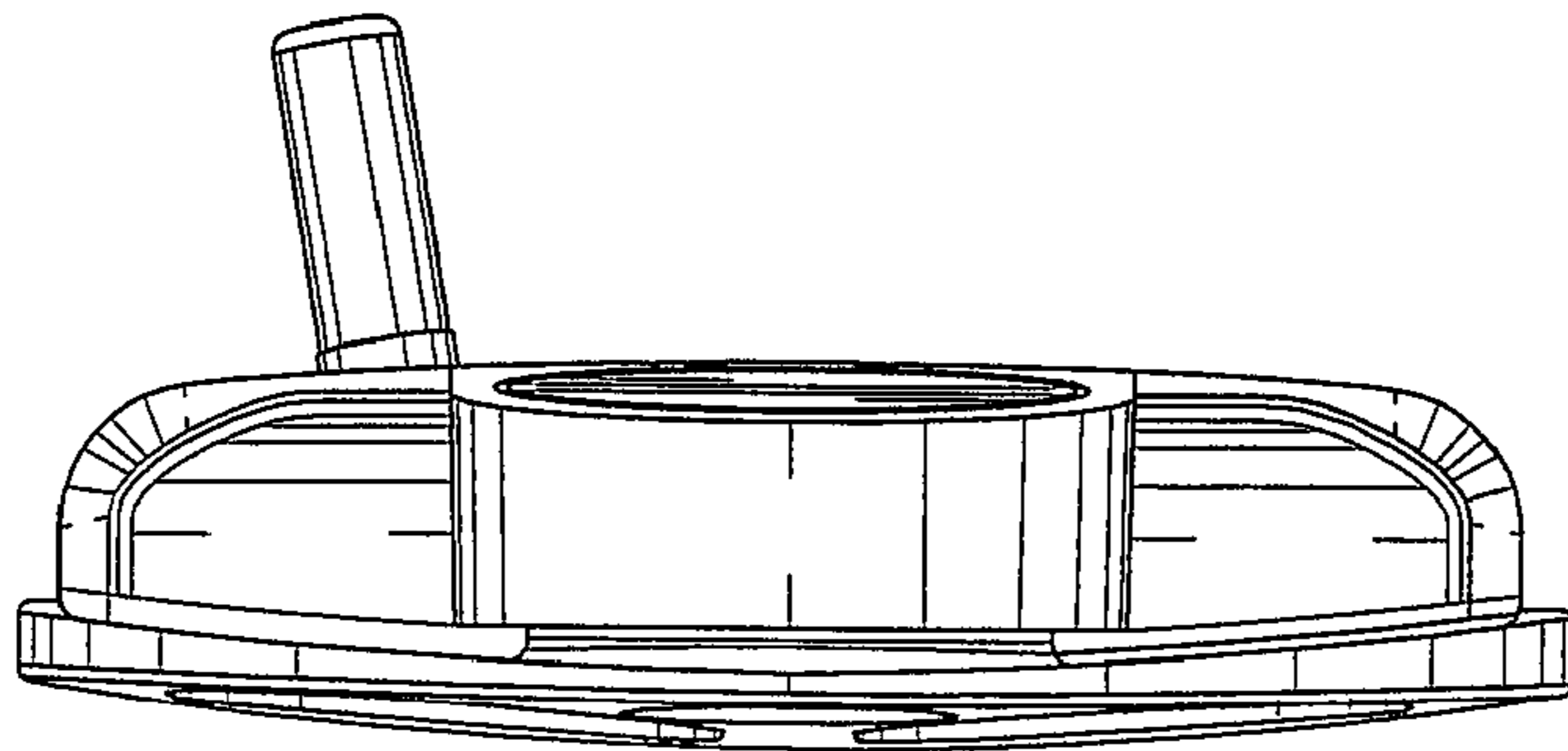

FIG. 3

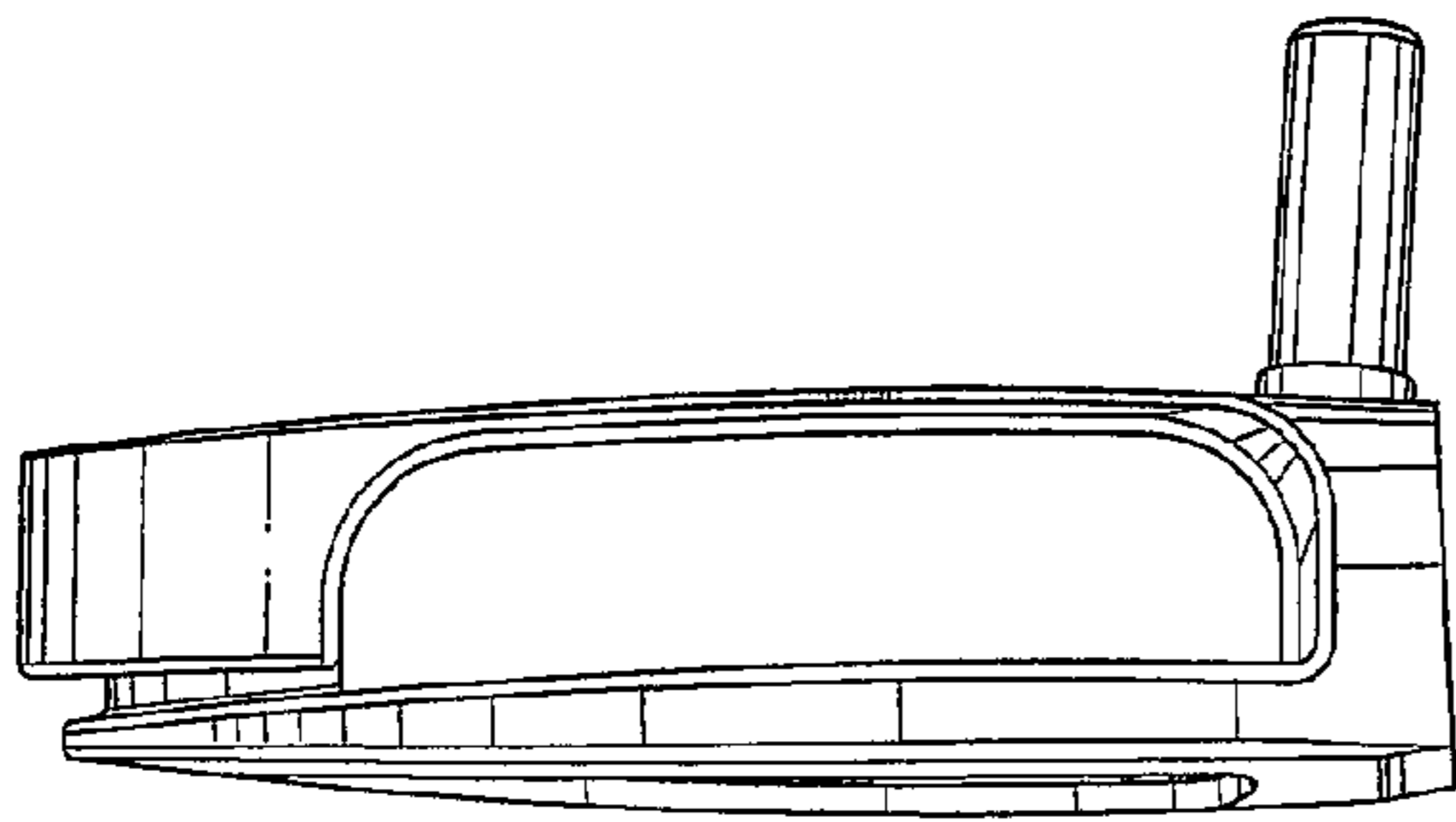

FIG. 4

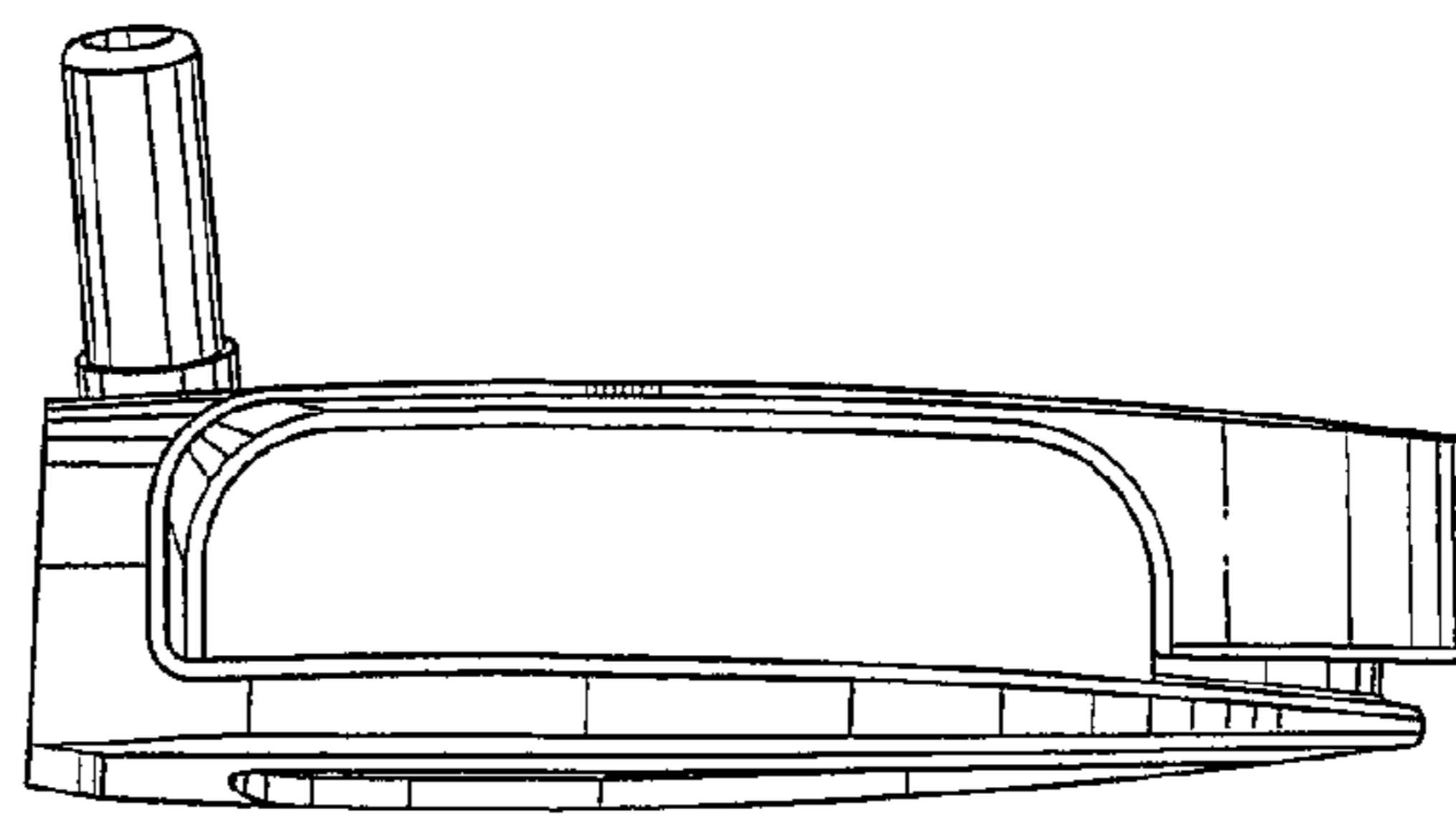

FIG. 5

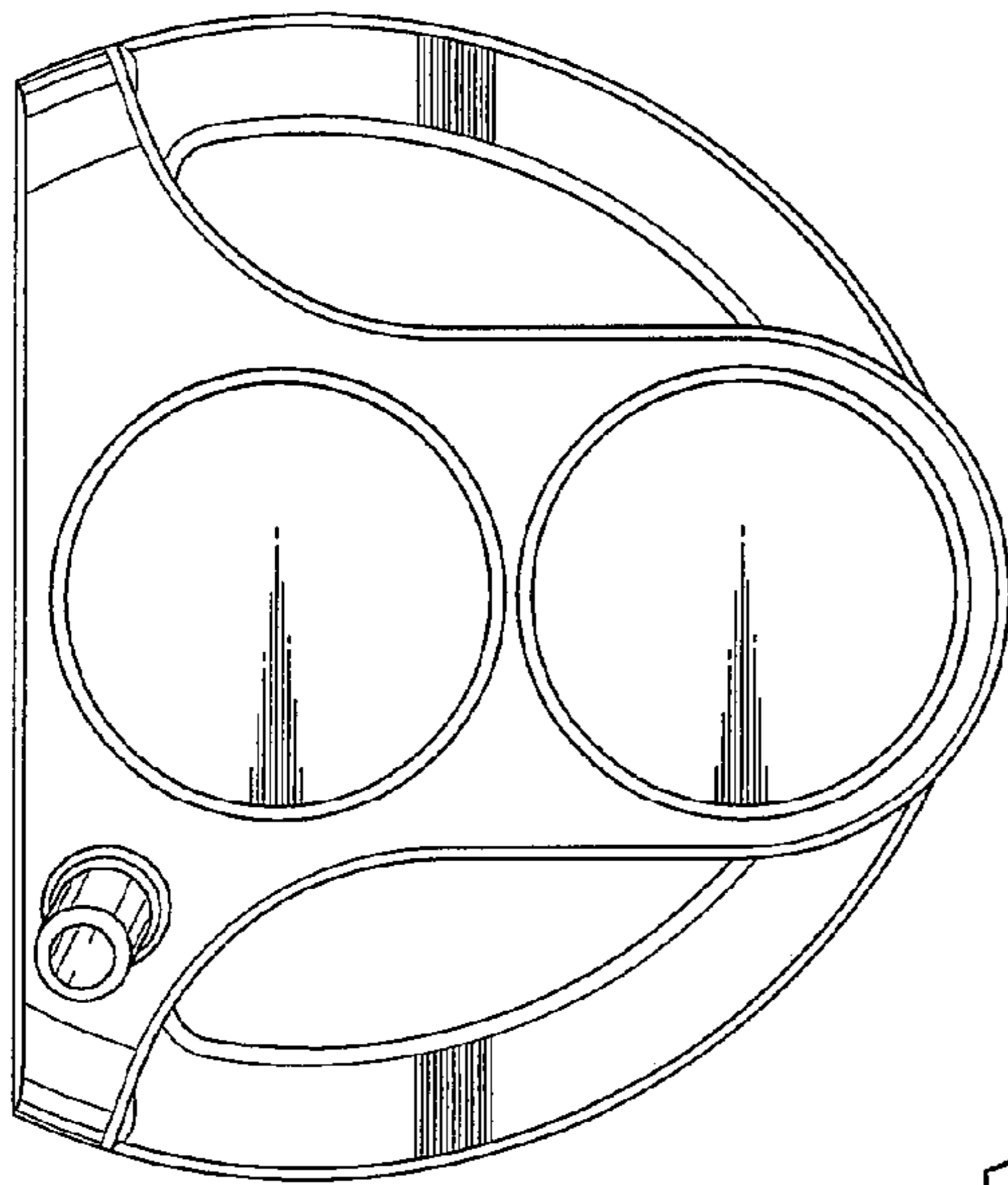

FIG. 6

FIG. 7

