



US00D572610S

(12) **United States Design Patent**  
**Colombo**

(10) **Patent No.:** **US D572,610 S**  
(45) **Date of Patent:** **\*\* Jul. 8, 2008**

(54) **WRIST WATCH**

(76) Inventor: **Marco Colombo**, Via Tevere, 7, Lainate  
(Milano) (IT) I-20020

(\*) Notice: This patent is subject to a terminal disclaimer.

(\*\*) Term: **14 Years**

(21) Appl. No.: **29/250,087**

(22) Filed: **Nov. 1, 2006**

(30) **Foreign Application Priority Data**

May 2, 2006 (IT) ..... MI2006O000090

(51) **LOC (8) Cl.** ..... **10-02**

(52) **U.S. Cl.** ..... **D10/39**

(58) **Field of Classification Search** ..... D10/30-39,  
D10/123-126; 368/276, 278, 281, 282, 285,  
368/223, 21, 28, 228, 232

See application file for complete search history.

(56) **References Cited**

**U.S. PATENT DOCUMENTS**

2,535,543 A \* 12/1950 Maizlish et al. .... 368/27  
4,706,857 A \* 11/1987 Aellen et al. .... 224/164  
4,742,503 A \* 5/1988 Braun et al. .... 368/282  
D299,117 S \* 12/1988 Maroni ..... D10/32  
4,855,973 A \* 8/1989 Crocco ..... 368/282

4,964,092 A \* 10/1990 Brida ..... 368/282  
D362,396 S \* 9/1995 Chester ..... D10/32  
D433,949 S \* 11/2000 Helleu ..... D10/30  
D470,778 S \* 2/2003 Berke ..... D10/32  
6,690,623 B1 \* 2/2004 Maano ..... 368/82  
D505,086 S \* 5/2005 Fernandez ..... D10/39  
D520,380 S \* 5/2006 Correia ..... D10/31  
7,083,326 B2 \* 8/2006 Ast et al. .... 368/296

\* cited by examiner

*Primary Examiner*—Lucy Lieberman

(74) *Attorney, Agent, or Firm*—Shoemaker and Mattare

(57) **CLAIM**

The ornamental design for a wrist watch, as shown and described.

**DESCRIPTION**

FIG. 1 is a front perspective view of a wrist watch, showing my new design;

FIG. 2 is a rear perspective view thereof;

FIG. 3 is a front elevational view thereof;

FIG. 4 is a left side elevation of the wrist watch, the right side elevation being the same;

FIG. 5 is a top plan view of the wrist watch, the bottom plan view being the same; and,

FIG. 6 is a rear elevational view thereof.

**1 Claim, 6 Drawing Sheets**

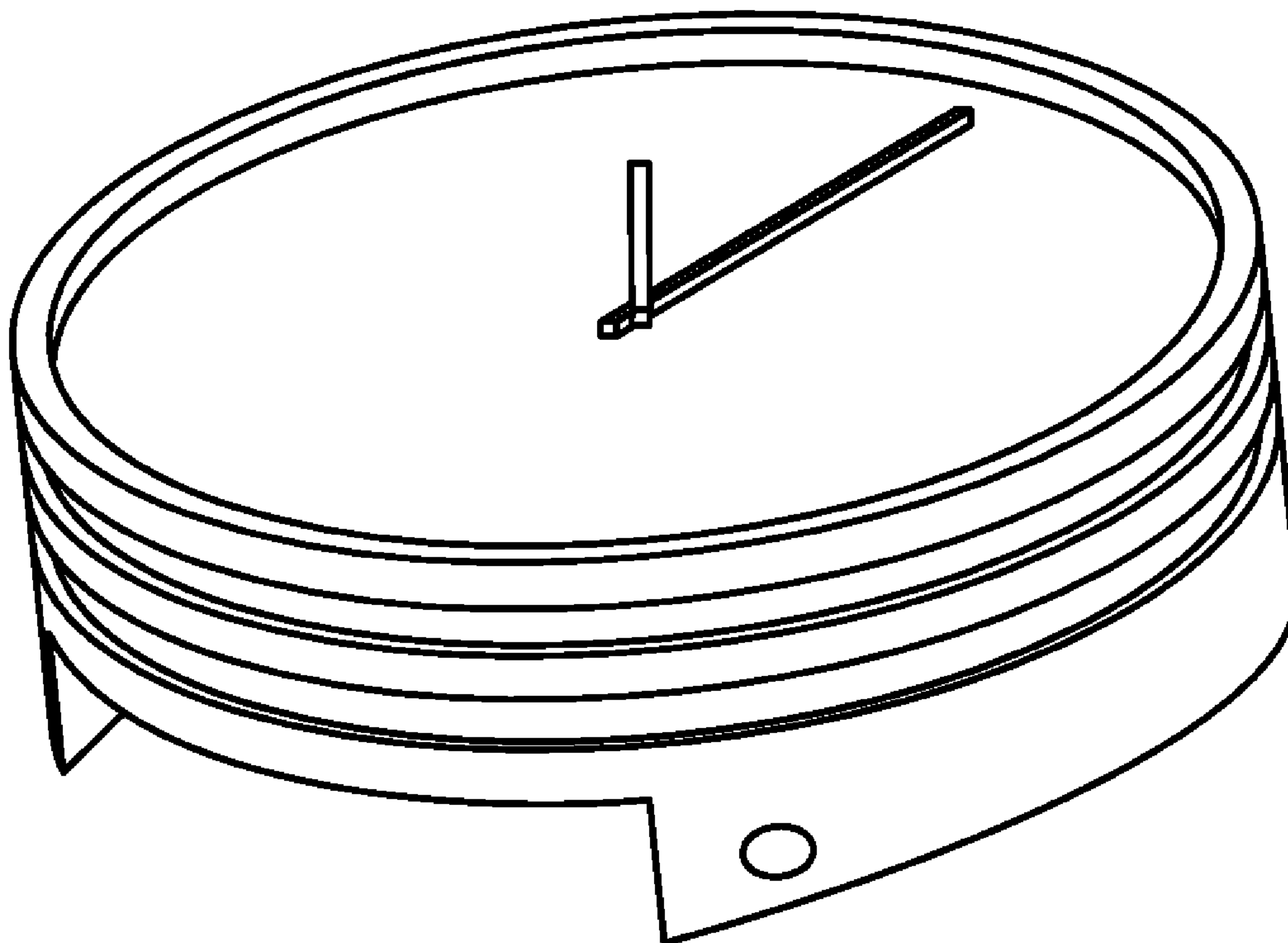

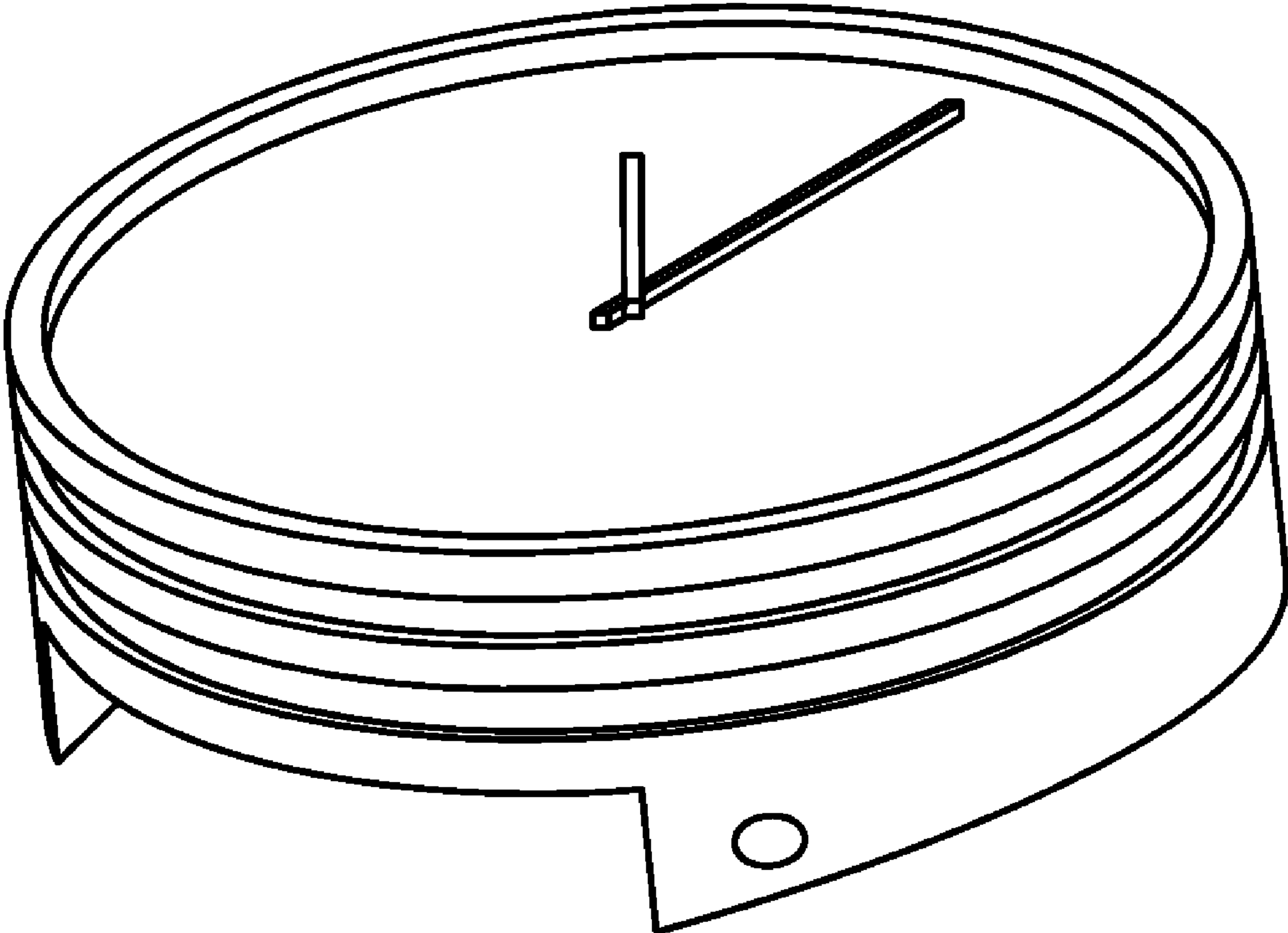

FIG. 1

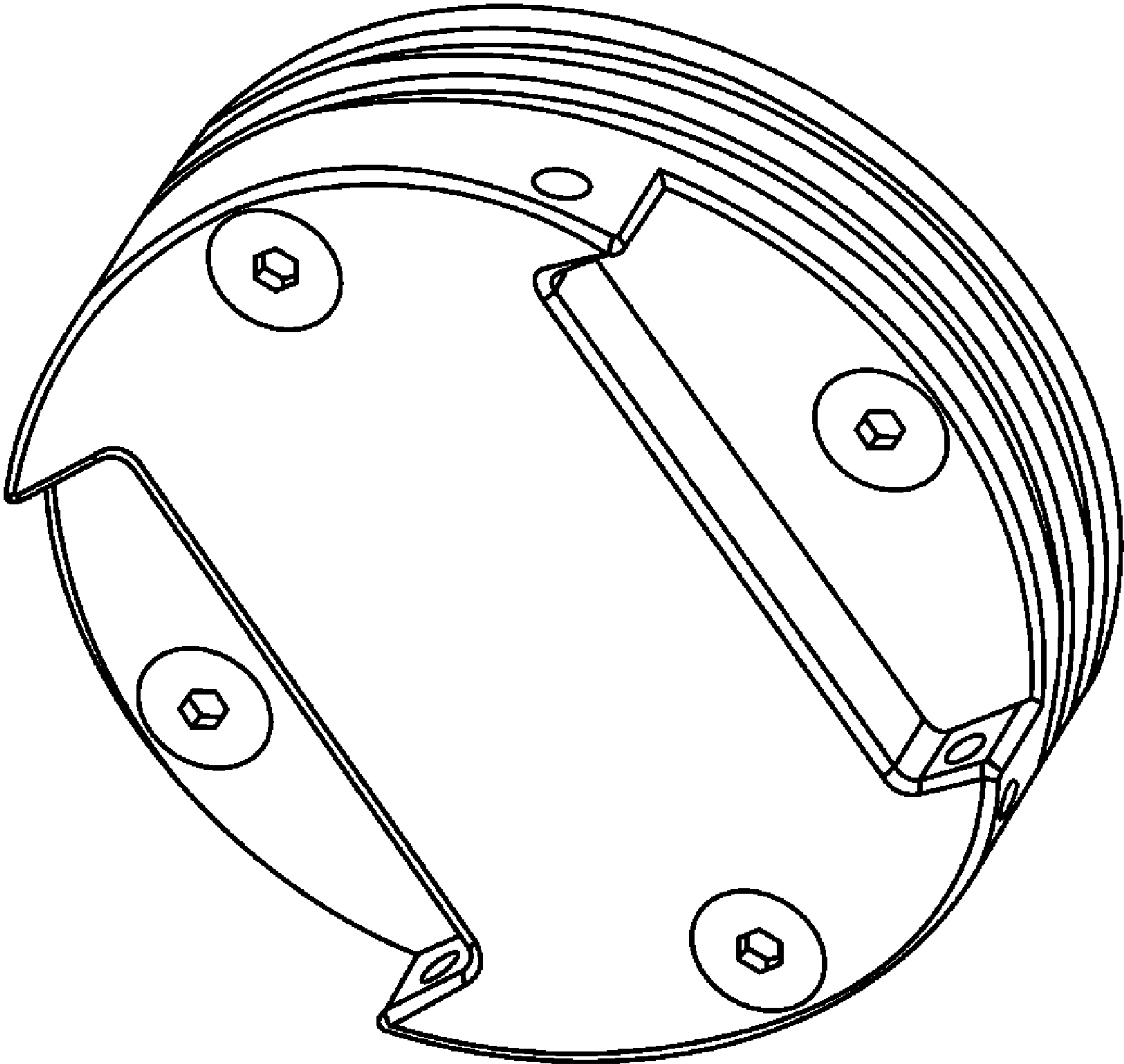
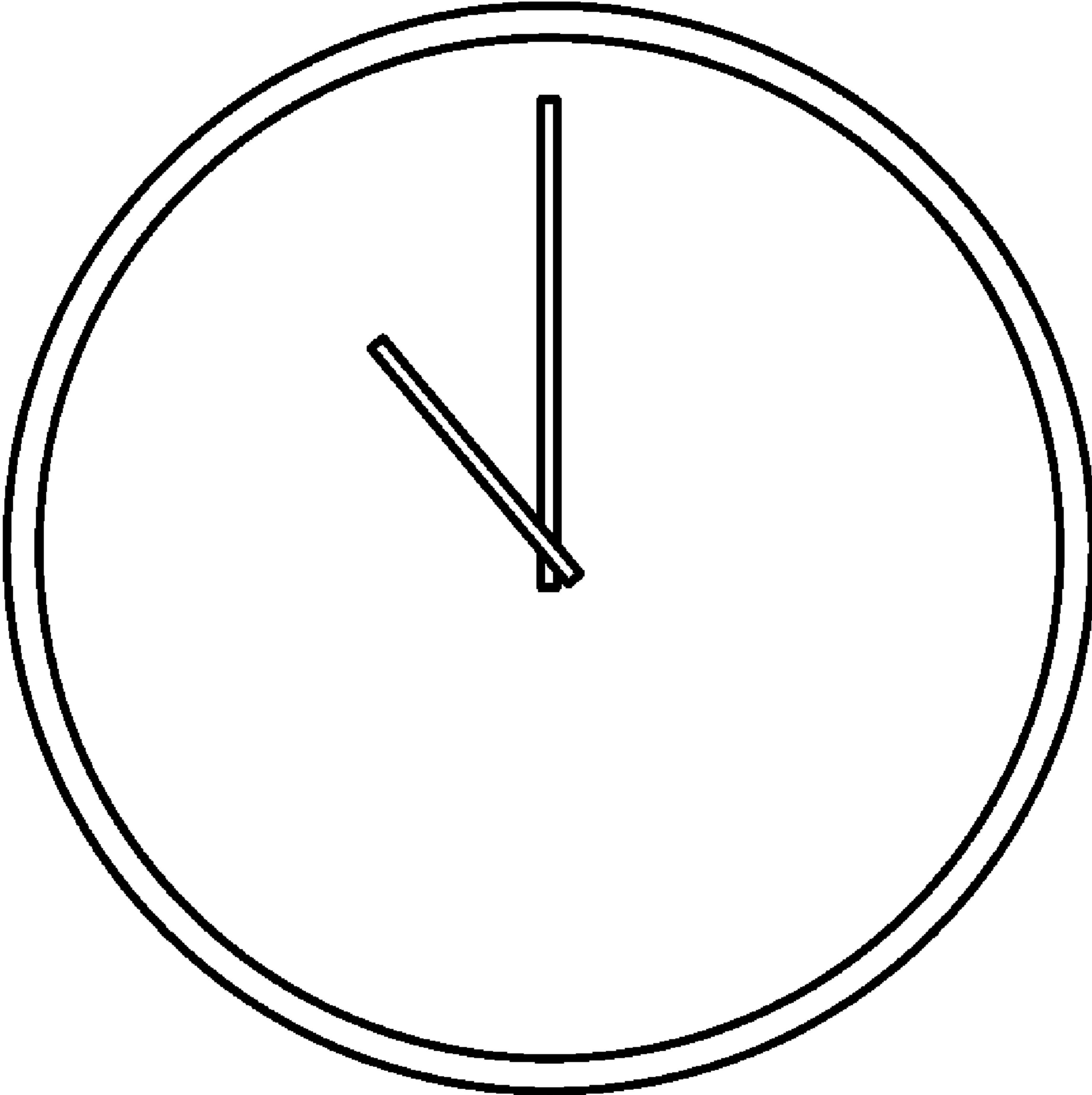
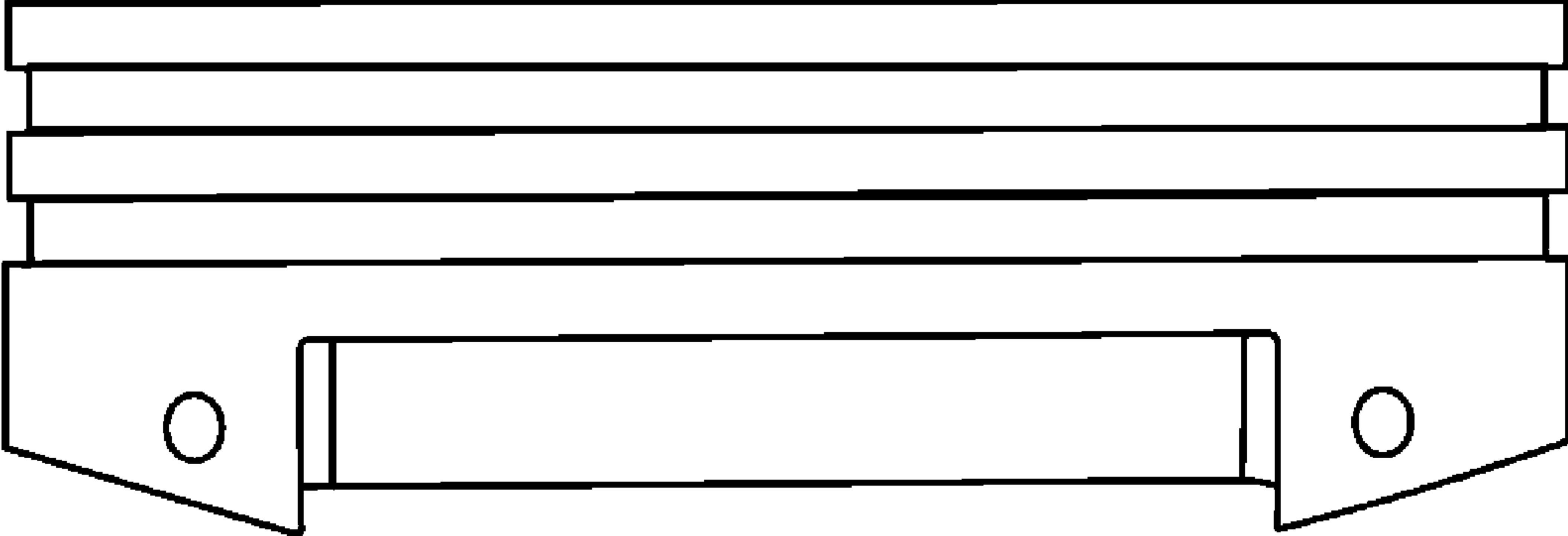

FIG. 2



**FIG. 3**



**FIG. 4**

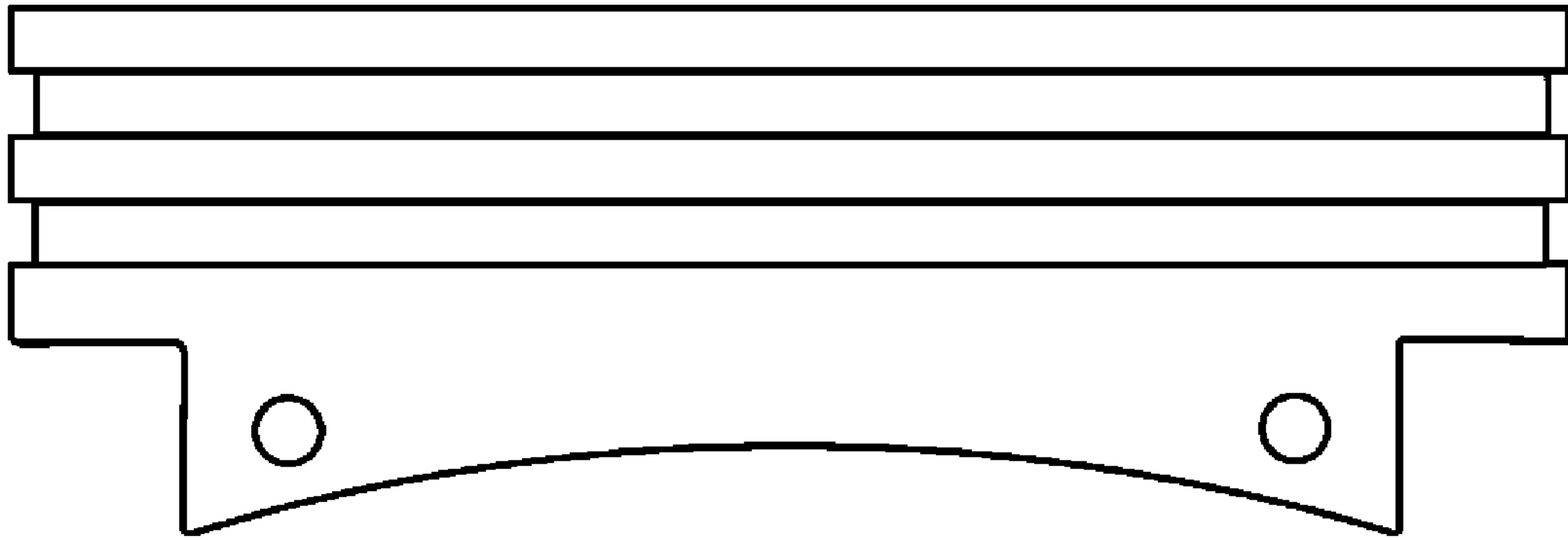

**FIG. 5**

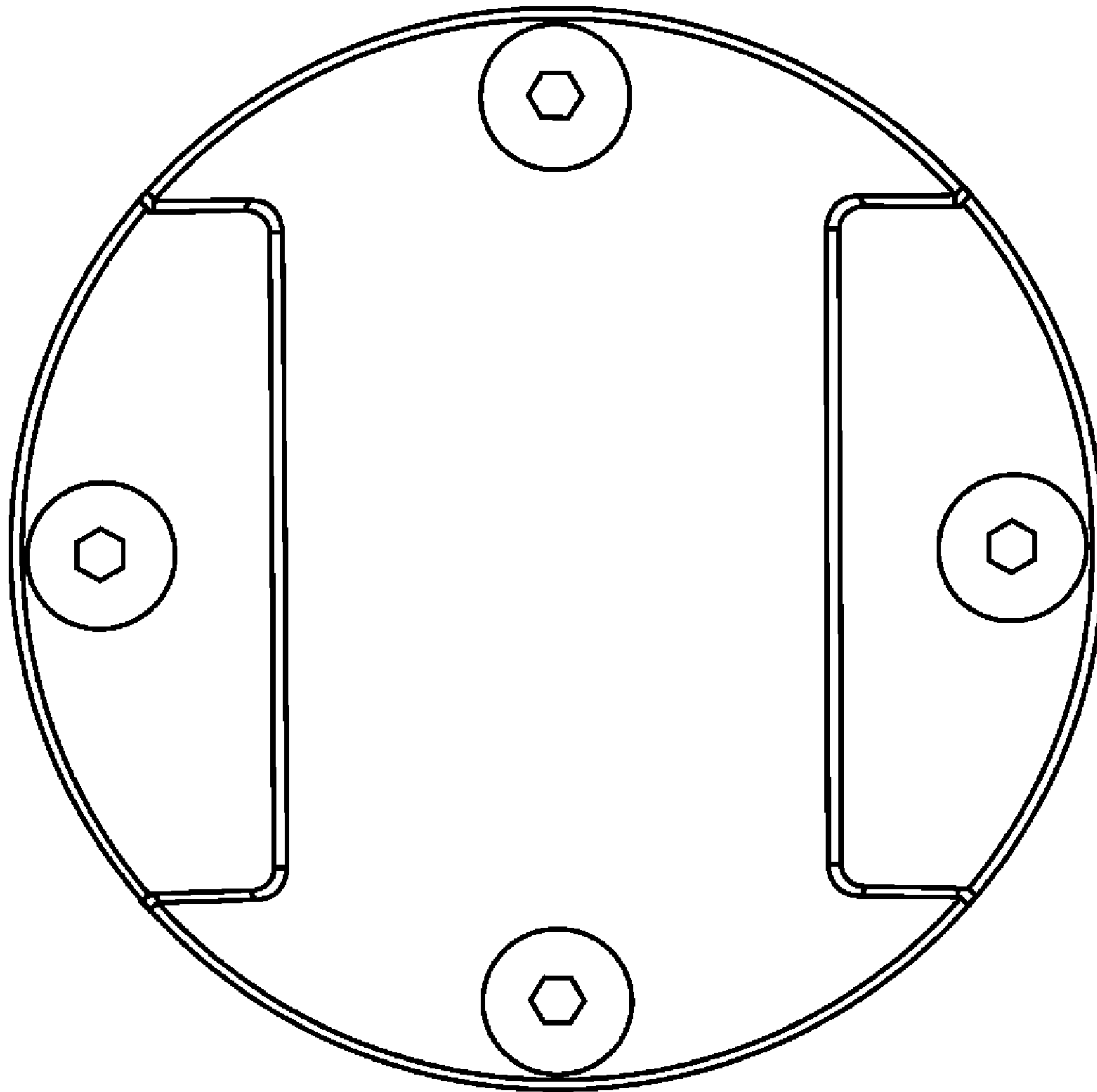

FIG. 6