



US00D572592S

(12) **United States Design Patent**  
**Chang**

(10) **Patent No.:** **US D572,592 S**

(45) **Date of Patent:** **\*\* Jul. 8, 2008**

(54) **CONTAINER**

(76) **Inventor:** **Chia-Sheng Chang**, No. 52, Feng Chang St., Nan Tun District, Taichung City (TW)

(\*\*) **Term:** **14 Years**

(21) **Appl. No.:** **29/276,527**

(22) **Filed:** **Jan. 29, 2007**

(51) **LOC (8) Cl.** ..... **09-01**

(52) **U.S. Cl.** ..... **D9/504; D9/454**

(58) **Field of Classification Search** ..... D9/500, D9/502-504, 519, 529, 549, 557-558, 682, D9/686-691, 694, 900; D28/76, 78, 91, D28/91.1; 220/660-662, 669, 675; 215/379-383; D24/222-224

See application file for complete search history.

(56) **References Cited**

**U.S. PATENT DOCUMENTS**

- D389,279 S \* 1/1998 Ryder ..... D28/89
- D405,358 S \* 2/1999 Dapsanse ..... D9/663
- D459,553 S \* 6/2002 Bak ..... D28/85
- D484,644 S \* 12/2003 Noh ..... D28/76

- D485,017 S \* 1/2004 Noh ..... D28/76
- D486,393 S \* 2/2004 Chuang ..... D9/503
- D503,829 S \* 4/2005 Tanii et al. .... D28/76
- D503,830 S \* 4/2005 Tanii et al. .... D28/76
- D539,480 S \* 3/2007 Kostow ..... D28/76

\* cited by examiner

*Primary Examiner*—Ian Simmons

*Assistant Examiner*—Dana L Sipos

(74) *Attorney, Agent, or Firm*—Leong C. Lei

(57) **CLAIM**

The ornamental design for a container, as shown and described.

**DESCRIPTION**

FIG. 1 is a front perspective view of a container showing my new design;

FIG. 2 is a front elevational view thereof;

FIG. 3 is a rear elevational view thereof;

FIG. 4 is a left side elevational view thereof;

FIG. 5 is a right side elevational view thereof; and,

FIG. 6 is a top plan view thereof.

**1 Claim, 4 Drawing Sheets**

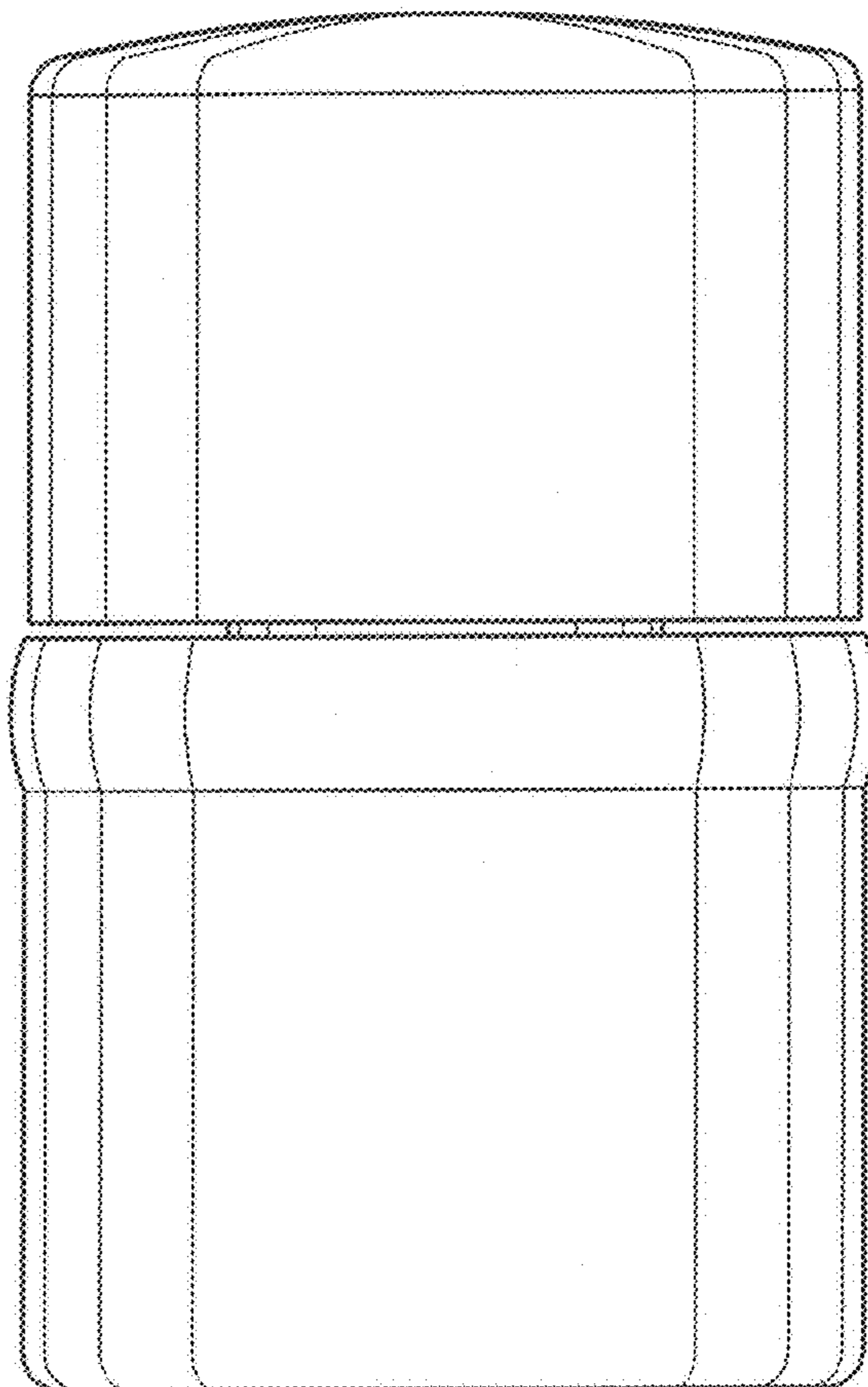

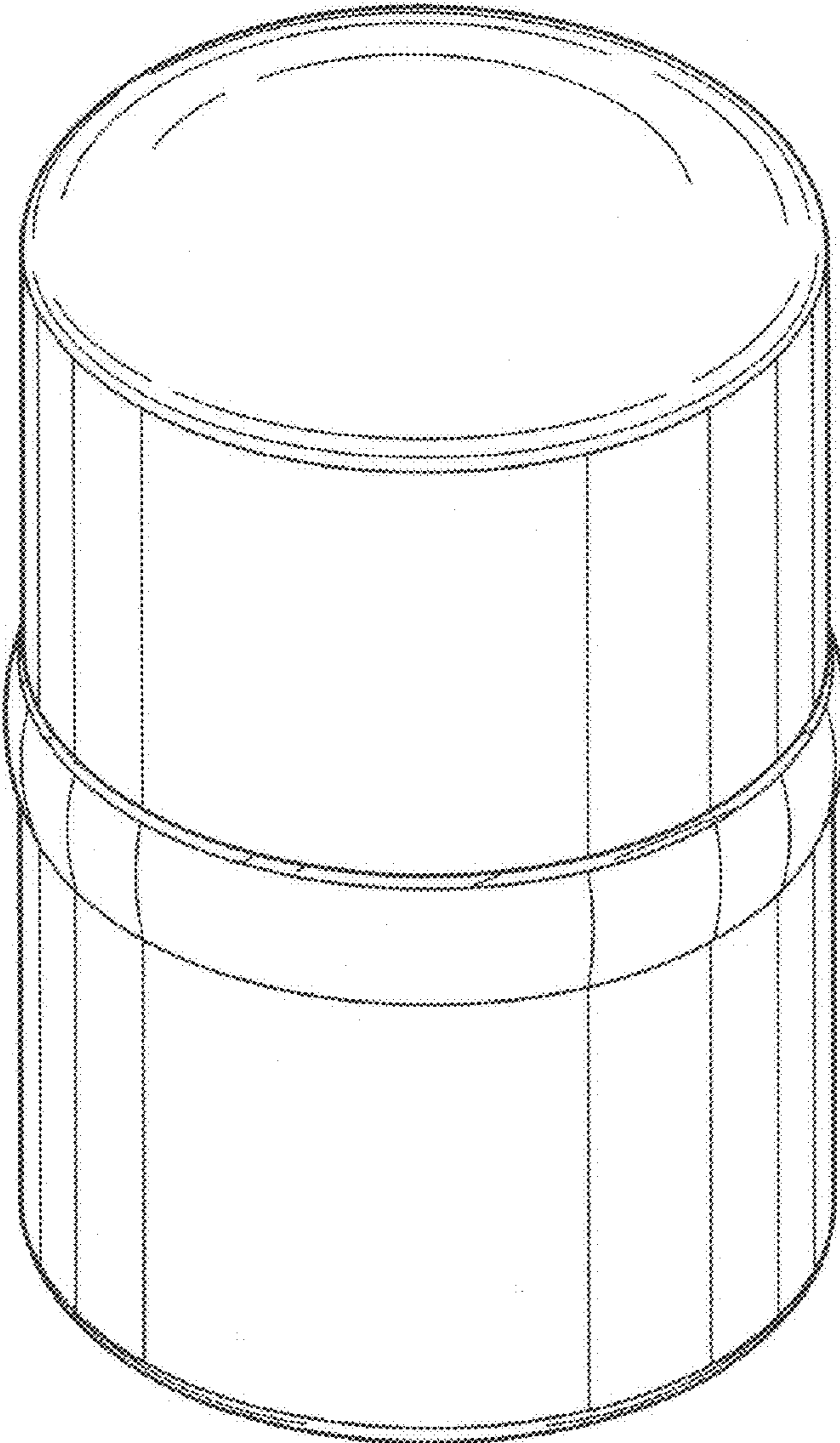

FIG. 1

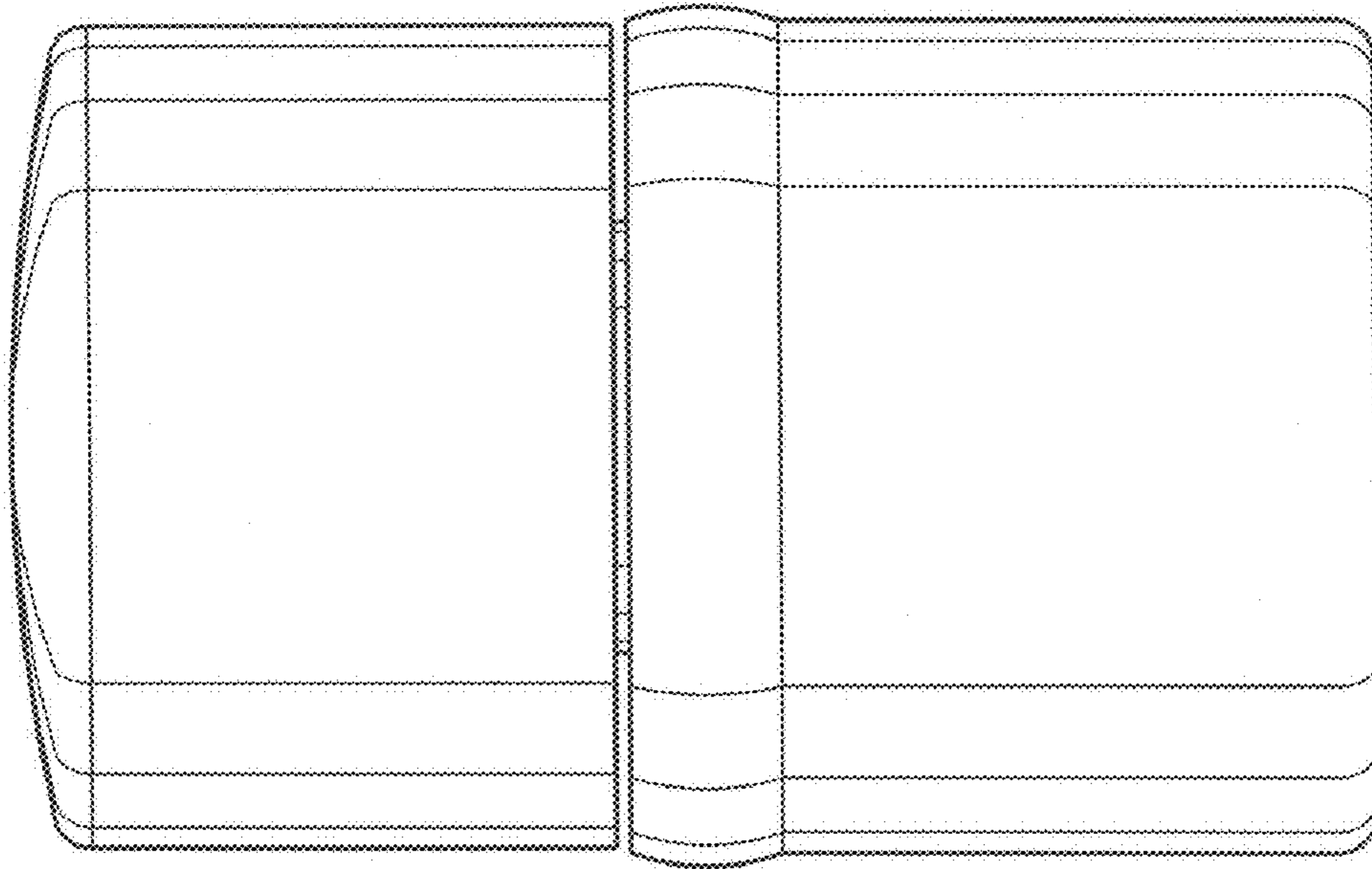

FIG. 3

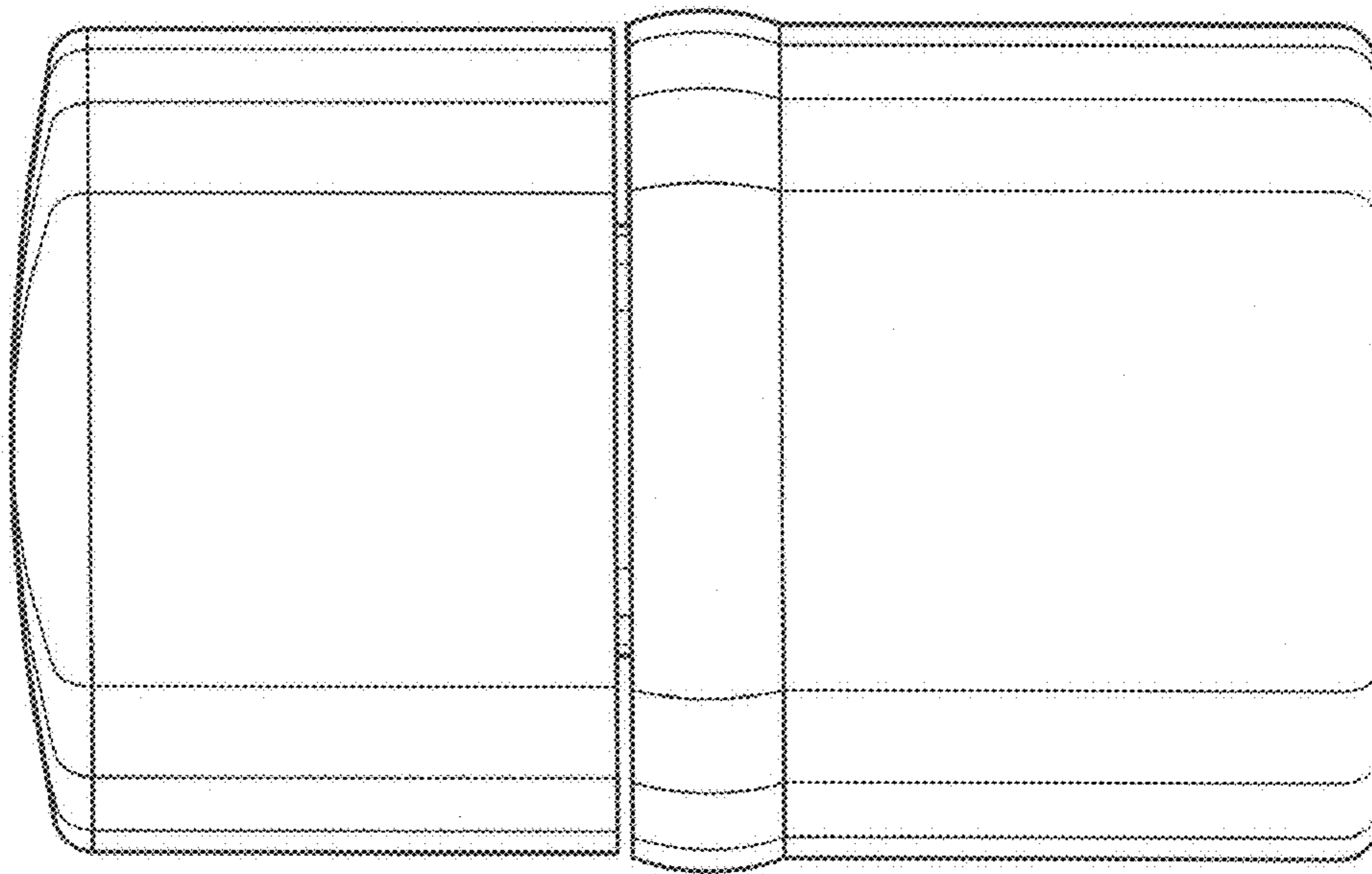

FIG. 2

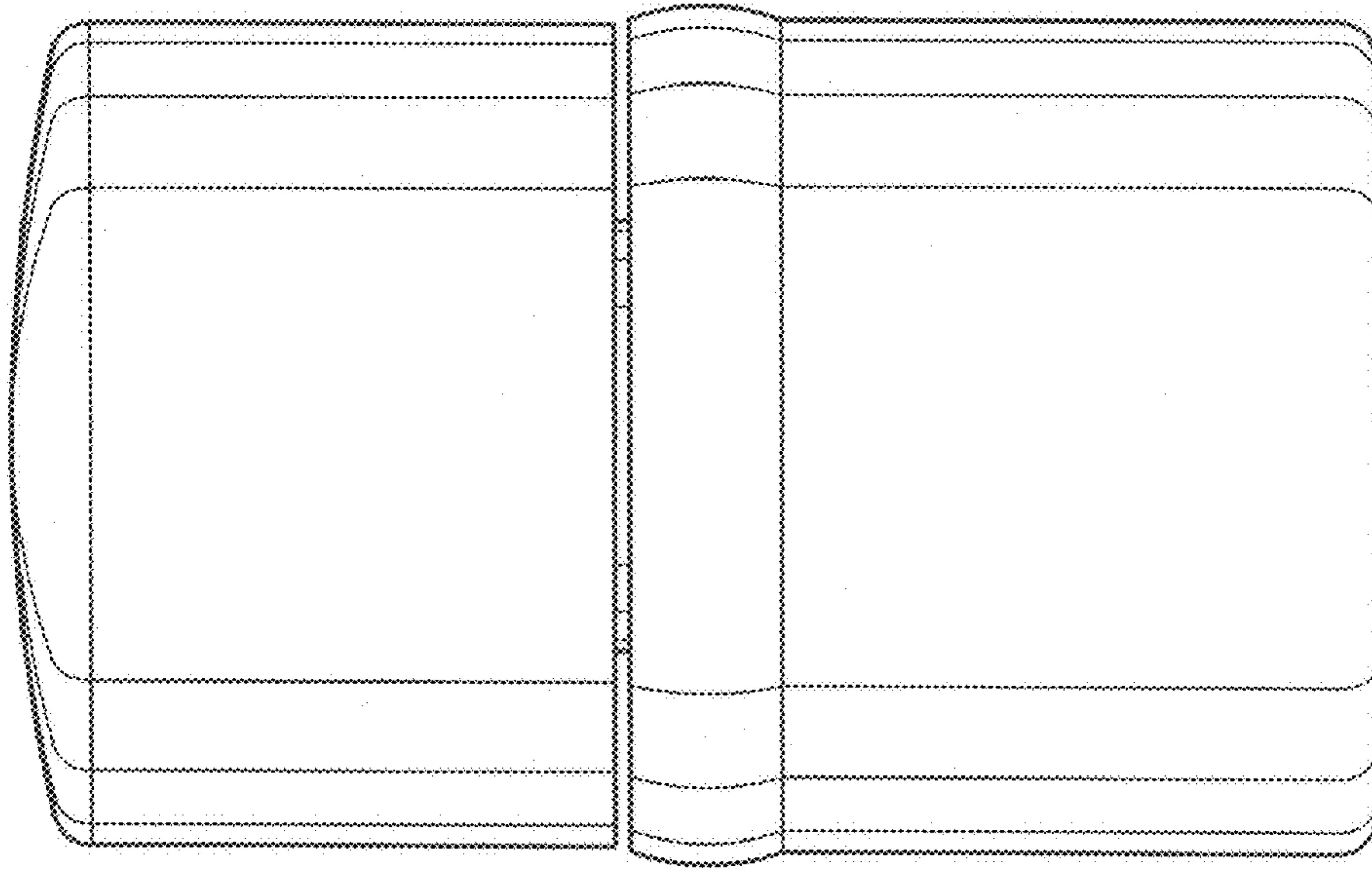

FIG. 5

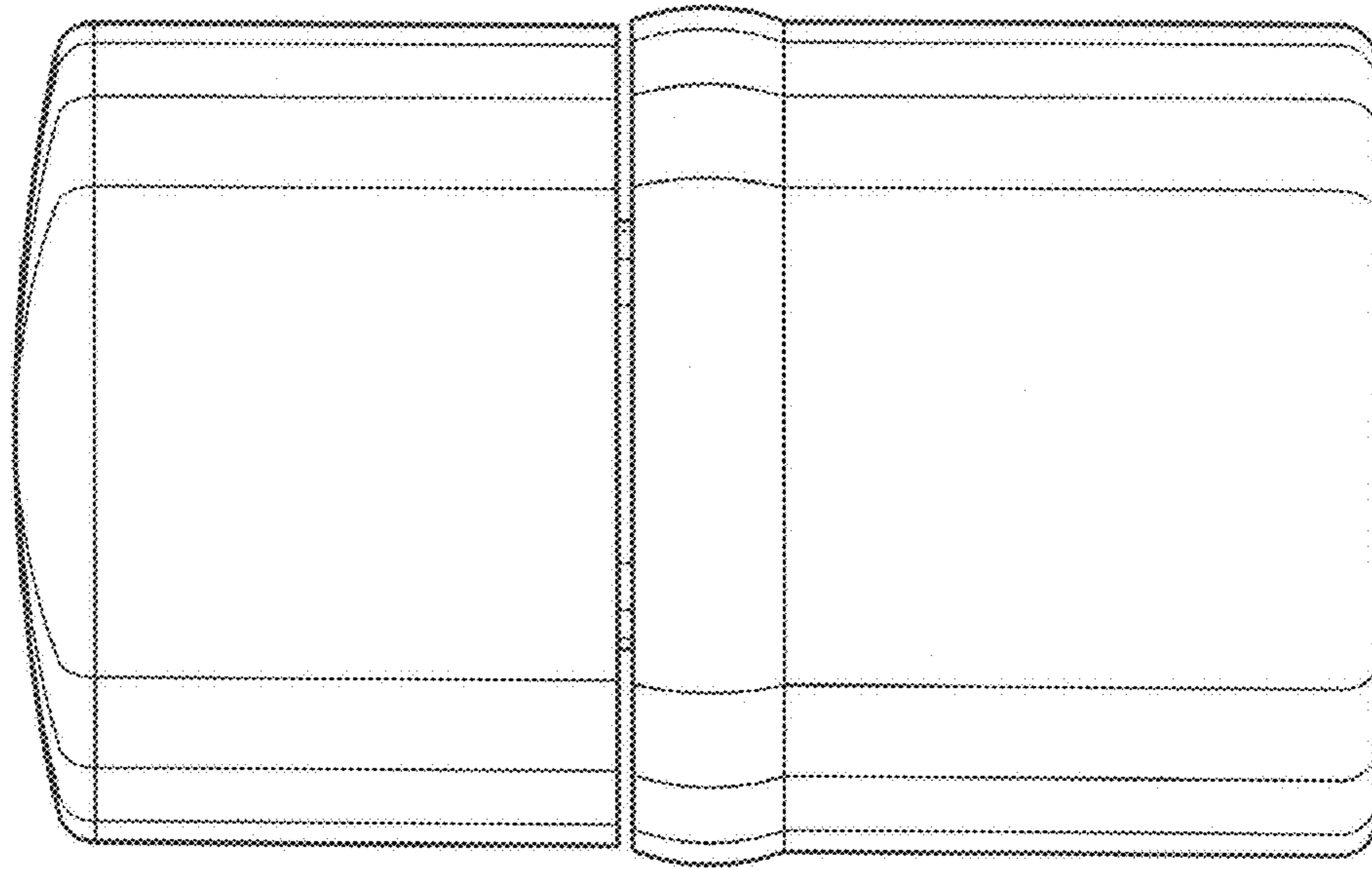

FIG. 4

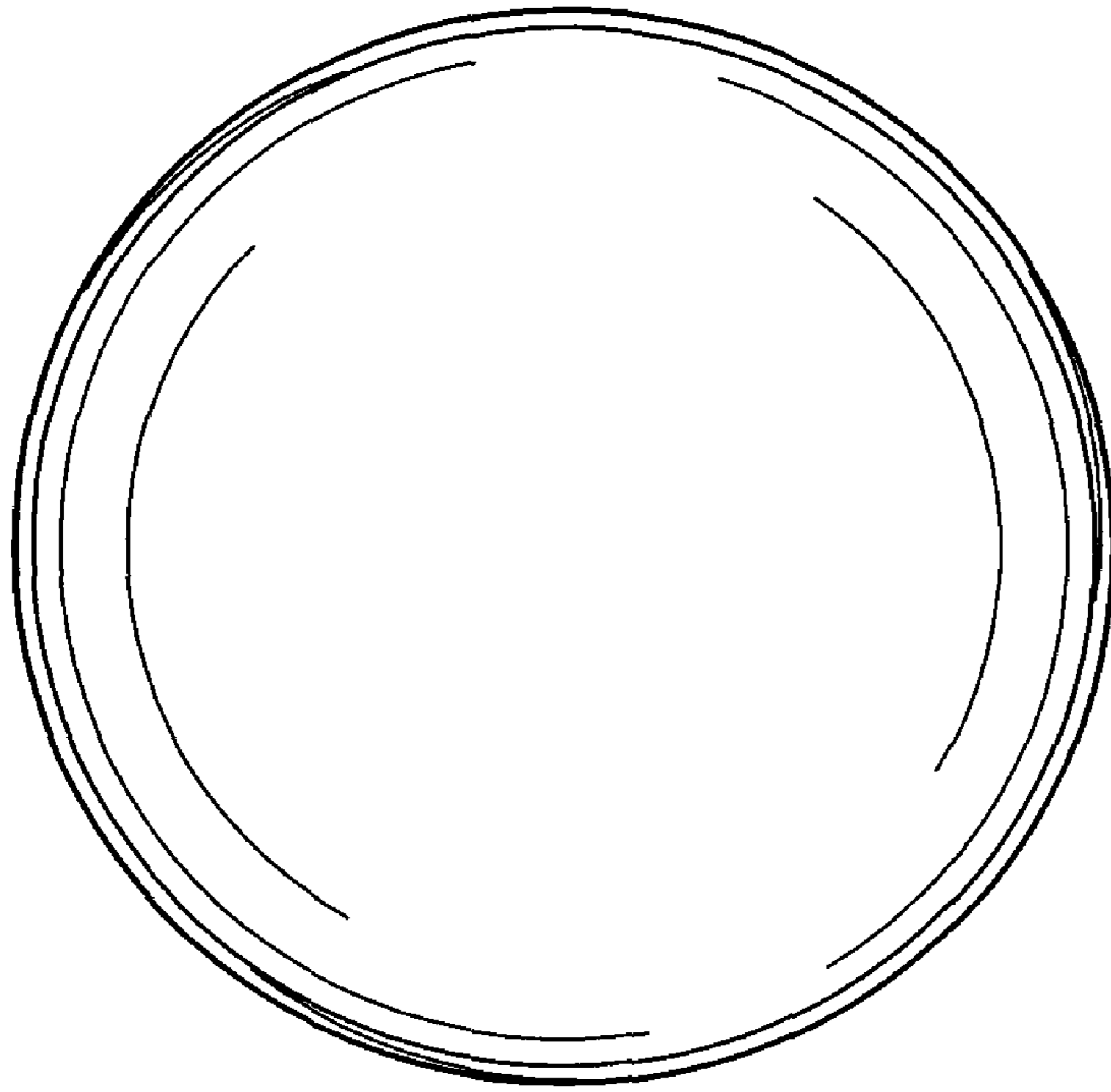

FIG. 6