



US00D572552S

(12) **United States Design Patent**
Feliciano

(10) **Patent No.:** **US D572,552 S**
(45) **Date of Patent:** **** Jul. 8, 2008**

(54) **QUICK-RELEASE PLIERS FOR PUSH-FIT COUPLERS AND ADAPTERS**

(76) Inventor: **Carlos Feliciano**, 812 E. Concord St., Orlando, FL (US) 32803

(**) Term: **14 Years**

(21) Appl. No.: **29/264,856**

(22) Filed: **Aug. 18, 2006**

(51) **LOC (8) Cl.** **08-05**

(52) **U.S. Cl.** **D8/52**

(58) **Field of Classification Search** D8/1, D8/4, 14, 51, 52, 54, 58, 71-74, 105-107; 7/106, 125, 127; 81/44, 300, 313, 314, 318-328, 81/330, 342, 349, 355, 380, 415, 416, 418, 81/420, 421, 424.5, 426, 426.5
See application file for complete search history.

(56) **References Cited**

U.S. PATENT DOCUMENTS

D70,109 S *	5/1926	Gowen	D8/53
D192,333 S *	3/1962	Buechler	D8/58
3,030,701 A *	4/1962	Regennitter	29/270
3,540,106 A *	11/1970	Goldman	29/268
4,571,808 A *	2/1986	King	29/268
4,757,588 A *	7/1988	Churchich	29/235

4,872,709 A *	10/1989	Stack	285/39
D312,194 S *	11/1990	McMiller	D7/682
5,591,203 A *	1/1997	Fahy	606/207
5,626,513 A *	5/1997	Curtis	452/125
D379,911 S *	6/1997	Arvizu	D8/52
5,793,018 A *	8/1998	Jett	219/225

* cited by examiner

Primary Examiner—Cathron Brooks

Assistant Examiner—Deanna Fluegeman

(74) *Attorney, Agent, or Firm*—Elsie C Turner

(57) **CLAIM**

The ornamental design for a quick-release pliers for push-fit couplers and adapters.

DESCRIPTION

FIG. 1 is a perspective view of quick-release pliers for push-fit couplers and adapters;

FIG. 2 is front elevational view thereof;

FIG. 3 is a top plan view thereof;

FIG. 4 is a bottom plan view thereof;

FIG. 5 is rear elevational view thereof;

FIG. 6 is a right-side elevational view thereof; and,

FIG. 7 is a left-side elevational view thereof.

1 Claim, 2 Drawing Sheets

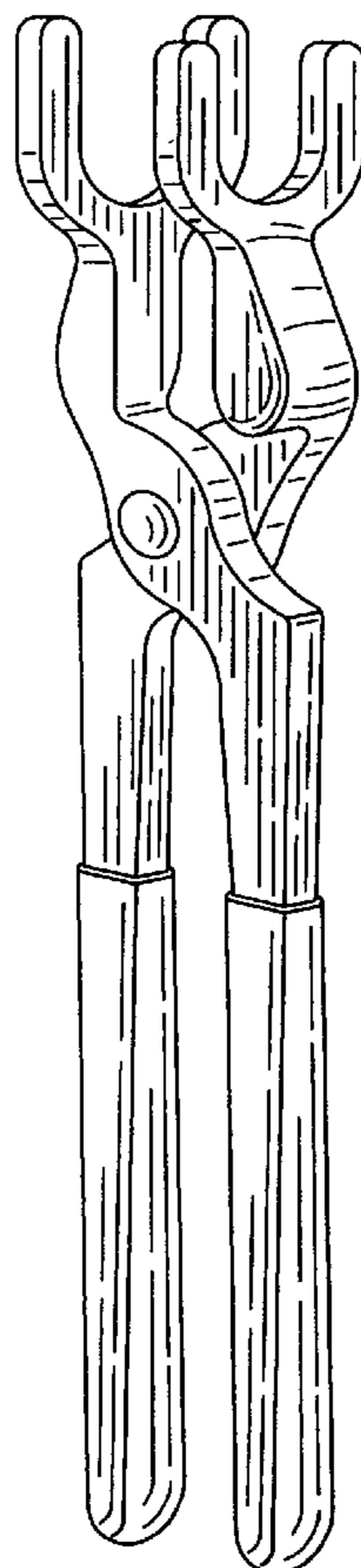

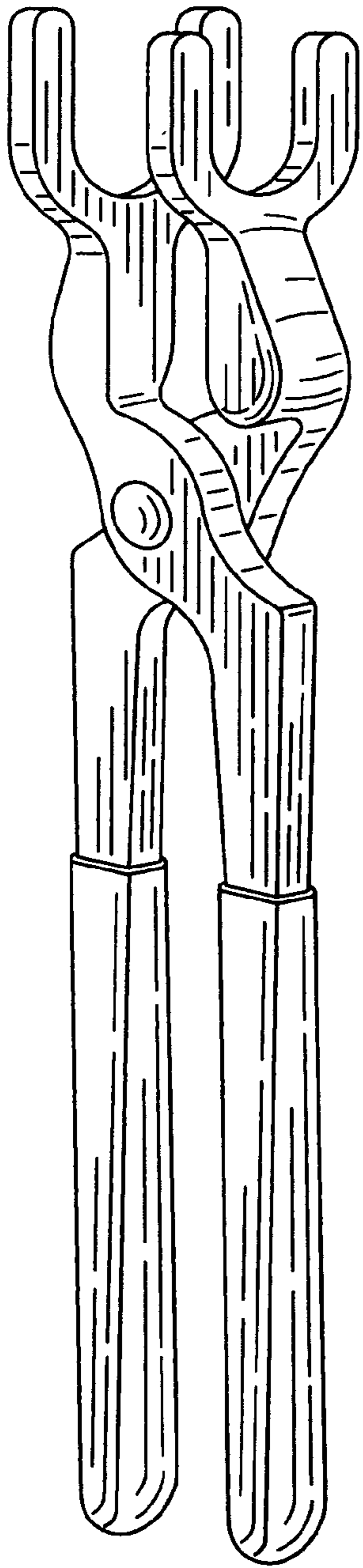

FIG. 1

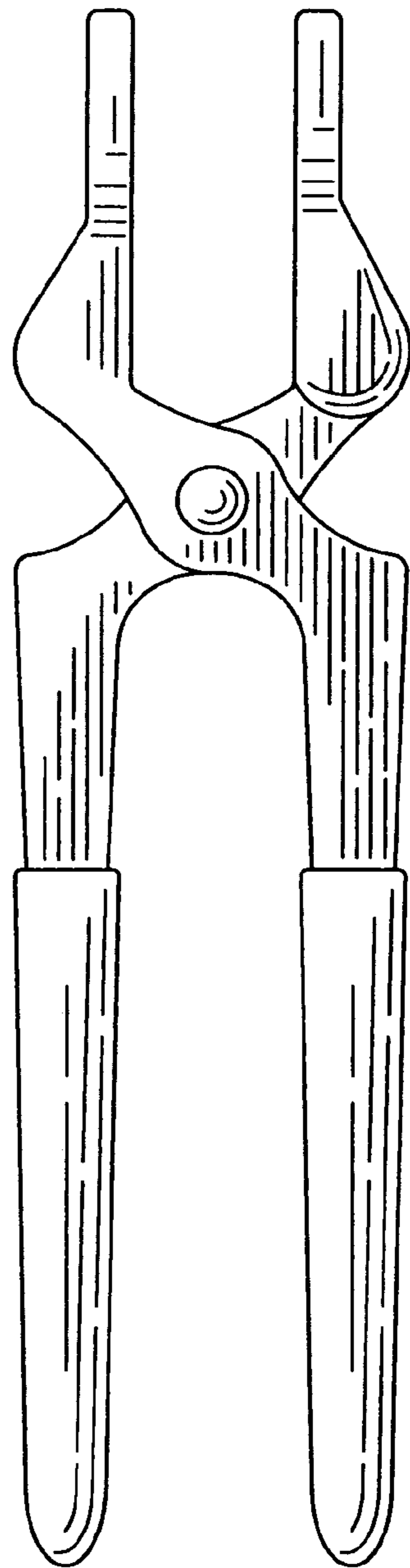

FIG. 2

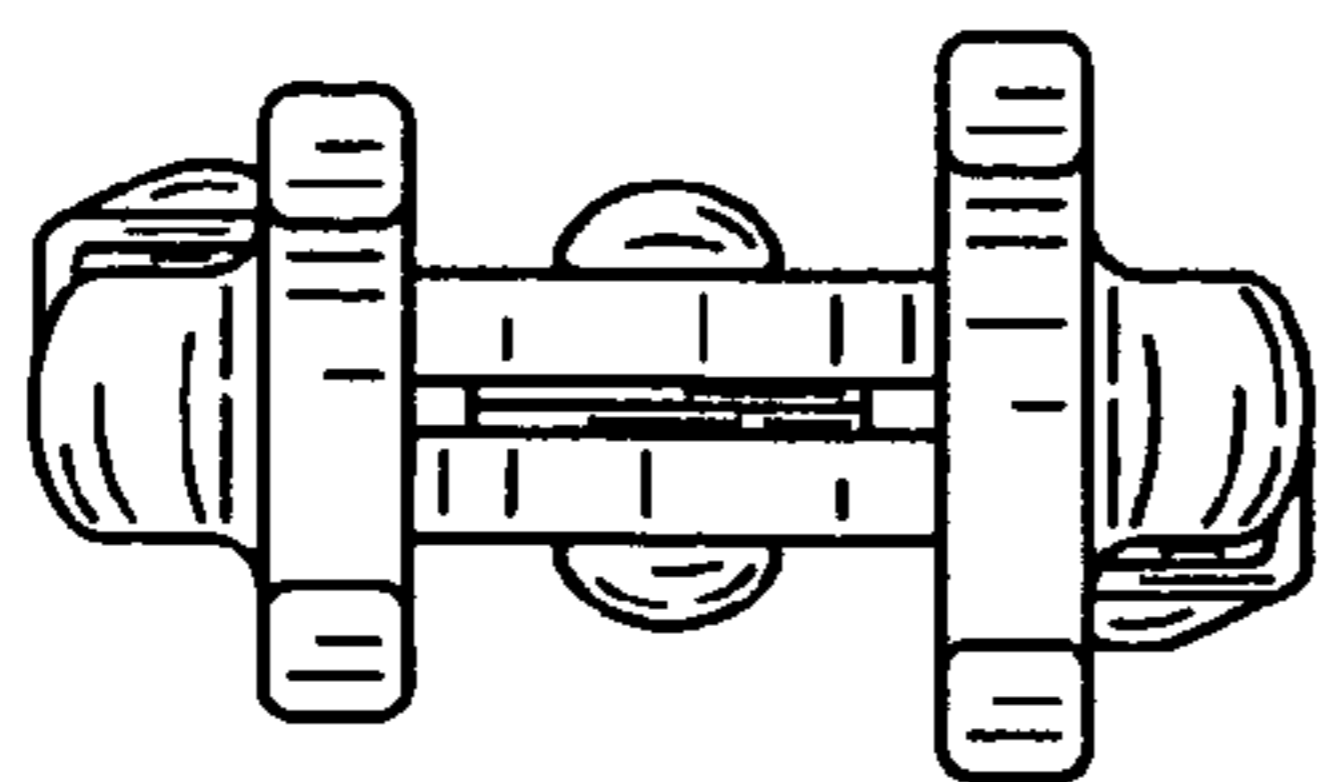

FIG. 3

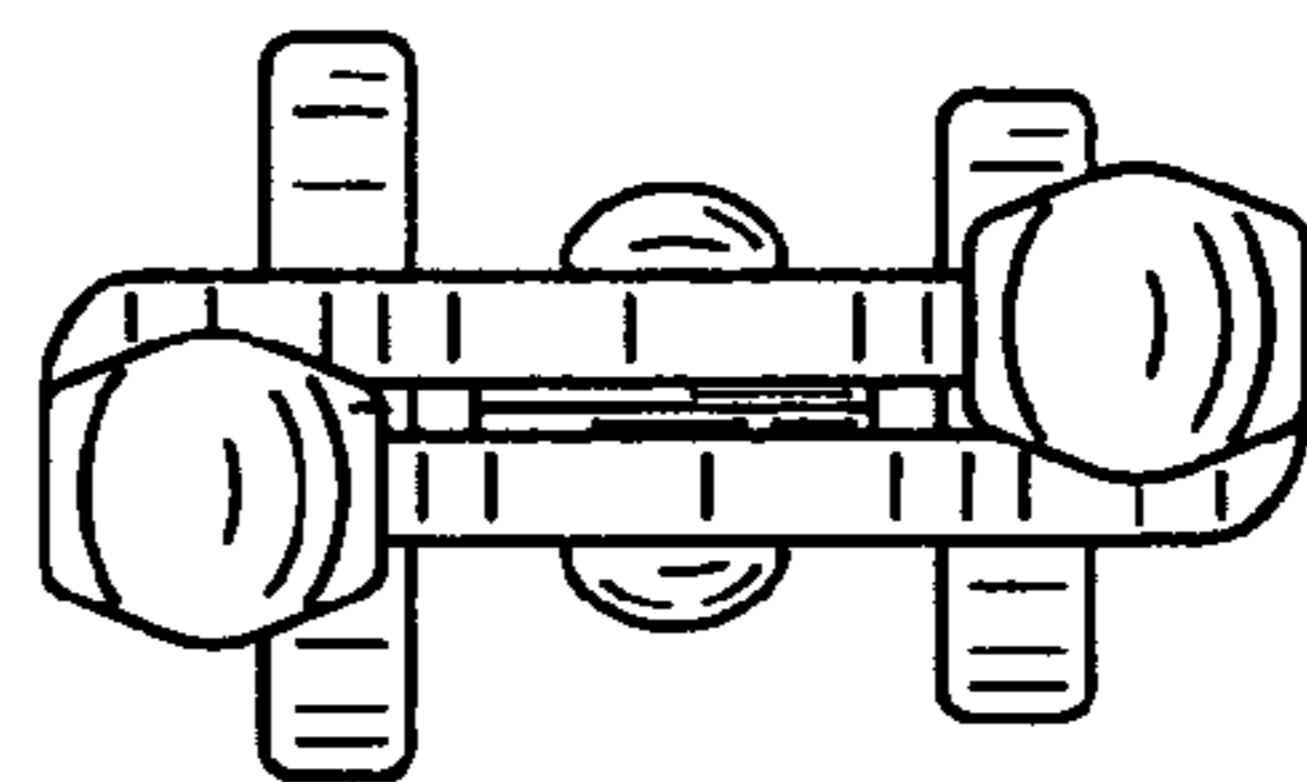

FIG. 4

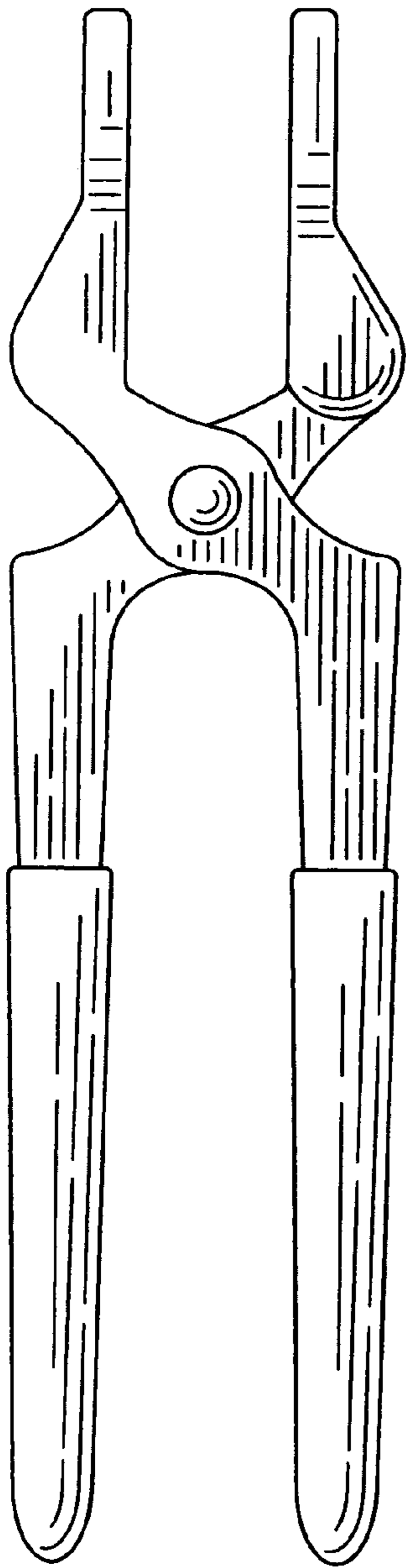

FIG. 5

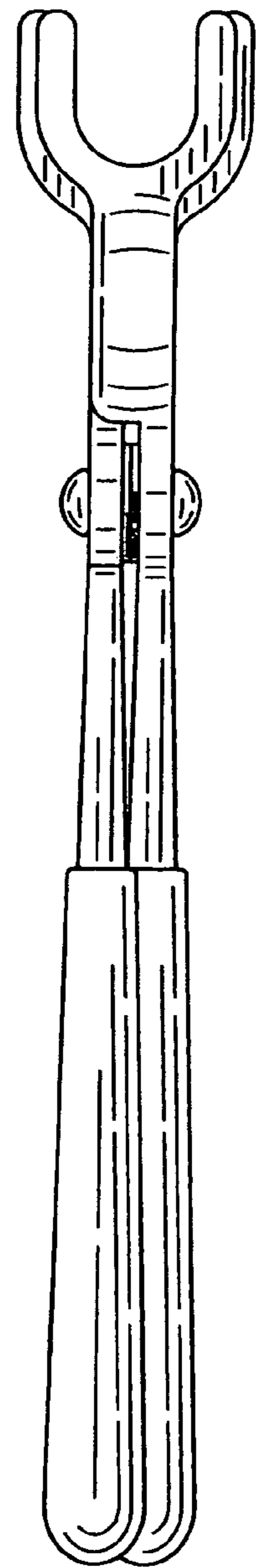

FIG. 6

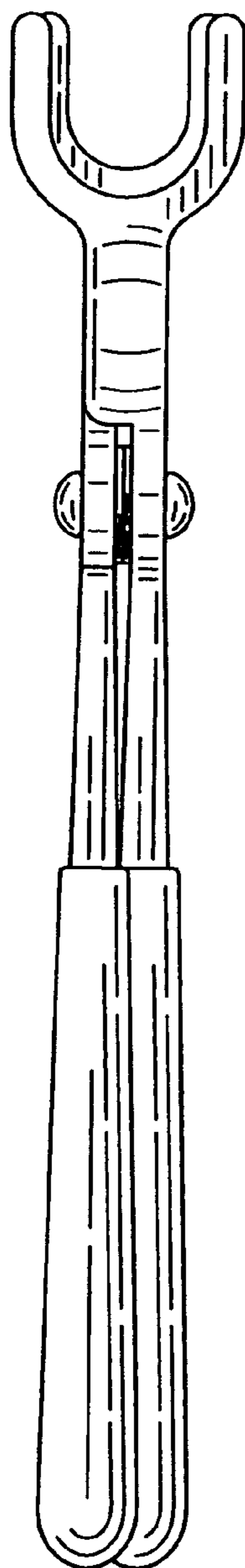

FIG. 7