



US00D572493S

(12) **United States Design Patent**  
**Zhang**

(10) **Patent No.:** **US D572,493 S**

(45) **Date of Patent:** **\*\* Jul. 8, 2008**

(54) **OFFICE CHAIR**

(76) Inventor: **George Zhang**, Ximenlong  
Neighborhood Committee, Min' An  
Town, Longshan County, Hu'Nan  
Province (CN)

(\*\*) Term: **14 Years**

(21) Appl. No.: **29/295,342**

(22) Filed: **Sep. 27, 2007**

(51) **LOC (8) Cl.** ..... **06-01**

(52) **U.S. Cl.** ..... **D6/366**

(58) **Field of Classification Search** ..... D6/334-336,  
D6/364-367, 374, 379, 380, 498, 500-502;  
297/393, 394, 396, 284.4, 411.2, 411.27,  
297/411.36, 452.13, 452.21, 452.29, 452.3,  
297/452.56, 452.64

See application file for complete search history.

(56) **References Cited**

**U.S. PATENT DOCUMENTS**

D481,879 S \* 11/2003 Su ..... D6/366  
D486,656 S \* 2/2004 Su ..... D6/366  
D489,191 S \* 5/2004 Ma ..... D6/366  
D512,232 S \* 12/2005 Wu ..... D6/366

D534,365 S \* 1/2007 Breen ..... D6/366  
D541,062 S \* 4/2007 Su ..... D6/366  
D548,994 S \* 8/2007 Mao et al. .... D6/366  
D549,473 S \* 8/2007 Wagner ..... D6/366  
D549,976 S \* 9/2007 Lin ..... D6/366  
D552,857 S \* 10/2007 Wang ..... D6/366  
2005/0062323 A1 \* 3/2005 Dicks ..... 297/284.4

\* cited by examiner

*Primary Examiner*—Mimosa De

(57) **CLAIM**

The ornamental design for an office chair, as shown.

**DESCRIPTION**

FIG. 1 is a front elevational view of an office chair showing my new design;

FIG. 2 is a rear elevational view thereof;

FIG. 3 is a top plan view thereof;

FIG. 4 is a bottom plan view thereof;

FIG. 5 is a right side view thereof;

FIG. 6 is a left side view thereof; and,

FIG. 7 is a perspective view thereof.

**1 Claim, 4 Drawing Sheets**

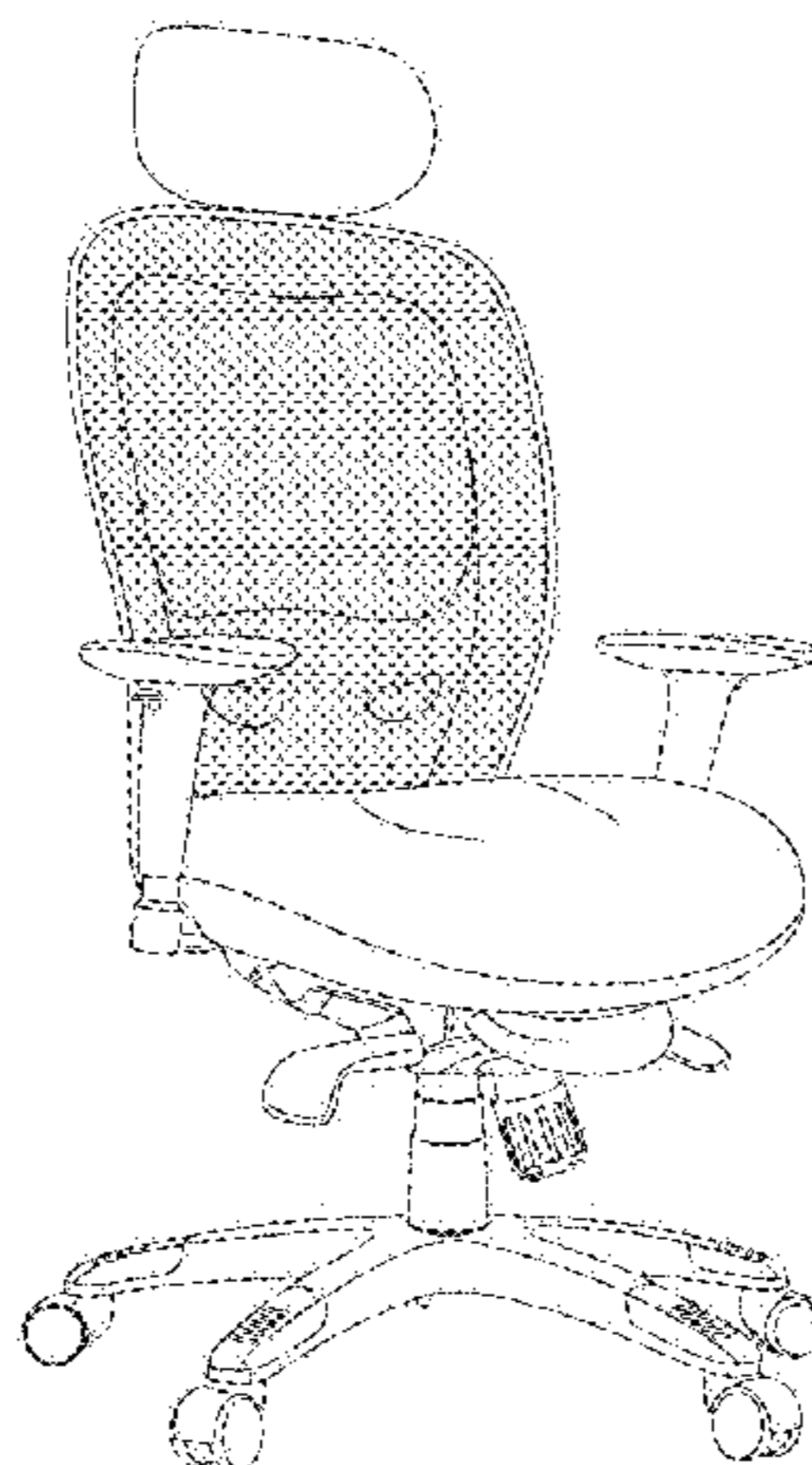
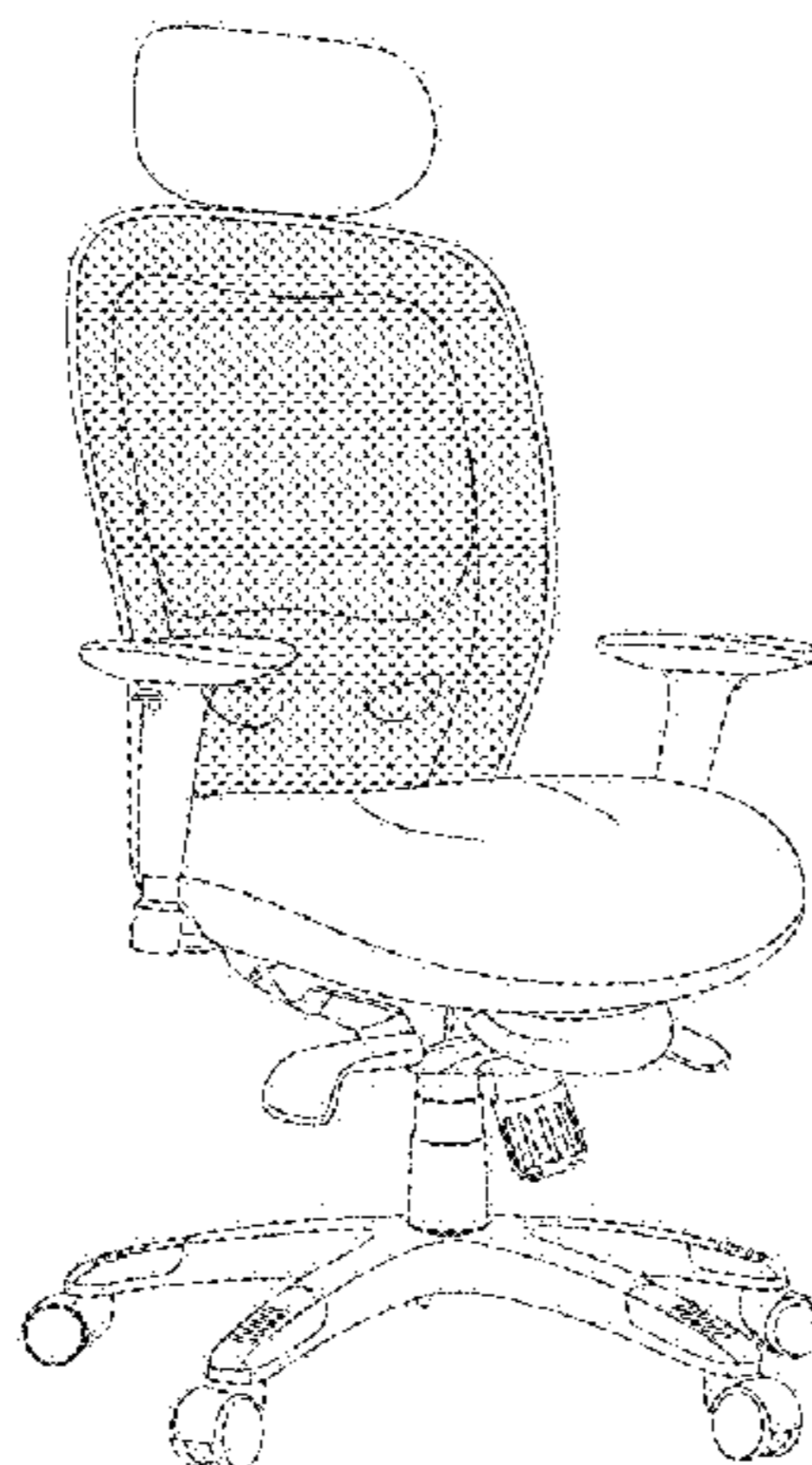
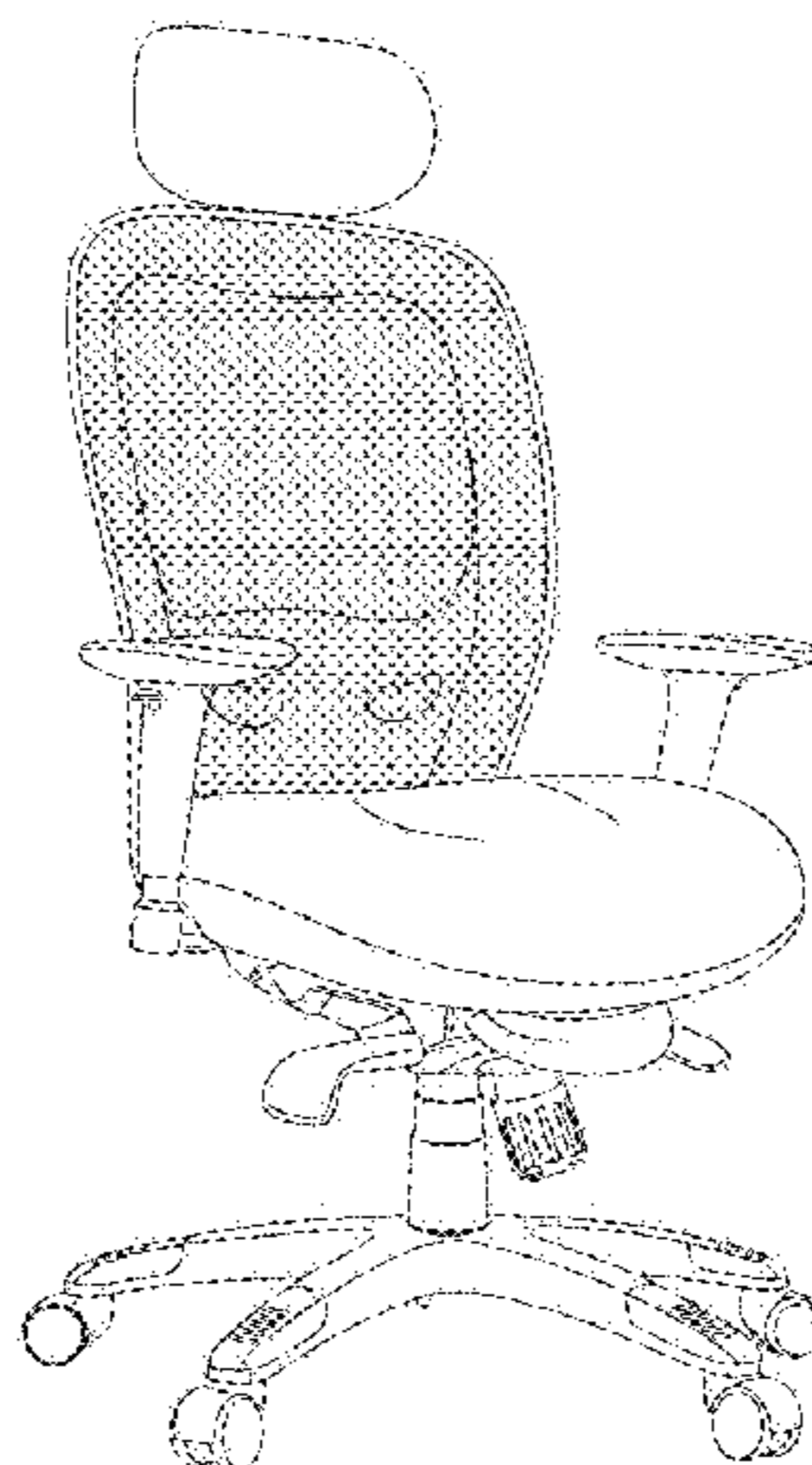
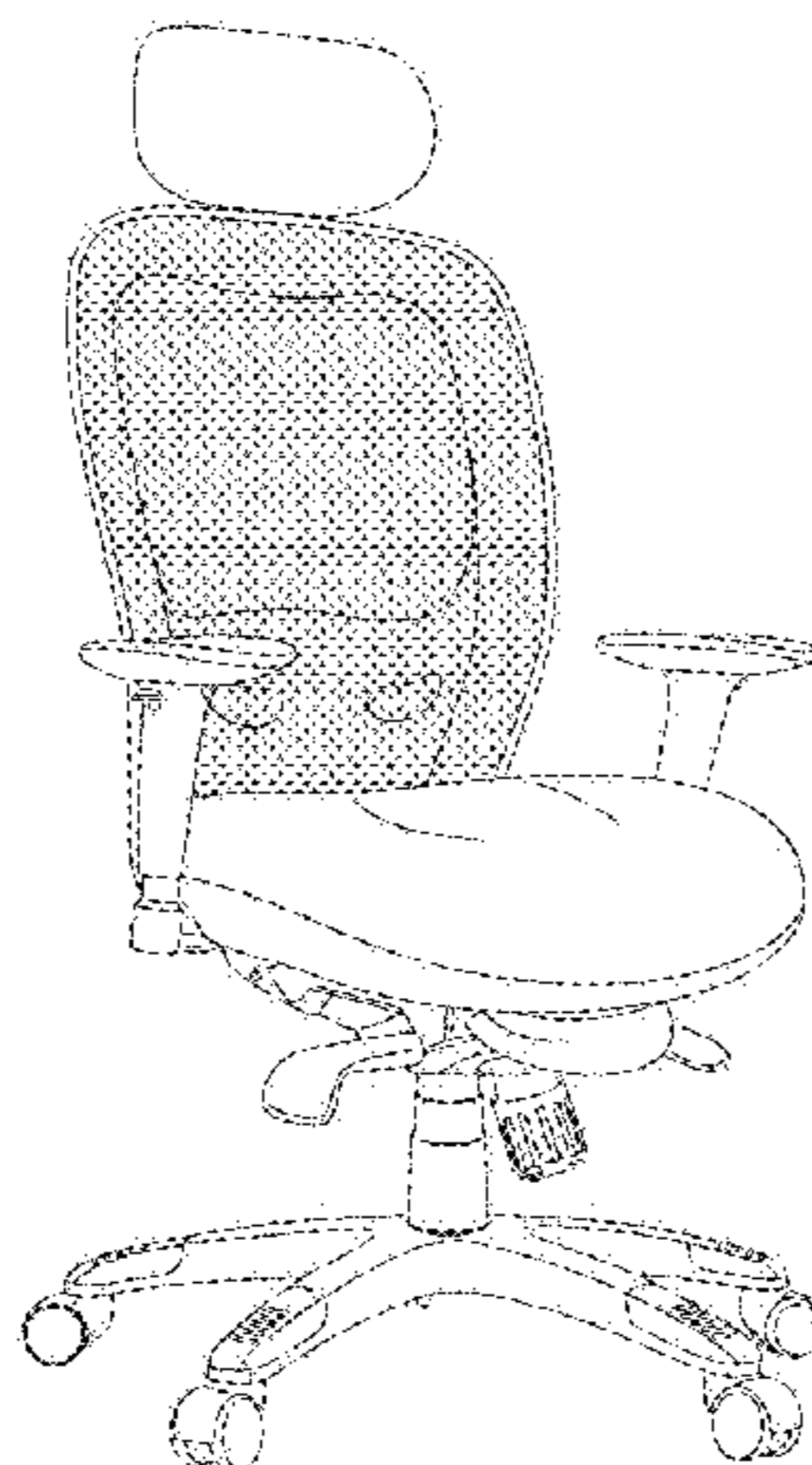
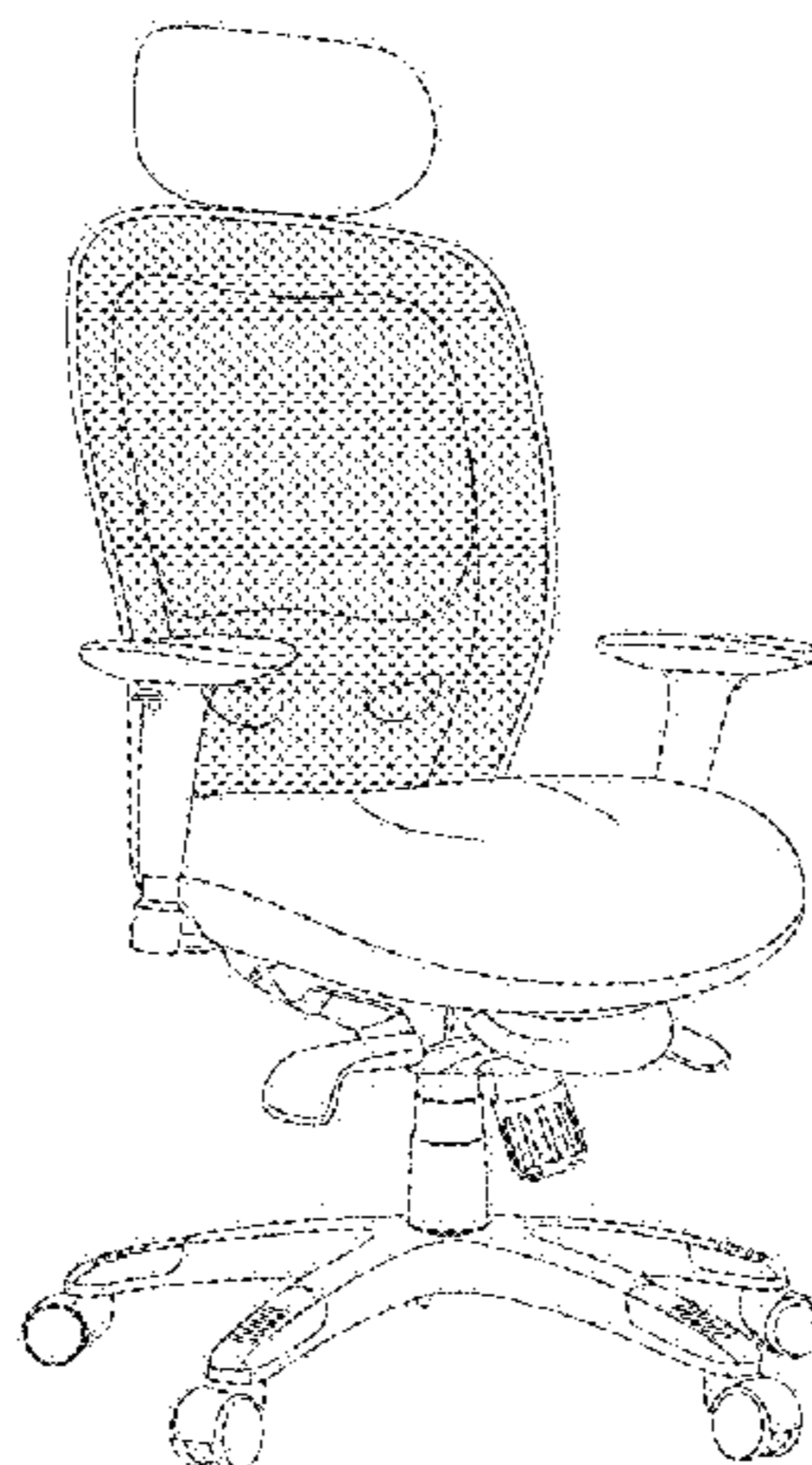
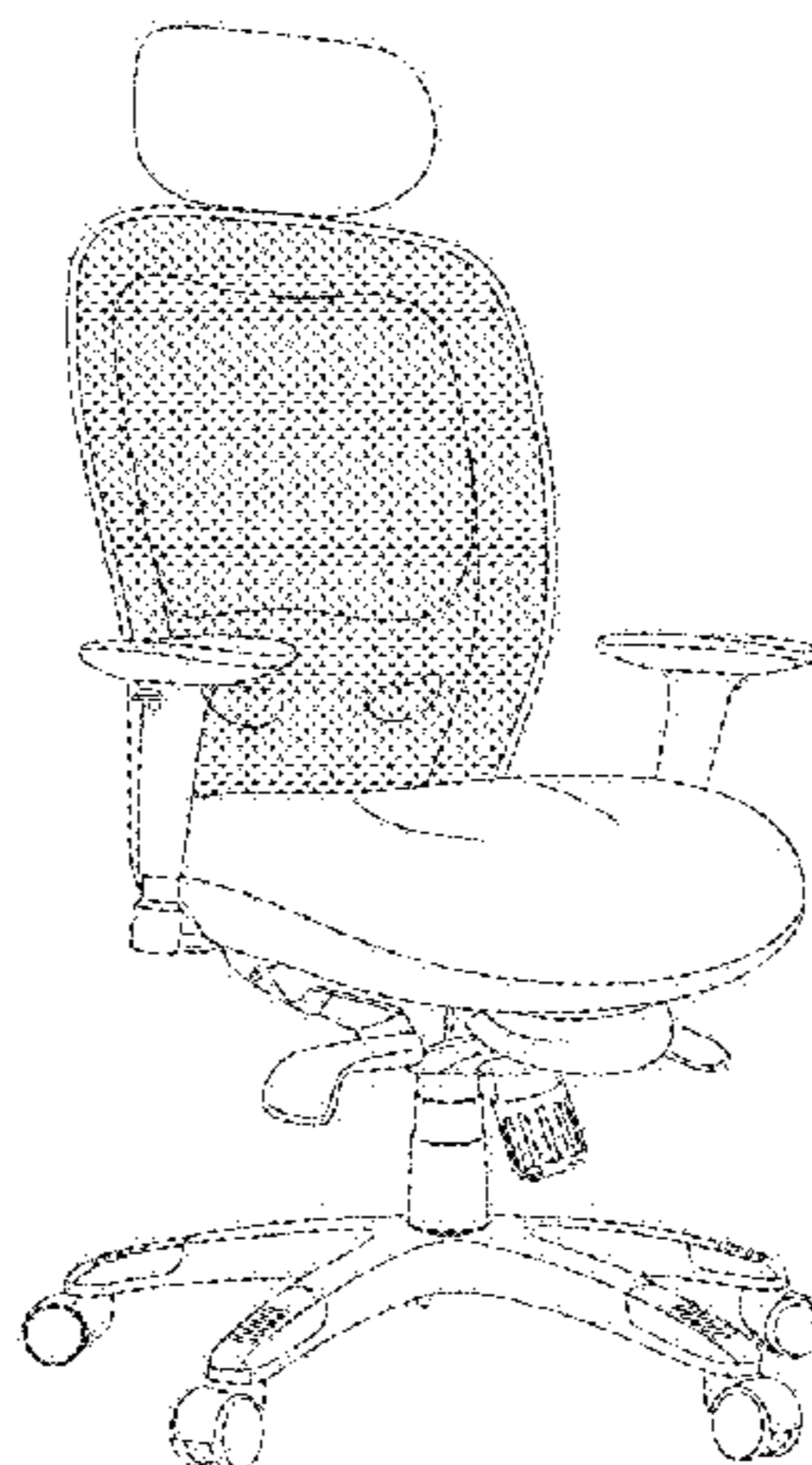
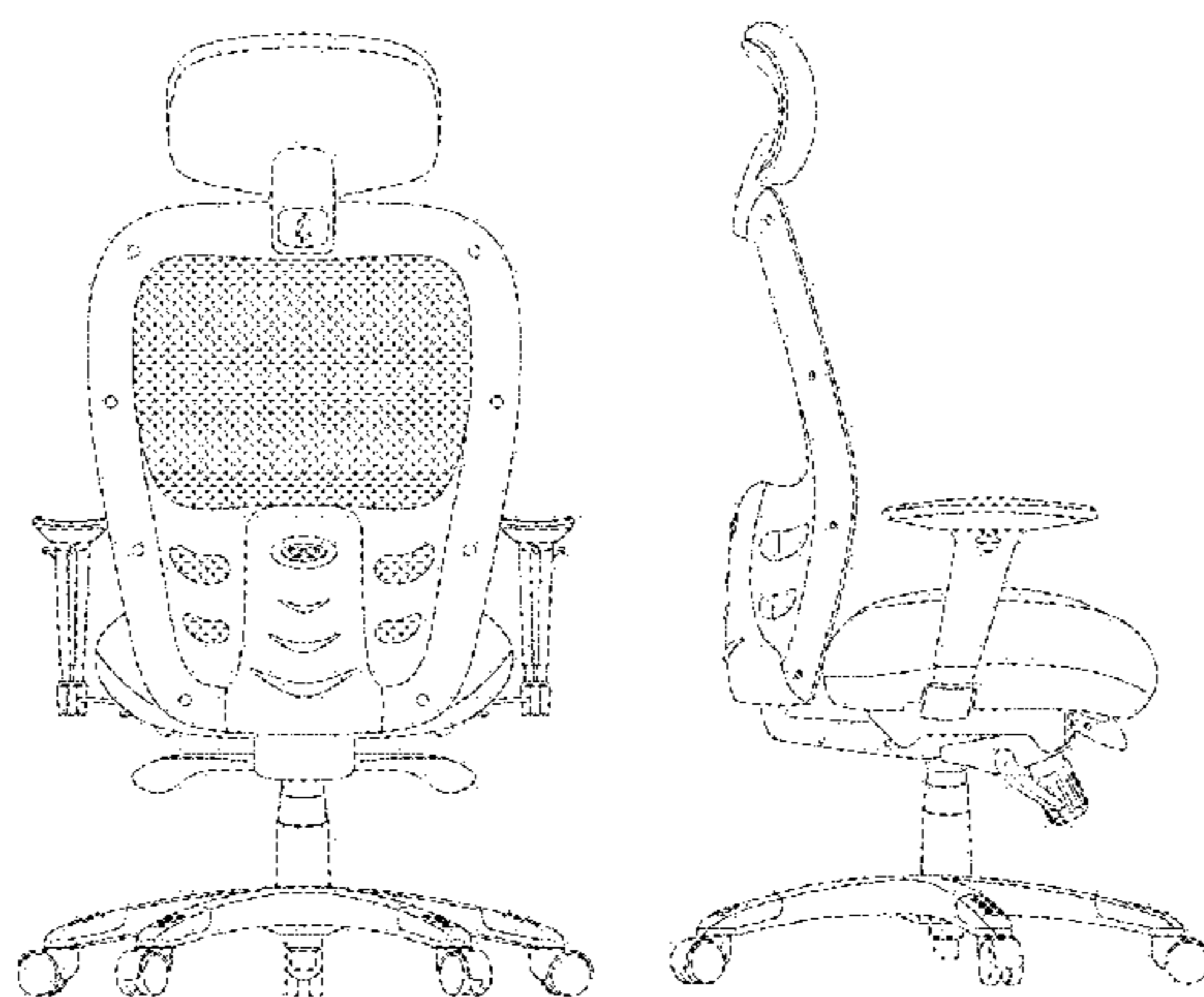

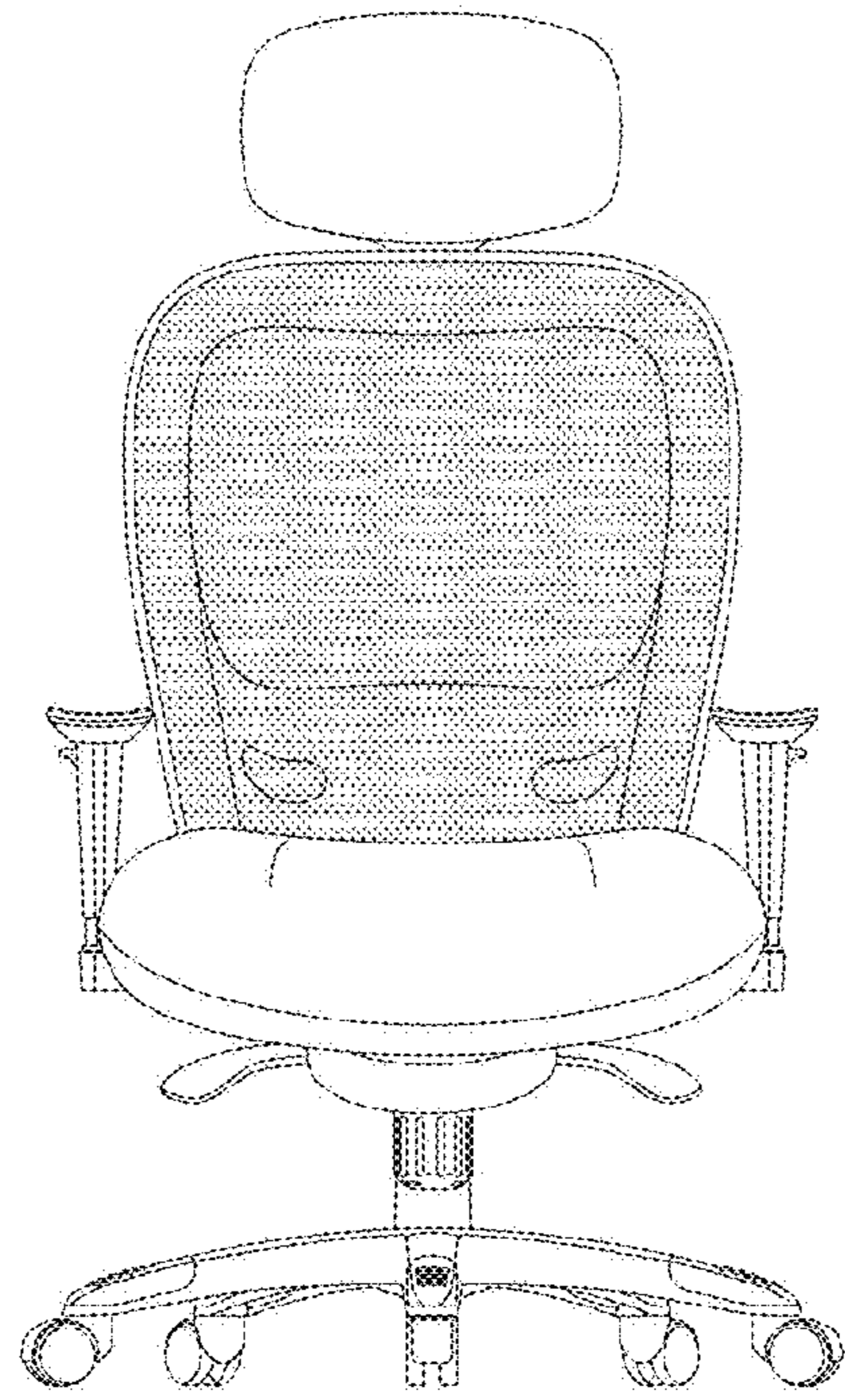

FIG. 1

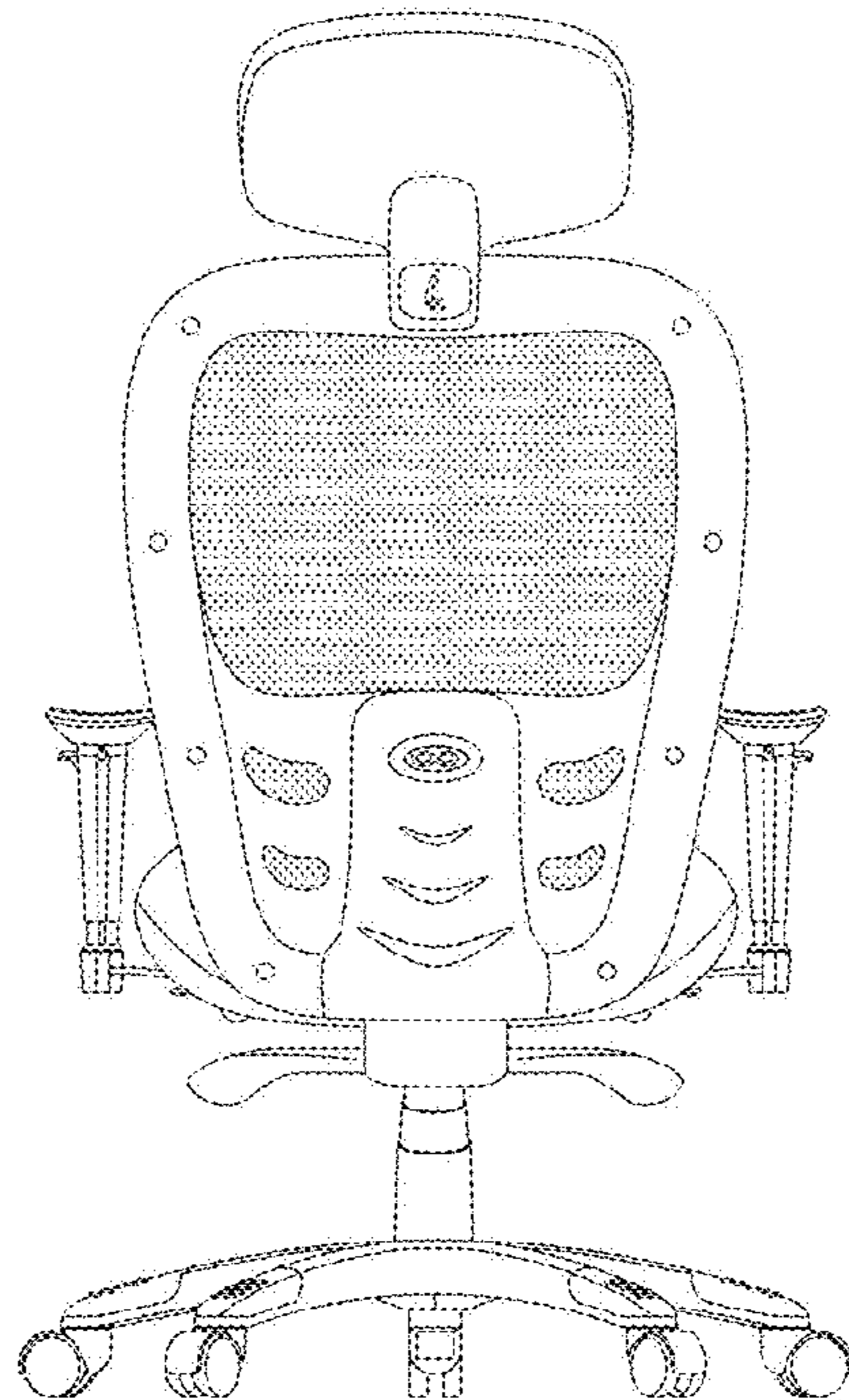

FIG. 2

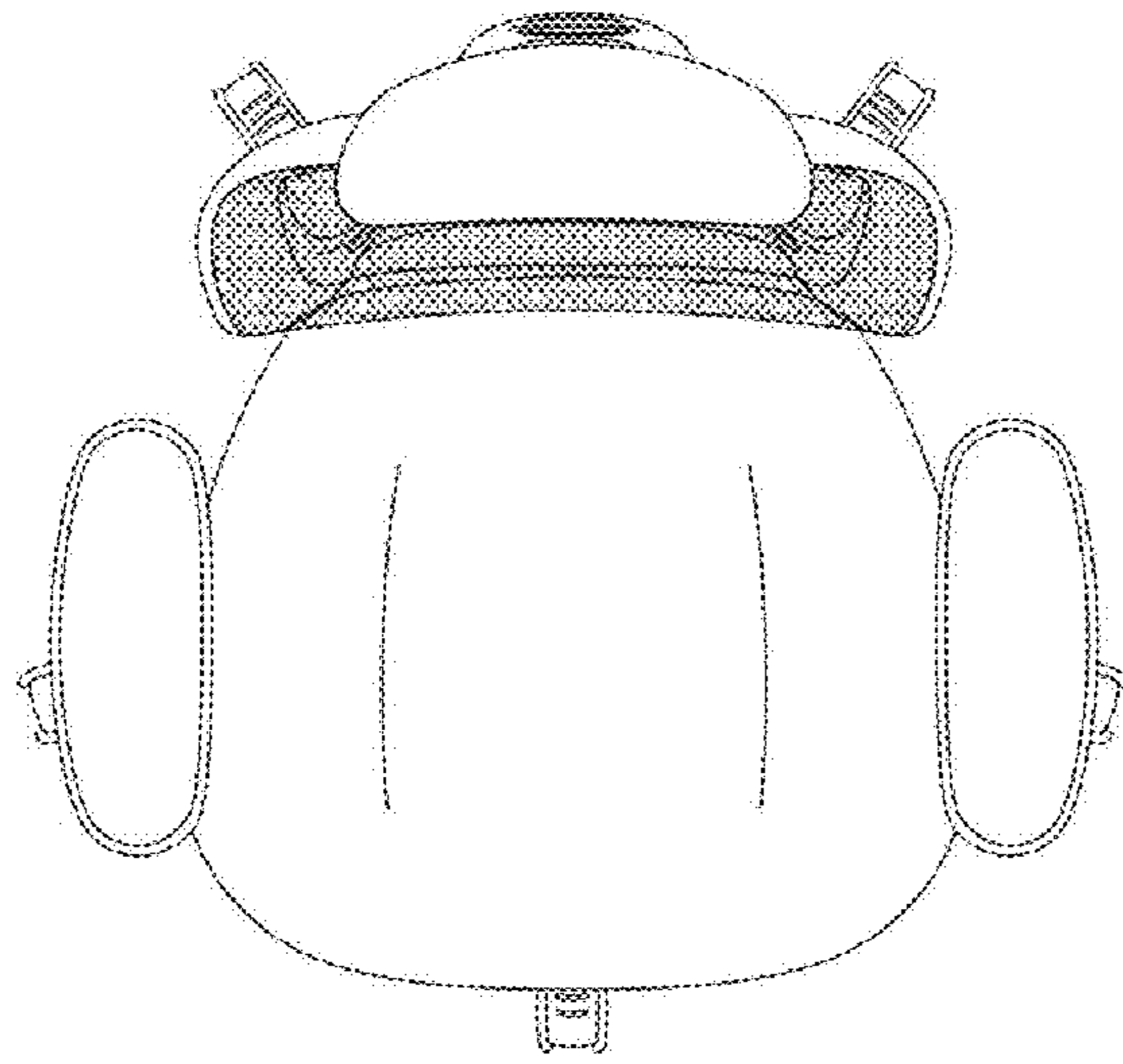

FIG. 3

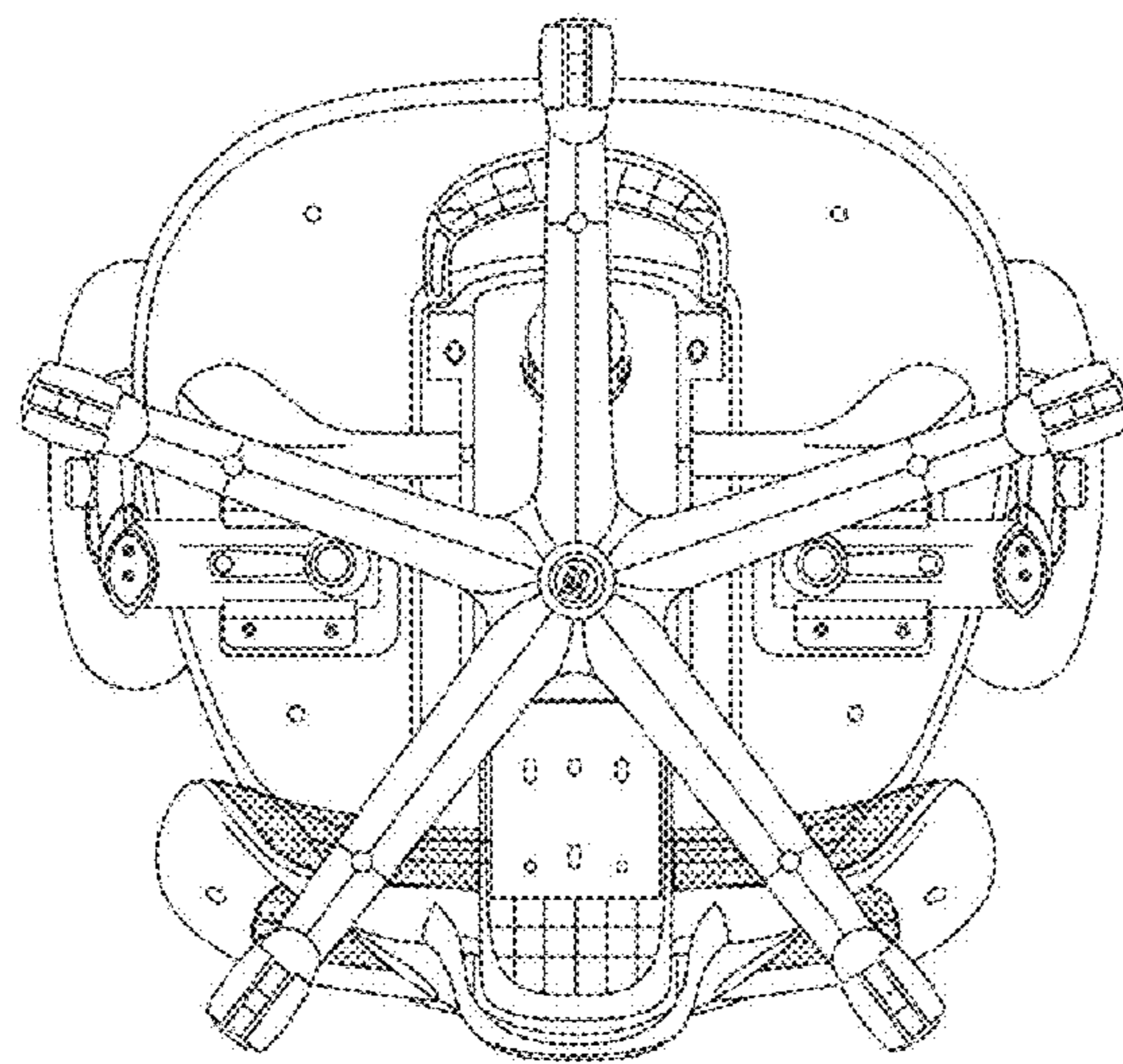

FIG. 4

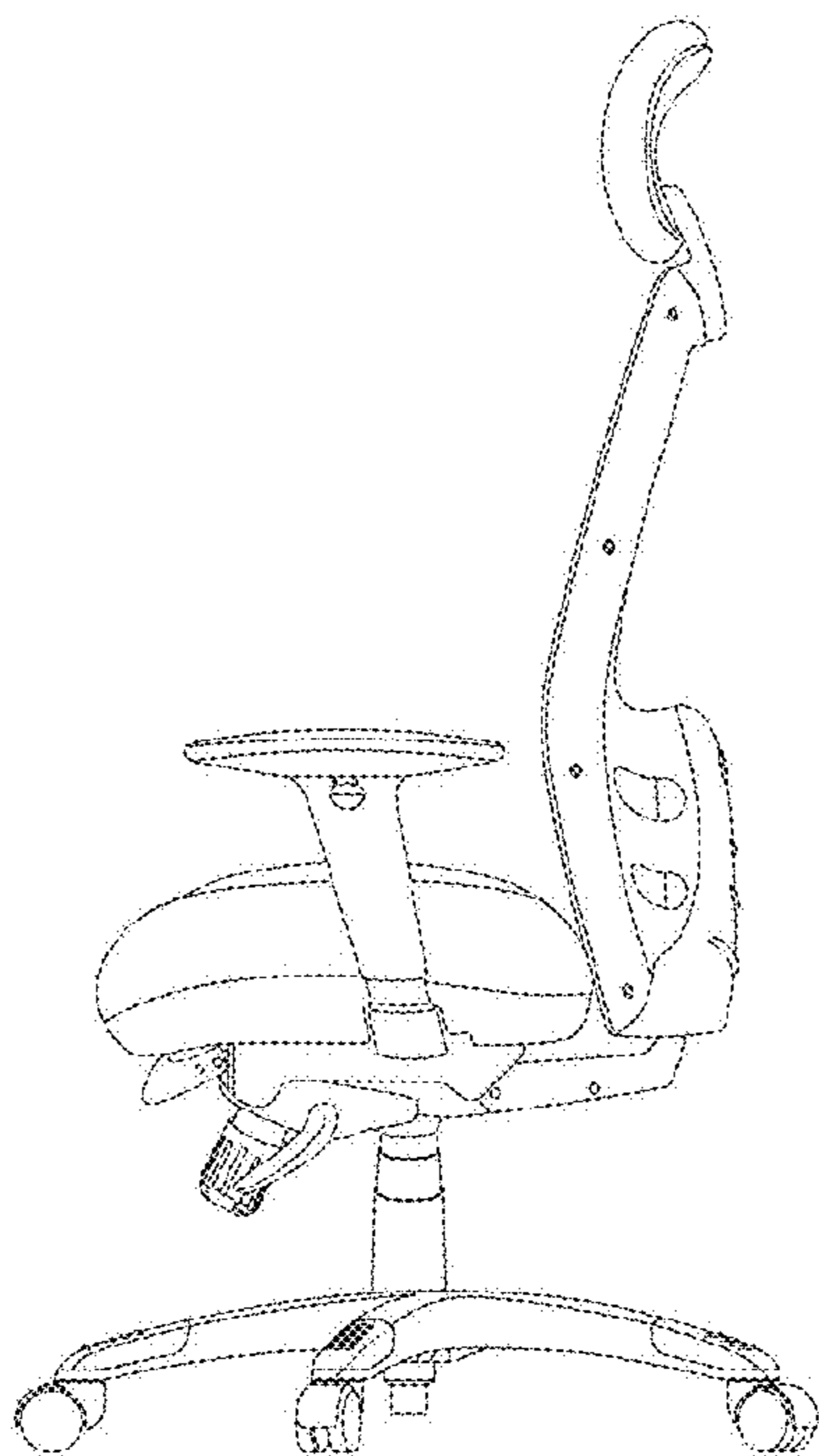

FIG. 5

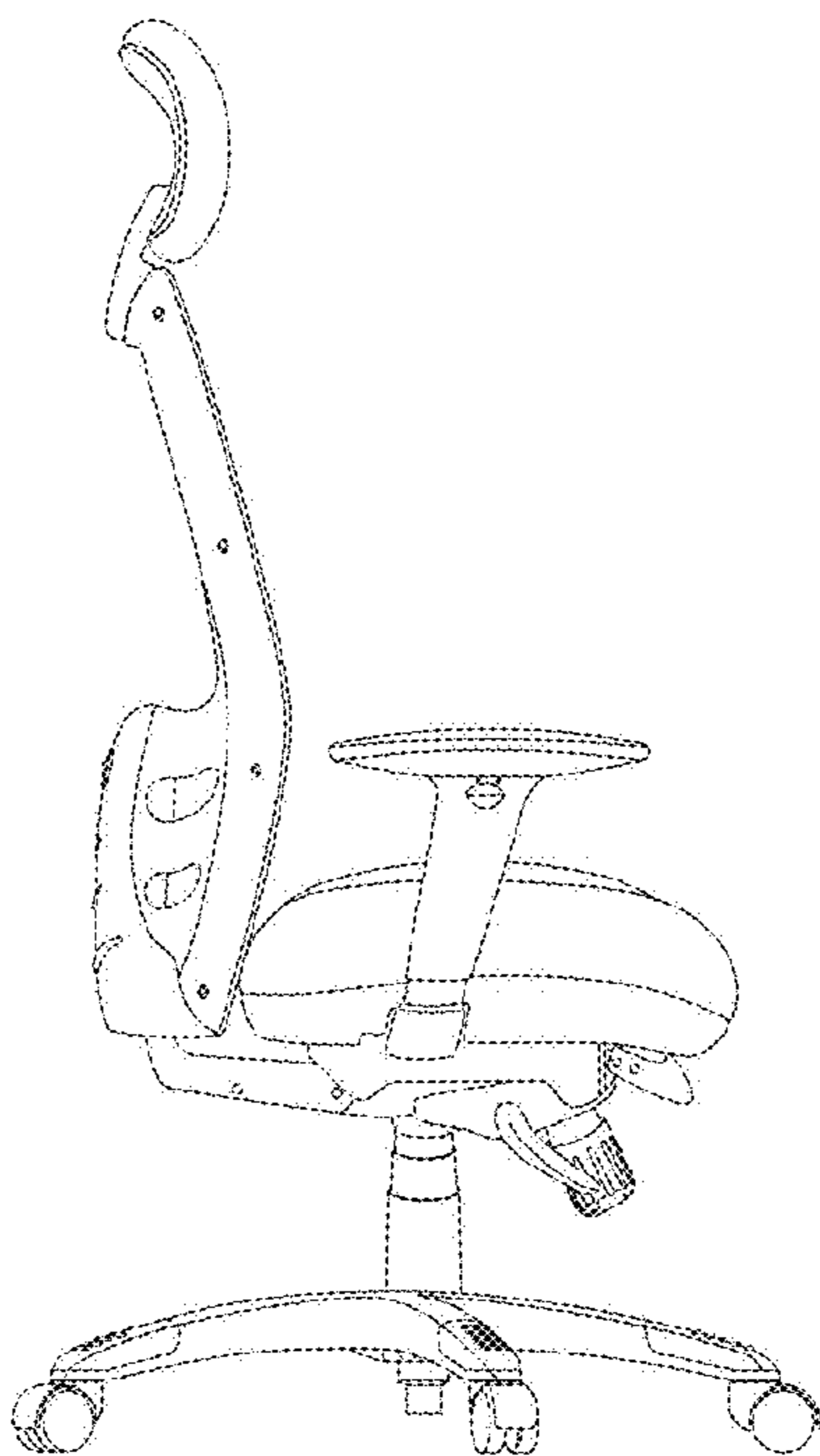

FIG. 6



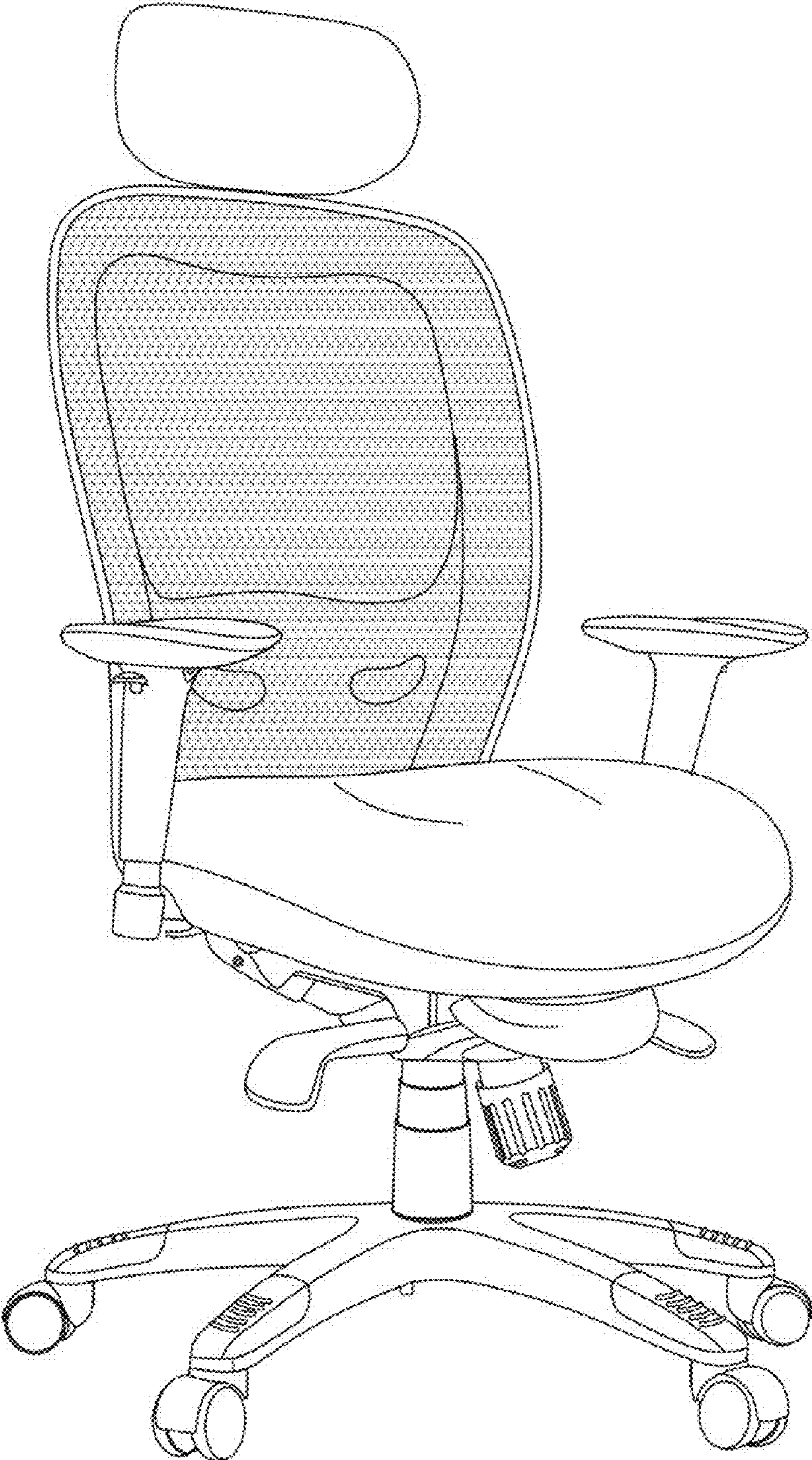

FIG. 7