



US00D572469S

(12) **United States Design Patent**
Morelli

(10) **Patent No.:** **US D572,469 S**
(45) **Date of Patent:** **** Jul. 8, 2008**

(54) **HANDBAG**

(75) Inventor: **Giovanni Morelli**, Milan (IT)

(73) Assignee: **Chloe Societe Anonyme**, Paris (FR)

(**) Term: **14 Years**

(21) Appl. No.: **29/254,394**

(22) Filed: **Feb. 22, 2006**

(51) **LOC (8) Cl.** **03-01**

(52) **U.S. Cl.** **D3/232**

(58) **Field of Classification Search** D3/232,
D3/234, 238, 240–246, 303, 318–326, 900,
D3/902; 150/100, 107–111, 118–120; 190/100,
190/108–112, 115, 900, 902–903
See application file for complete search history.

(56) **References Cited**

U.S. PATENT DOCUMENTS

D390,004 S *	2/1998	Tawil	D3/246
D426,060 S *	6/2000	Chapelier	D3/303
D453,621 S *	2/2002	Chapelier	D3/252
D459,076 S *	6/2002	Chapelier	D3/289
D465,925 S *	11/2002	Chapelier	D3/303
D472,046 S *	3/2003	Galliano	D3/243
D492,482 S *	7/2004	Hanley	D3/243
D533,716 S *	12/2006	Brocart	D3/246
D538,532 S *	3/2007	Cassegrain	D3/232
D543,027 S *	5/2007	Wang	D3/246

* cited by examiner

Primary Examiner—Louis S Zarfaz

Assistant Examiner—Michelle E Wilson

(74) *Attorney, Agent, or Firm*—Kalow & Springut, LLP

(57) **CLAIM**

The ornamental design of a handbag, as shown and described.

DESCRIPTION

FIG. 1 is a front view of a first embodiment of a handbag.



FIG. 2 is a rear view of the first embodiment of a handbag.

FIG. 3 is a top view of the first embodiment of a handbag.

FIG. 4 is bottom view of the first embodiment of a handbag.

FIG. 5 is a left side view of the first embodiment of a handbag.

FIG. 6 is right side view of the first embodiment of a handbag.

FIG. 7 is a front view of a second embodiment of a handbag.

FIG. 8 is a rear view of the second embodiment of a handbag.

FIG. 9 is a right side view of the second embodiment of a handbag.

FIG. 10 is a left side view of the second embodiment of a handbag.

FIG. 11 is a bottom view of the second embodiment of a handbag.

FIG. 12 is a top view of the second embodiment of a handbag.

FIG. 13 is a front view of a third embodiment of a handbag.

FIG. 14 is a rear view of the third embodiment of a handbag.

FIG. 15 is a top view of the third embodiment of a handbag.

FIG. 16 is a bottom view of the third embodiment of the handbag.

FIG. 17 is a right side view of the third embodiment of a handbag.

FIG. 18 is a left side view of the third embodiment of a handbag.

FIG. 19 is a rear view of a fourth embodiment of a handbag.

FIG. 20 is a front view of the fourth embodiment of a handbag.

FIG. 21 is a top view of the fourth embodiment of the handbag.

FIG. 22 is a bottom view of the fourth embodiment of a handbag.

FIG. 23 is a right side view of the fourth embodiment of a handbag.

FIG. 24 is a left side view of the fourth embodiment of a handbag.

FIG. 25 is a rear view of a fifth embodiment of a handbag.

FIG. 26 is a front view of the fifth embodiment of a handbag.

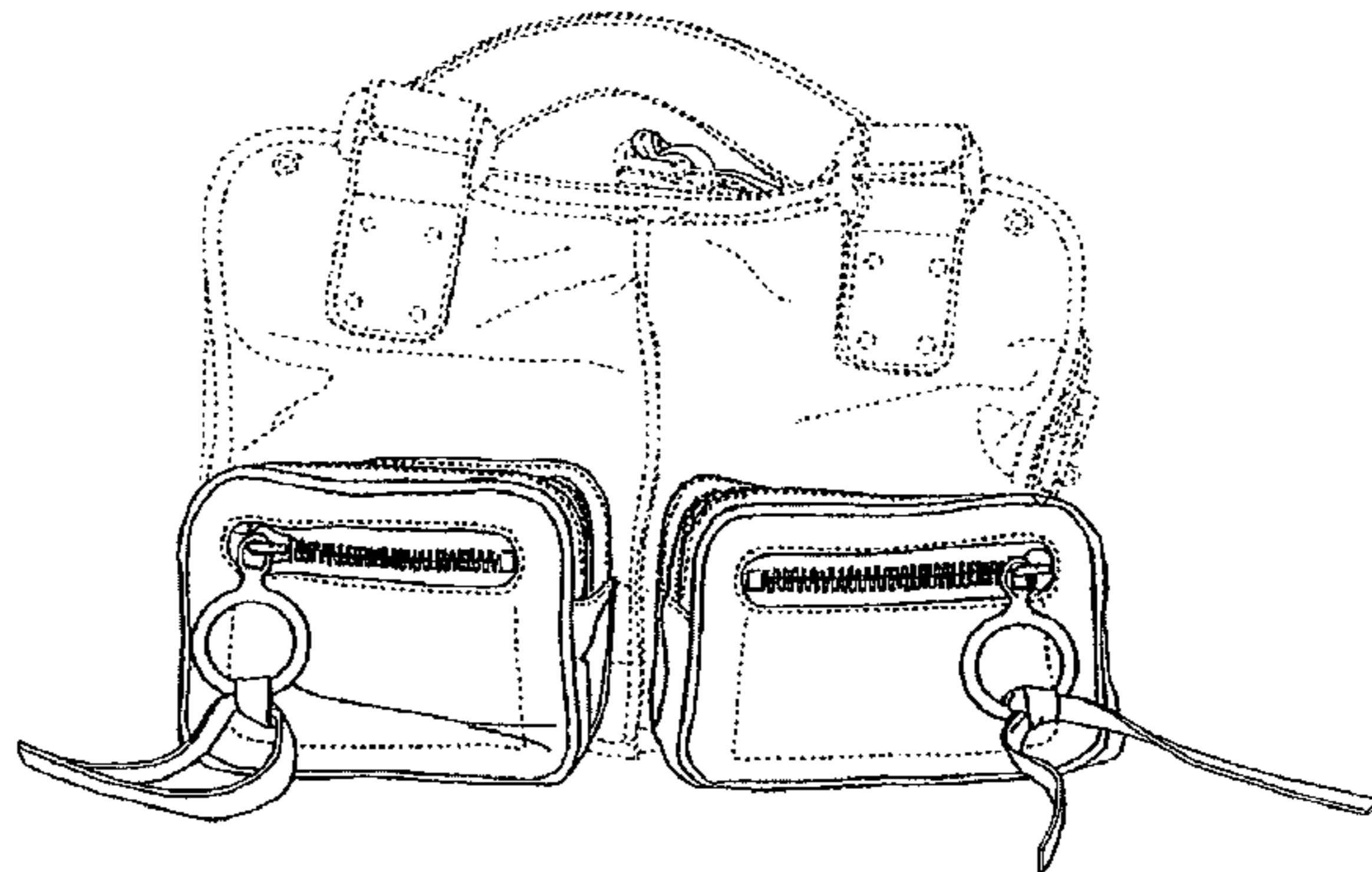

FIG. 27 is a top view of the fifth embodiment of a handbag.

FIG. 28 is a bottom view of the fifth embodiment of a handbag.

FIG. 29 is a right side view of the fifth embodiment of a handbag.

FIG. 30 is a left side view of the fifth embodiment of a handbag.

FIG. 31 is a front view of a sixth embodiment of a handbag.

FIG. 32 is a rear view of the sixth embodiment of a handbag.

FIG. 33 is a top view of the sixth embodiment of a handbag.

FIG. 34 is a bottom view of the sixth embodiment of a handbag.

FIG. 35 is a right side view of the sixth embodiment of a handbag.

FIG. 36 is a left side view of the sixth embodiment of a handbag.

FIG. 37 is a first front view of a seventh embodiment of a handbag.

FIG. 38 is a second front view of the seventh embodiment of a handbag.

FIG. 39 is a rear view of the seventh embodiment of a handbag.

FIG. 40 is a top view of the seventh embodiment of a handbag.

FIG. 41 is a bottom view of the seventh embodiment of a handbag.

FIG. 42 is a right side view of the seventh embodiment of a handbag.

FIG. 43 is a left side view of the seventh embodiment of a handbag.

FIG. 44 is a perspective view of an eighth embodiment of a handbag.

FIG. 45 is a front view of the eighth embodiment of a handbag.

FIG. 46 is a rear view of the eighth embodiment of a handbag.

FIG. 47 is a top view of the eighth embodiment of a handbag.

FIG. 48 is a bottom view of the eighth embodiment of a handbag.

FIG. 49 is a left side view of the eighth embodiment of a handbag.

FIG. 50 is a right side view of the eighth embodiment of a handbag.

FIG. 51 is a back view of a ninth embodiment of a handbag.

FIG. 52 is a rear view of the ninth embodiment of a handbag.

FIG. 53 is a front view of the ninth embodiment of a handbag.

FIG. 54 is a left side view of the ninth embodiment of a handbag.

FIG. 55 is a right side view of the ninth embodiment of a handbag.

FIG. 56 is a top view of the ninth embodiment of handbag.

FIG. 57 is a bottom view of the ninth embodiment of a handbag.

FIG. 58 is a perspective view of a tenth embodiment of a handbag.

FIG. 59 is a perspective view of an eleventh embodiment of a handbag.

FIG. 60 is a perspective view of a twelfth embodiment of a handbag.

FIG. 61 is a perspective view of a thirteenth embodiment of a handbag.

FIG. 62 is a perspective view of a fourteenth embodiment of a handbag; and,

FIG. 63 is a persepctive view a fifteenth embodiment of a handbag.

The broken lines of the figures are for illustrative purposes only and form no part of the claimed design.

1 Claim, 61 Drawing Sheets



FIG. 1



FIG. 2

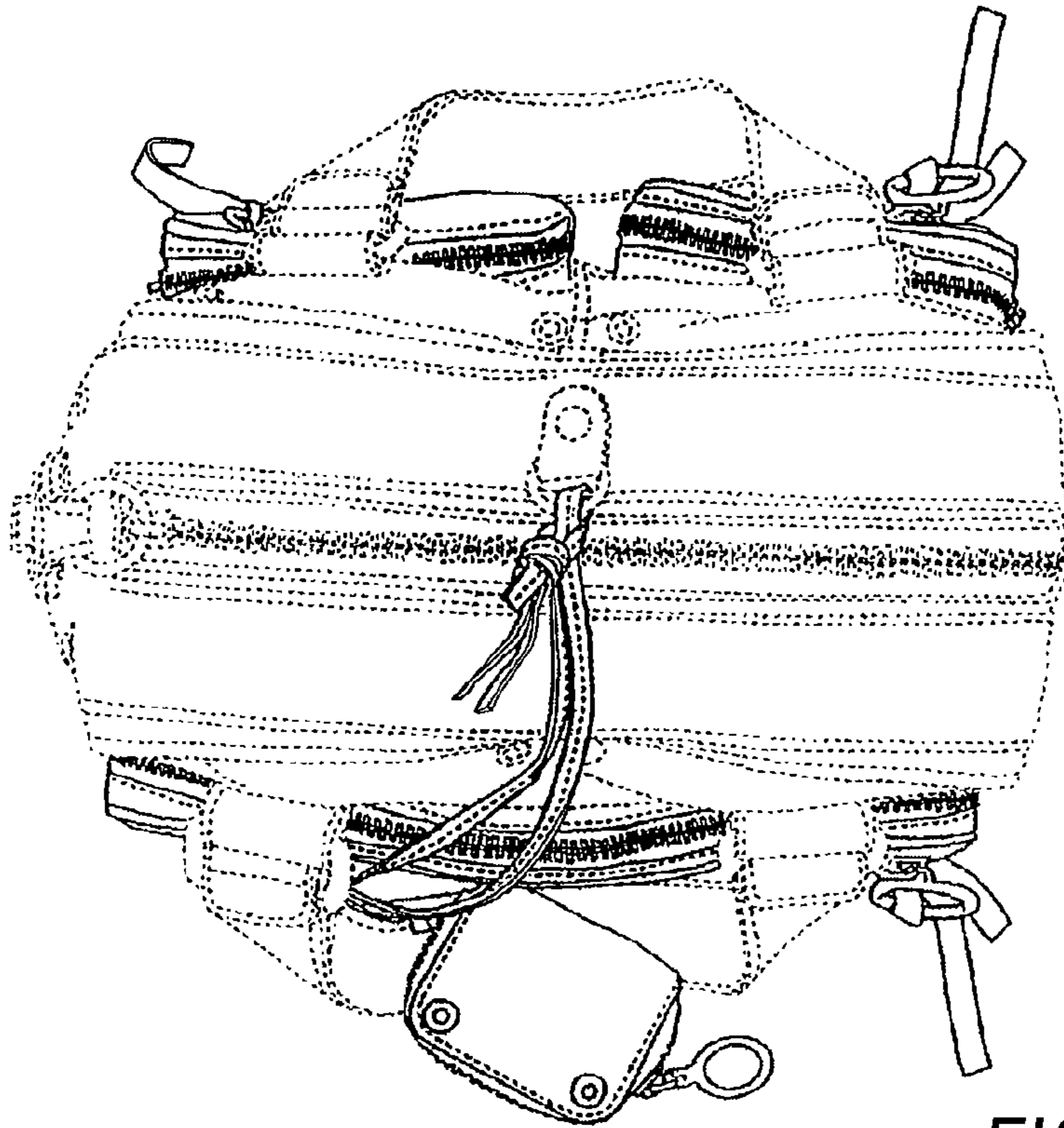

FIG. 3

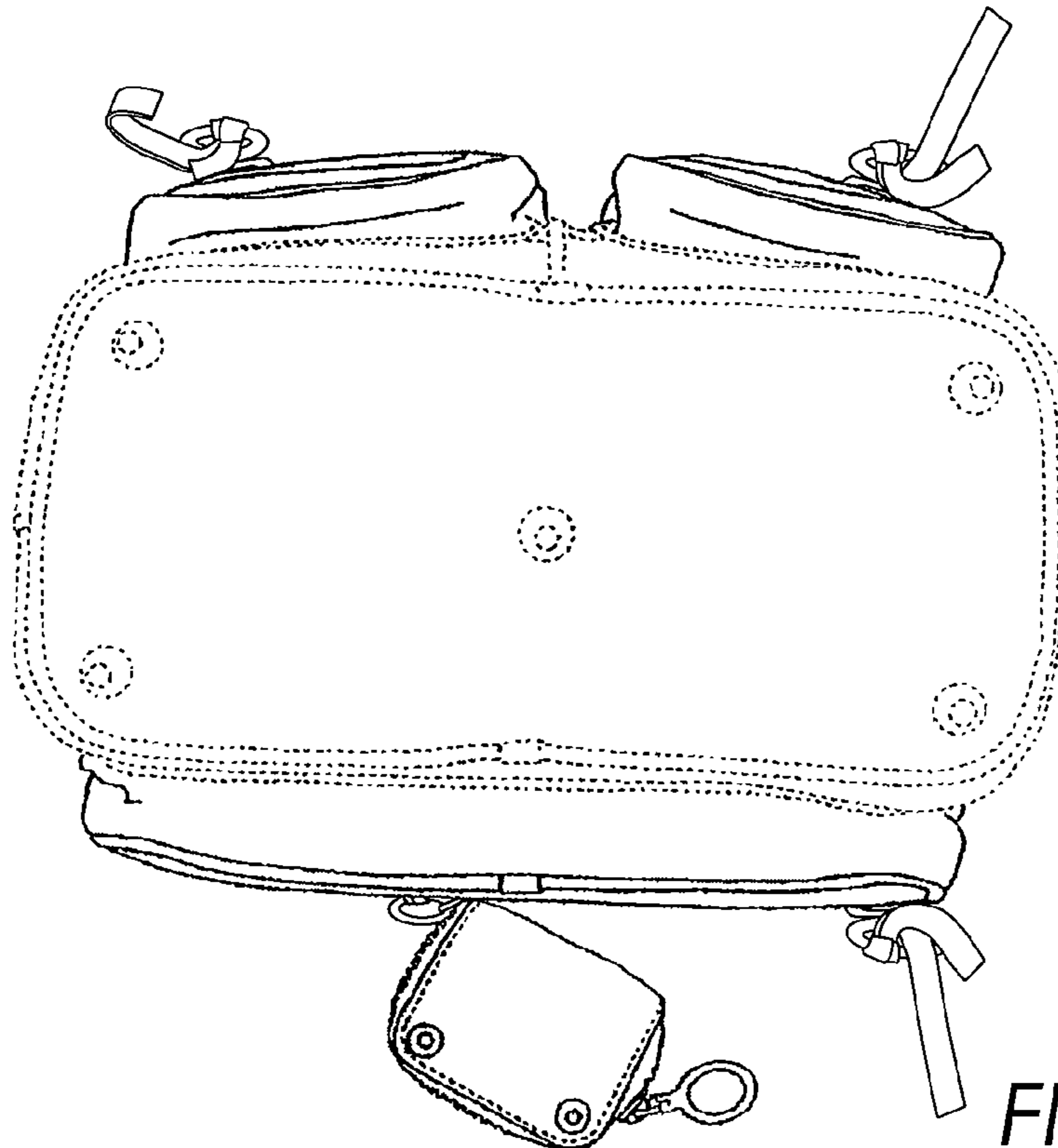

FIG. 4

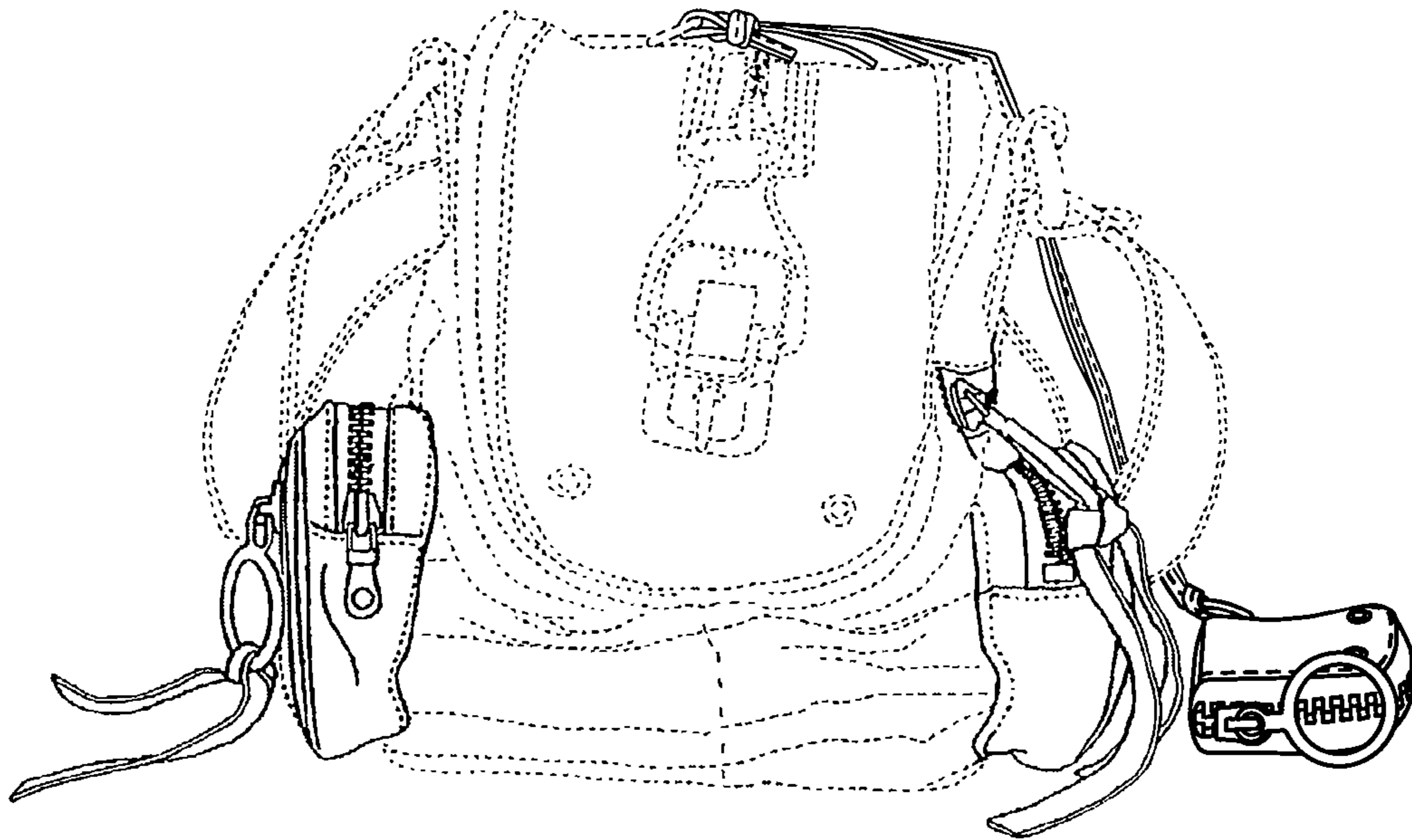

FIG. 5

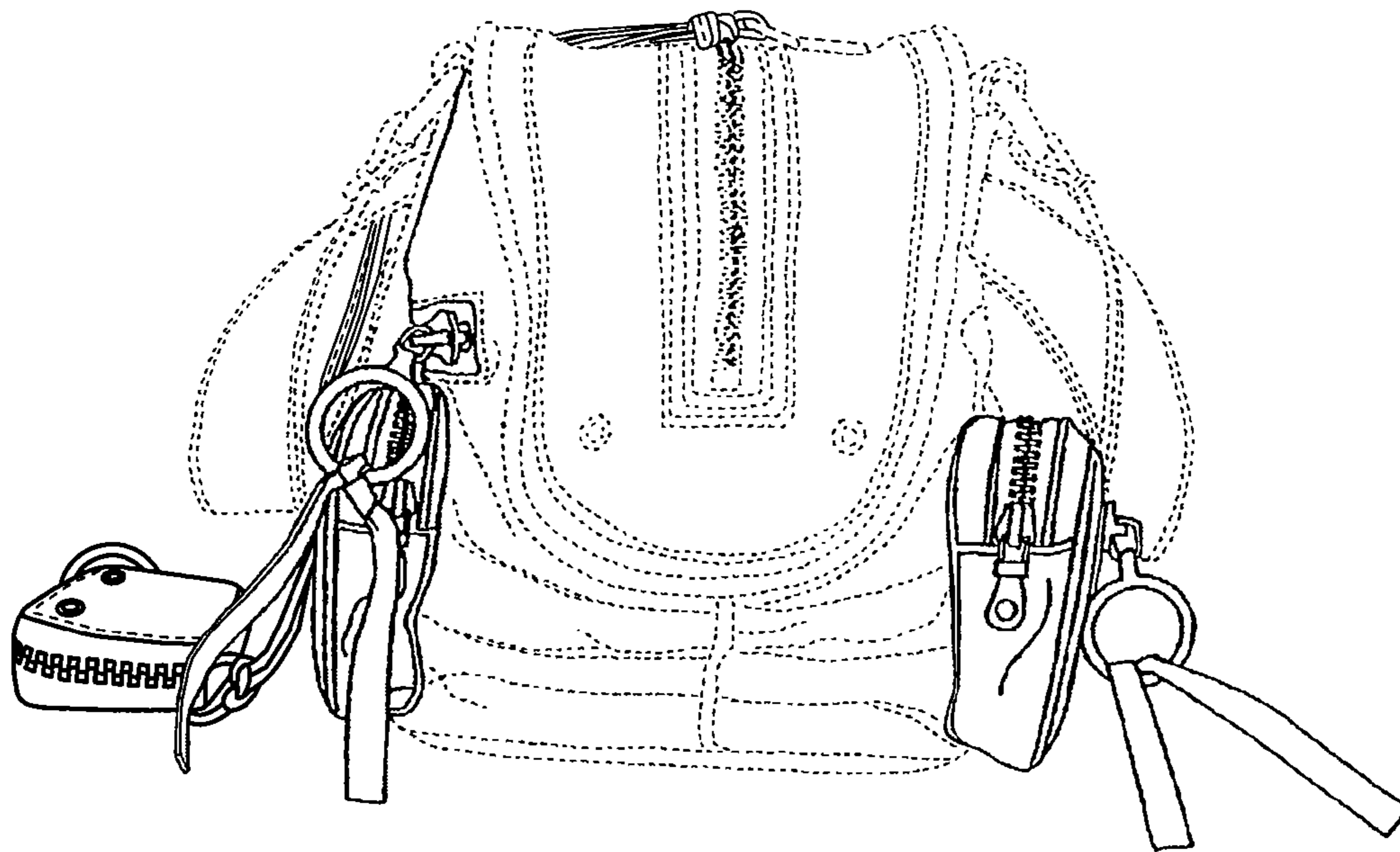

FIG. 6

Fig. 7



Fig. 8

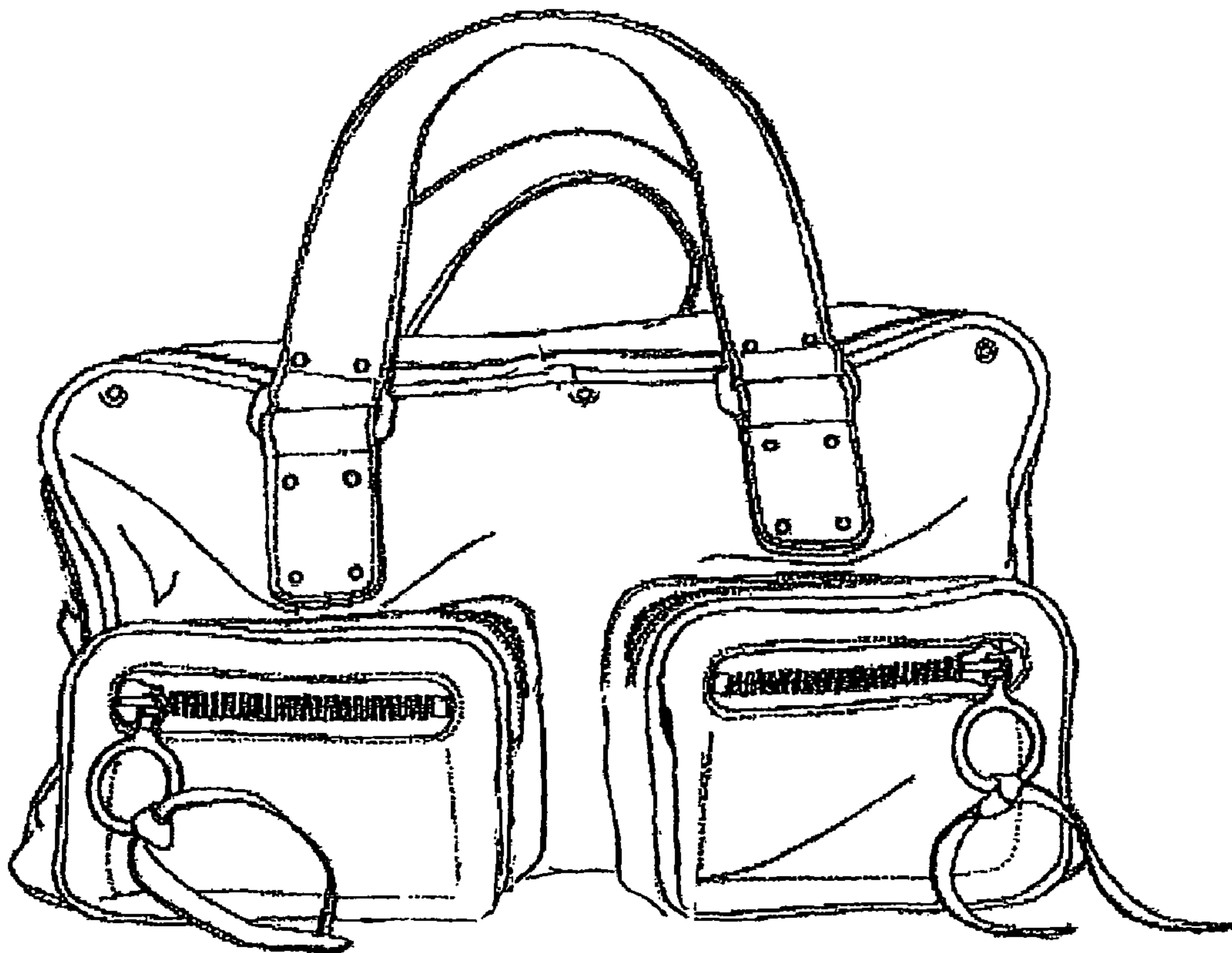

Fig. 9

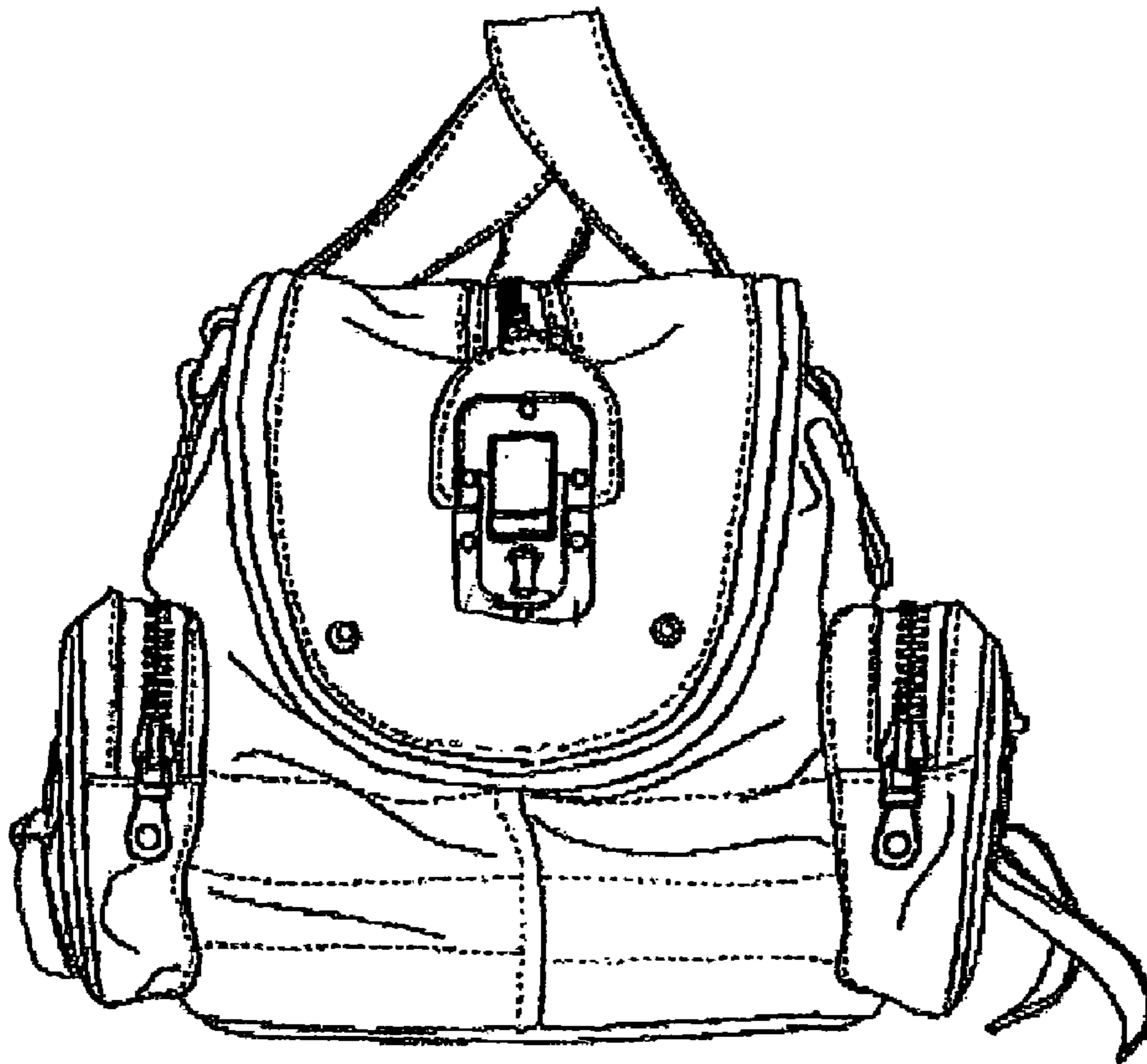

Fig. 10

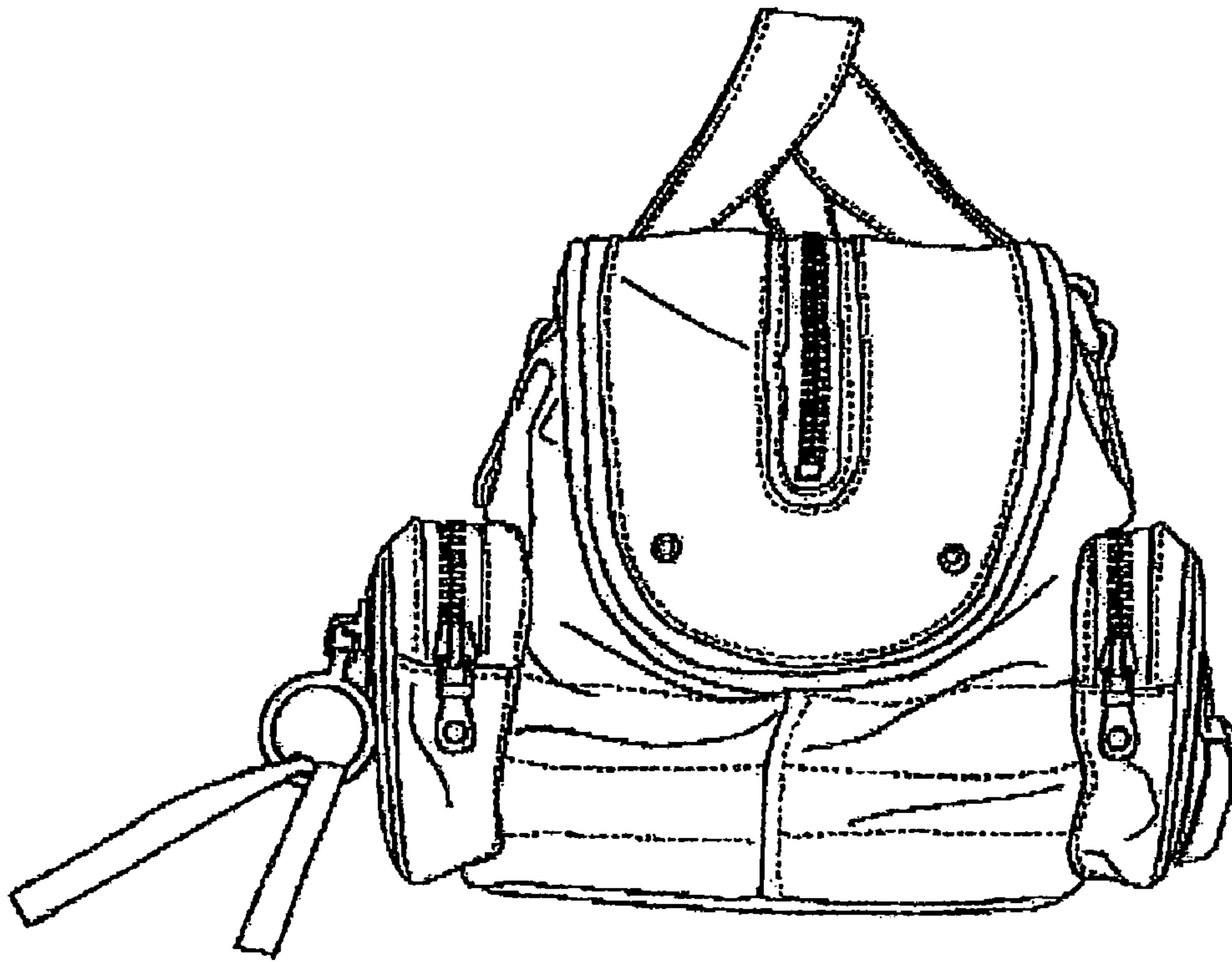

Fig. 11

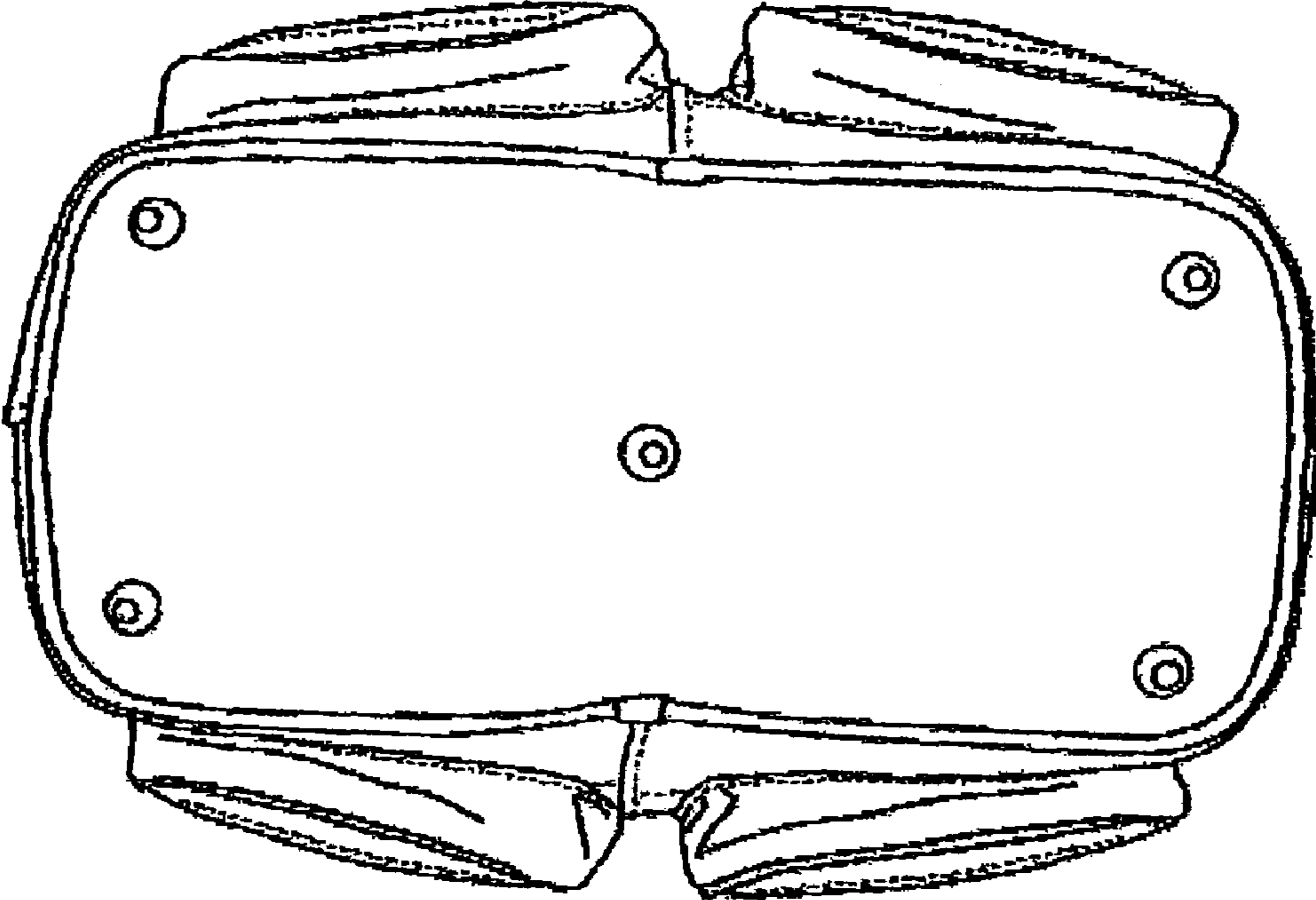

Fig. 12

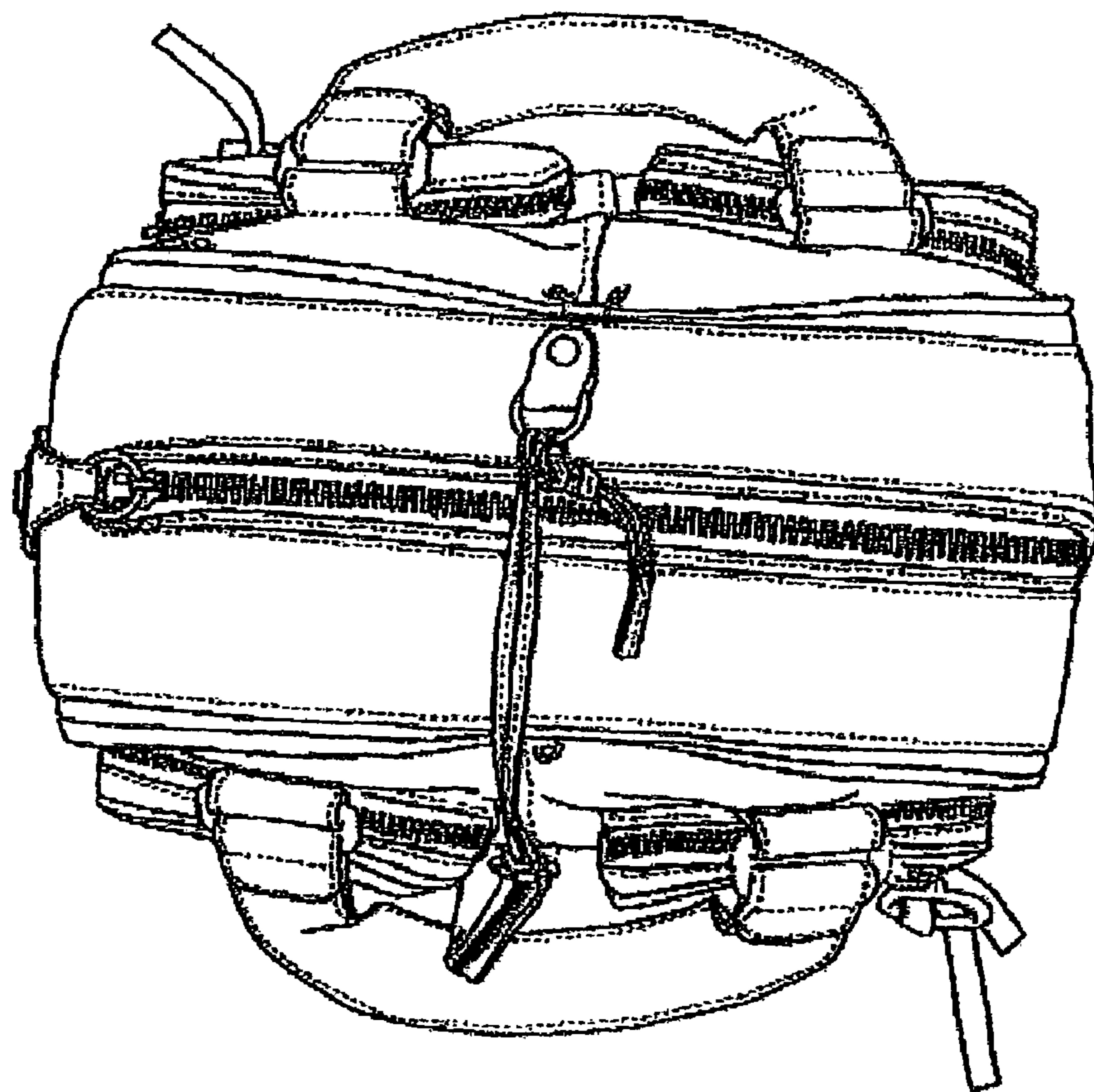

Fig. 13

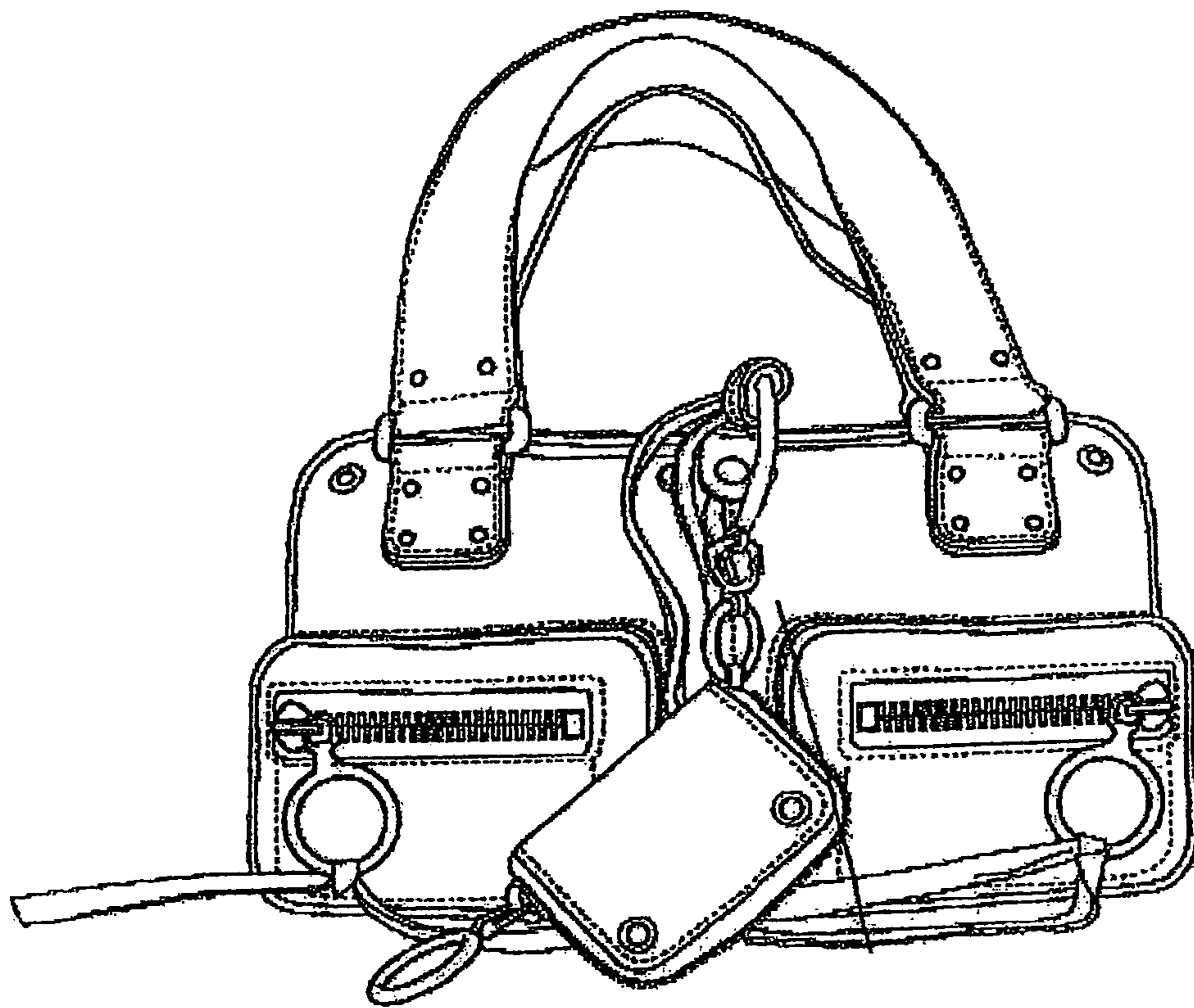

Fig. 14

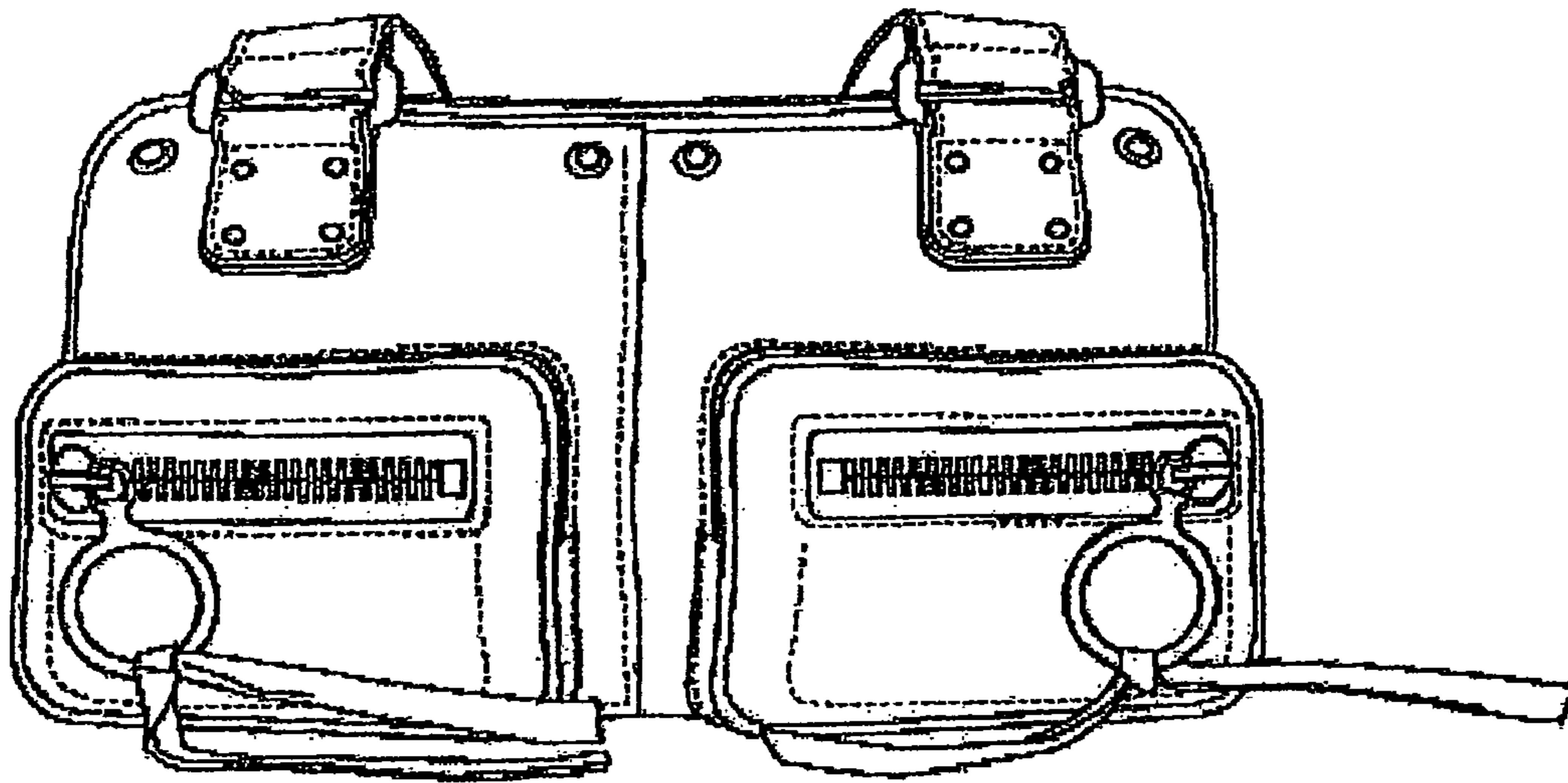

Fig. 15

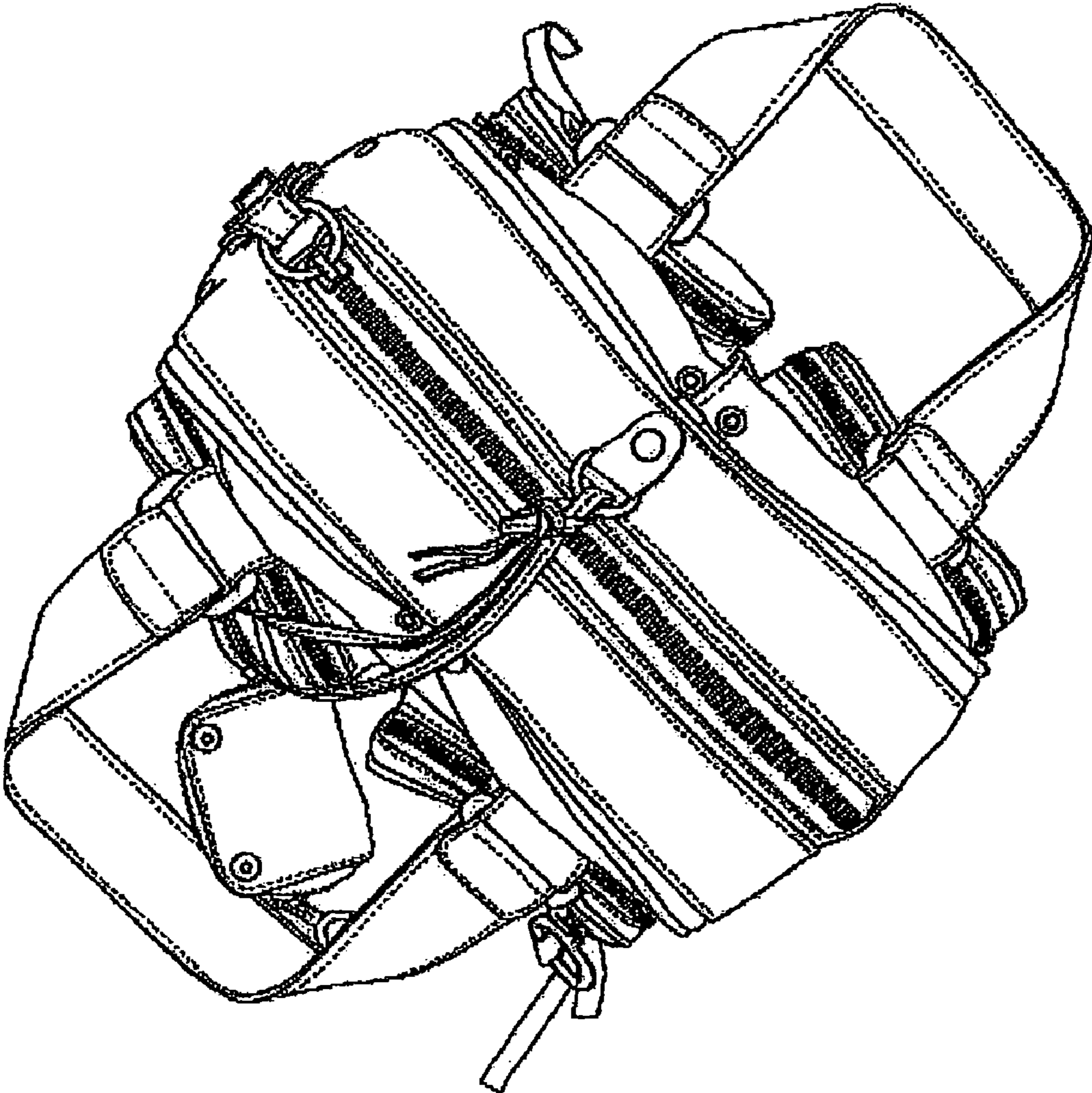

Fig. 16

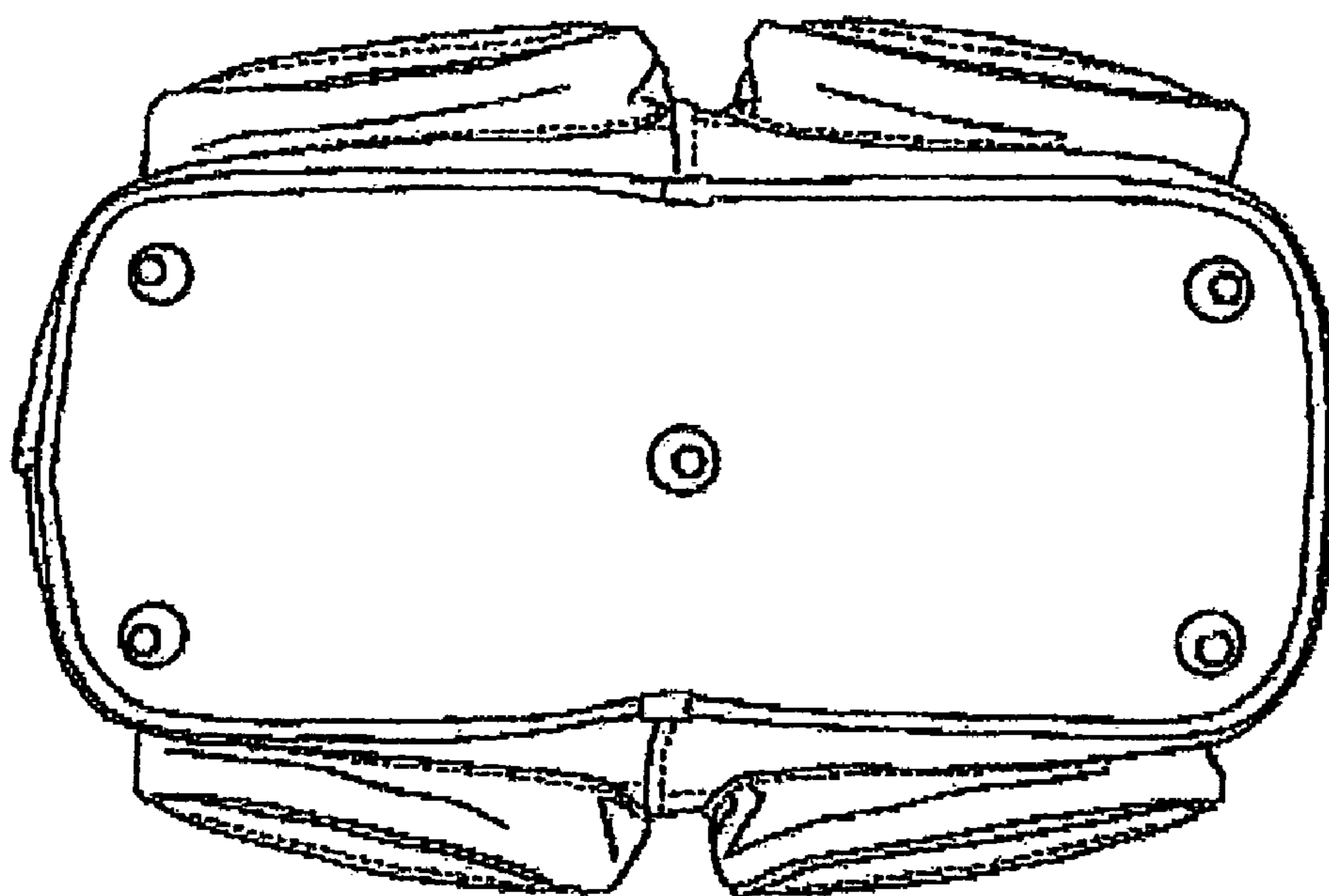

Fig. 17

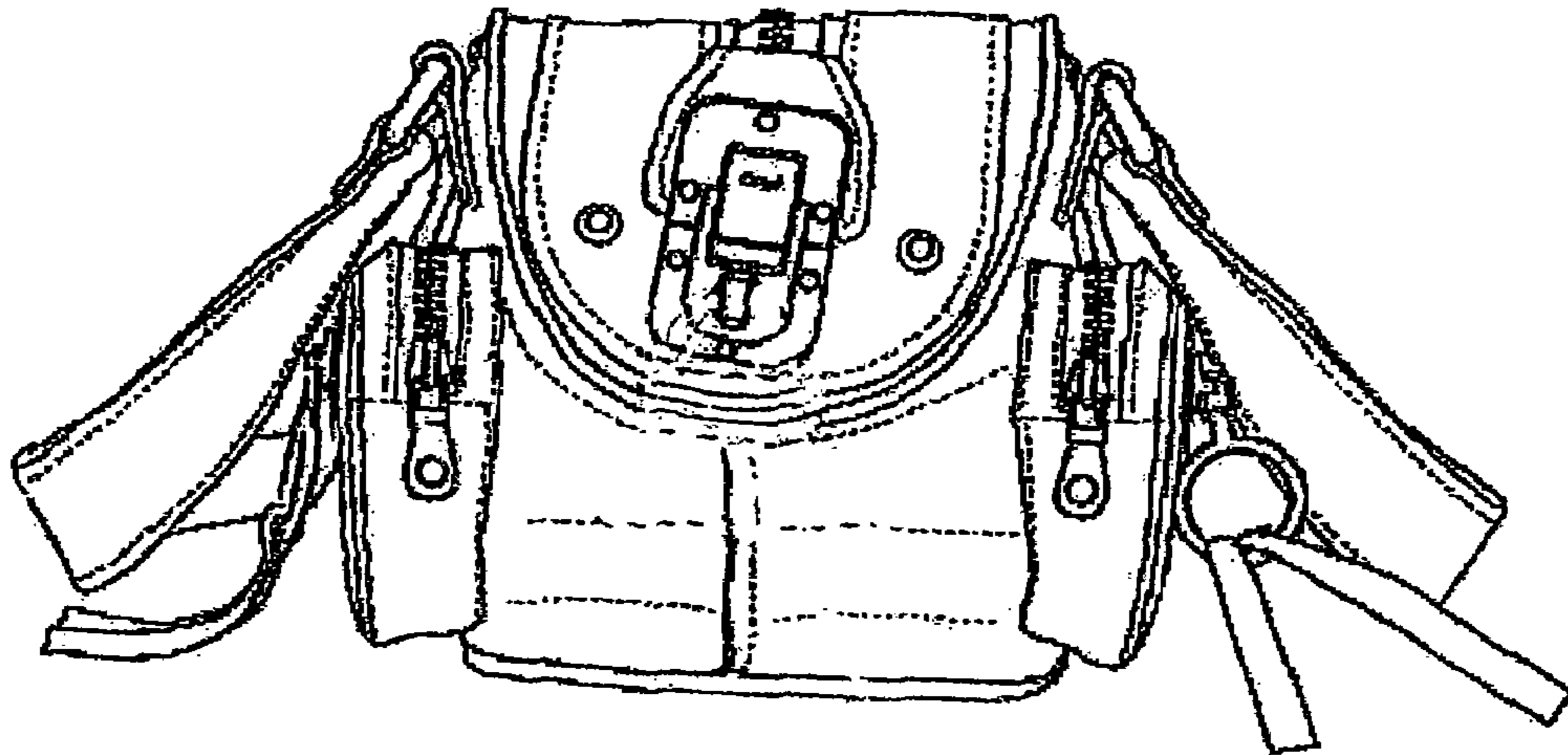

Fig. 18



Fig. 19

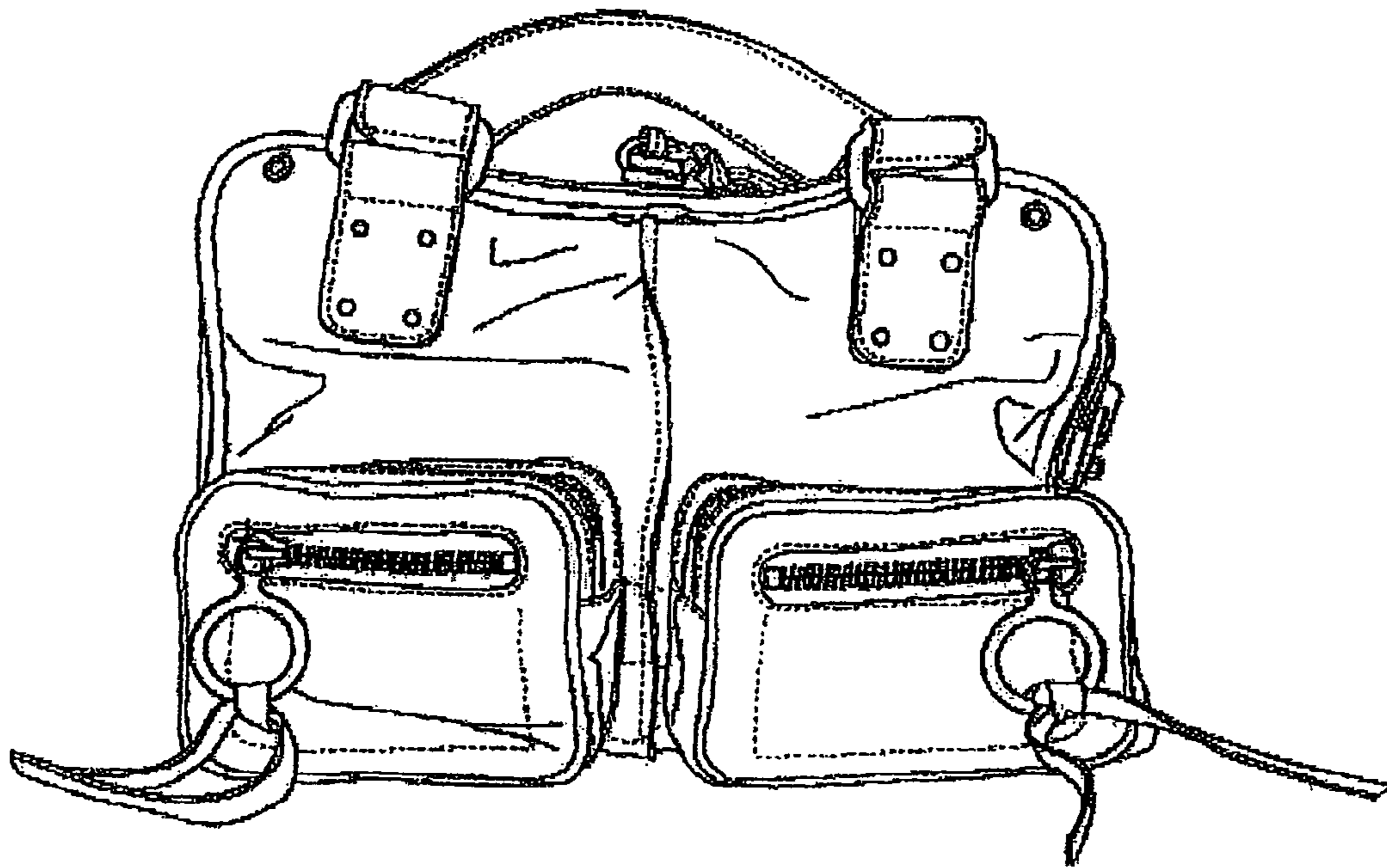

Fig. 20



Fig. 21

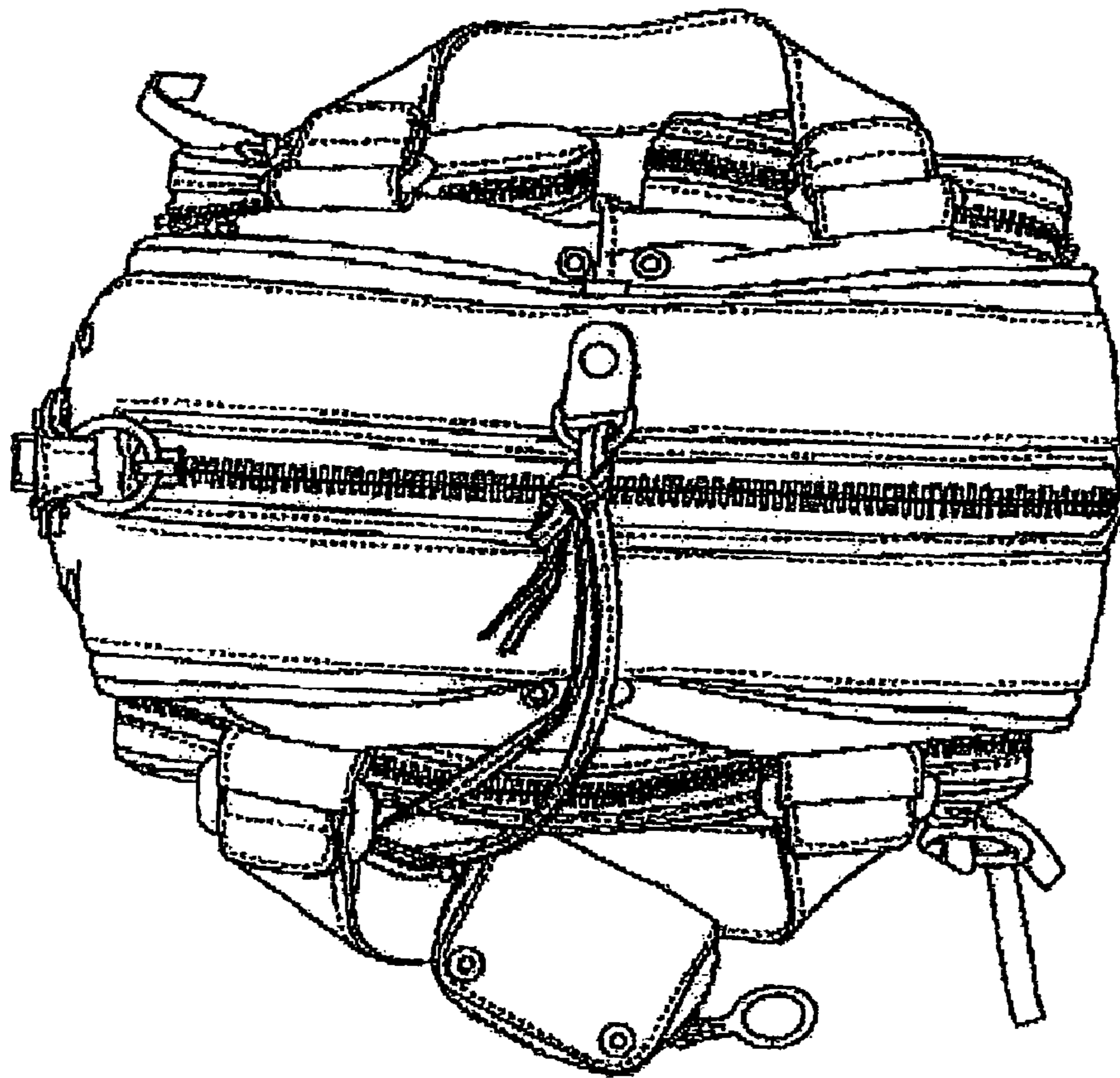

Fig. 22

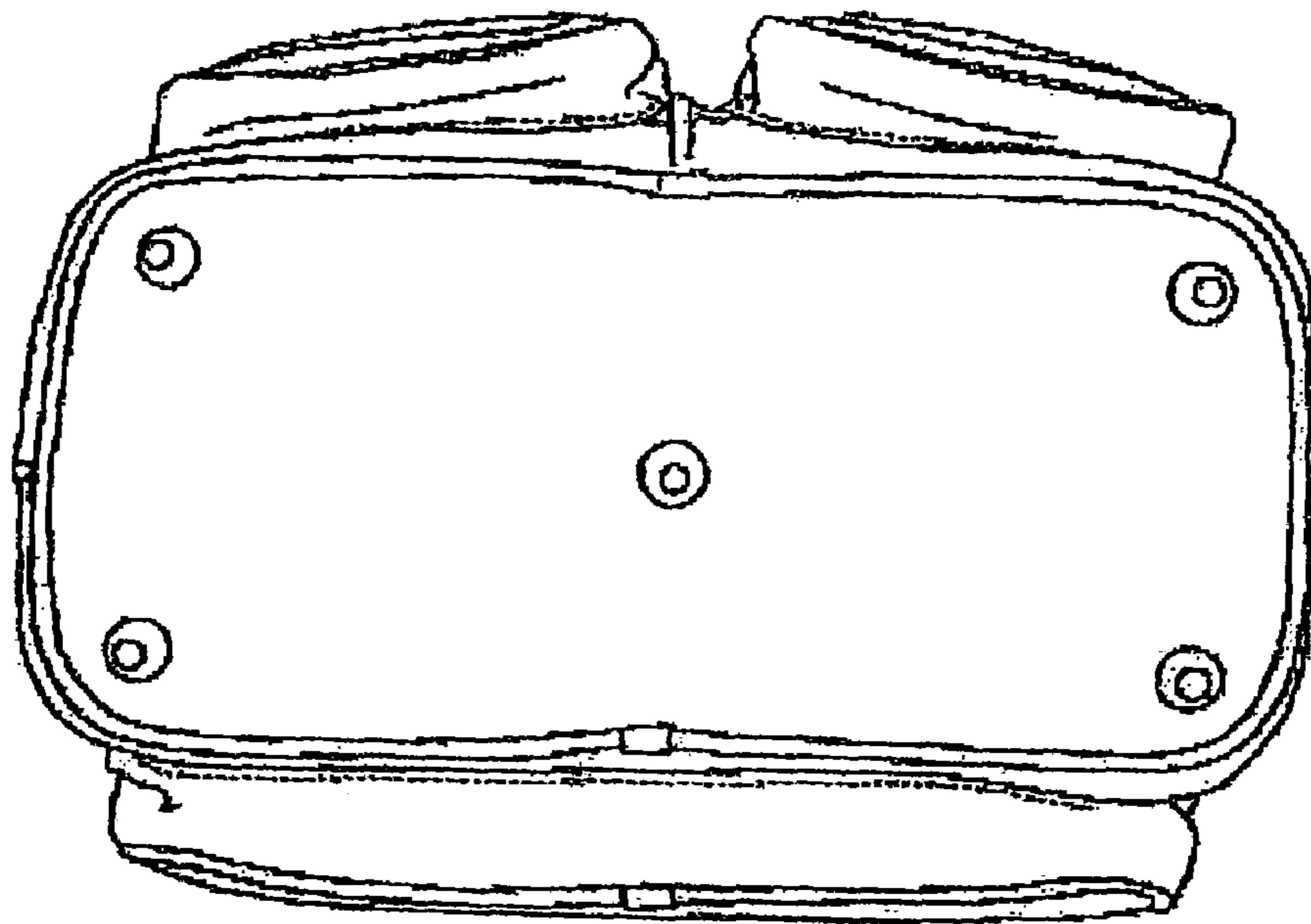

Fig. 23

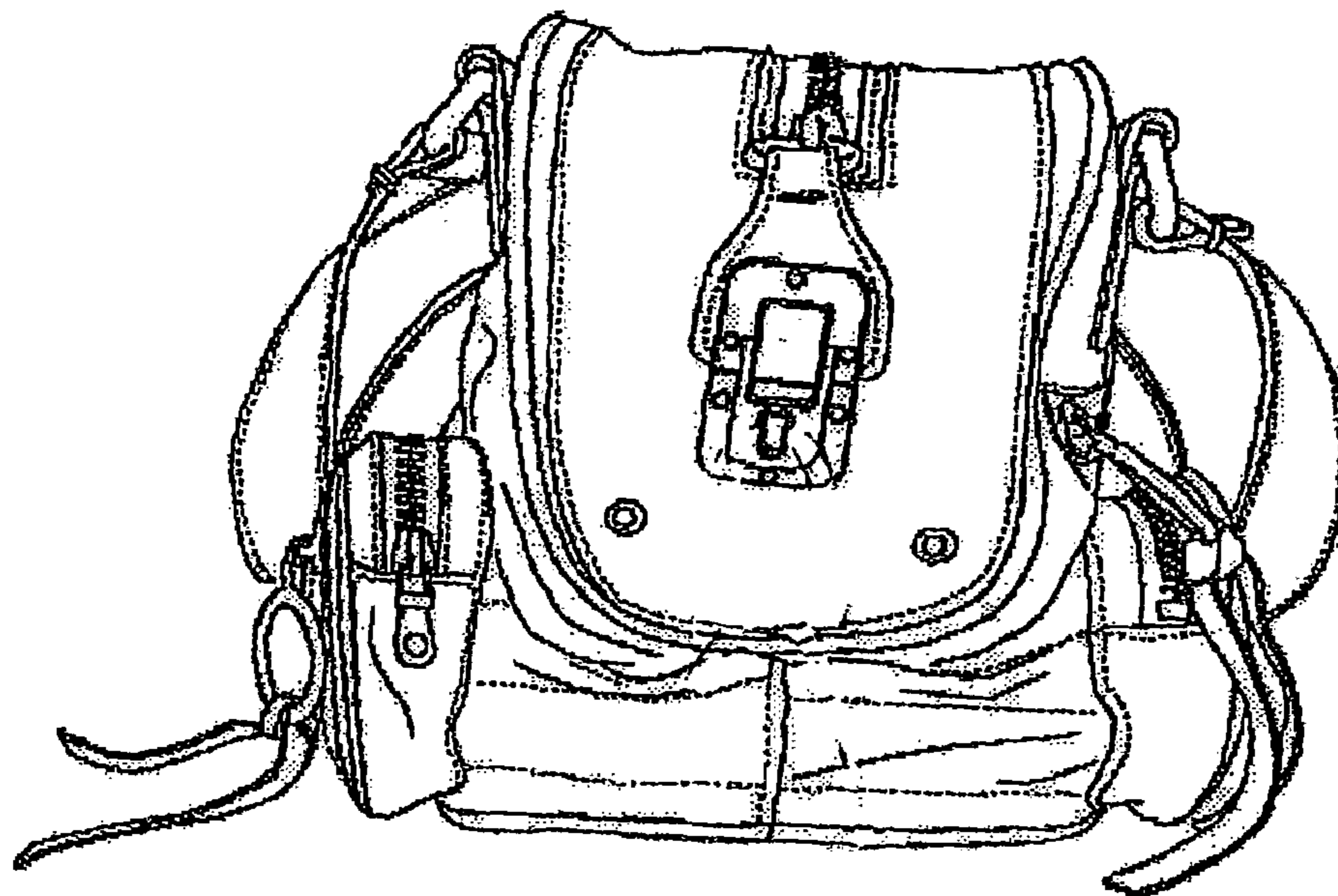

Fig. 24

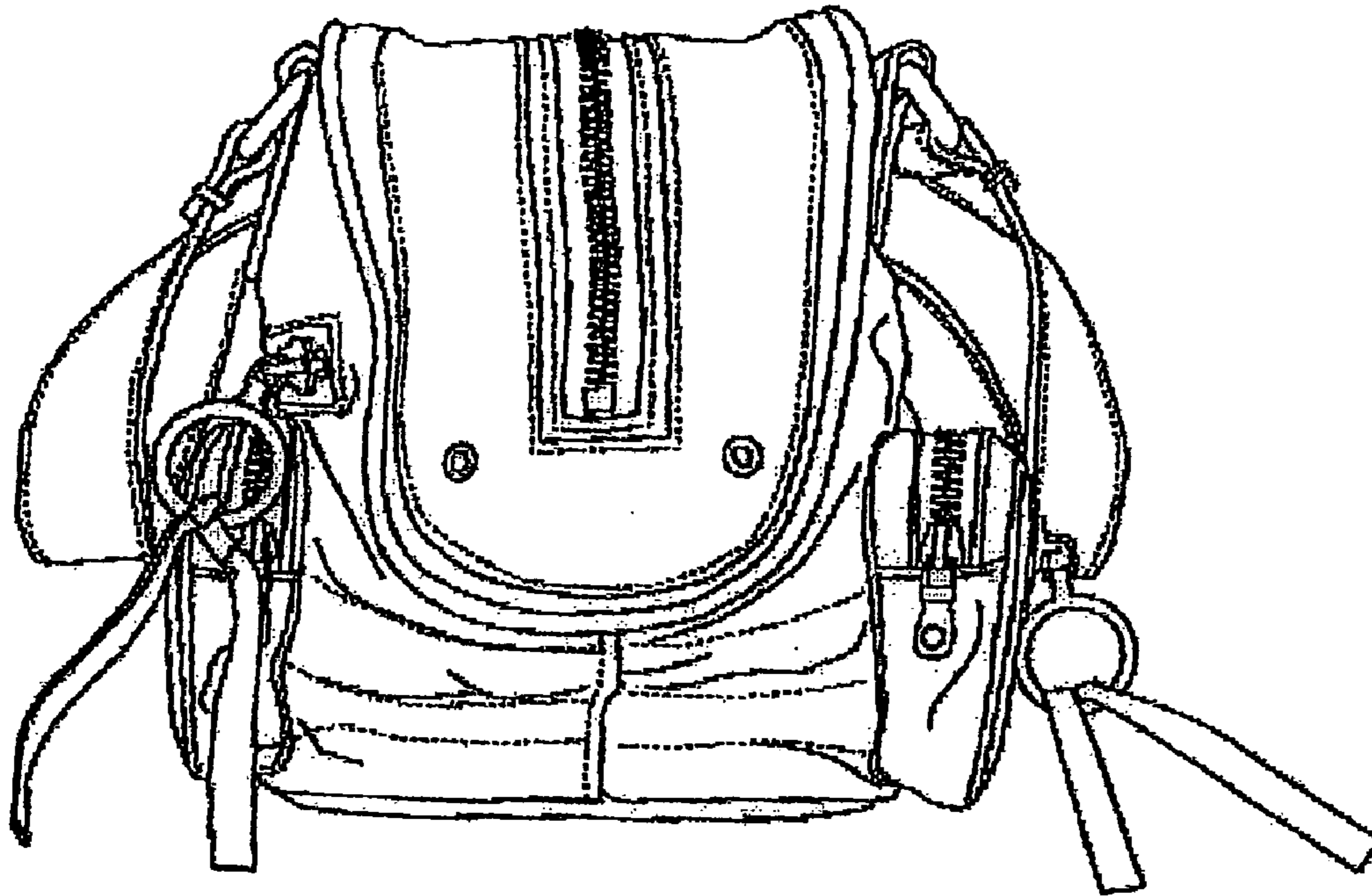

Fig. 25

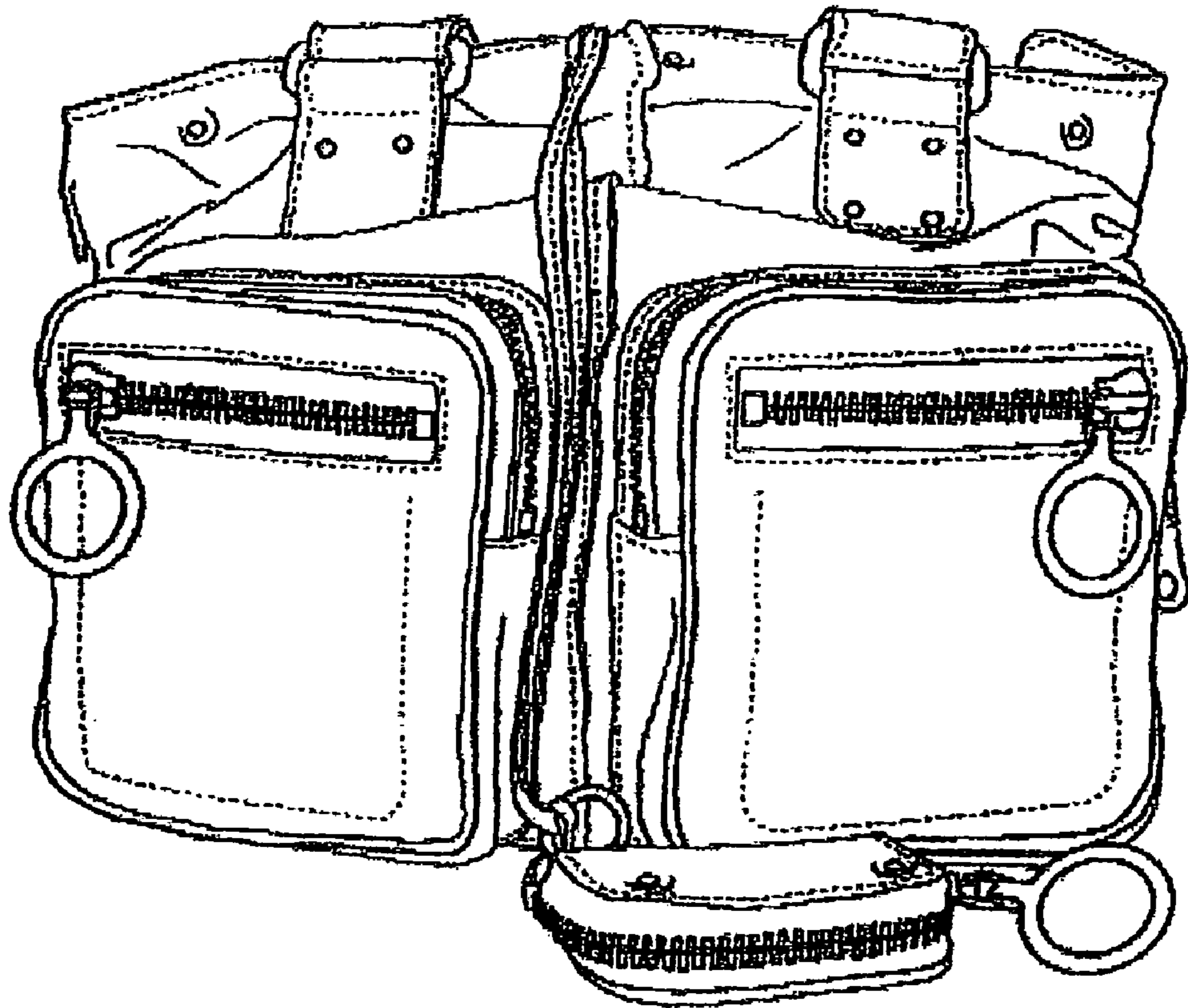

Fig. 26

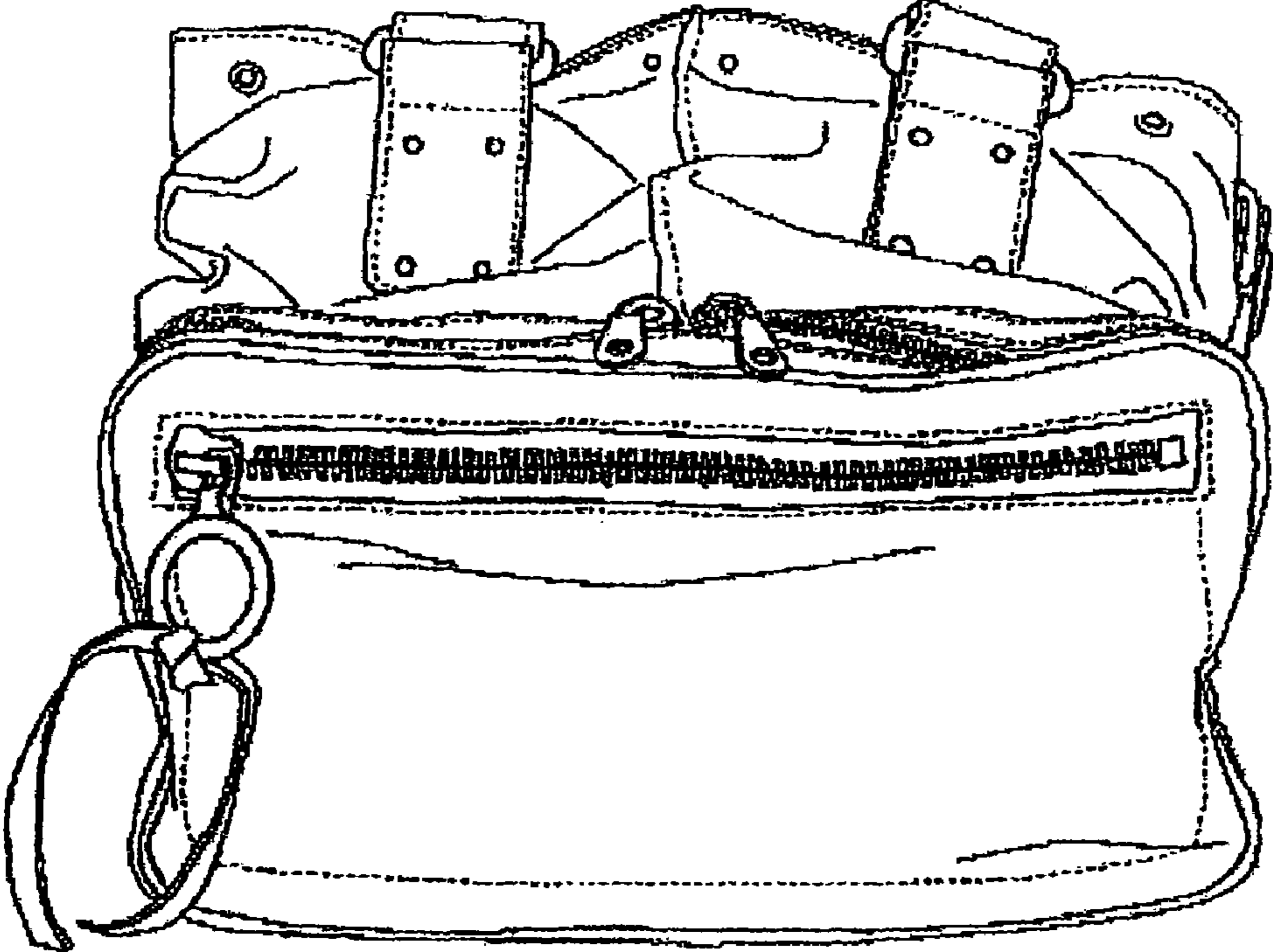

Fig. 27

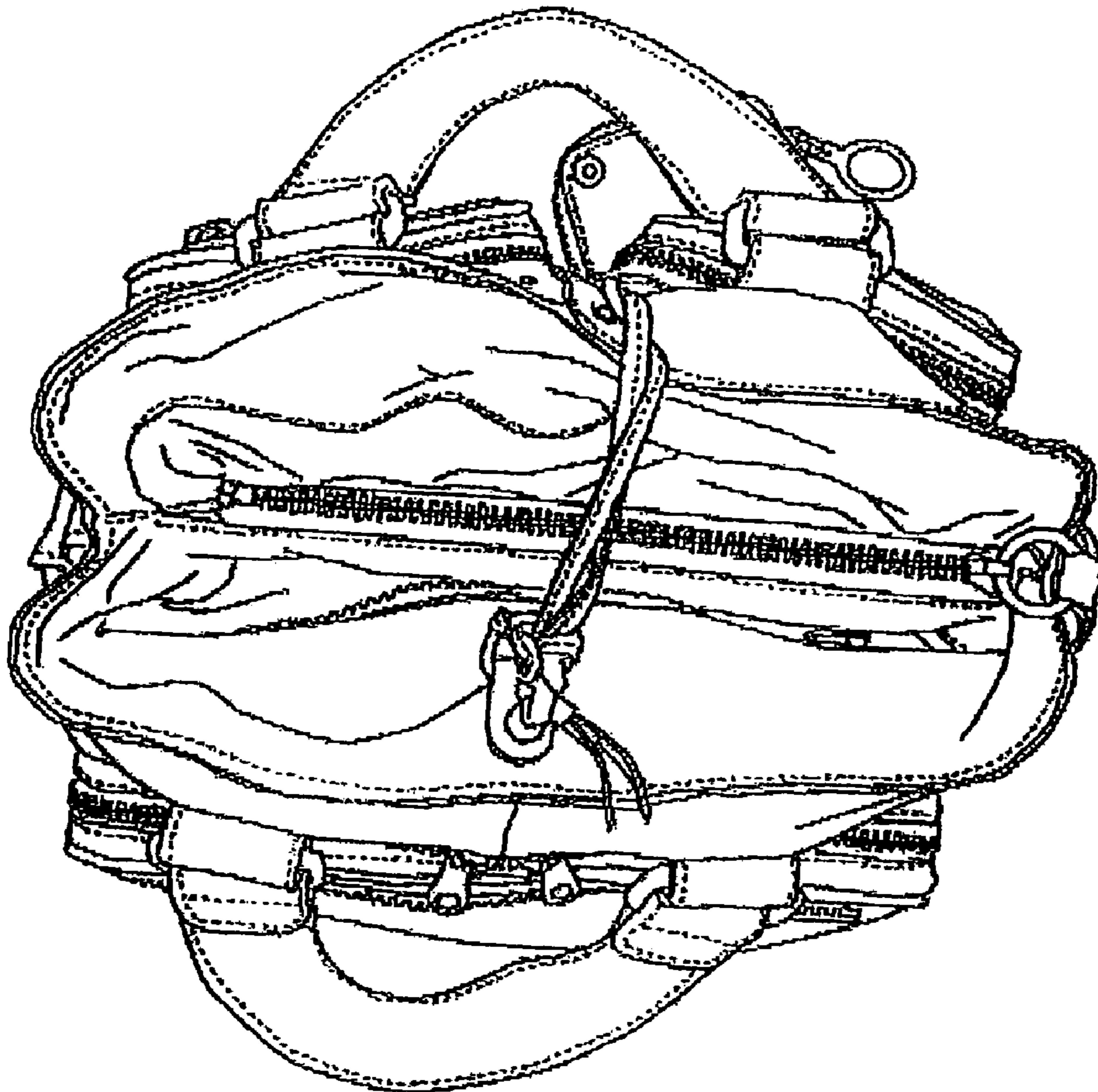

Fig. 27

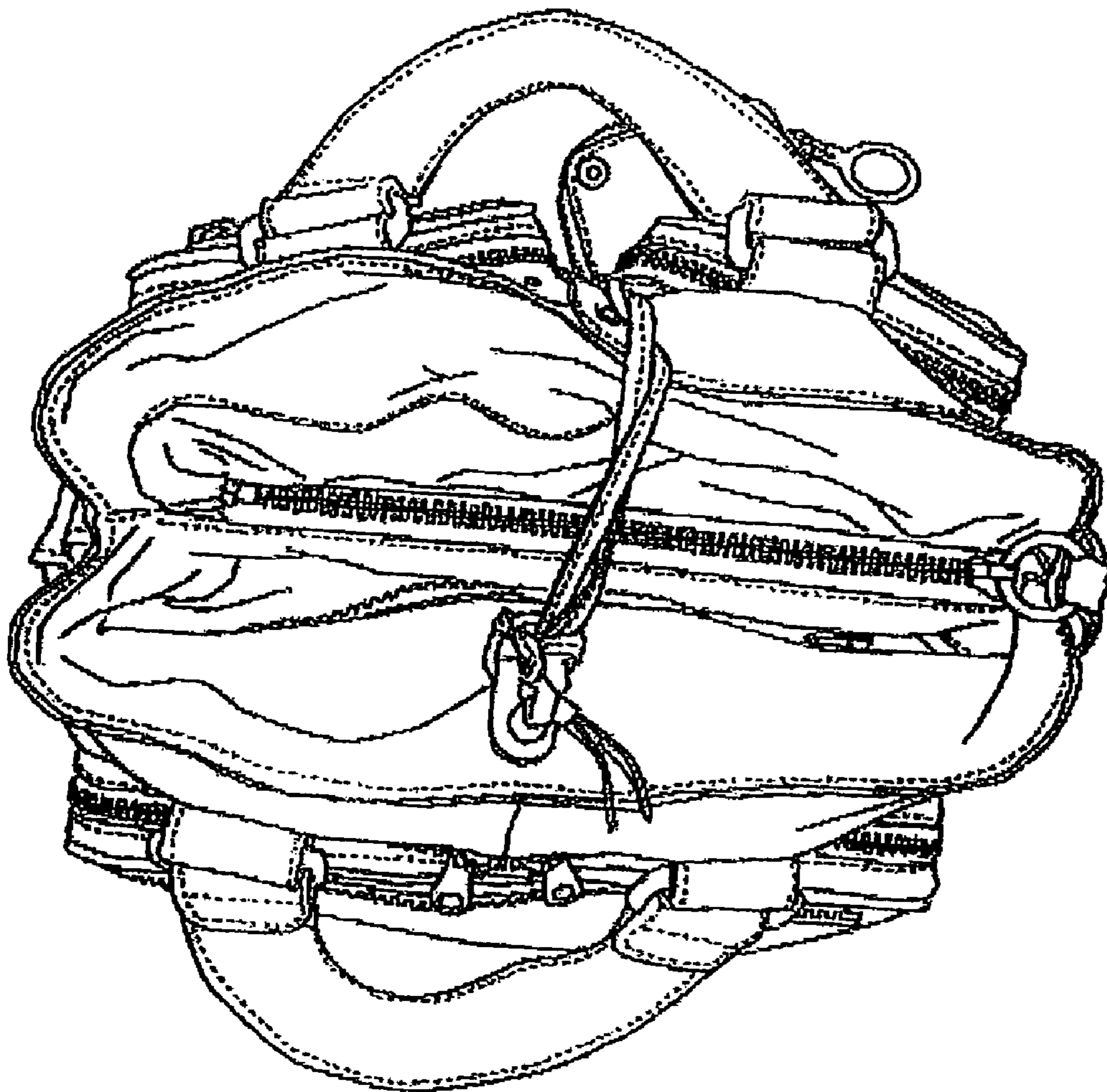

Fig. 28

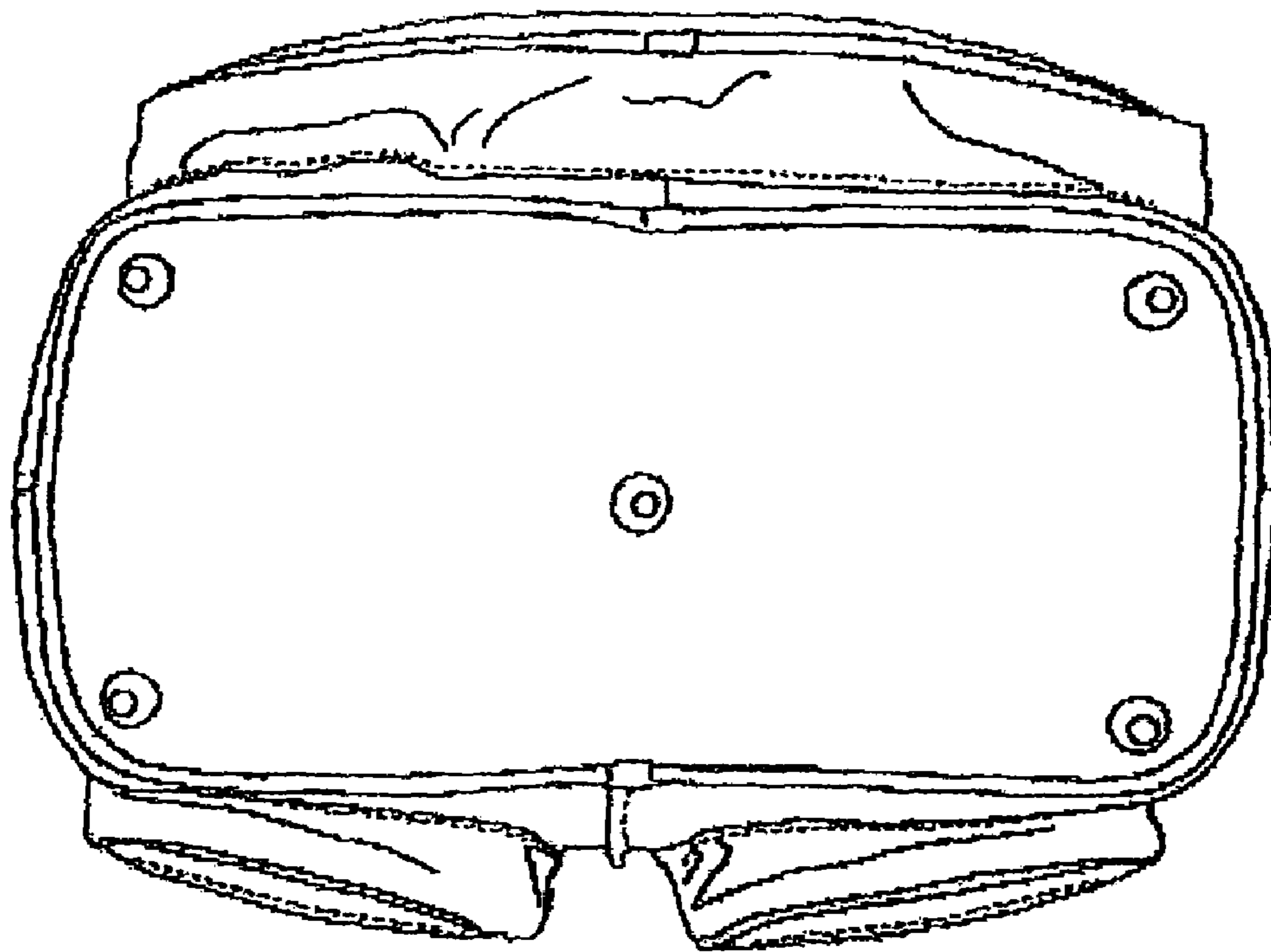

Fig. 29

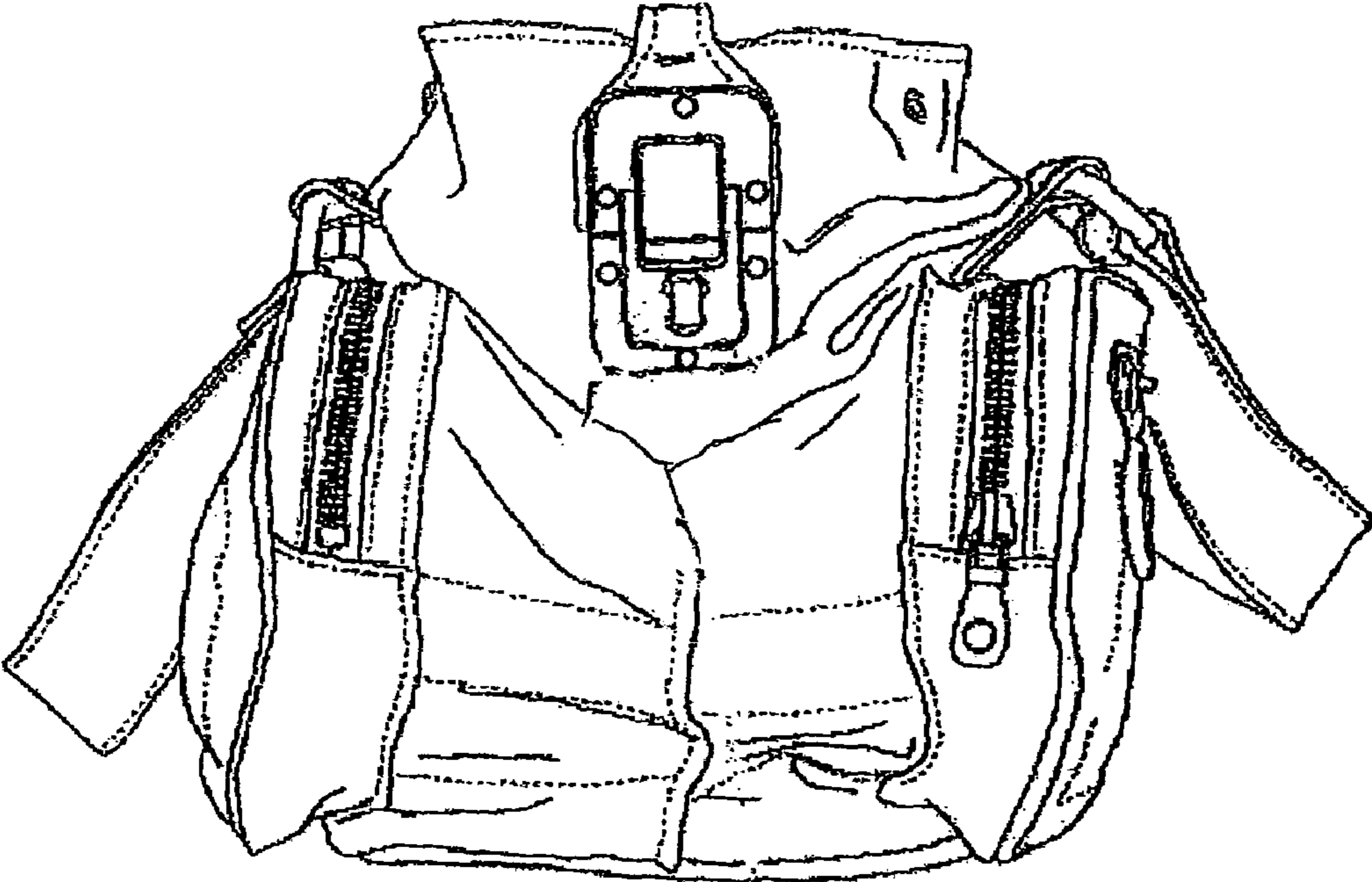

Fig. 30



Fig. 31

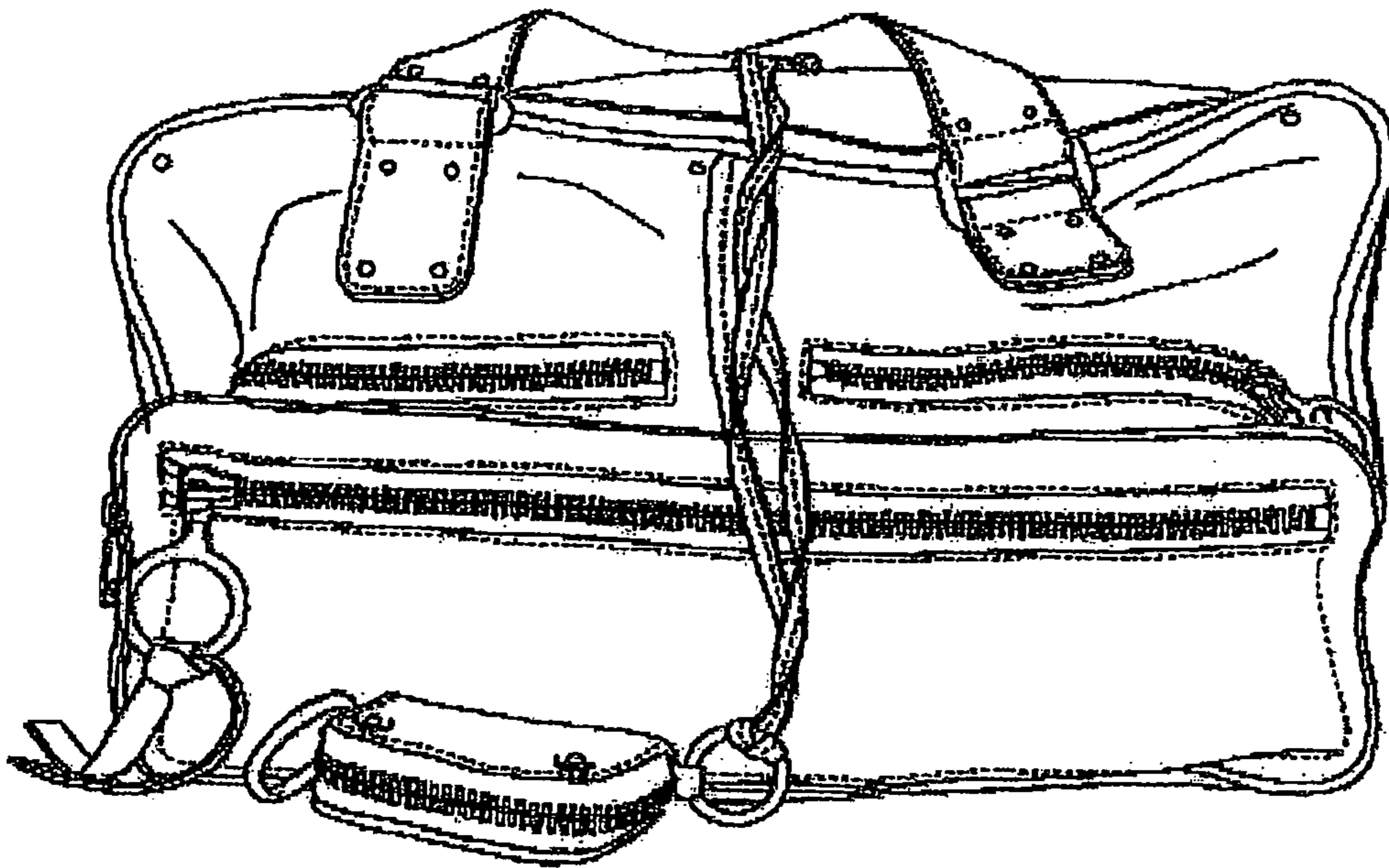

Fig. 32

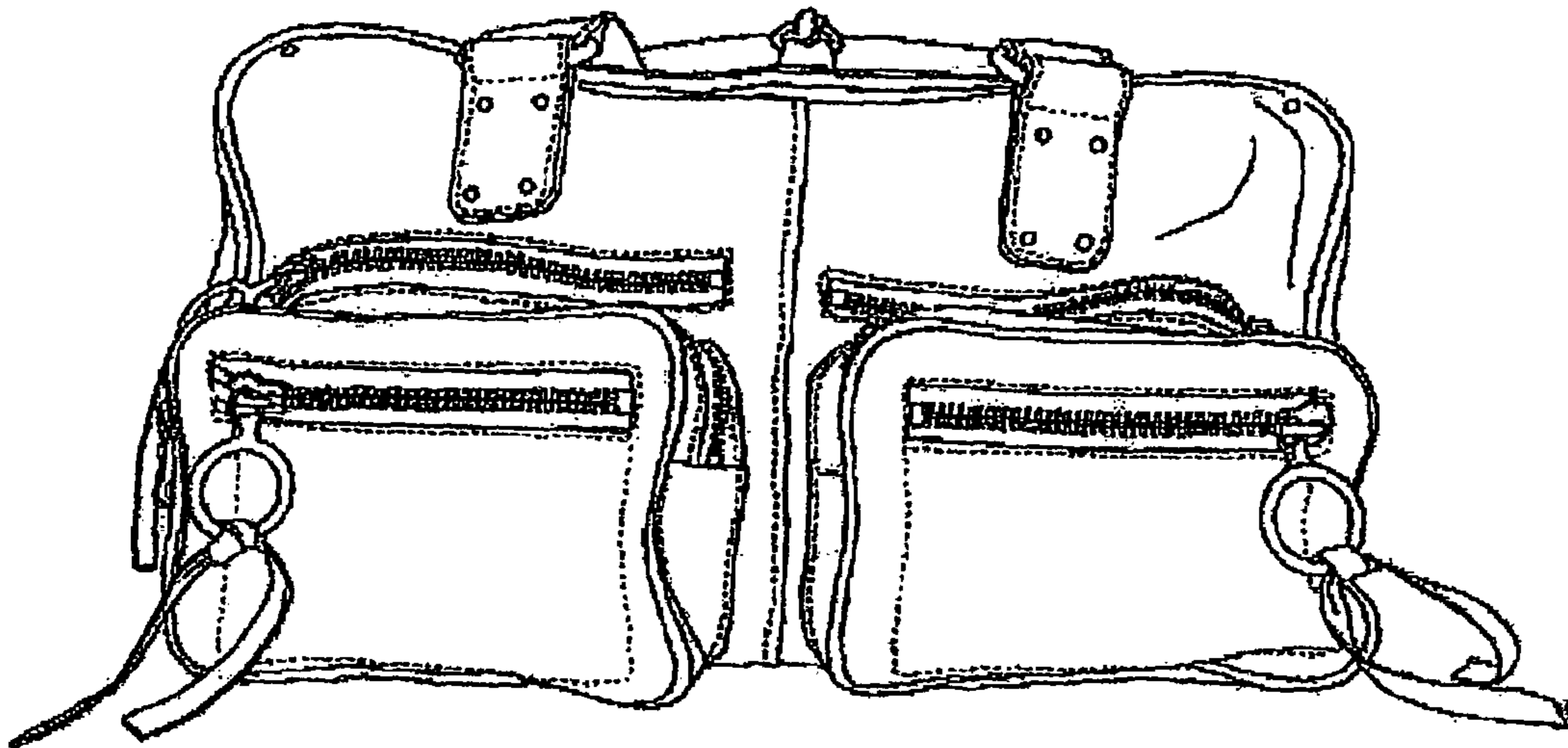

Fig. 33

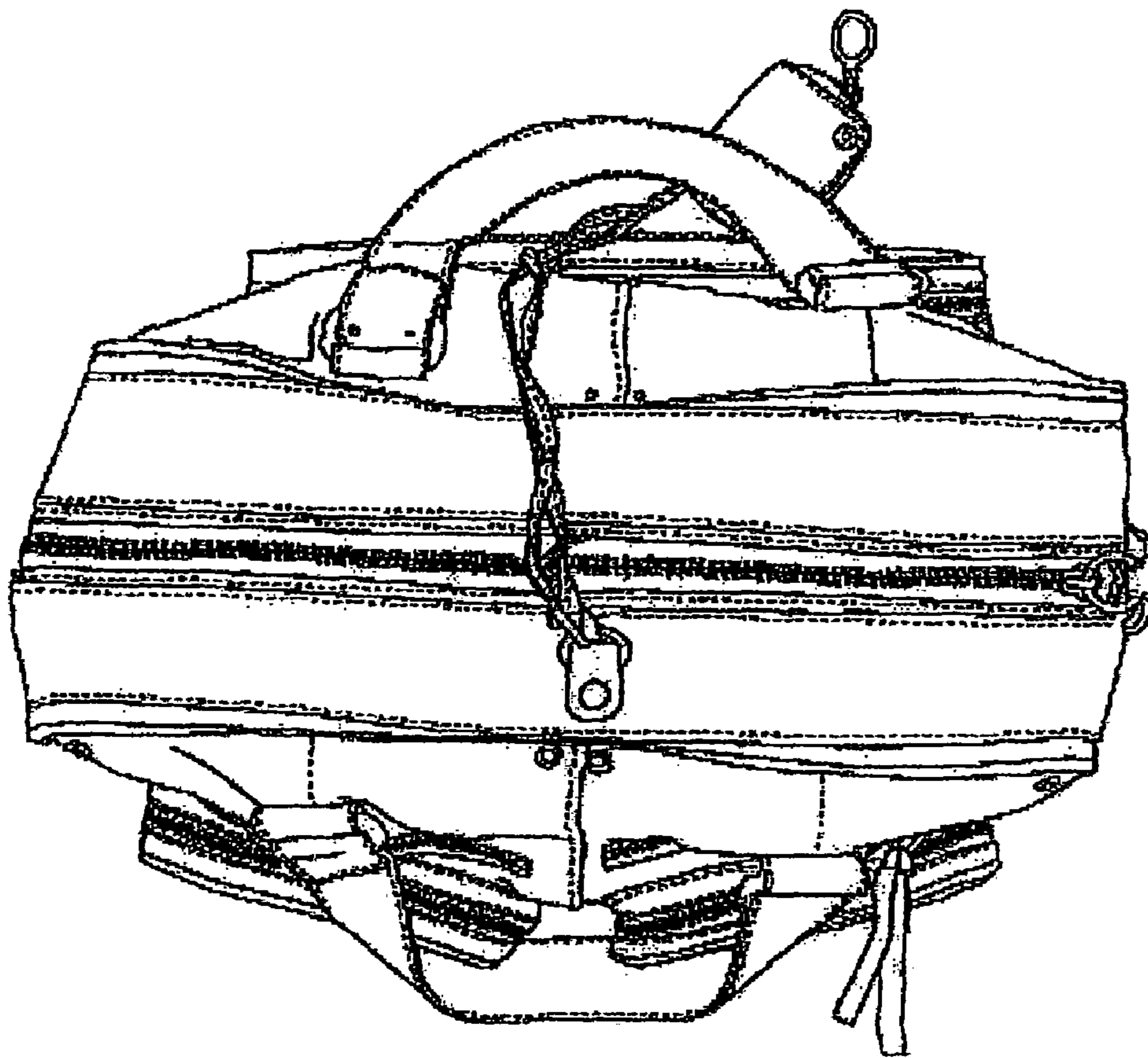

Fig. 34

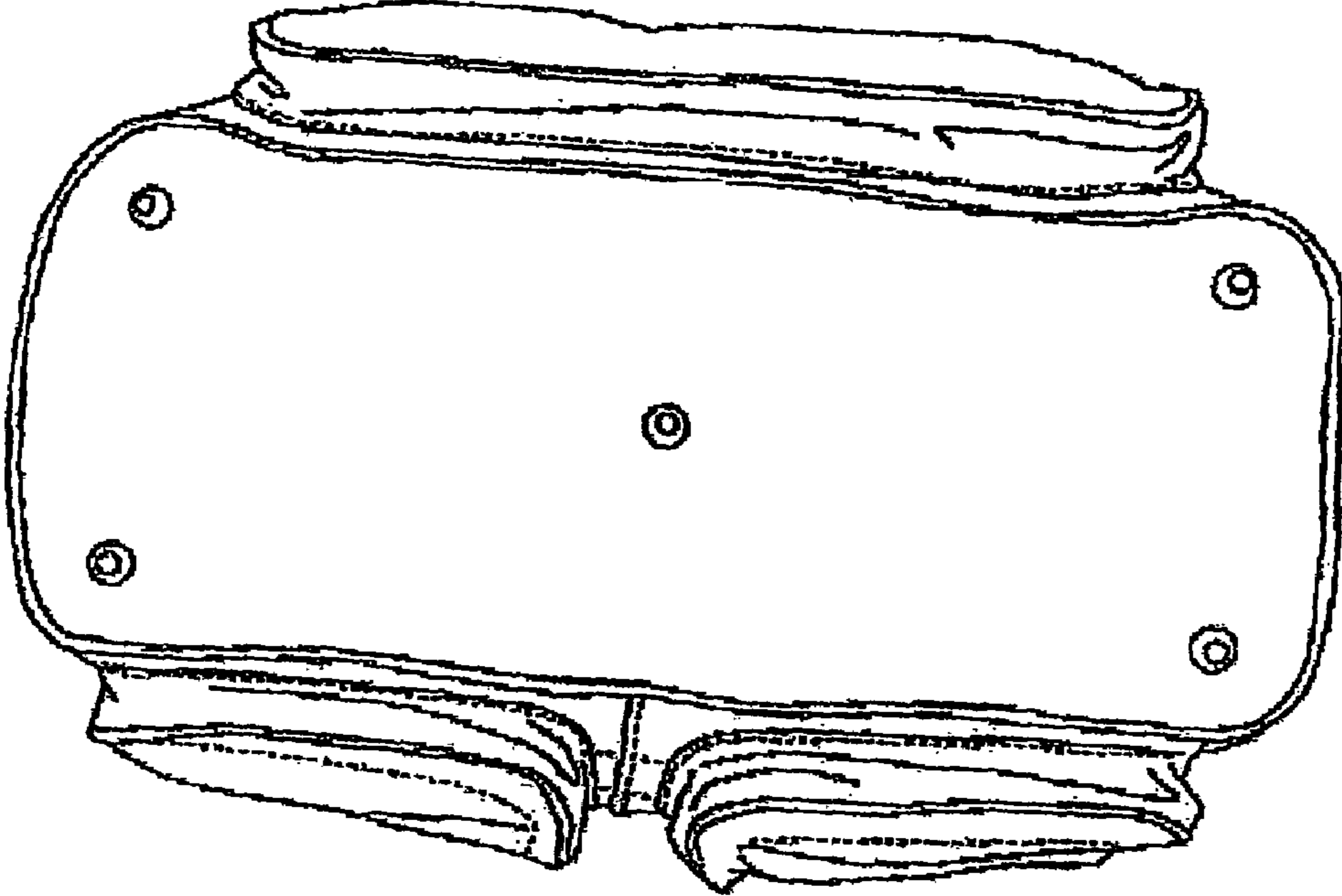

Fig. 35

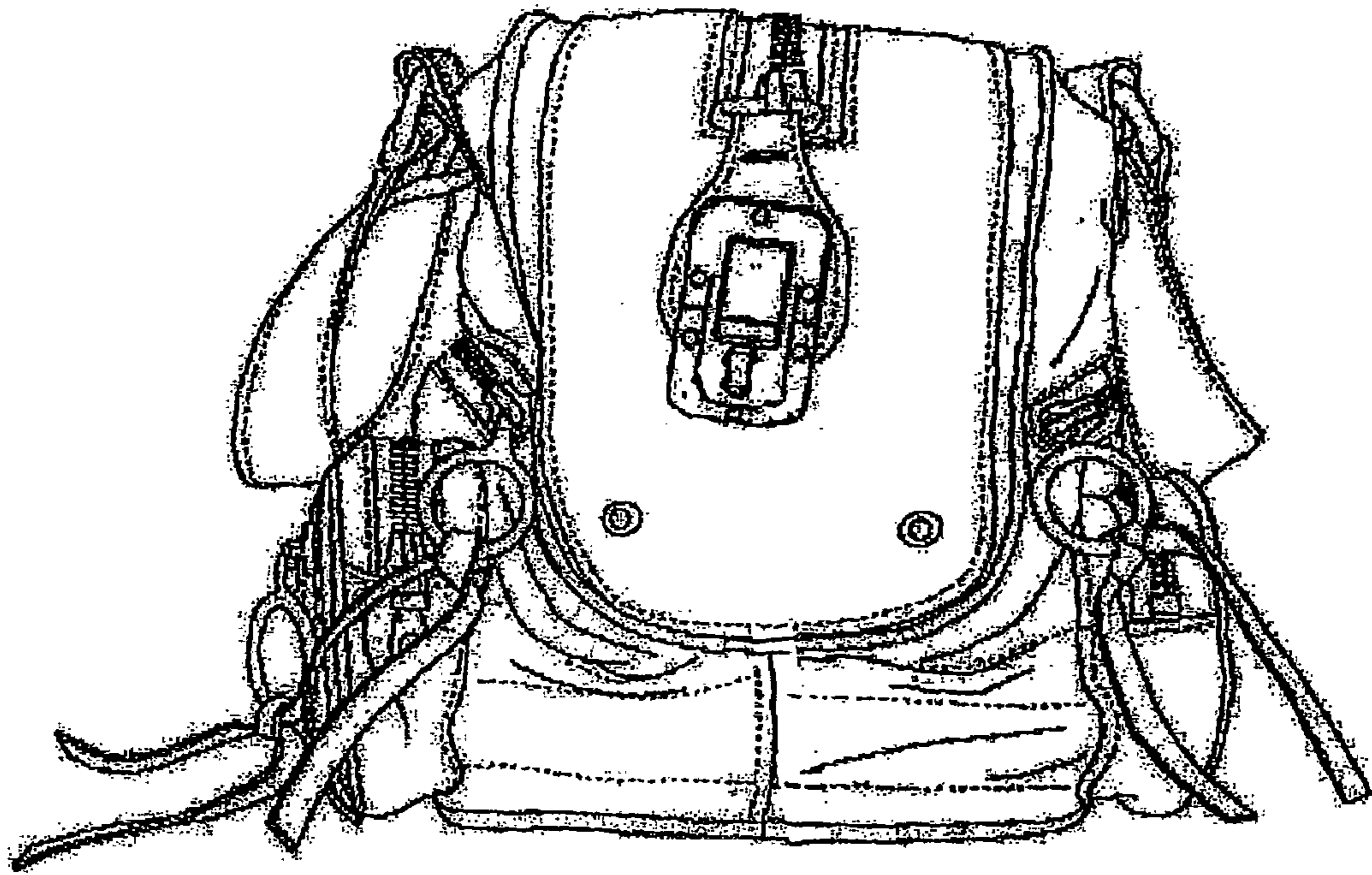

Fig. 36

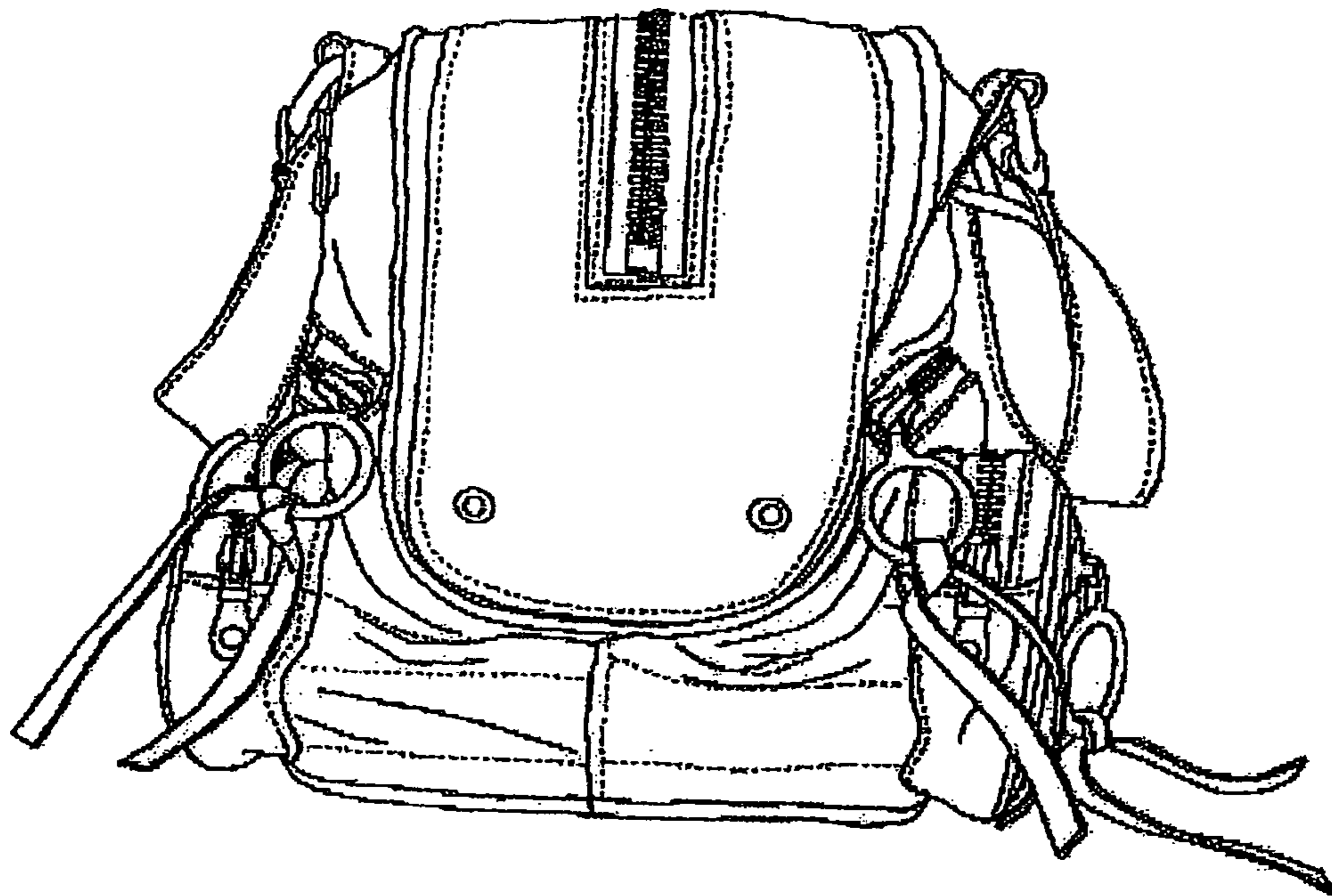

Fig. 37



Fig. 38

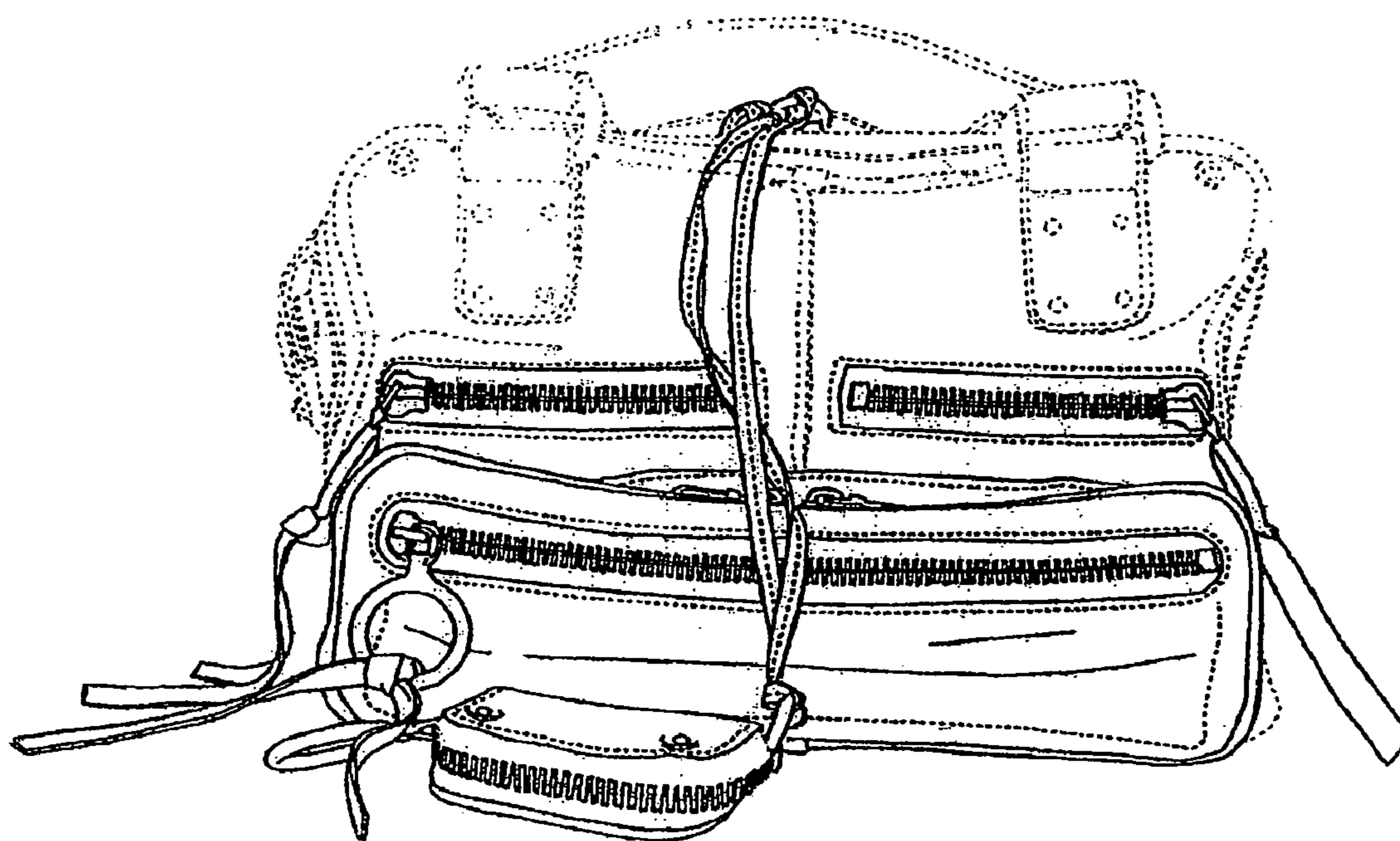

Fig. 39



Fig. 40

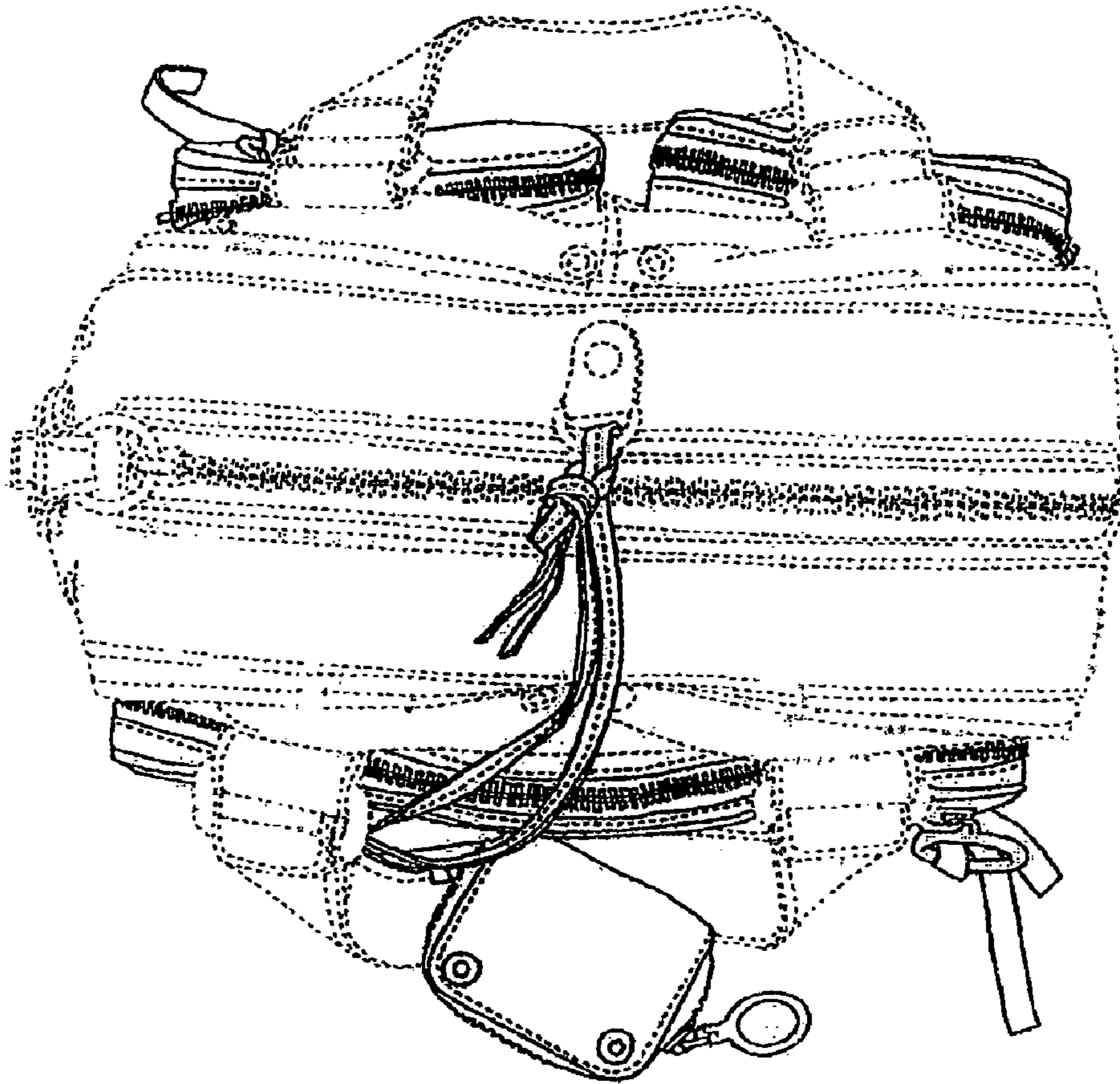

Fig. 41

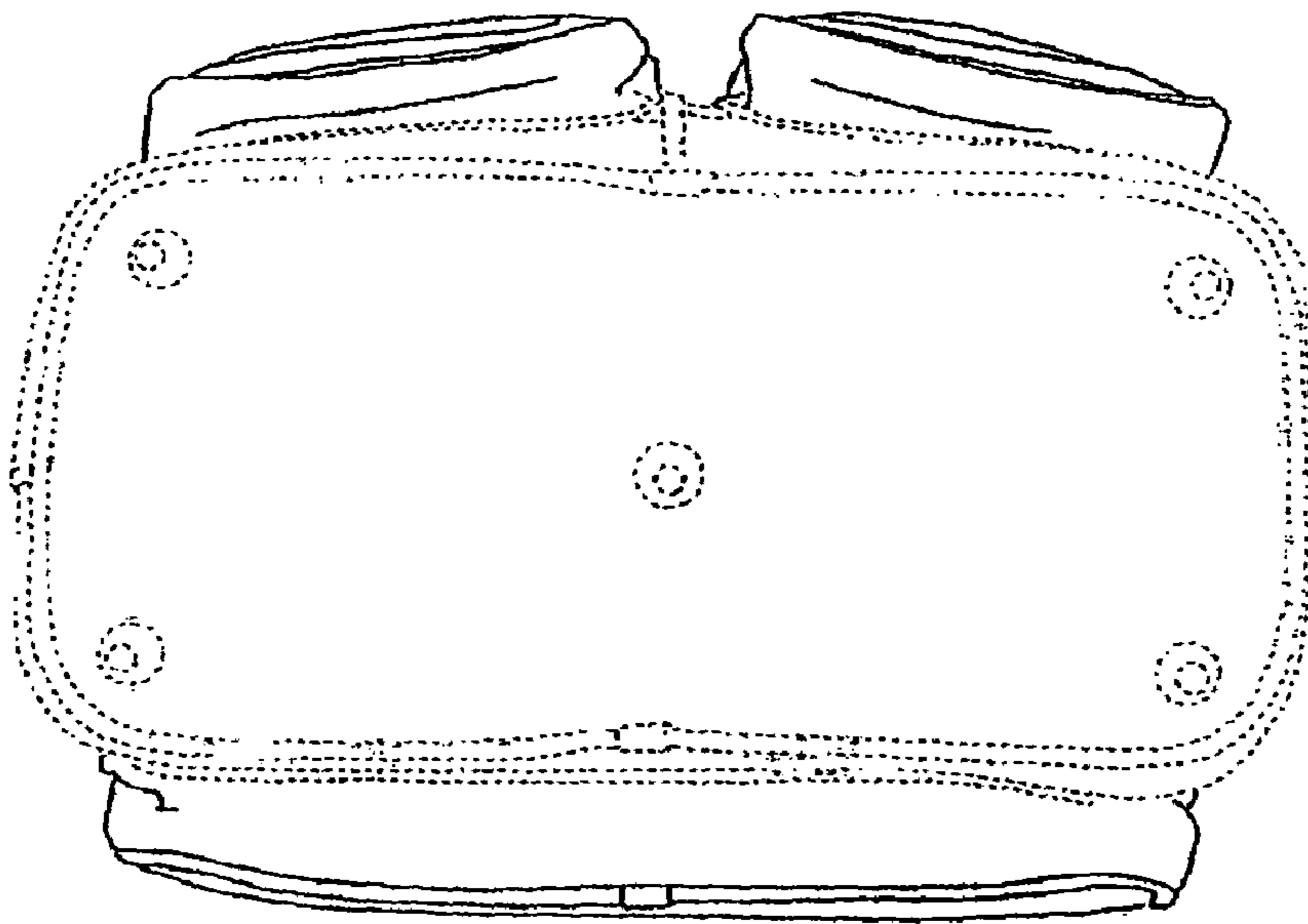

Fig. 42

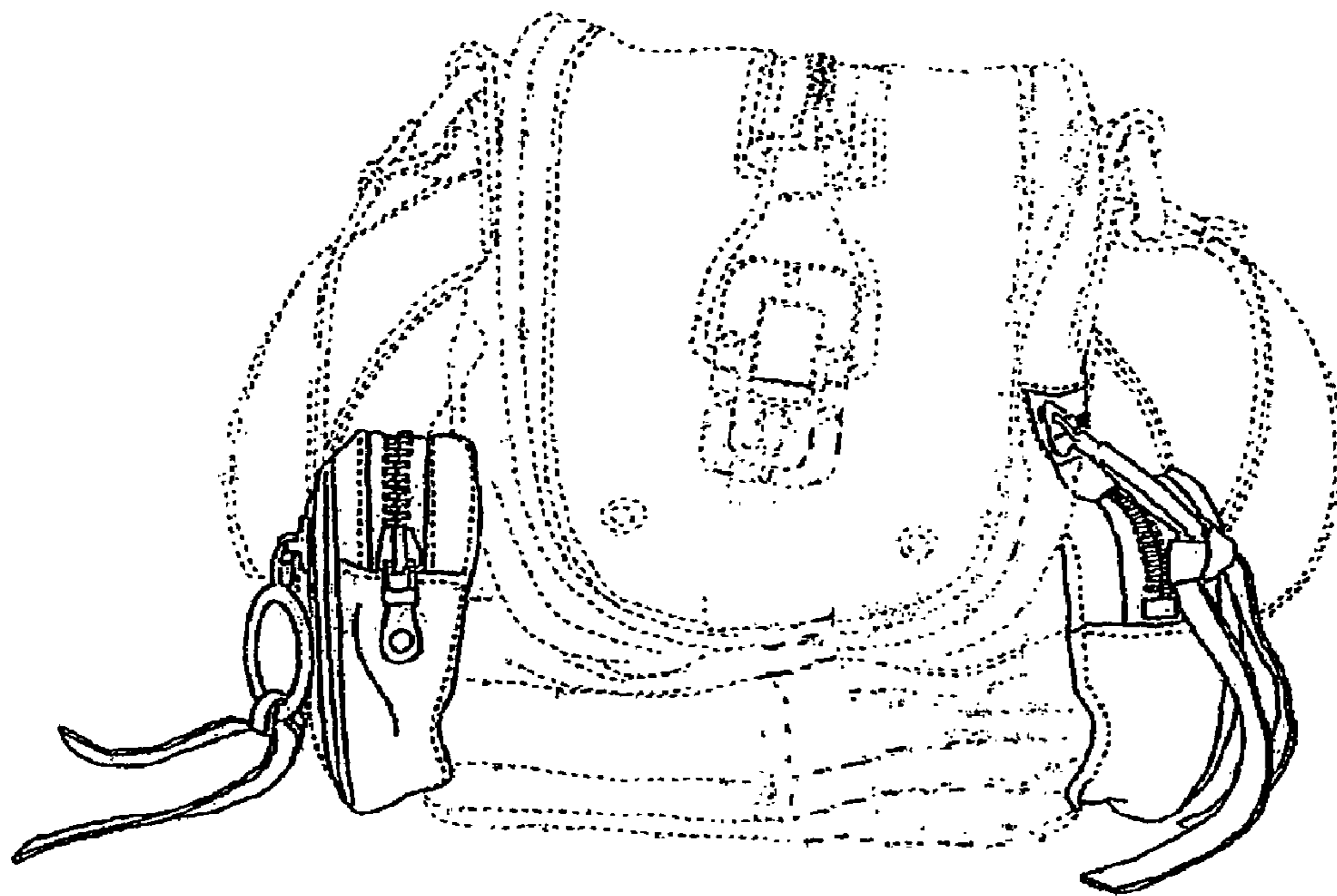

Fig. 43

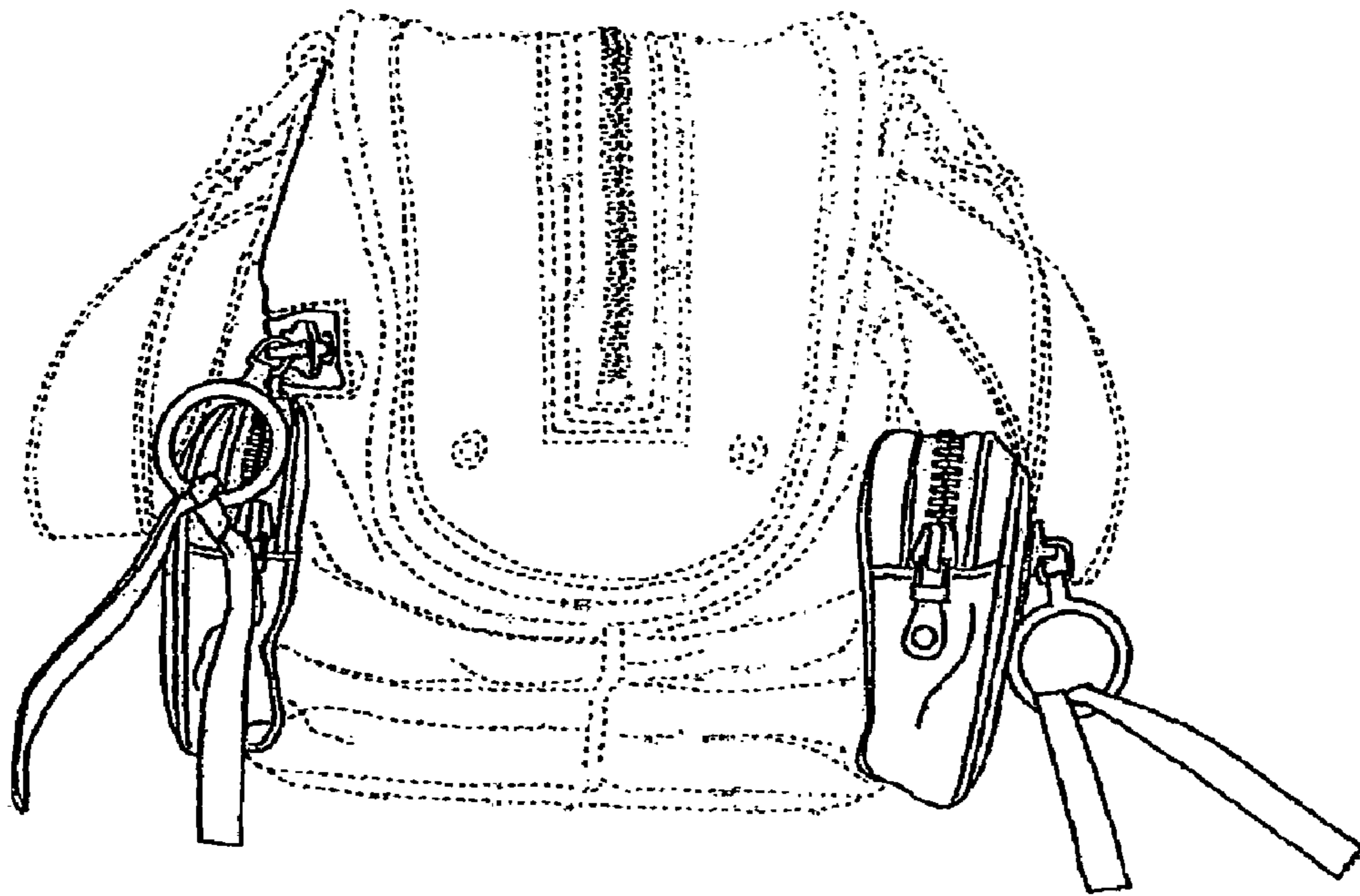

Fig. 44

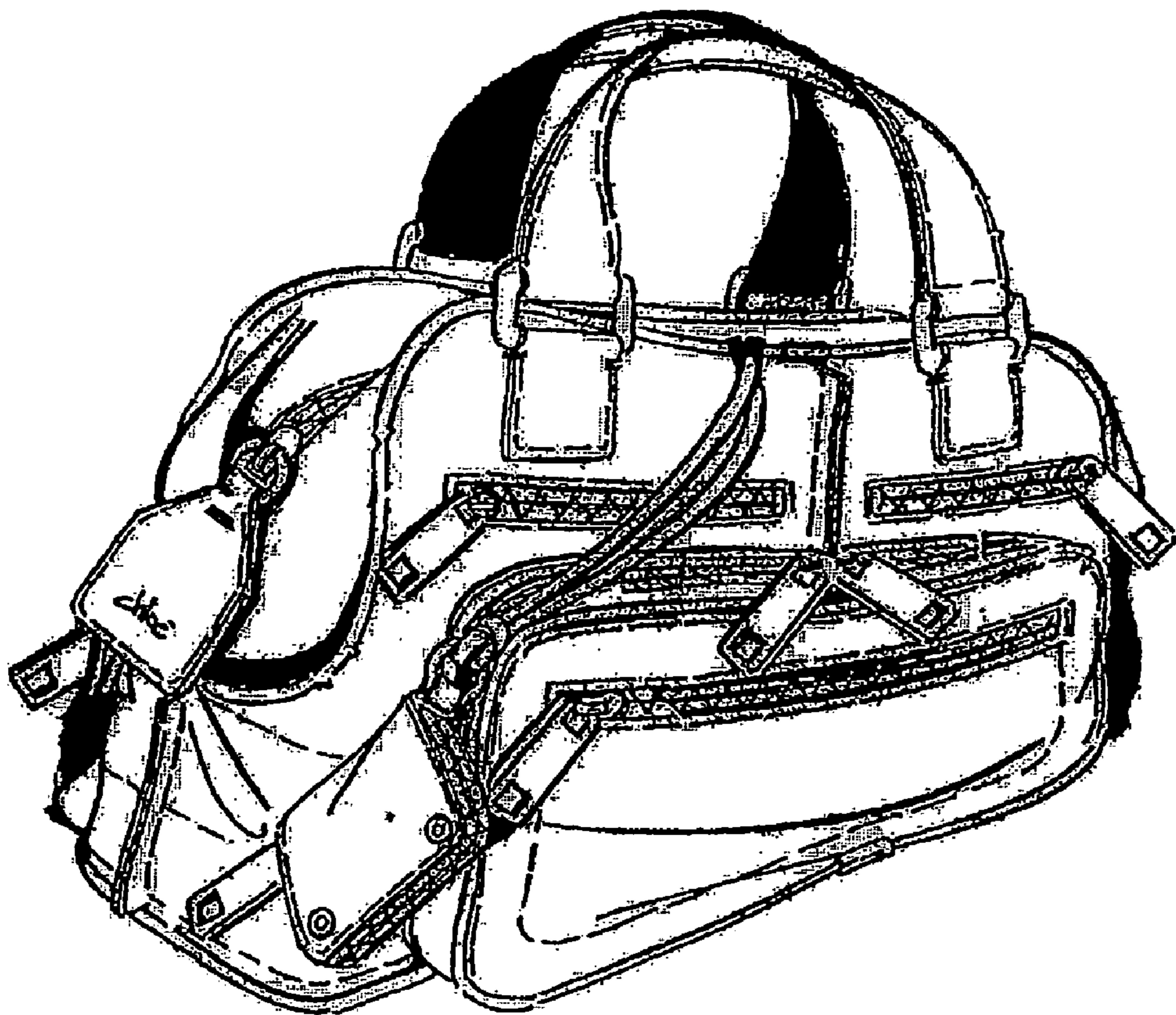

Fig. 45

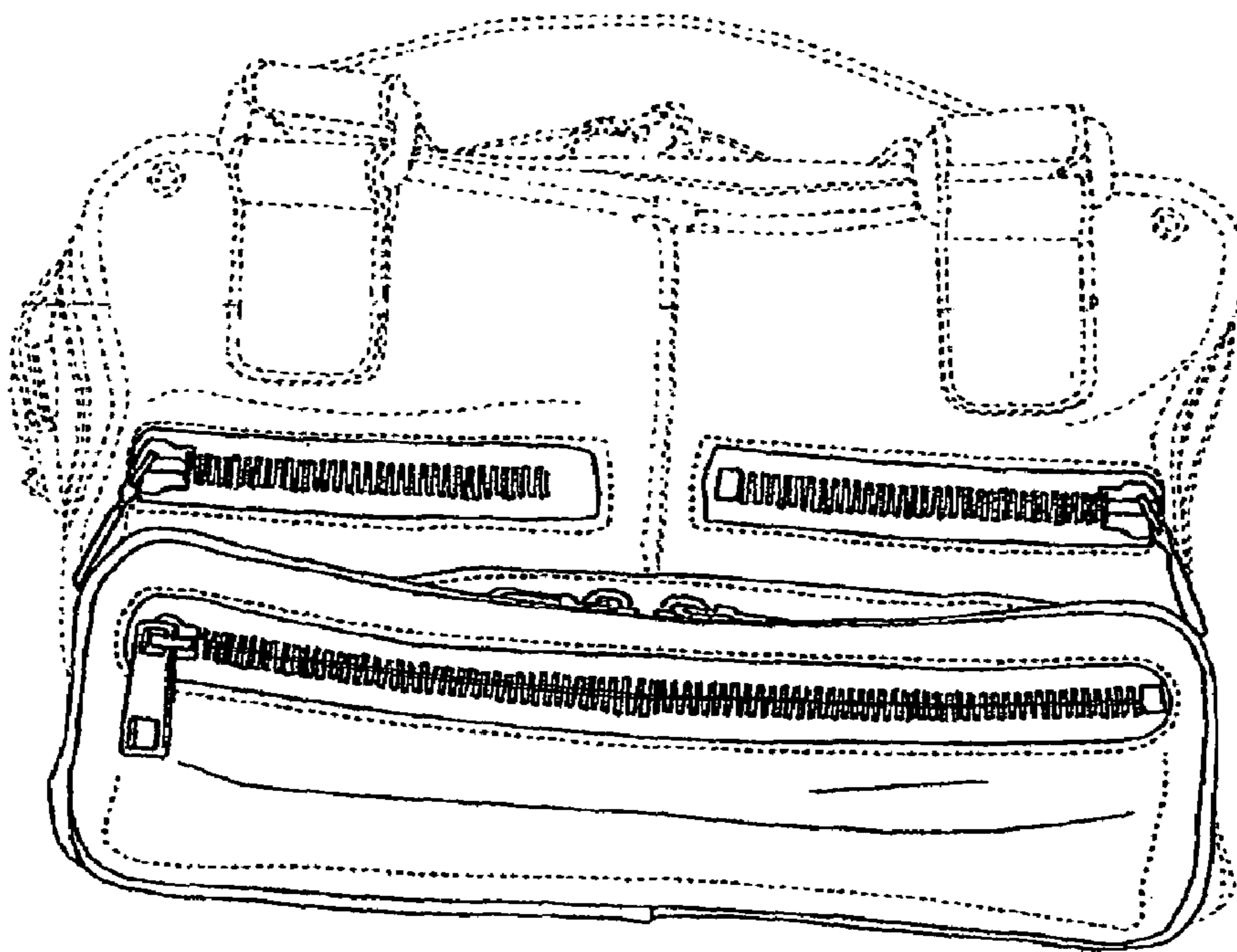

Fig. 46



Fig. 47

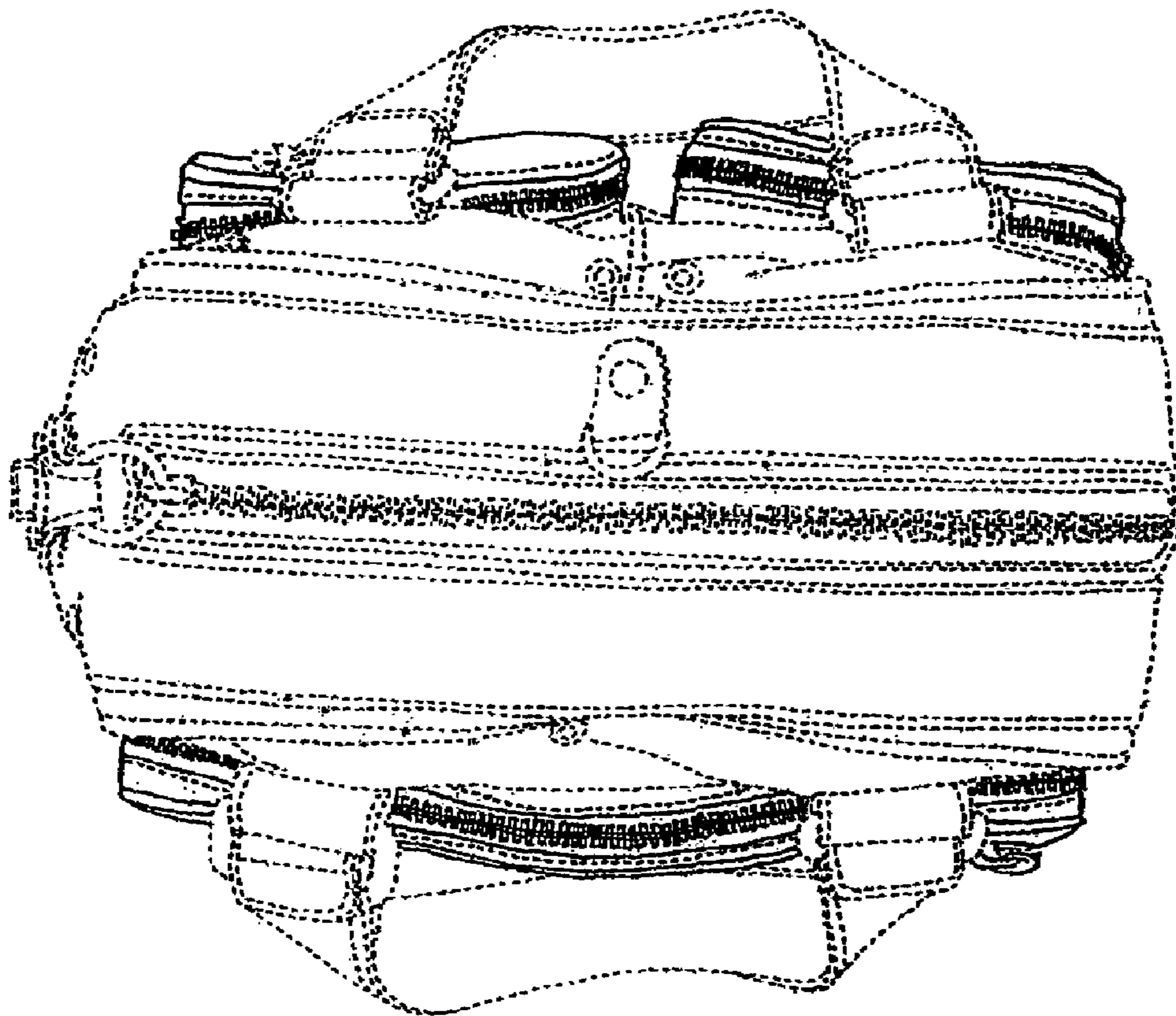

Fig. 48

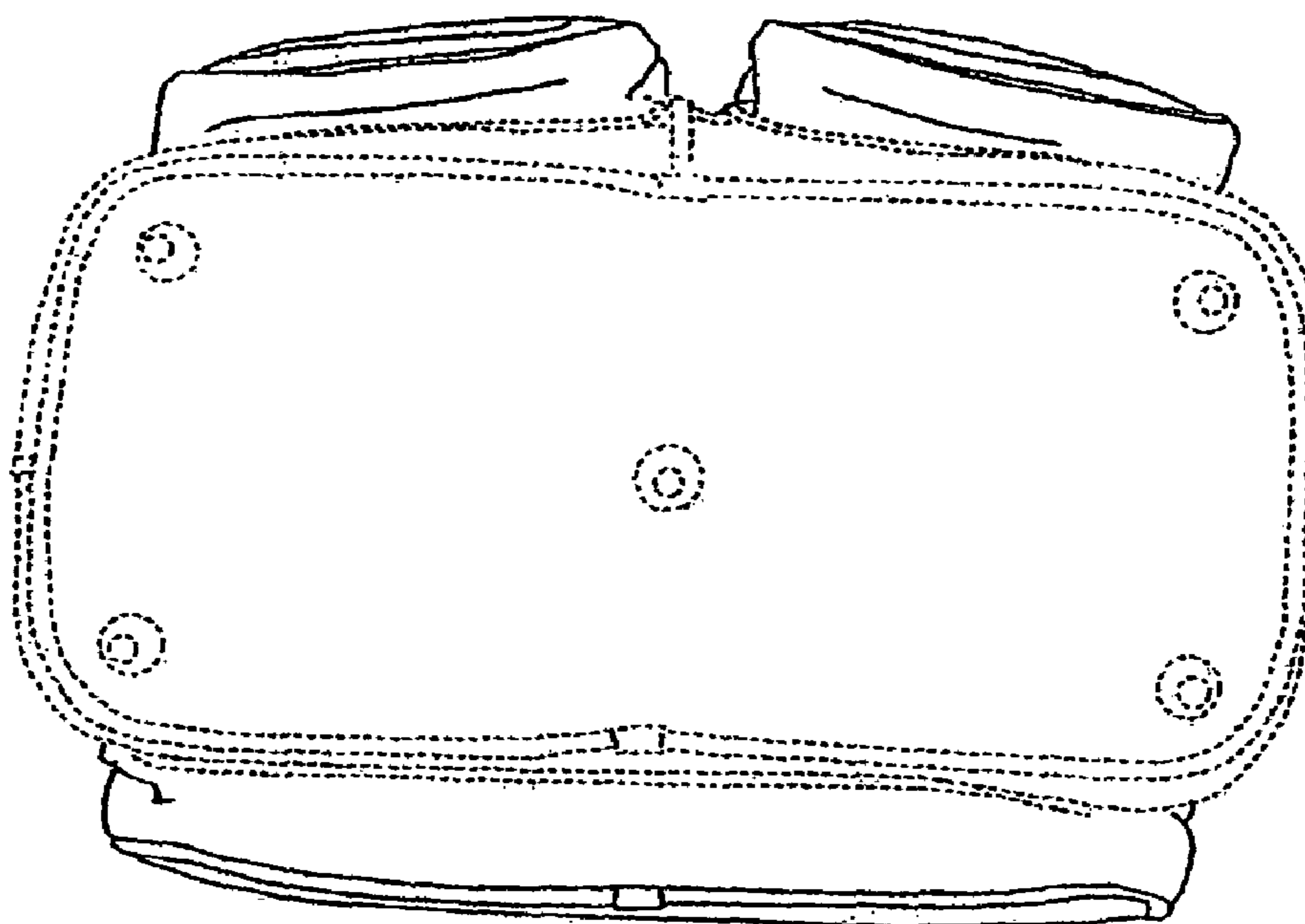

Fig. 49

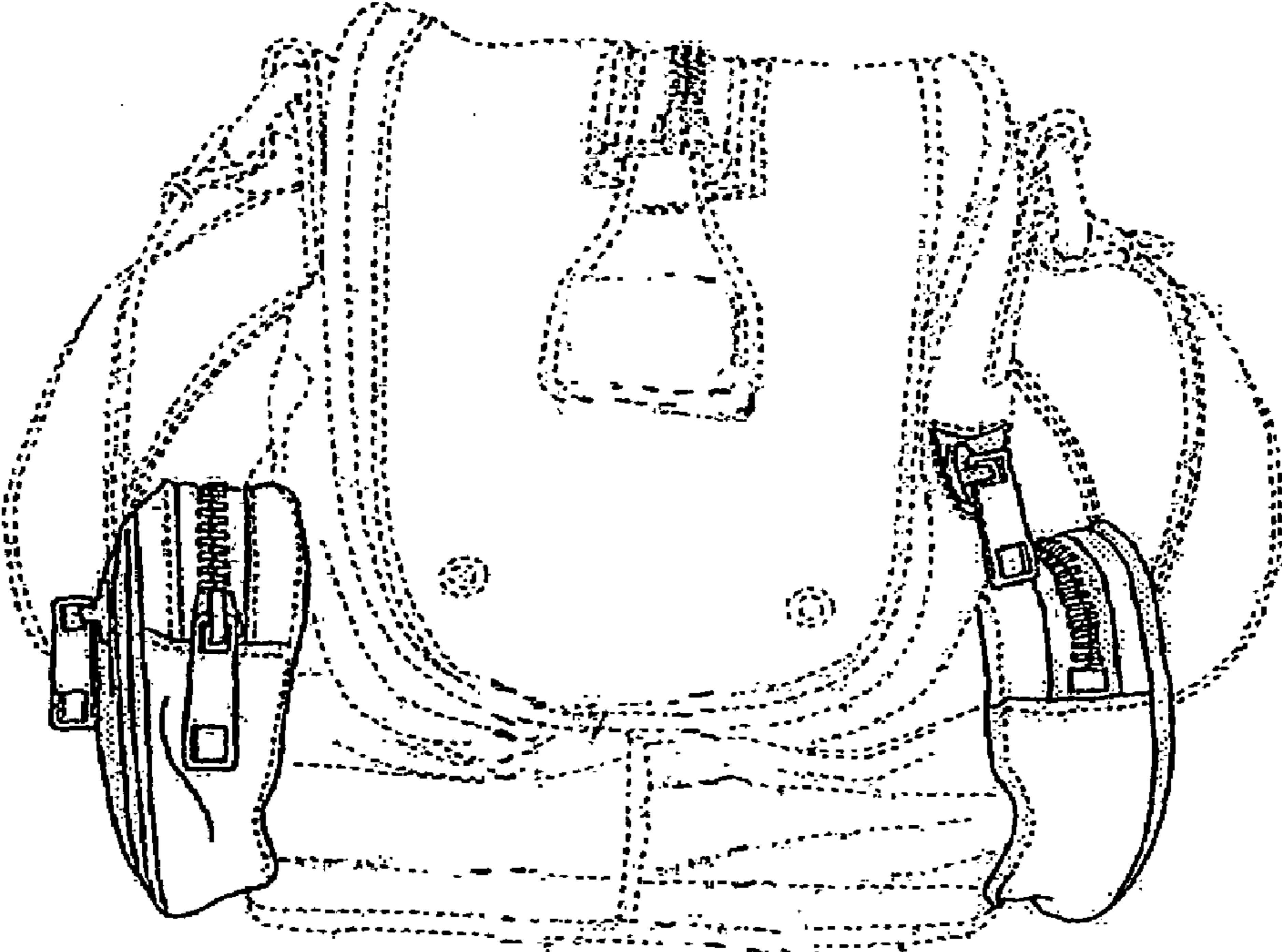

Fig. 50

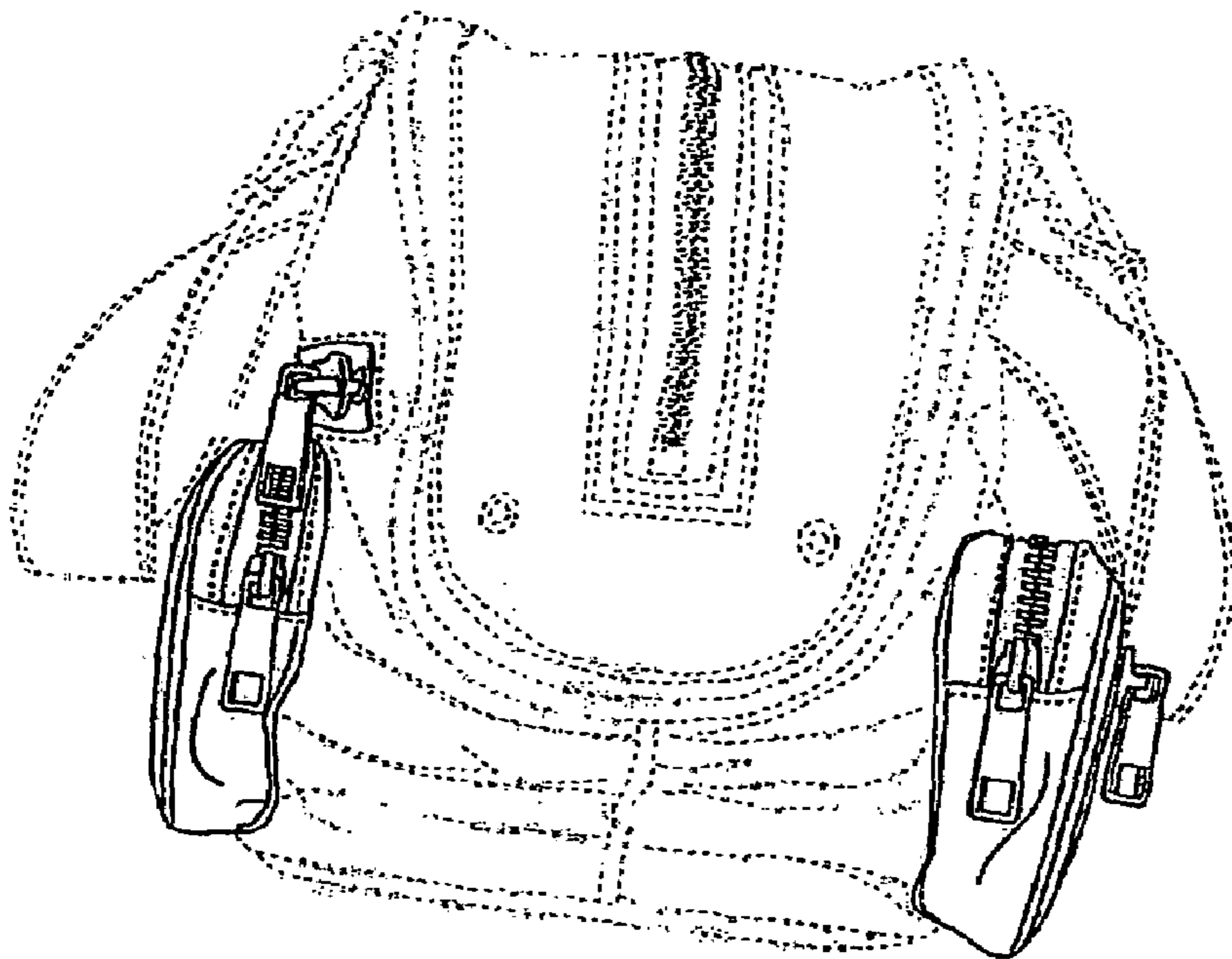

Fig. 51



Fig. 52

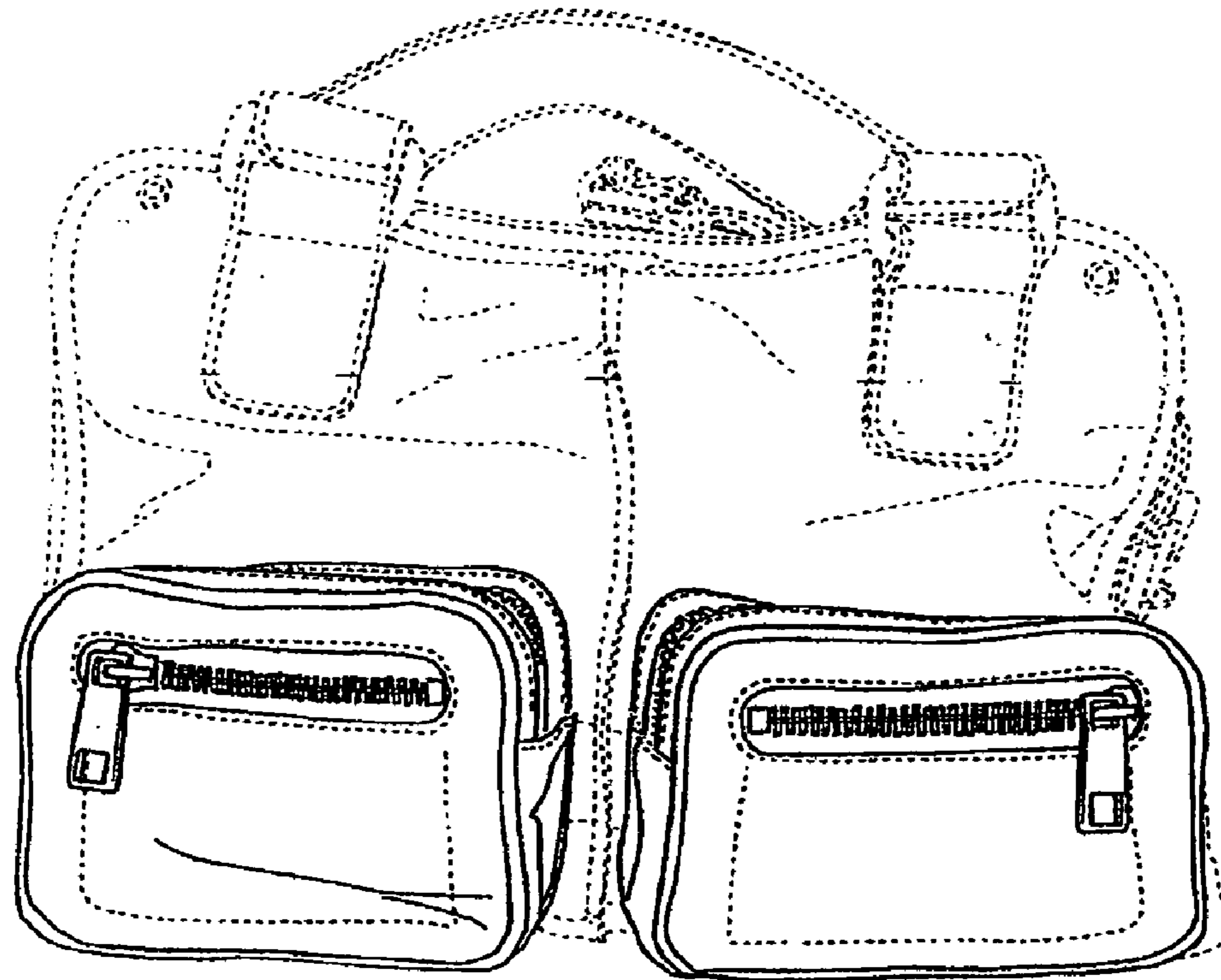

Fig. 53

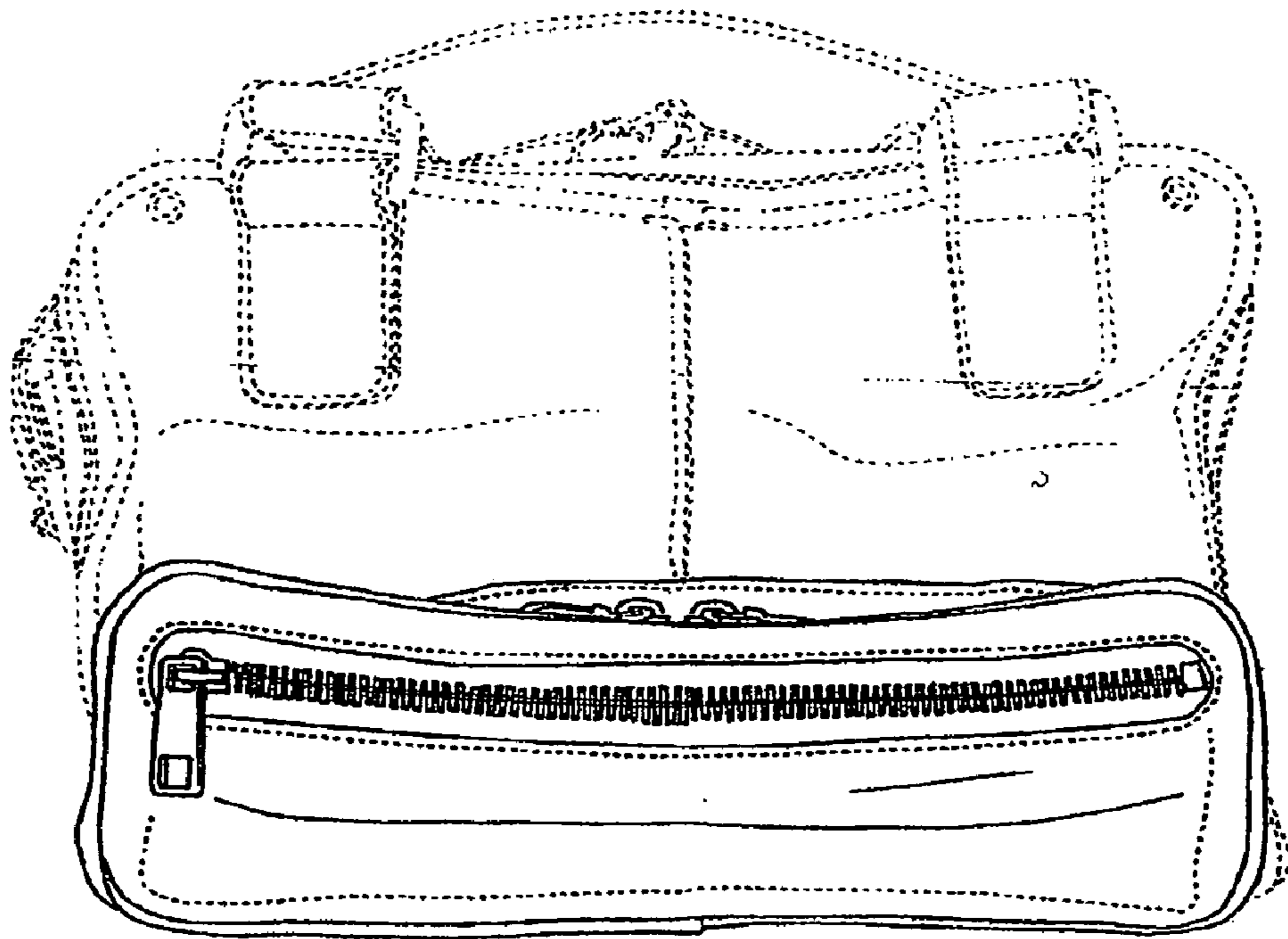

Fig. 54

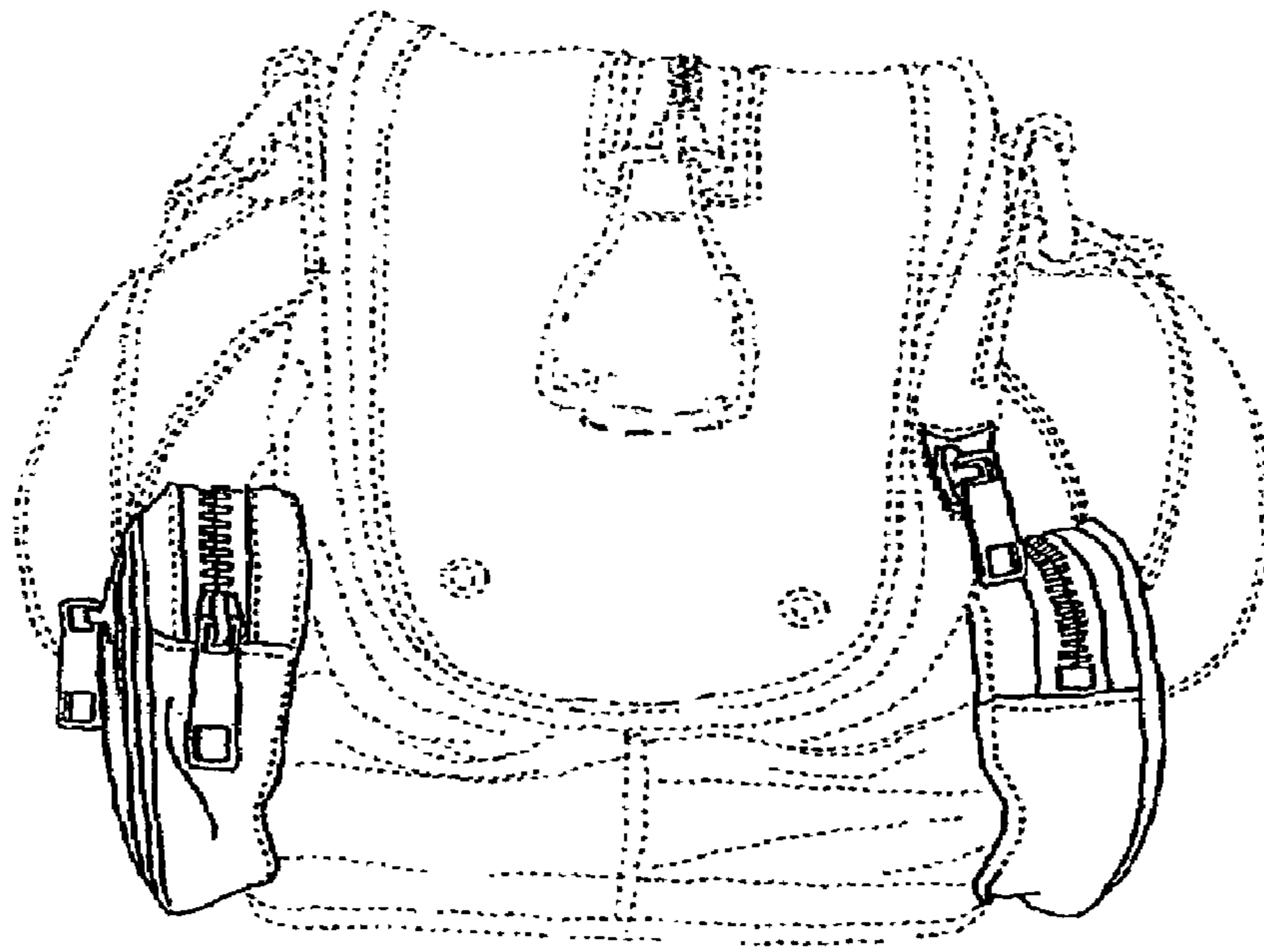

Fig. 55

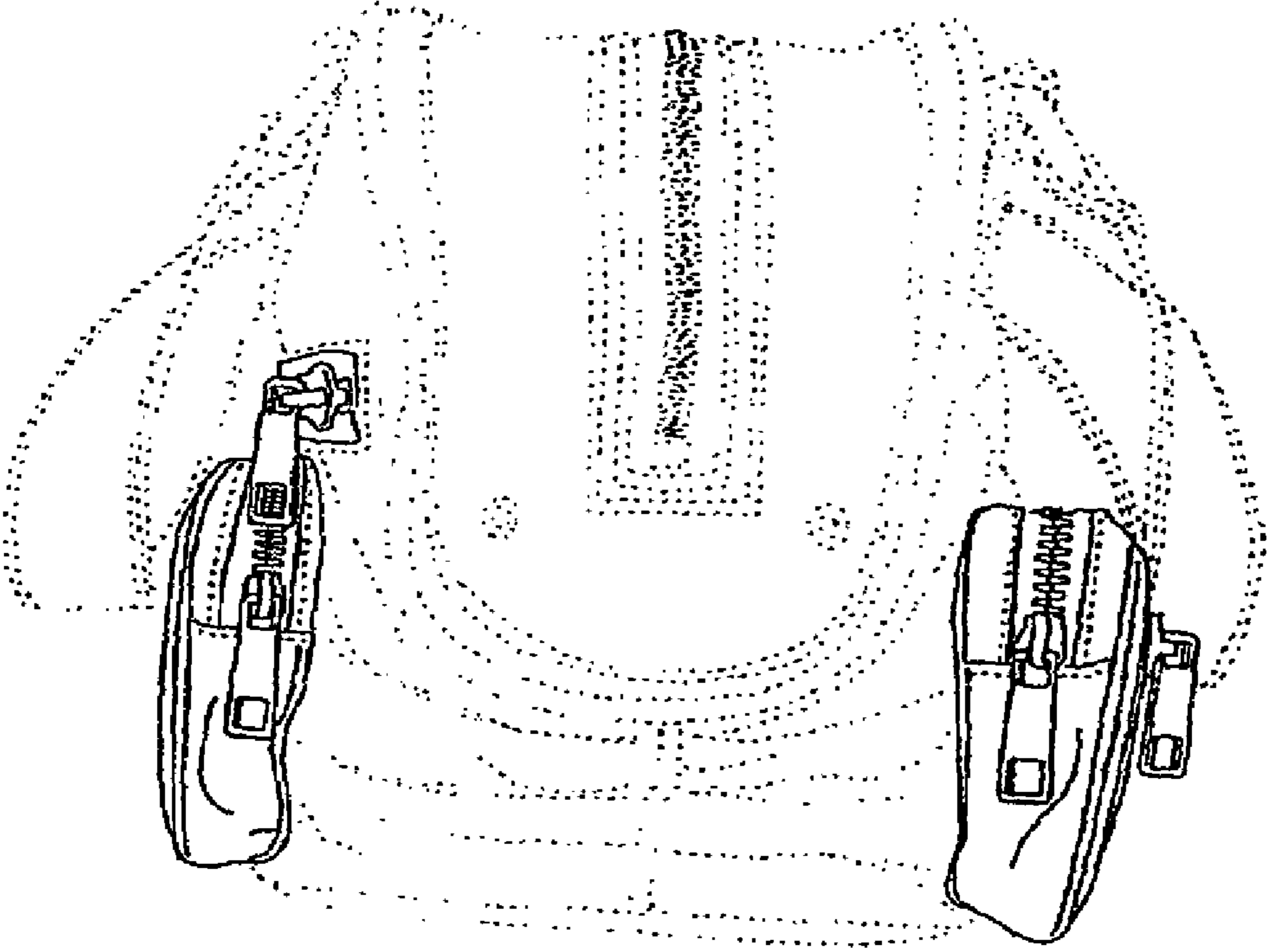

Fig. 56

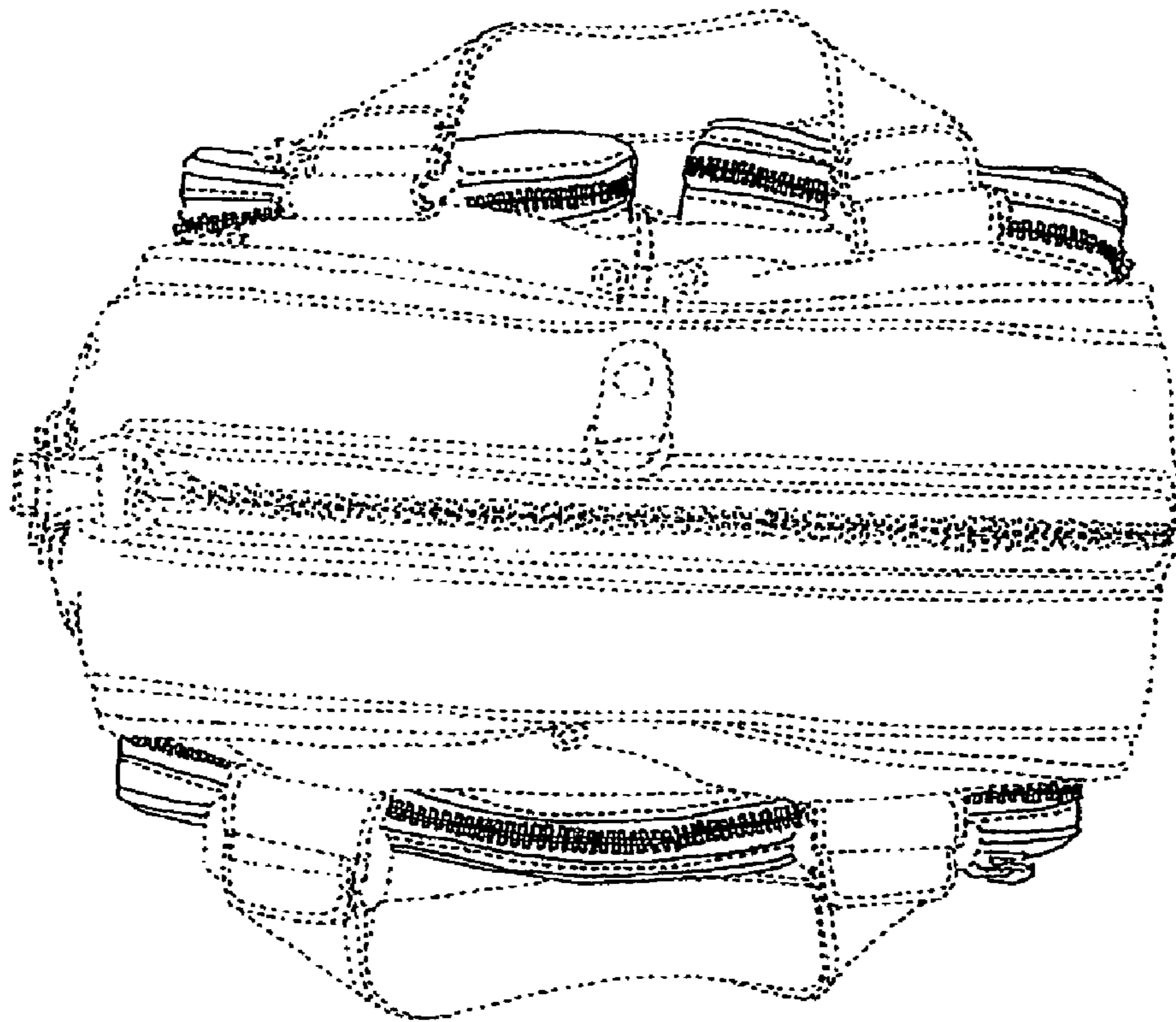

Fig. 57

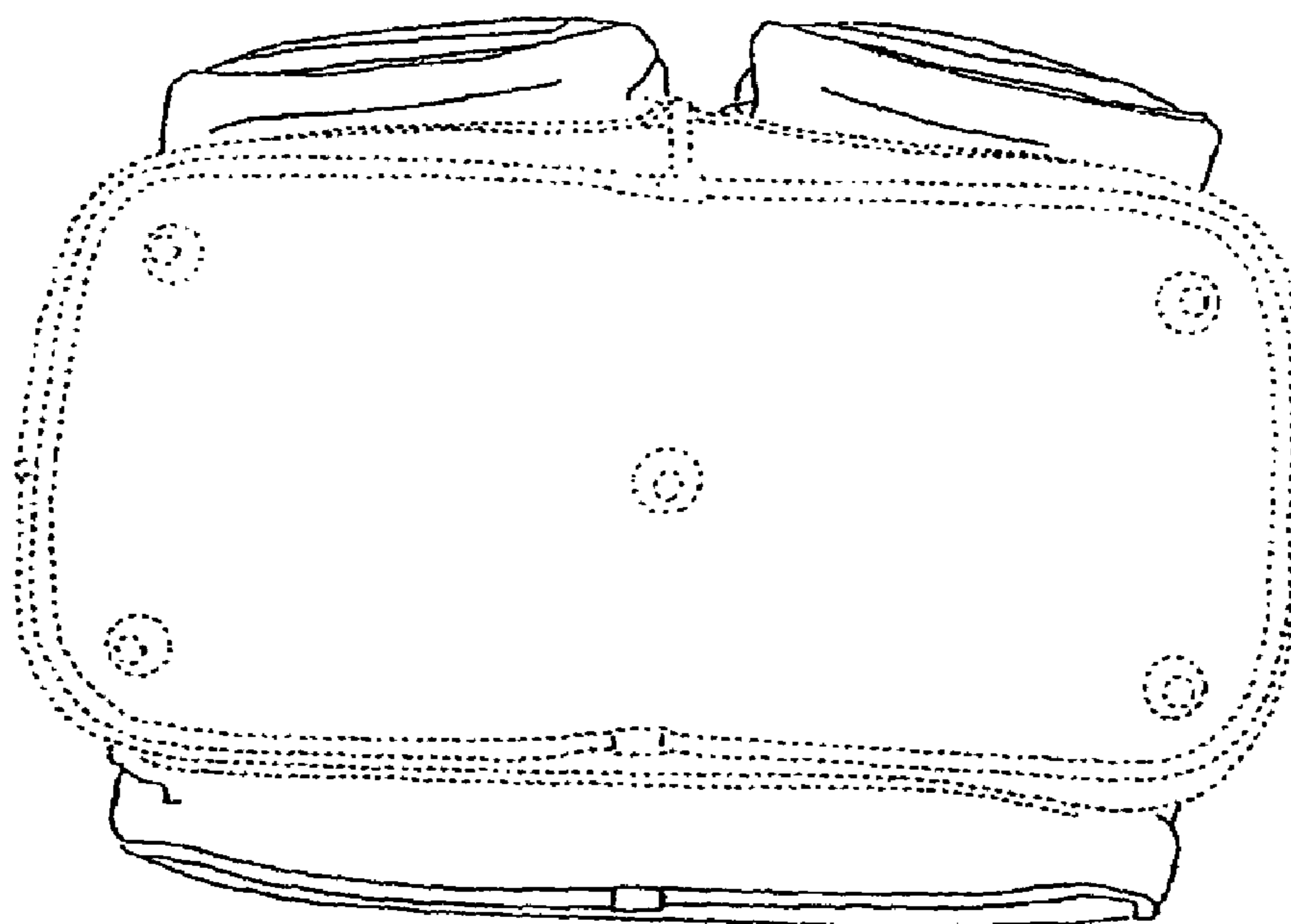

Fig. 58

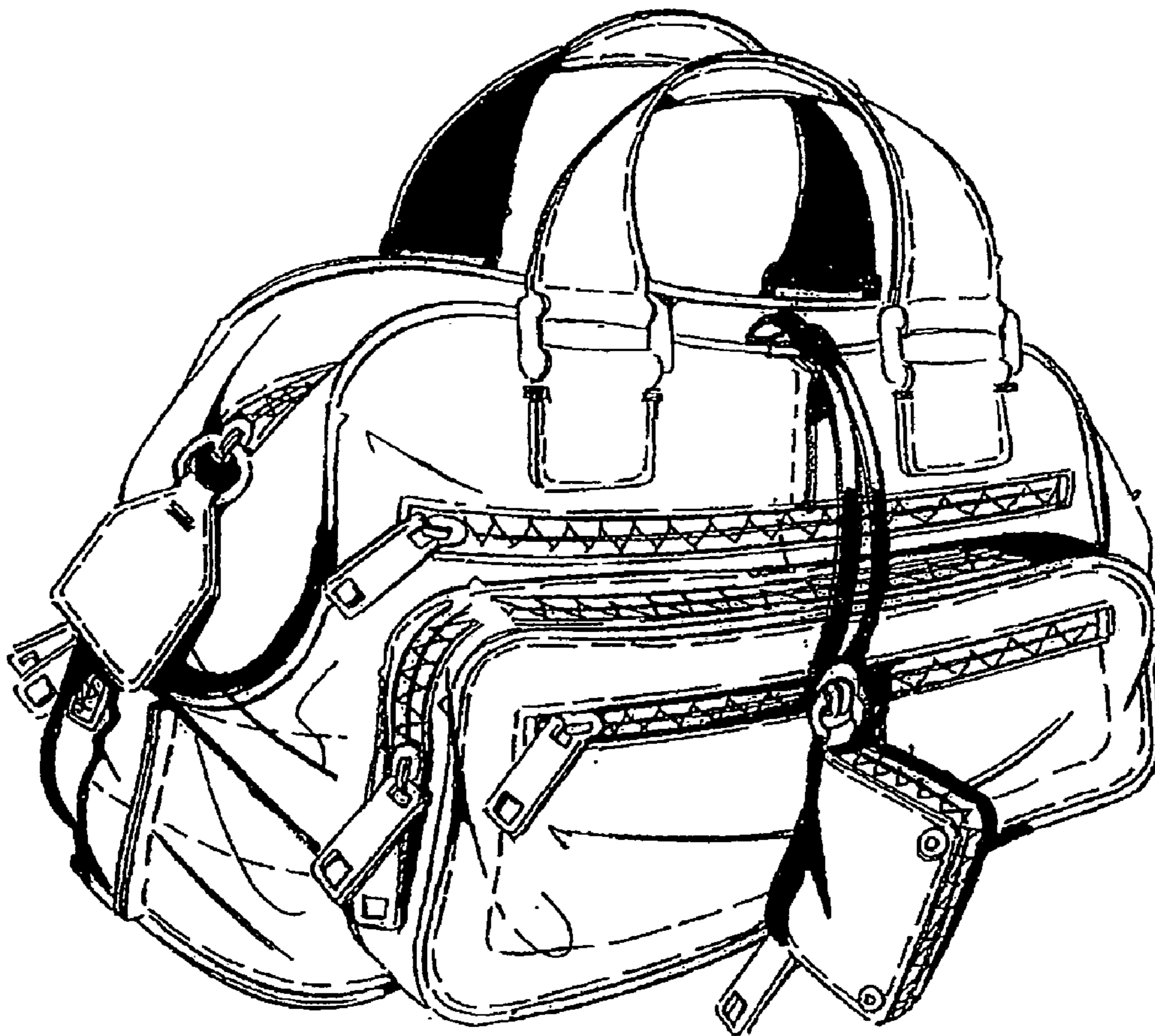

Fig. 59

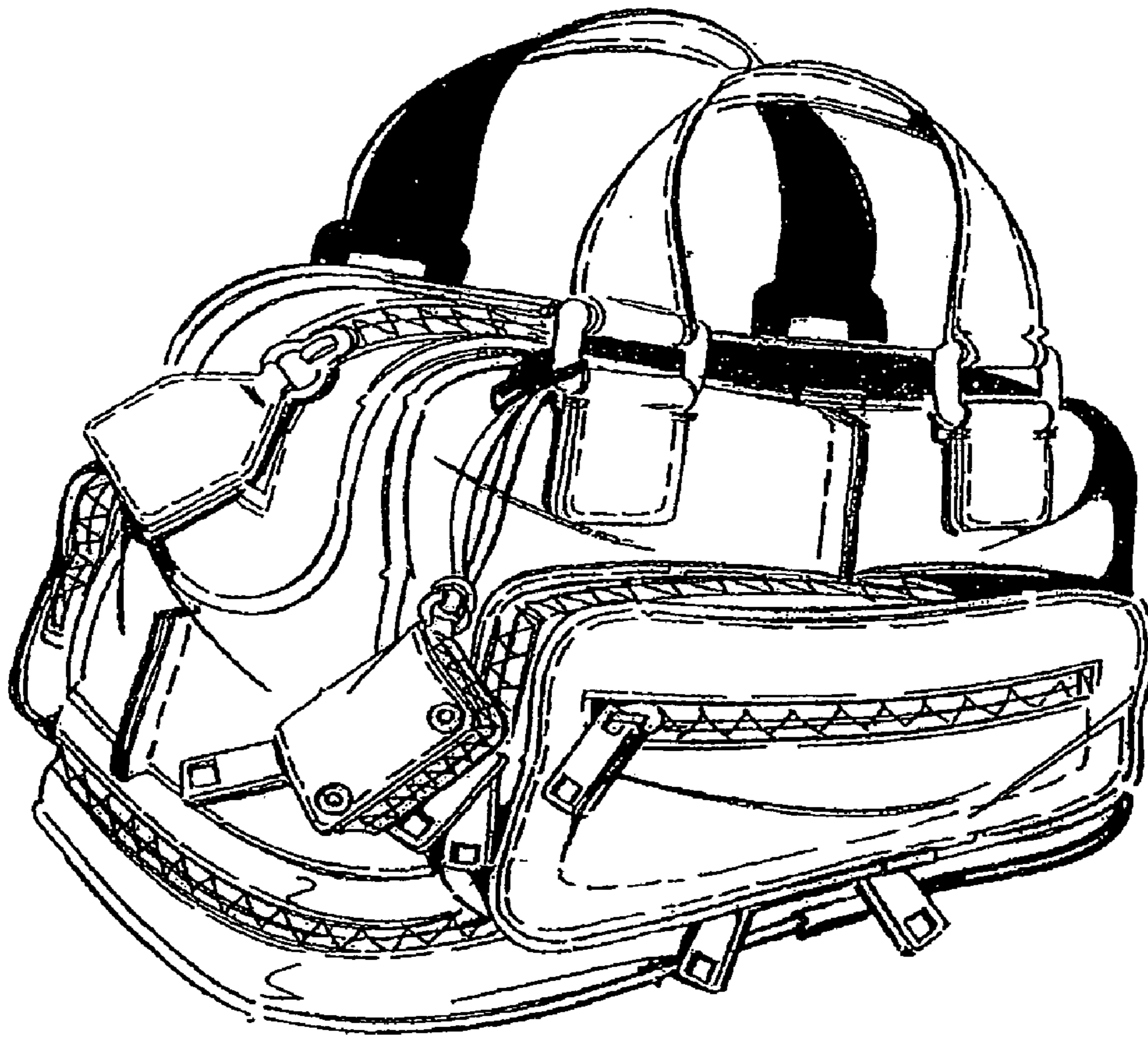

Fig. 60



Fig. 61

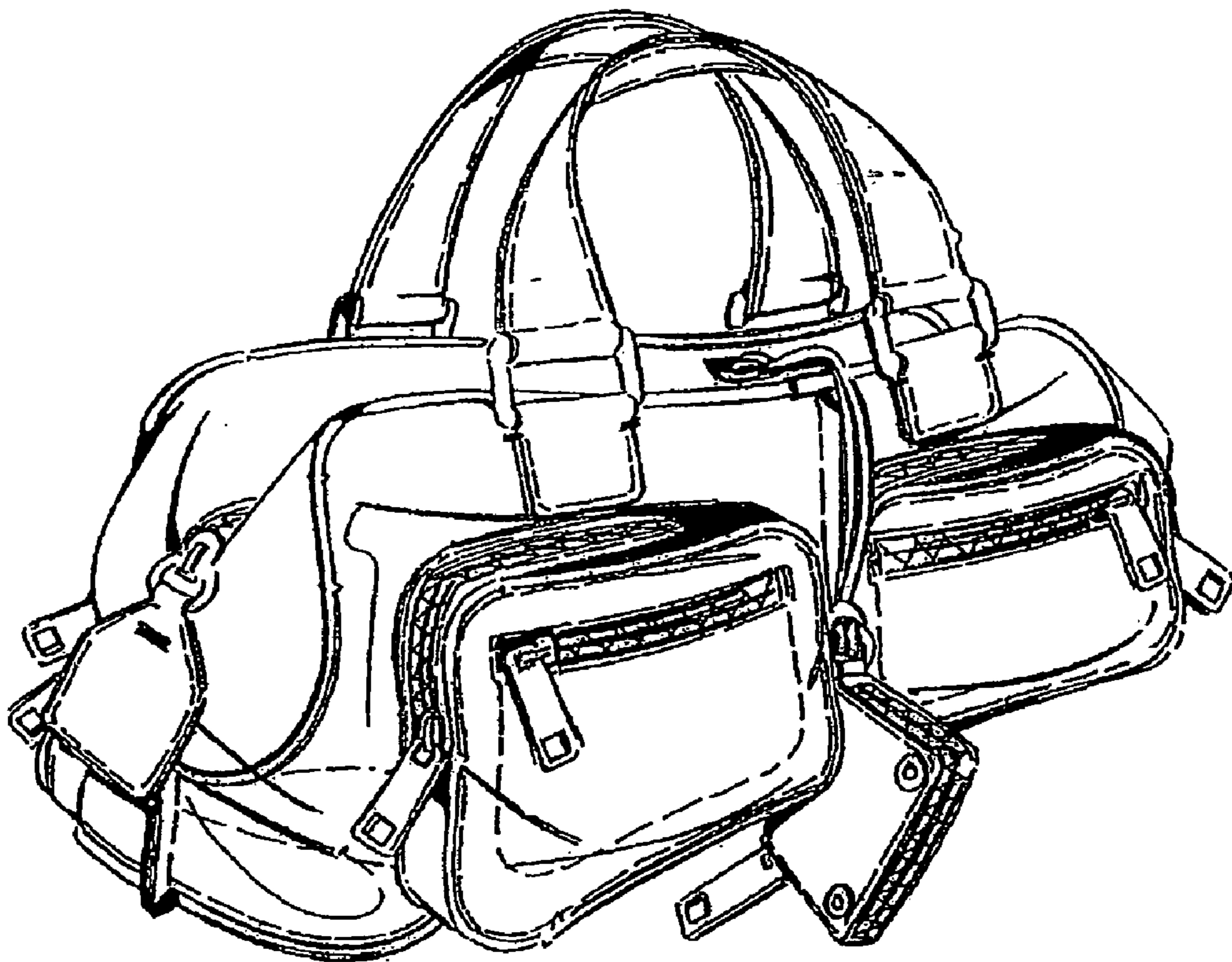

Fig. 62

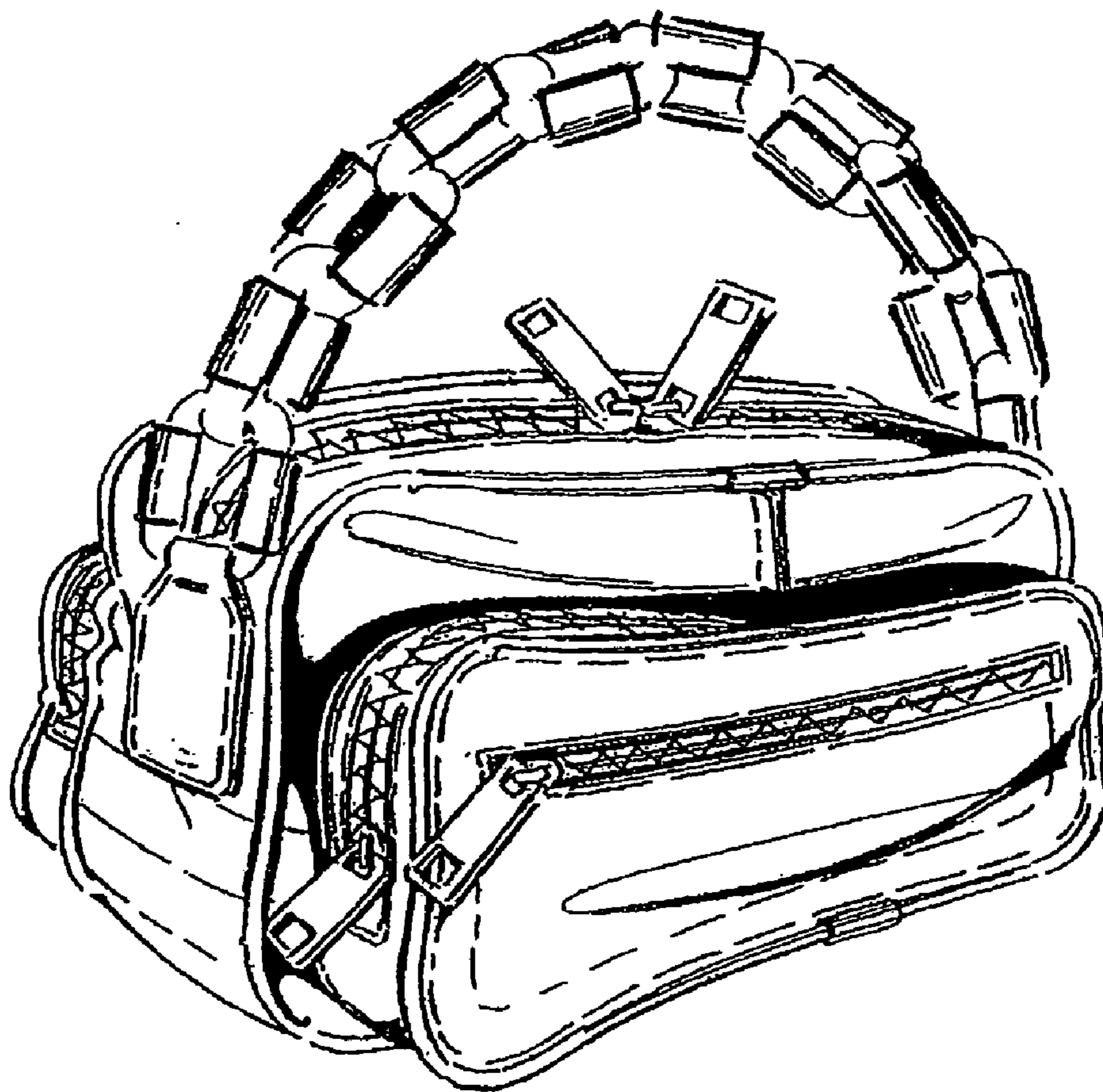

Fig. 63



UNITED STATES PATENT AND TRADEMARK OFFICE
CERTIFICATE OF CORRECTION

PATENT NO. : D572,469 S
APPLICATION NO. : 29/254394
DATED : July 8, 2008
INVENTOR(S) : Morelli

Page 1 of 5

It is certified that error appears in the above-identified patent and that said Letters Patent is hereby corrected as shown below:

Please delete the title page showing an illustrative figure should be deleted and substitute therefor the attached title page

Delete drawing sheet 1 thru 61 and insert drawing sheet 1 thru 3 consisting figures 1-6 as attached

Signed and Sealed this
Eleventh Day of October, 2011

A handwritten signature in black ink that reads "David J. Kappos". The signature is written in a cursive style with a large initial 'D' and 'K'.

David J. Kappos
Director of the United States Patent and Trademark Office

(12) **United States Design Patent**
Morelli

(10) **Patent No.:** **US D572,469 S**
(45) **Date of Patent:** **** Jul. 8, 2008**

(54) **HANDBAG**

(75) **Inventor:** **Giovanni Morelli, Milan (IT)**

(73) **Assignee:** **Chloe Societe Anonyme, Paris (FR)**

(**) **Term:** **14 Years**

(21) **Appl. No.:** **29/254,394**

(22) **Filed:** **Feb. 22, 2006**

(51) **LOC (8) Cl.** **03-01**

(52) **U.S. Cl.** **D3/232**

(58) **Field of Classification Search** **D3/232,**
D3/234, 238, 240-246, 303, 318-326, 900,
D3/902; 150/100, 107-111, 118-120; 190/100,
190/108-112, 115, 900, 902-903

See application file for complete search history.

(56) **References Cited**

U.S. PATENT DOCUMENTS

D390.004 S *	2/1998	Tawil	D3/246
D426.060 S *	6/2000	Chapelier	D3/303
D453.621 S *	2/2002	Chapelier	D3/252
D459.076 S *	6/2002	Chapelier	D3/289

D465.925 S *	11/2002	Chapelier	D3/303
D472.046 S *	3/2003	Galliano	D3/243
D492.482 S *	7/2004	Hanley	D3/243
D533.716 S *	12/2006	Brocart	D3/246
D538.532 S *	3/2007	Cassegrain	D3/232
D543.027 S *	5/2007	Wang	D3/246

* cited by examiner

Primary Examiner — Louis S Zarfes

Assistant Examiner — Michelle E Wilson

(74) *Attorney, Agent, or Firm* — Kalow & Springut, LLP

(57) **CLAIM**

The ornamental design of a handbag, as shown and described.

DESCRIPTION

FIG. 1 is a front view of a handbag.

FIG. 2 is a rear view of a handbag.

FIG. 3 is a top view of a handbag.

FIG. 4 is bottom view of a handbag.

FIG. 5 is a right side view of a handbag; and,

FIG. 6 is a left side view of a handbag.

The broken lines of the figures are for illustrative purposes only and form no part of the claimed design.

1 Claim, 3 Drawing Sheets

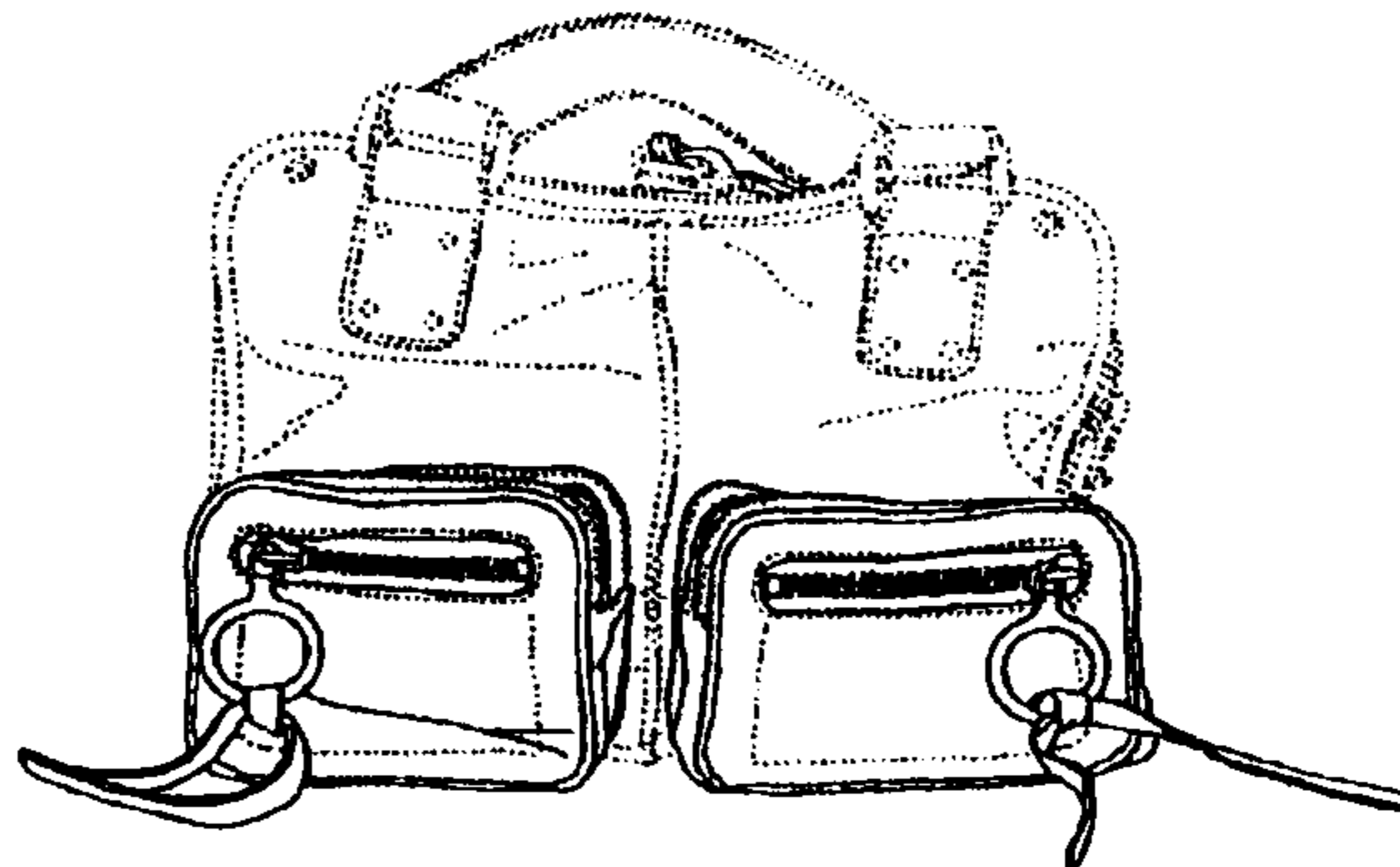
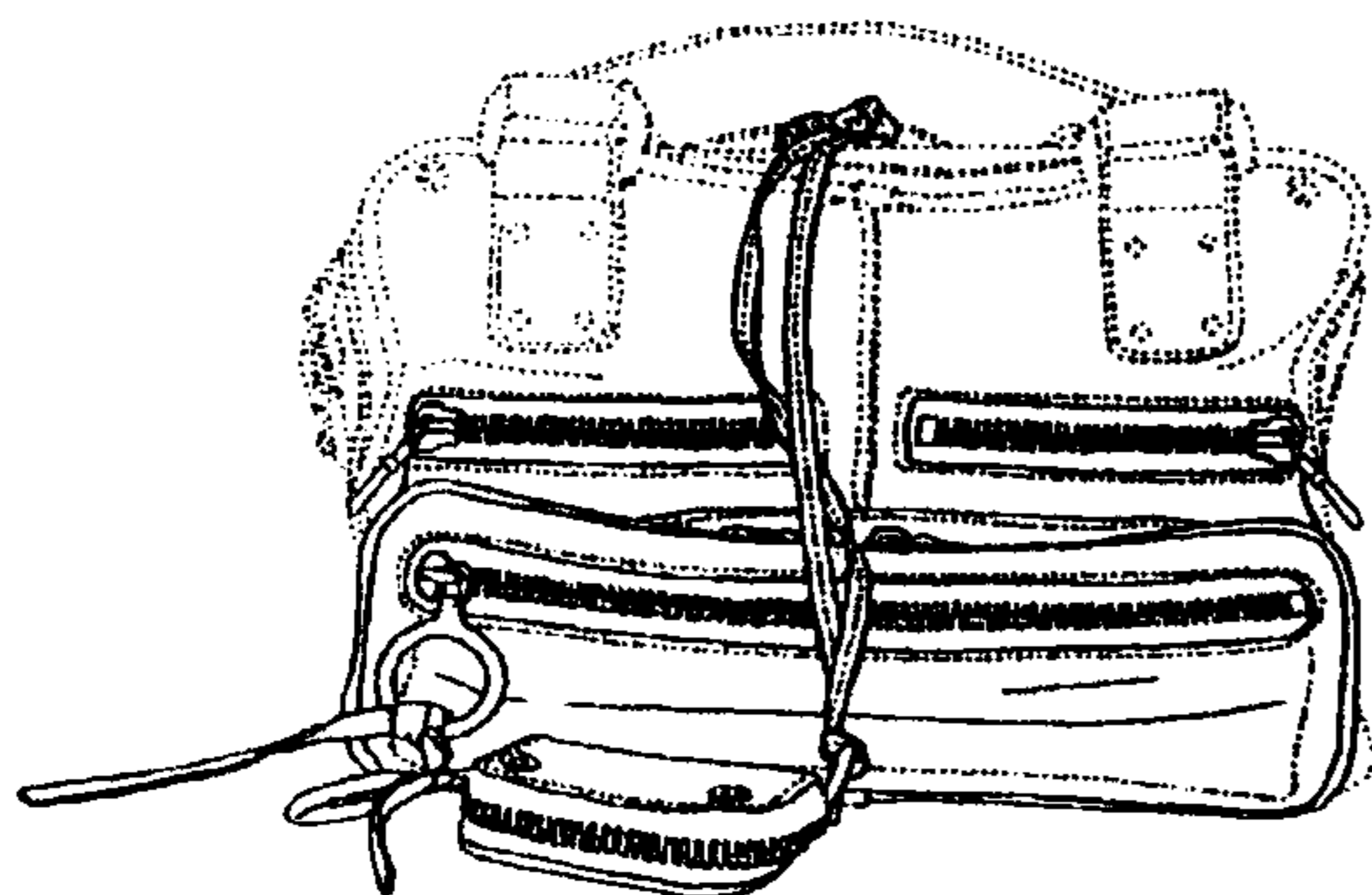



FIG. 1

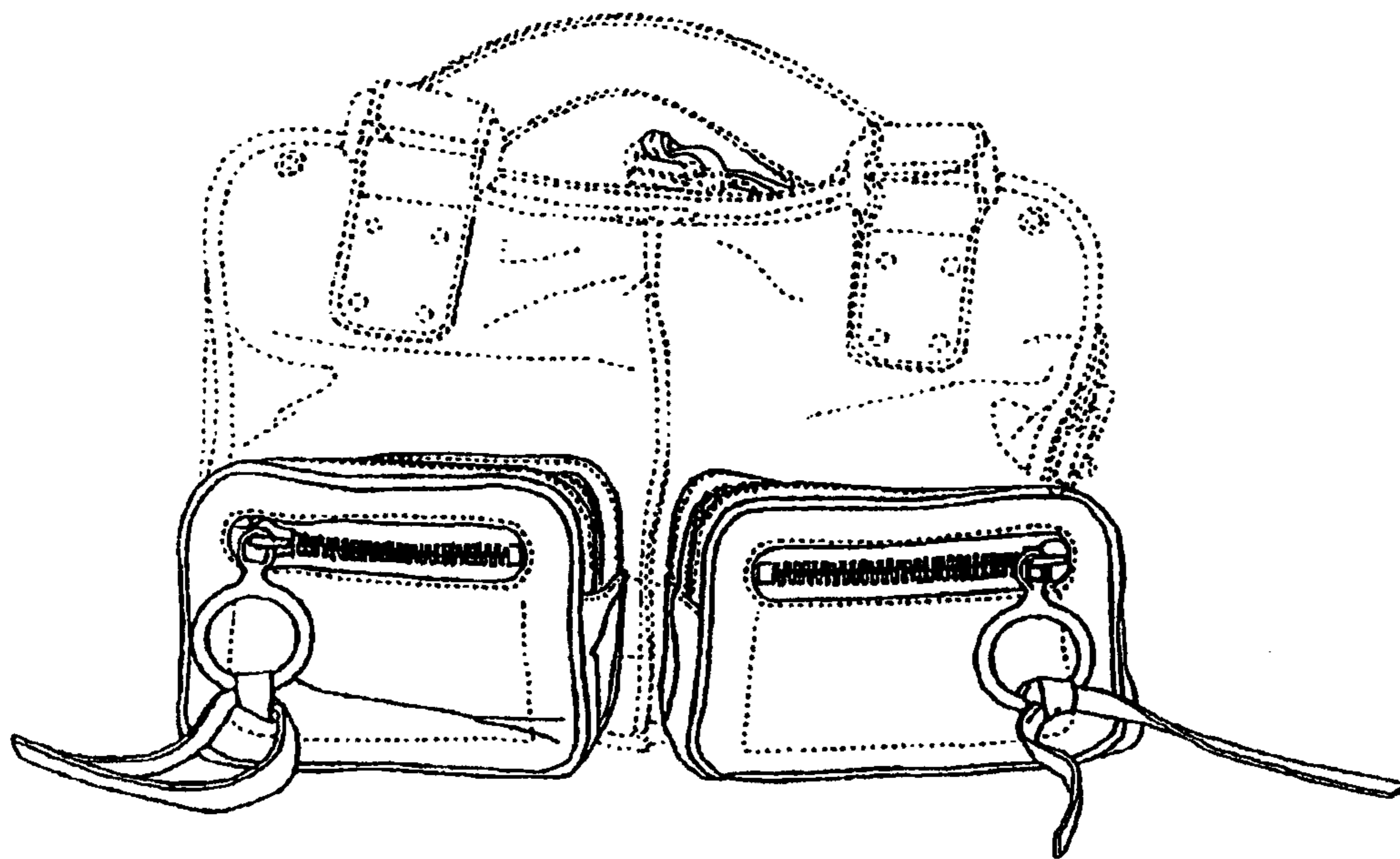

FIG. 2

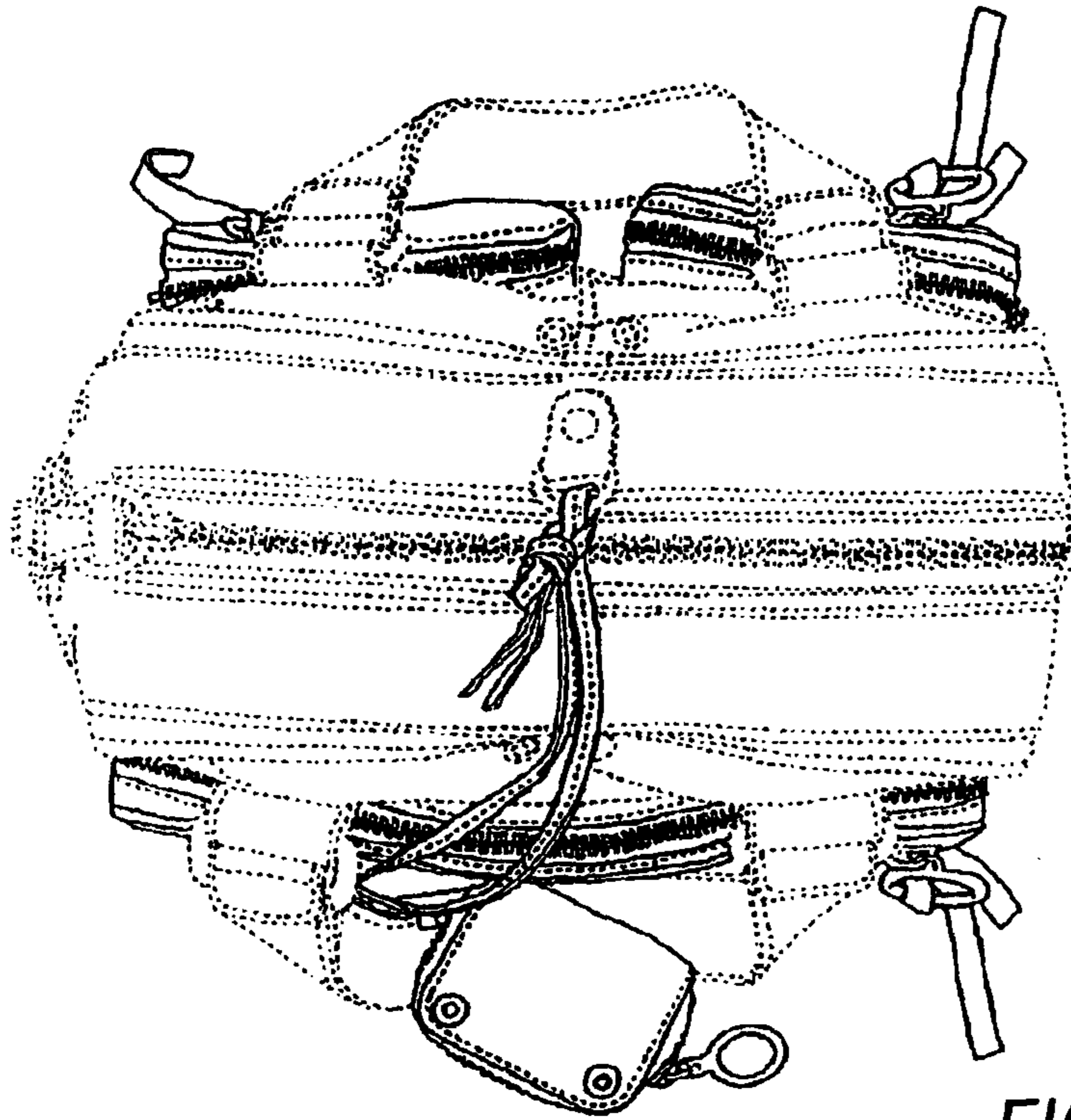

FIG. 3

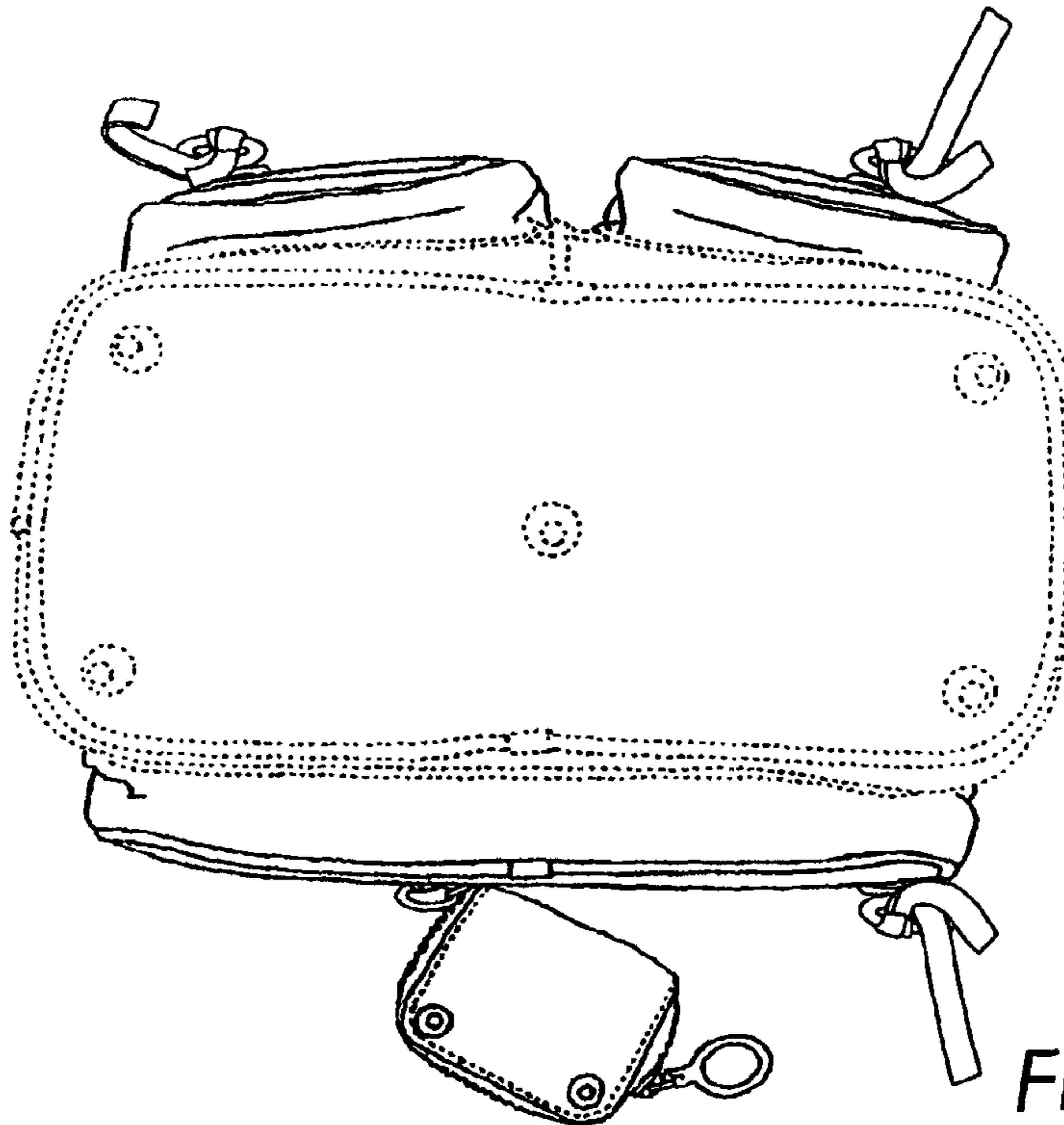

FIG. 4

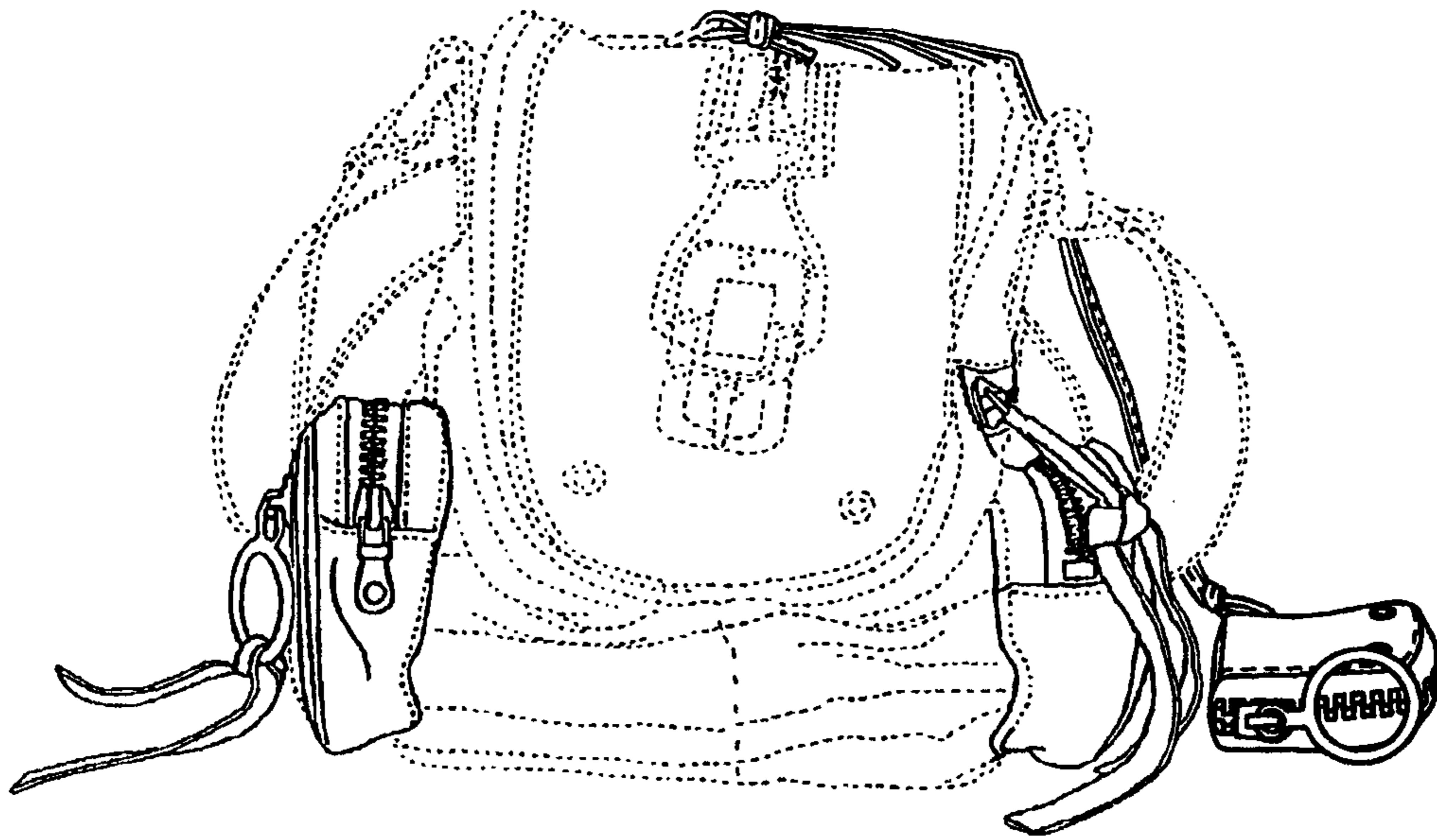

FIG. 5

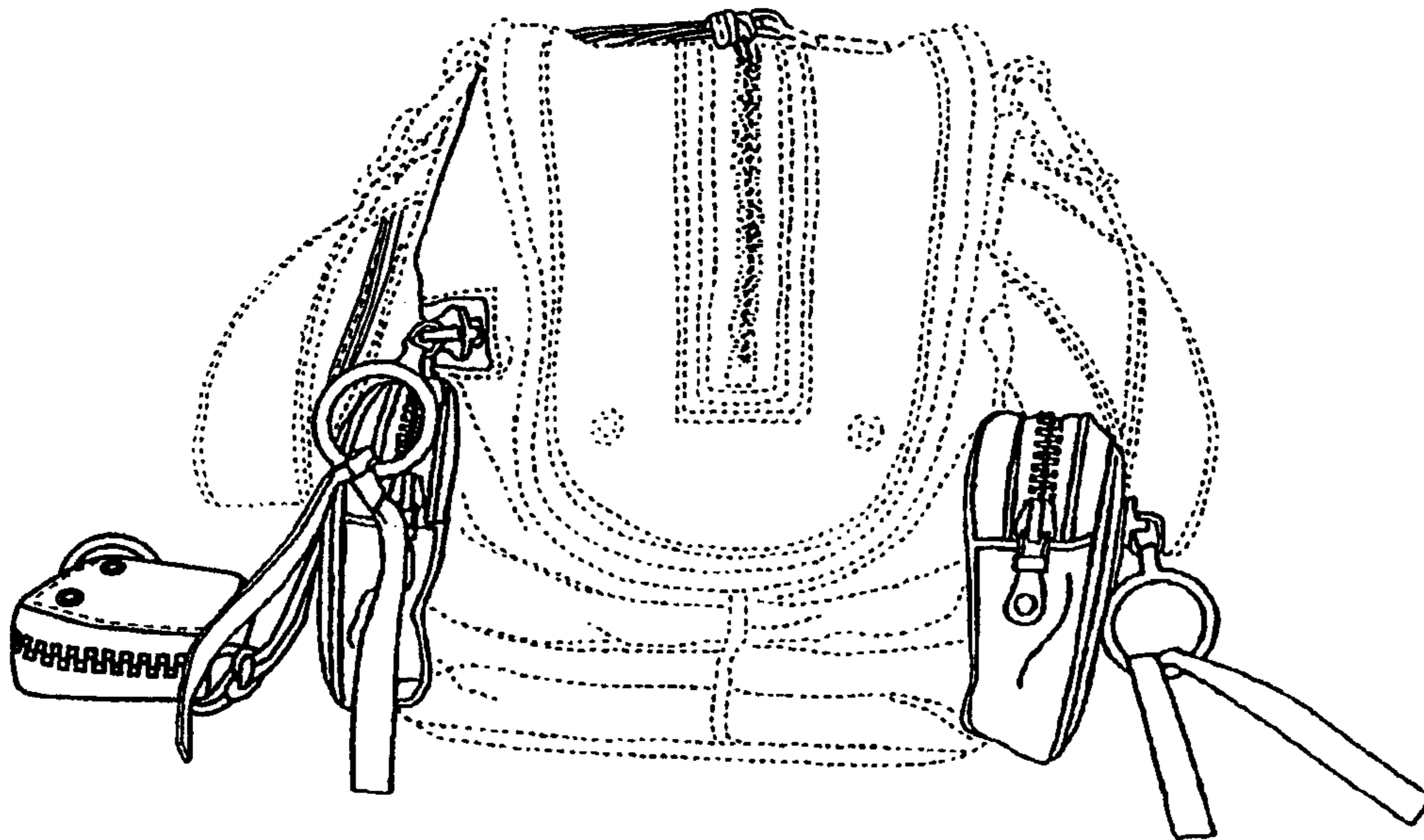

FIG. 6