



US00D572407S

(12) **United States Design Patent**  
**Cook et al.**

(10) **Patent No.:** **US D572,407 S**  
(45) **Date of Patent:** **\*\* Jul. 1, 2008**

(54) **LOTION APPLICATOR**

(75) Inventors: **Nina C. Cook**, Belle Mead, NJ (US);  
**Thomas J. Powers**, Titusville, NJ (US);  
**Alexander J. Sinton**, Doylestown, PA  
(US); **Craig Hidalgo**, Langhorne, PA  
(US)

(73) Assignee: **Distinctive Design, LLC**, Mead, NJ  
(US)

(\*\*) Term: **14 Years**

(21) Appl. No.: **29/293,370**

(22) Filed: **Nov. 20, 2007**

(51) **LOC (8) Cl.** ..... **28-02**

(52) **U.S. Cl.** ..... **D28/7**

(58) **Field of Classification Search** ..... D28/7,  
D28/63, 91.2; D24/119; 15/104.94, 209.1,  
15/210.1; 401/136; 601/138

See application file for complete search history.

(56) **References Cited**

**U.S. PATENT DOCUMENTS**

5,692,261	A	*	12/1997	Lops	.....	15/209.1
D447,279	S	*	8/2001	Altobellis et al.	.....	D28/7
D453,855	S	*	2/2002	Petkus	.....	D28/7
D473,343	S	*	4/2003	Carruba et al.	.....	D28/63
D480,177	S	*	9/2003	Isono et al.	.....	D28/63

D511,021	S	*	10/2005	Angeletta	.....	D28/7
D515,737	S	*	2/2006	Angeletta	.....	D28/7
D518,597	S	*	4/2006	Sommers	.....	D28/7
D552,792	S	*	10/2007	Bargiel et al.	.....	D28/7

\* cited by examiner

*Primary Examiner*—Janice E. Seeger

*Assistant Examiner*—Zenia I Bennett

(74) *Attorney, Agent, or Firm*—Amster, Rothstein &  
Ebenstein LLP

(57) **CLAIM**

The ornamental design for a lotion applicator, as shown and described.

**DESCRIPTION**

FIG. 1 is a first perspective view of the lotion applicator showing my new design;

FIG. 2 is a second perspective view of the lotion applicator of FIG. 1;

FIG. 3 is a front plan view thereof;

FIG. 4 is a rear plan view thereof;

FIG. 5 is a side view thereof;

FIG. 6 is another side view thereof;

FIG. 7 is a top plan view thereof; and,

FIG. 8 is a bottom plan view thereof.

**1 Claim, 8 Drawing Sheets**

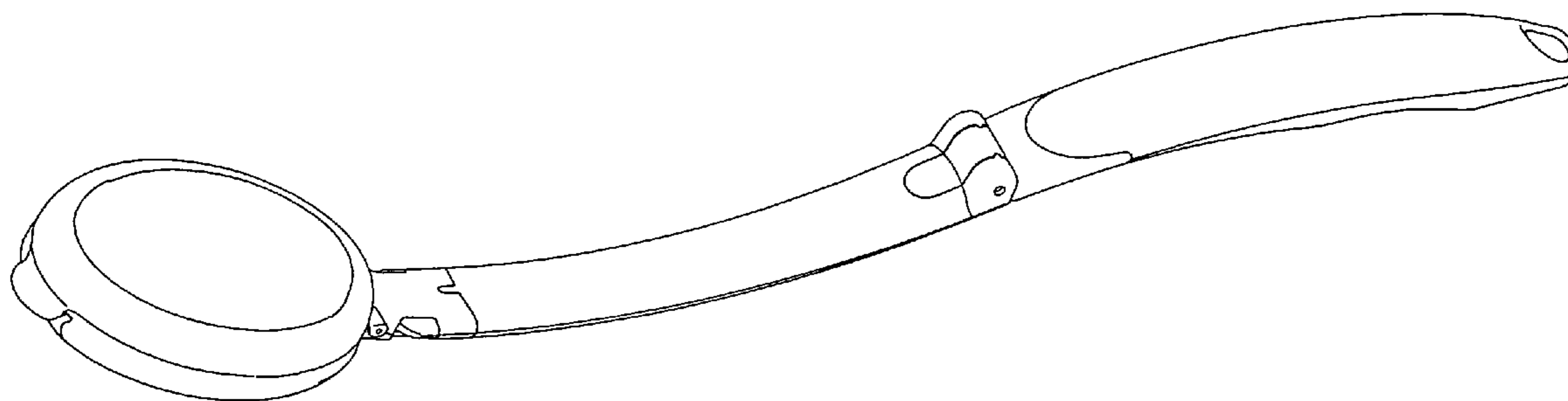

Fig. 1

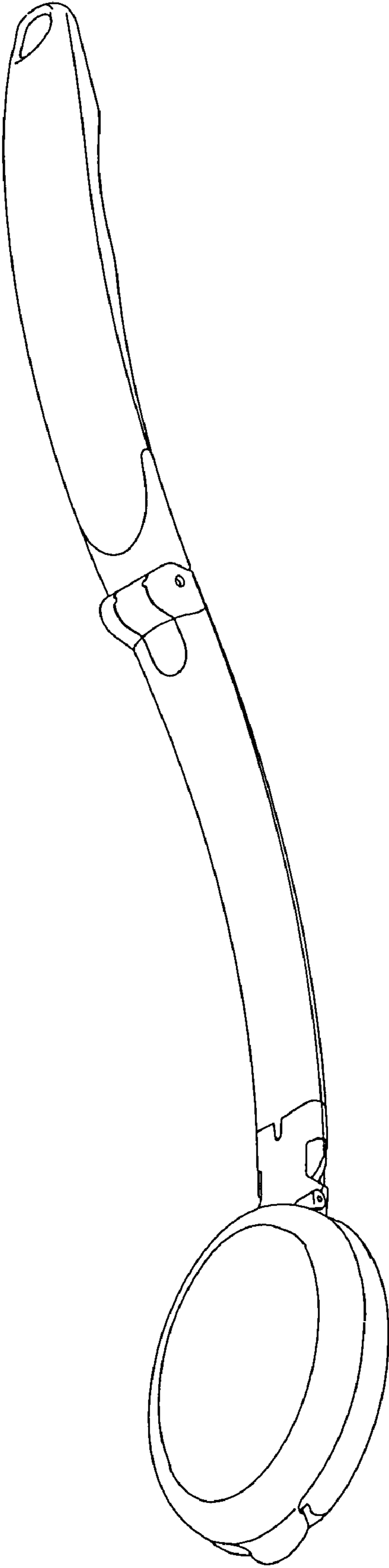
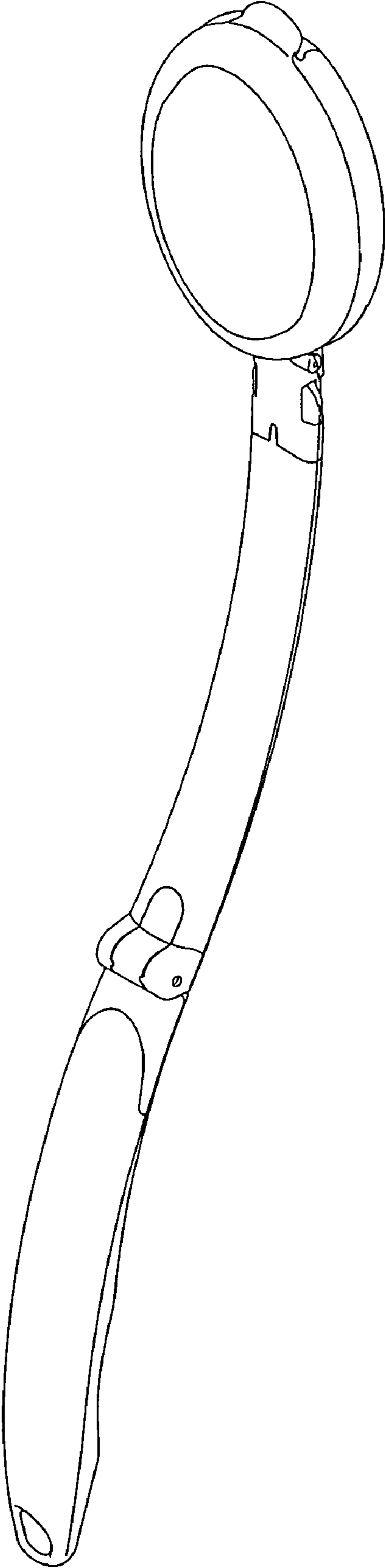

Fig. 2



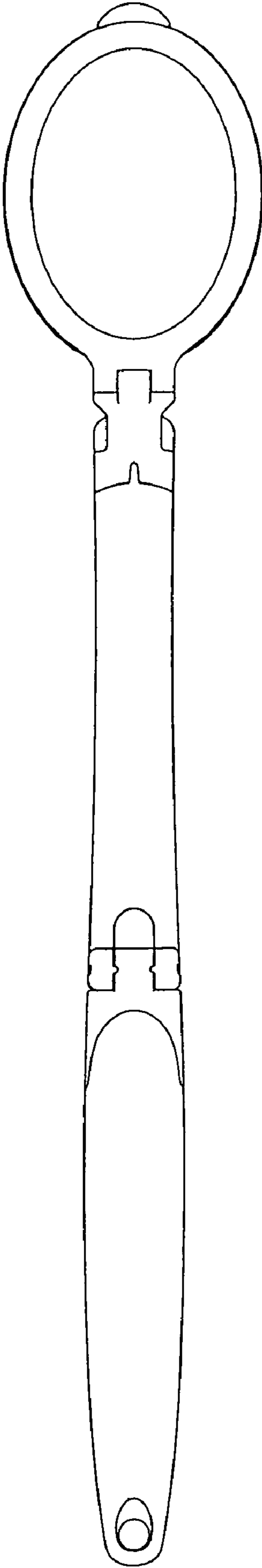

FIG. 3

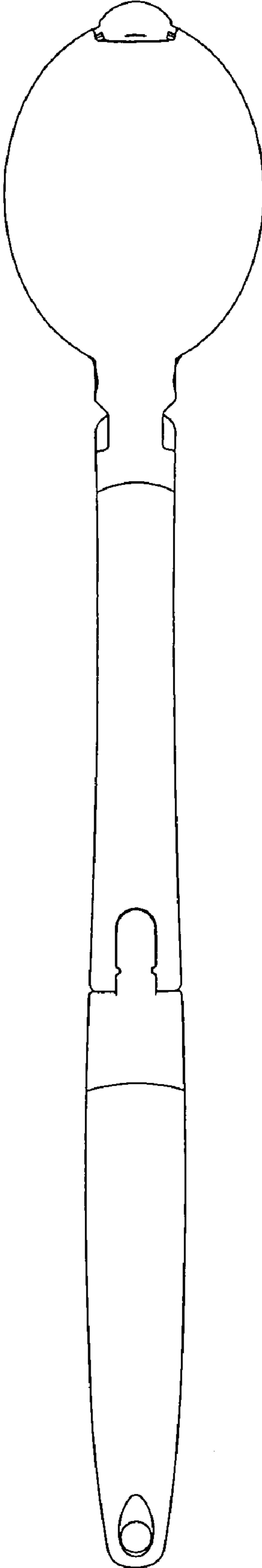

Fig. 4

Fig. 5

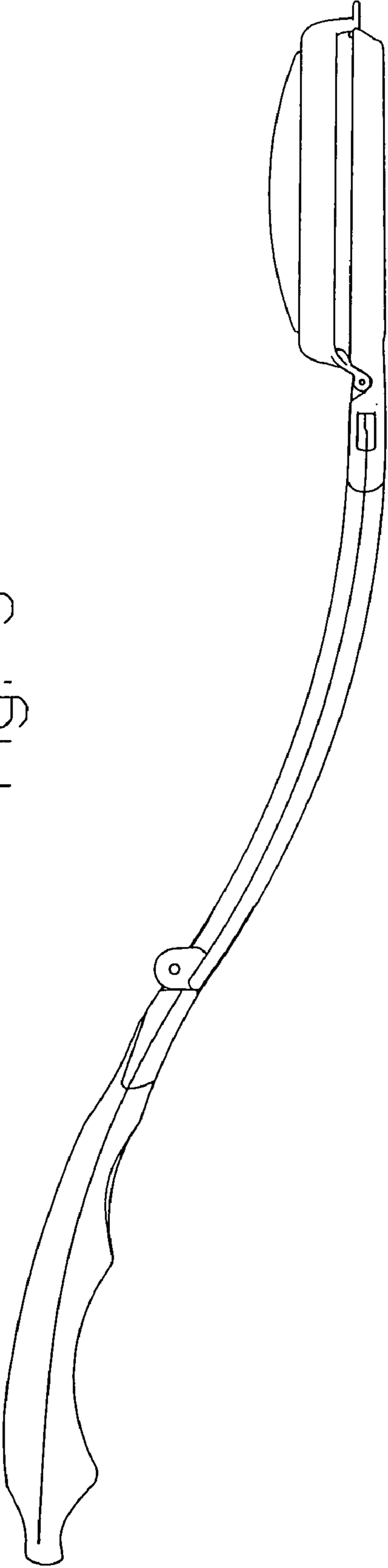

Fig. 6

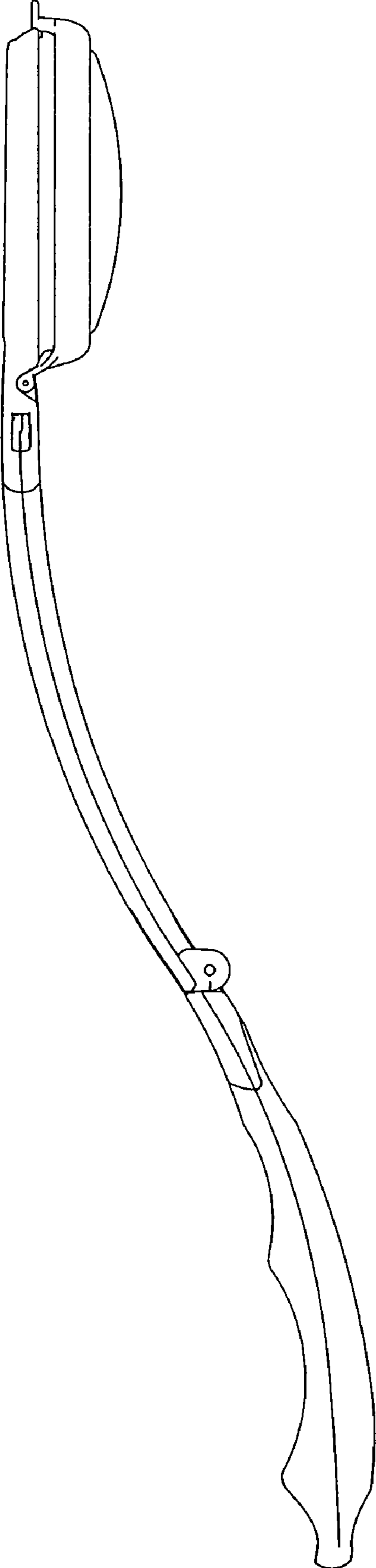

FIG. 7

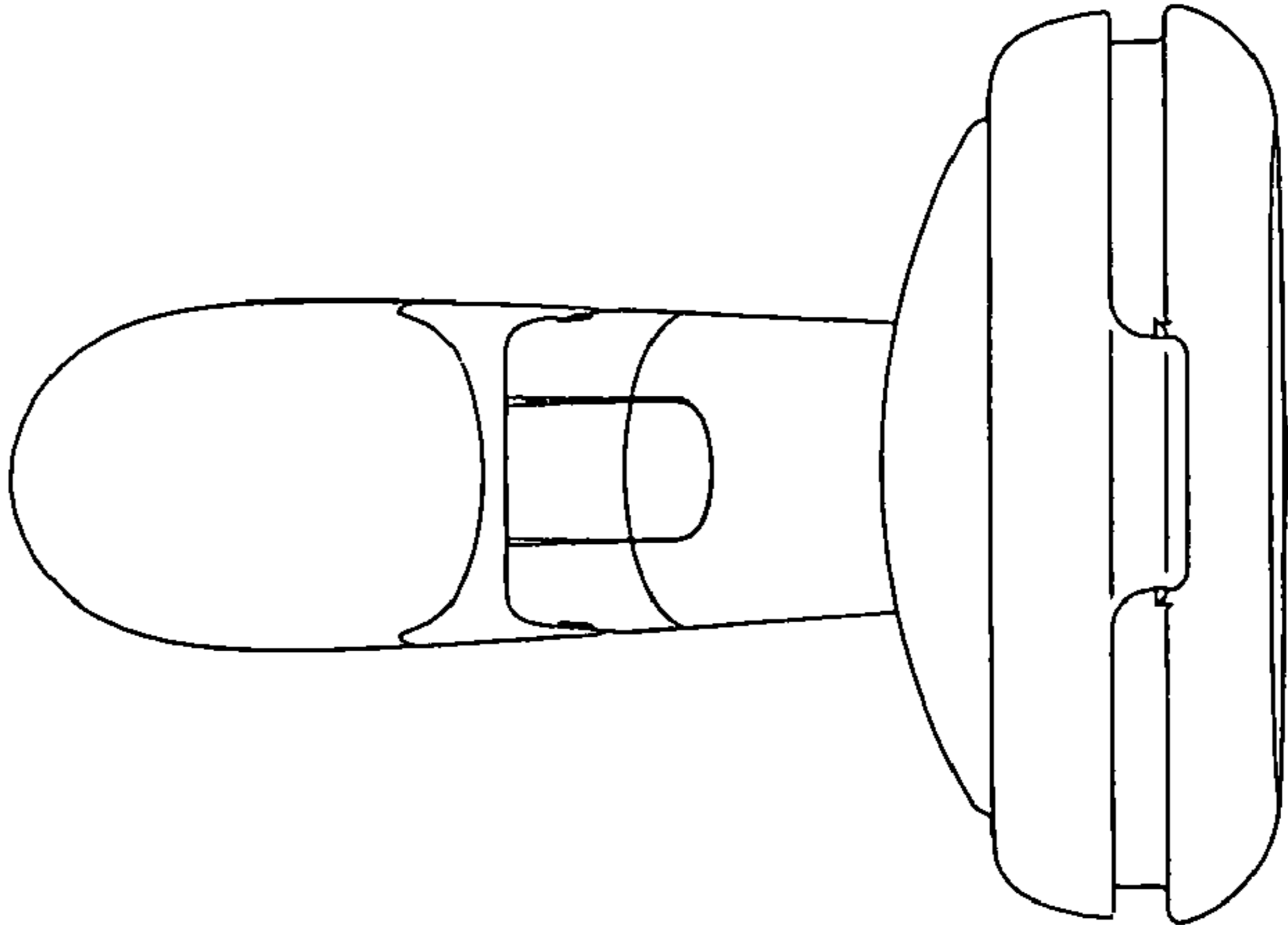



FIG. 8

