



US00D572368S

(12) **United States Design Patent**  
**Kliegman et al.**

(10) **Patent No.:** **US D572,368 S**

(45) **Date of Patent:** **\*\* Jul. 1, 2008**

(54) **PACIFIER**

(75) Inventors: **Adriana Kliegman**, New York, NY  
(US); **Diana B. Sierra**, Hackensack, NJ  
(US)

(73) Assignee: **Playtex Products, Inc.**, Westport, CT  
(US)

(\*\*) Term: **14 Years**

(21) Appl. No.: **29/259,285**

(22) Filed: **May 5, 2006**

(51) **LOC (8) Cl.** ..... **24-04**

(52) **U.S. Cl.** ..... **D24/194**

(58) **Field of Classification Search** ..... D24/193-199,  
D24/215; D7/393-4; D9/436, 456, 526;  
215/11.1-11.6, 387, 392; 248/102-107;  
606/234-236; 24/301

See application file for complete search history.

(56) **References Cited**

**U.S. PATENT DOCUMENTS**

3,267,937	A	8/1966	Verschoor	
D267,116	S	11/1982	Bobelis et al.	
D273,991	S *	5/1984	Moore	D24/194
4,545,378	A *	10/1985	Chrones	606/236
D303,839	S	10/1989	Fitzpatrick et al.	
D326,919	S	6/1992	Geitner et al.	
D334,064	S	3/1993	Fitzpatrick	
D340,525	S *	10/1993	Rohrig	D24/194
5,403,349	A *	4/1995	Rohrig	606/234
D380,836	S *	7/1997	Fitzpatrick et al.	D24/194
5,653,731	A *	8/1997	Rohrig	606/234
D391,641	S *	3/1998	Fields et al.	D24/194

D393,074	S *	3/1998	Fields et al.	D24/194
D404,137	S	1/1999	Underwood et al.	
D413,387	S *	8/1999	Fitzpatrick et al.	D24/194
D414,267	S *	9/1999	Calandro, Jr.	D24/194
D430,675	S *	9/2000	Roehrig	D24/194
D450,126	S *	11/2001	Fitzpatrick et al.	D24/194
D453,379	S *	2/2002	Roehrig	D24/194
6,695,869	B2 *	2/2004	Fitzpatrick et al.	606/234
D487,929	S *	3/2004	Liu et al.	D24/194
6,905,507	B2 *	6/2005	Hinshaw	606/235
D532,521	S *	11/2006	Struckmeier	D24/194
D541,422	S *	4/2007	Pils et al.	D24/194
D547,456	S *	7/2007	Ramos et al.	D24/194
D558,885	S *	1/2008	Trizzino	D24/194

\* cited by examiner

*Primary Examiner*—Robert M. Spear  
*Assistant Examiner*—Susan E Krakower

(74) *Attorney, Agent, or Firm*—Ohlandt, Greeley, Ruggiero & Perle, L.L.P

(57) **CLAIM**

The ornamental design for a pacifier, as shown and described.

**DESCRIPTION**

FIG. 1 is a front perspective view of a pacifier showing my design;

FIG. 2 is a rear perspective view thereof;

FIG. 3 is a front view thereof;

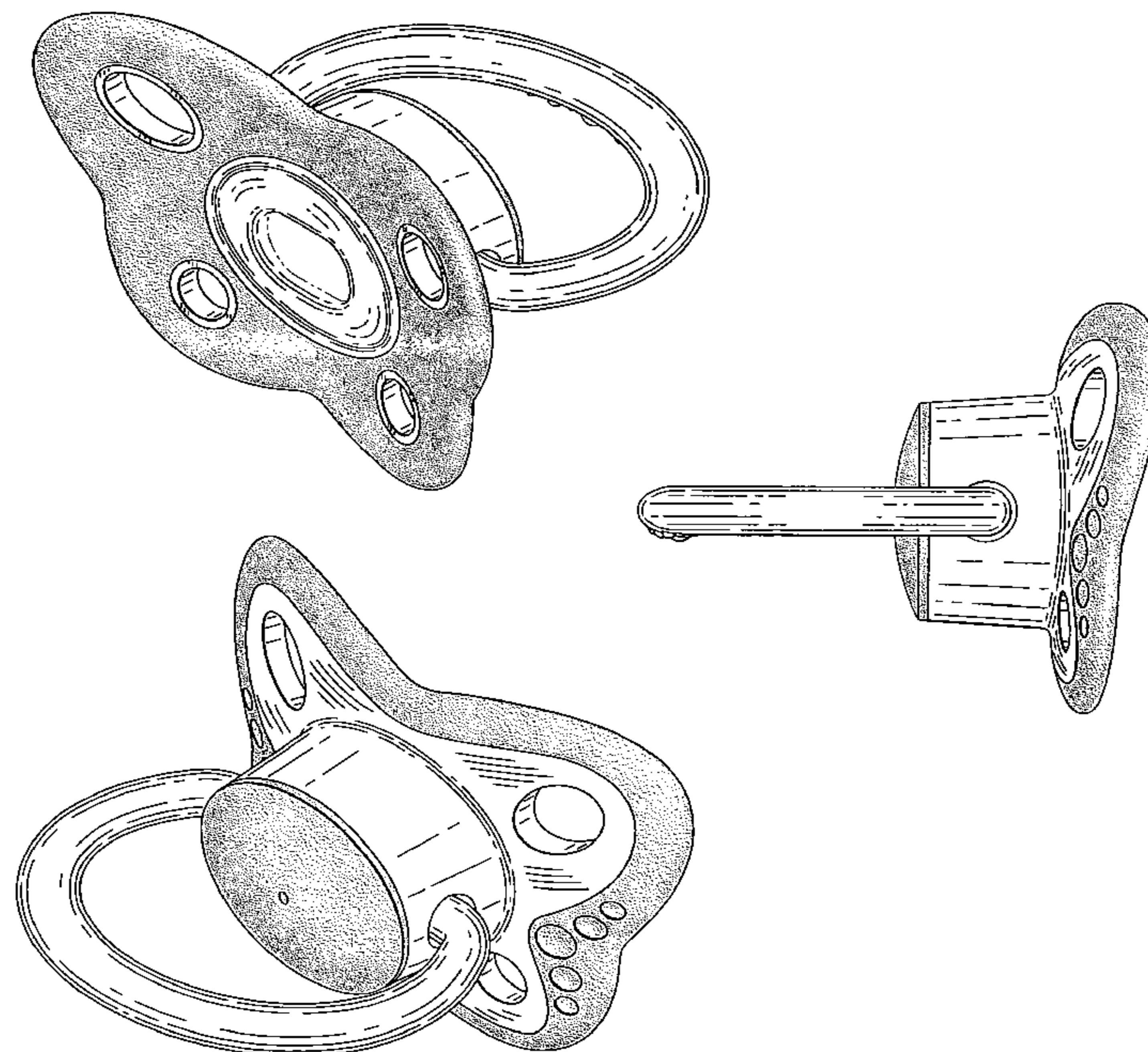
FIG. 4 is a rear view thereof;

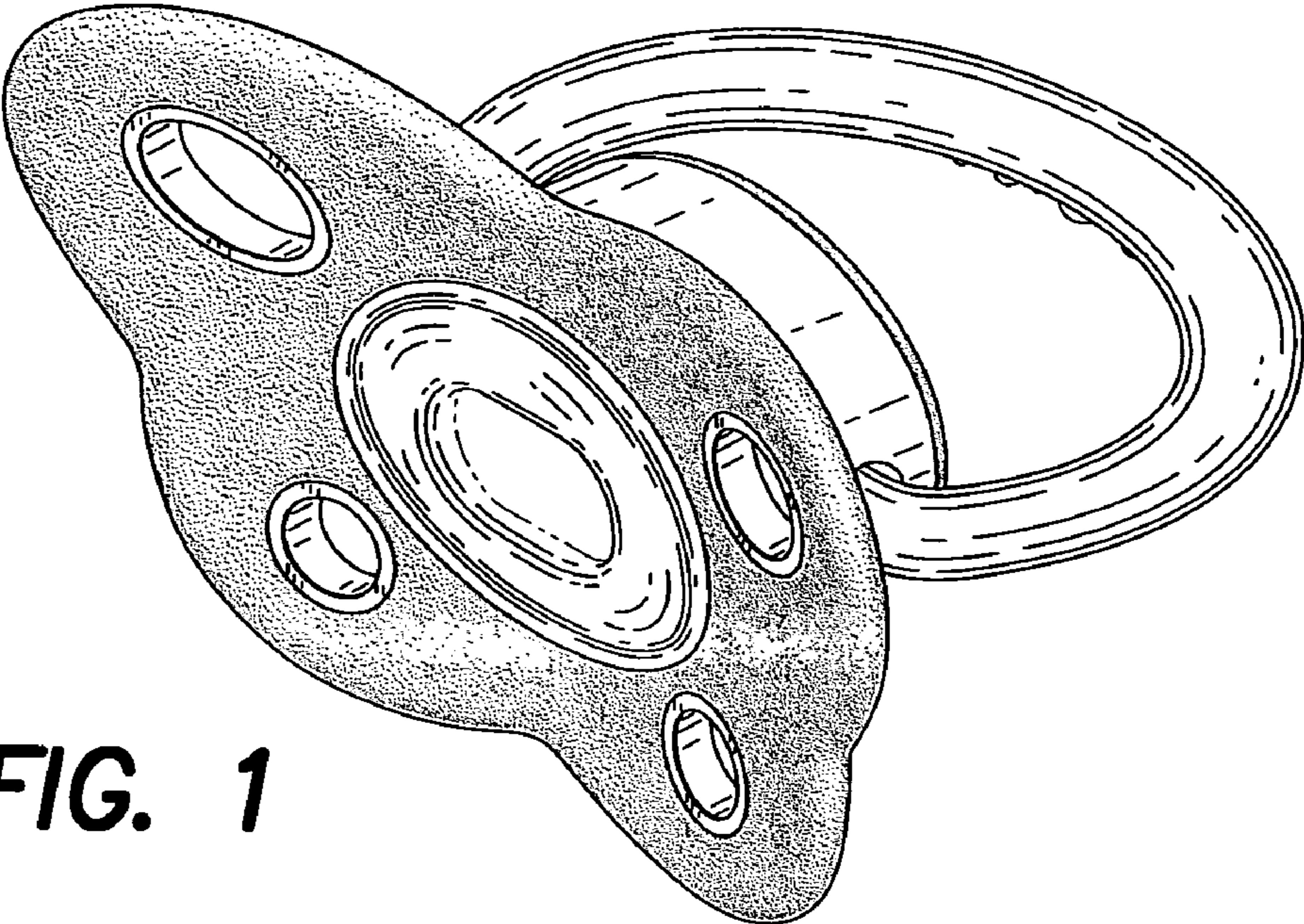
FIG. 5 is a side view thereof, the opposite side being identical;

FIG. 6 is a top view thereof; and,

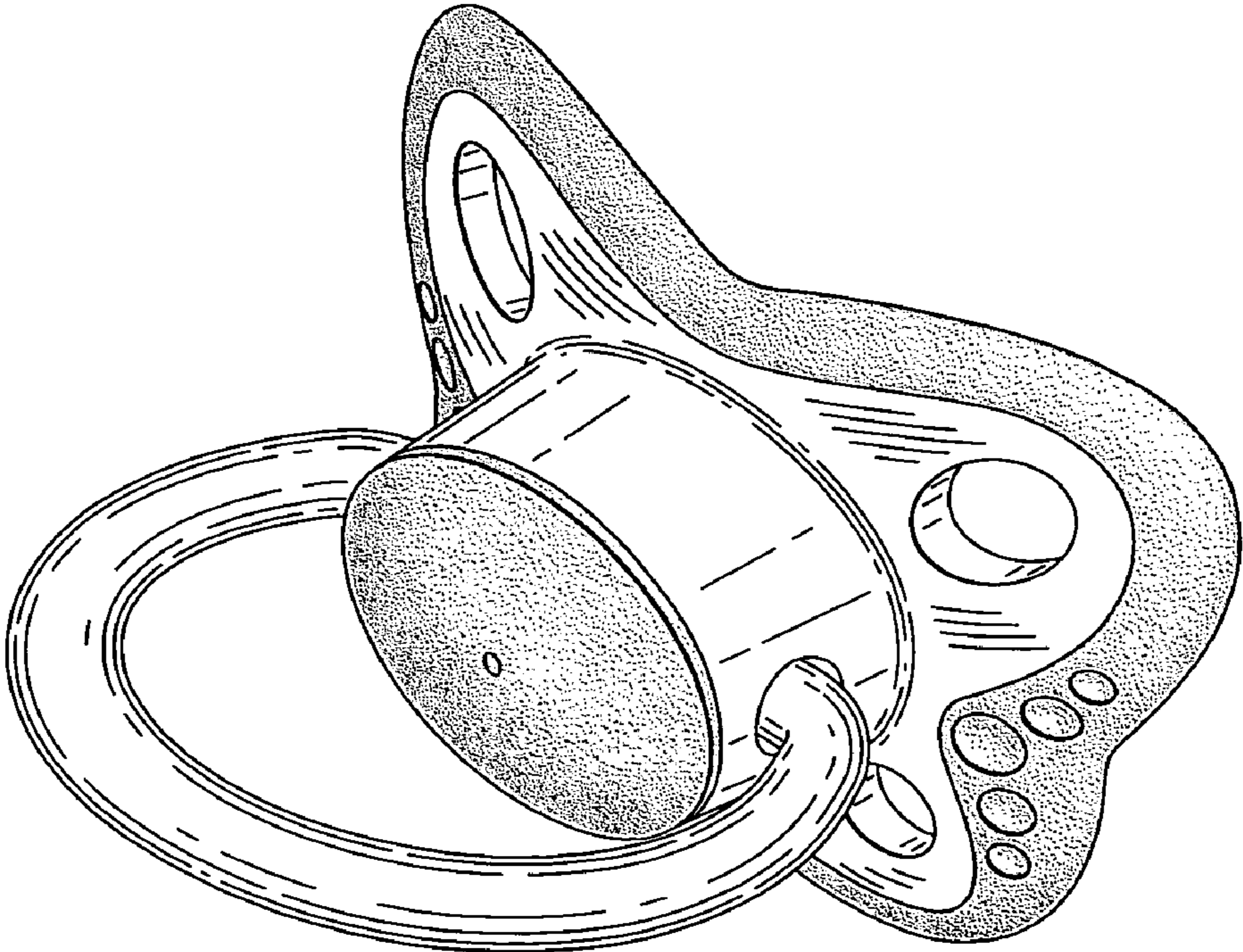
FIG. 7 is a bottom view thereof.

**1 Claim, 3 Drawing Sheets**



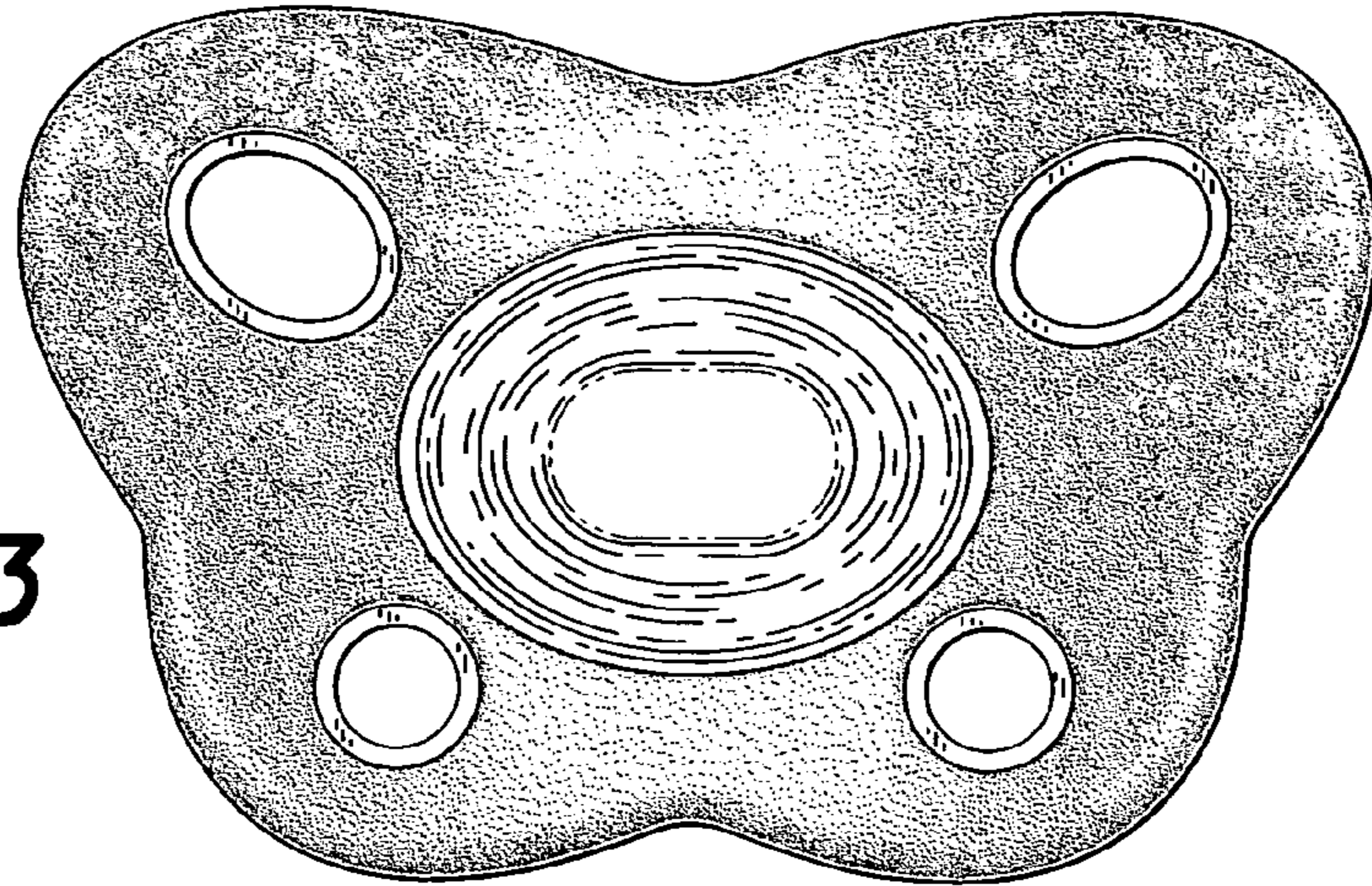


**FIG. 1**

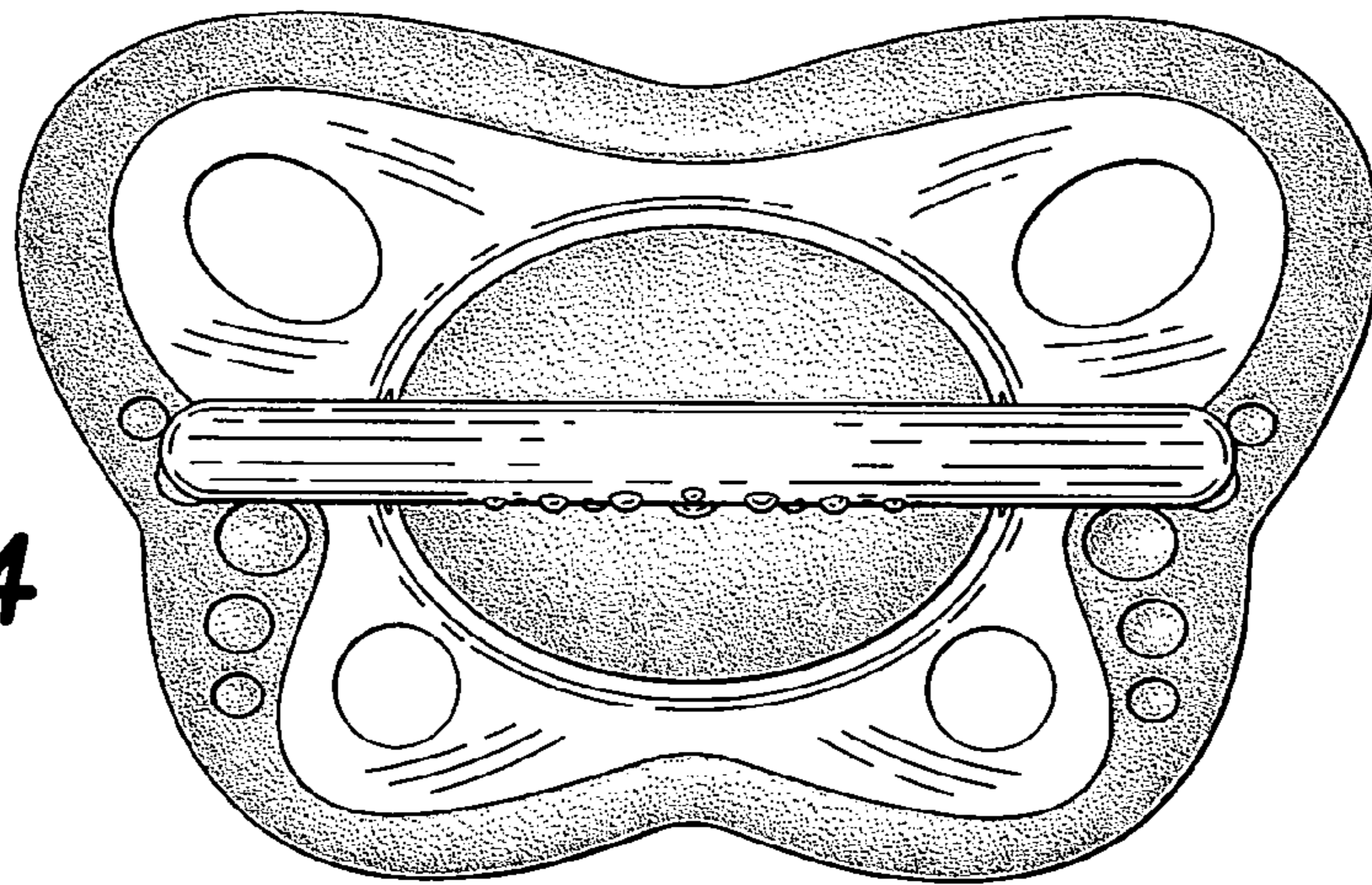


**FIG. 2**

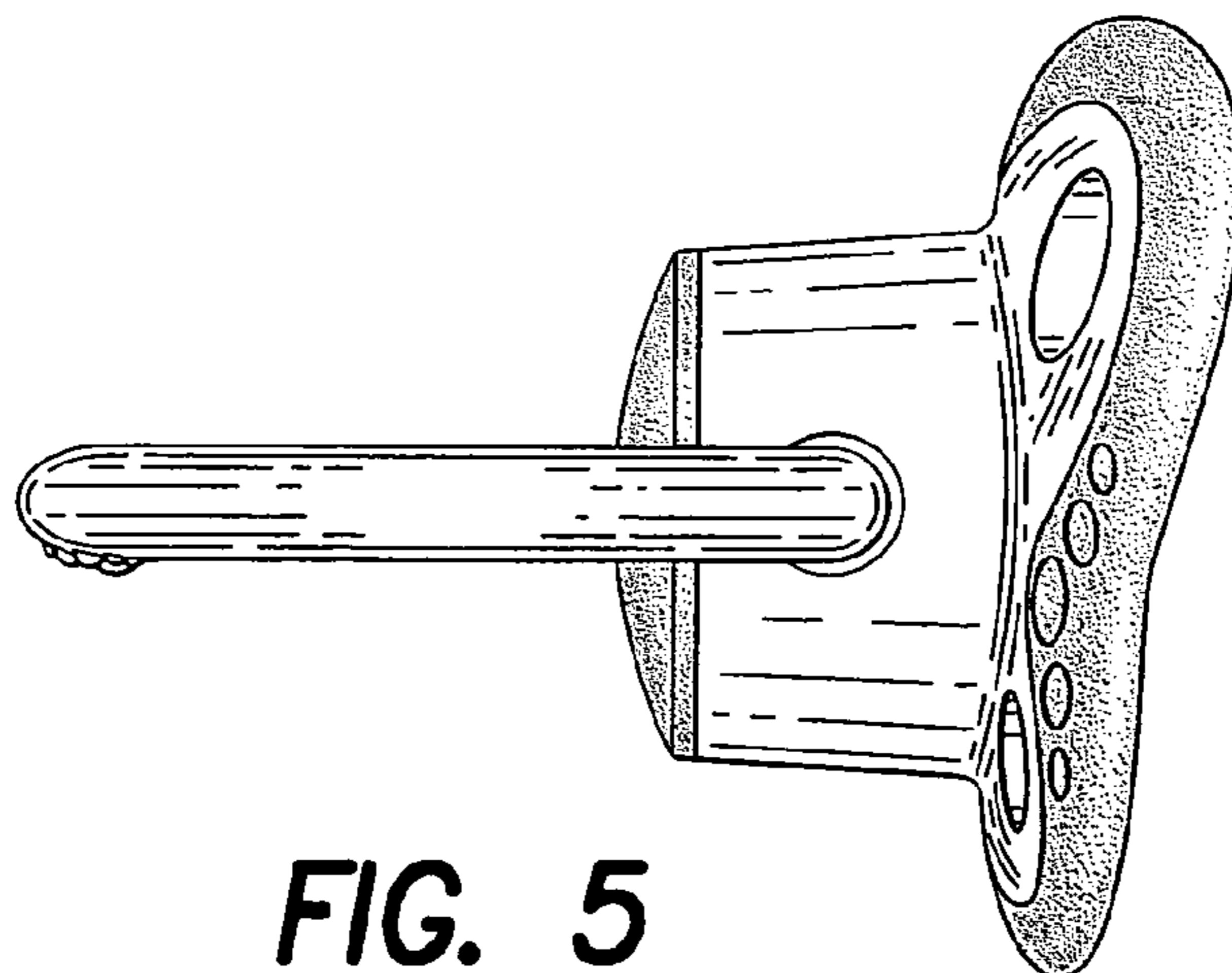
**FIG. 3**

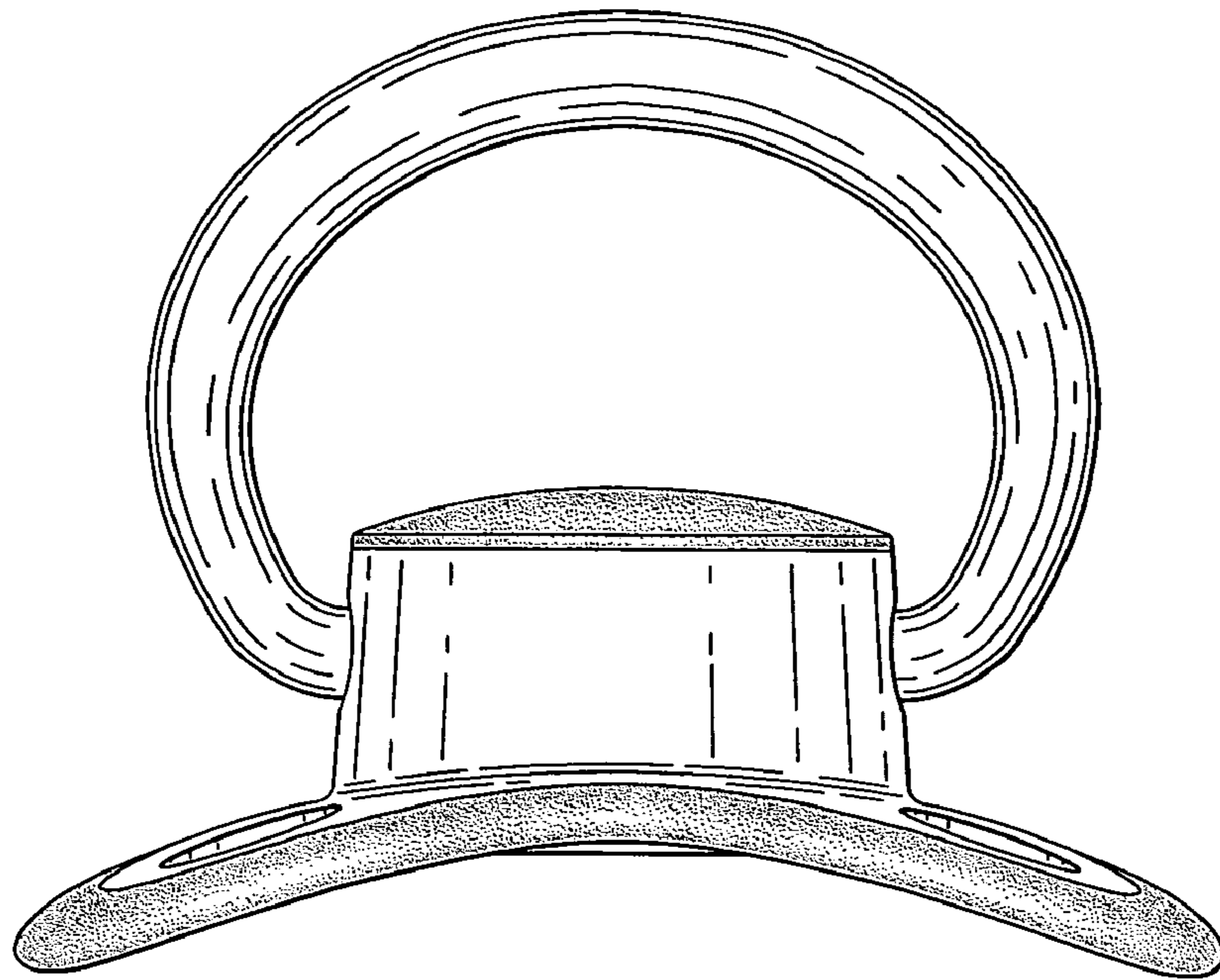


**FIG. 4**

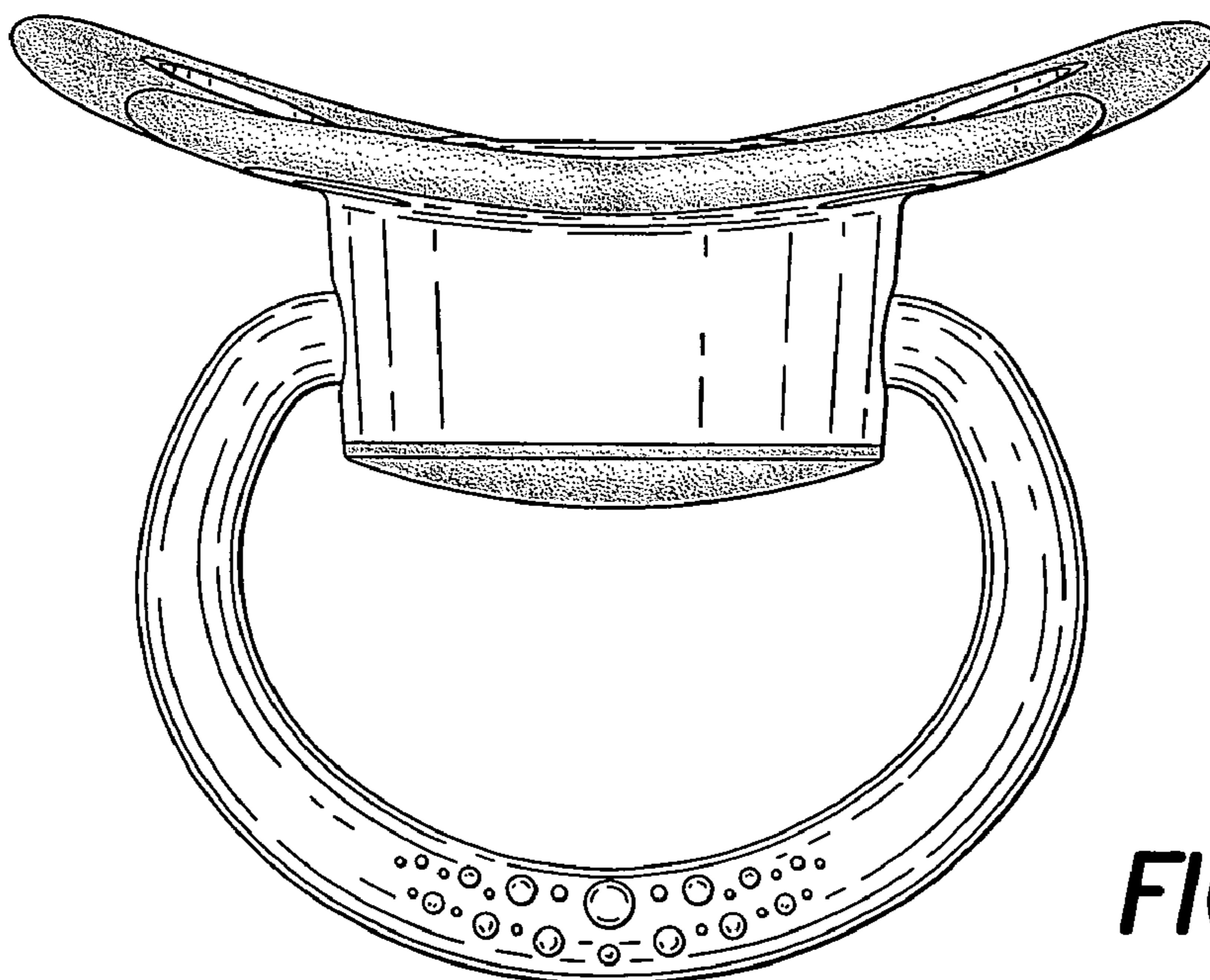


**FIG. 5**





**FIG. 6**



**FIG. 7**