



US00D572359S

(12) **United States Design Patent**  
**Zhuang**

(10) **Patent No.:** **US D572,359 S**  
(45) **Date of Patent:** **\*\* Jul. 1, 2008**

(54) **UPRIGHT PERSONAL FAN**

(76) Inventor: **York Zhuang**, A2 Building, Dahe Industrial Area, Huanguan South Road, Guan Lan, Shenzhen (CN) 518110

(\*\*) Term: **14 Years**

(21) Appl. No.: **29/292,458**

(22) Filed: **Oct. 15, 2007**

(51) **LOC (8) Cl.** ..... **23-04**

(52) **U.S. Cl.** ..... **D23/411**

(58) **Field of Classification Search** ..... D23/378,  
D23/380, 381, 382, 411, 413, 335-336; 416/5,  
416/246, 247 R

See application file for complete search history.

(56) **References Cited**

**U.S. PATENT DOCUMENTS**

2,626,742 A *	1/1953	Turner	.....	416/120
D352,105 S *	11/1994	Chen	.....	D23/380
D457,618 S *	5/2002	Lee et al.	.....	D23/382
D541,404 S *	4/2007	Russak et al.	.....	D23/380
D541,929 S *	5/2007	Russak et al.	.....	D23/411

\* cited by examiner

*Primary Examiner*—Lisa Lichtenstein

(74) *Attorney, Agent, or Firm*—Basil E. Demeur; Alan Samlan; David J. Hurley

(57) **CLAIM**

The ornamental design for an upright personal fan, as shown and described.

**DESCRIPTION**

FIG. 1 is a front perspective view showing the upright fan of the present invention;

FIG. 2 is a rear perspective view showing the upright fan;

FIG. 3 is a front elevational view of the upright fan;

FIG. 4 is a rear elevational view of the upright fan;

FIG. 5 is a side elevational view of the upright fan;

FIG. 6 is a side elevational view of the opposed side of the upright fan;

FIG. 7 is a top view of the upright fan; and,

FIG. 8 is a bottom view of the upright fan.

The broken line showing of the fan grills is included for the purpose of illustrating environmental structure and forms no part of the claimed design.

**1 Claim, 8 Drawing Sheets**

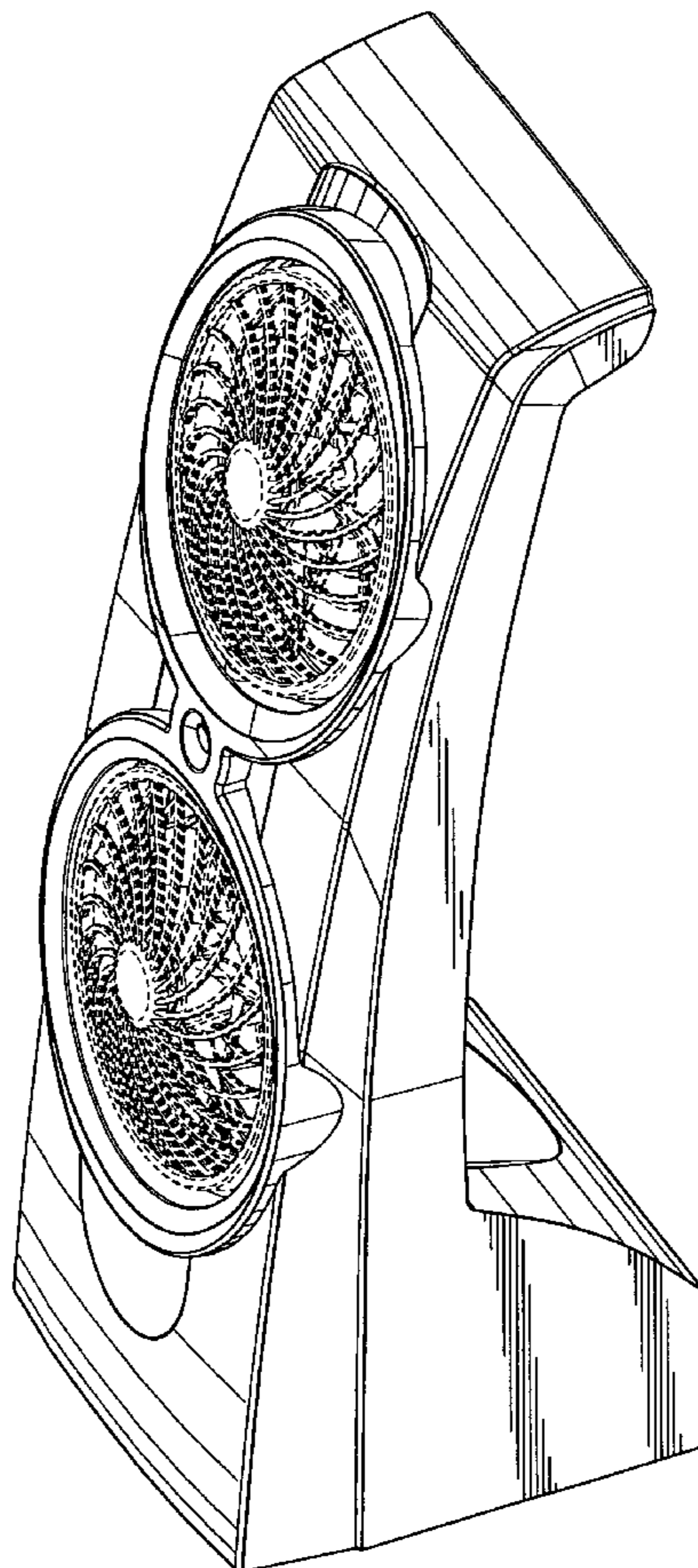

Fig. 1

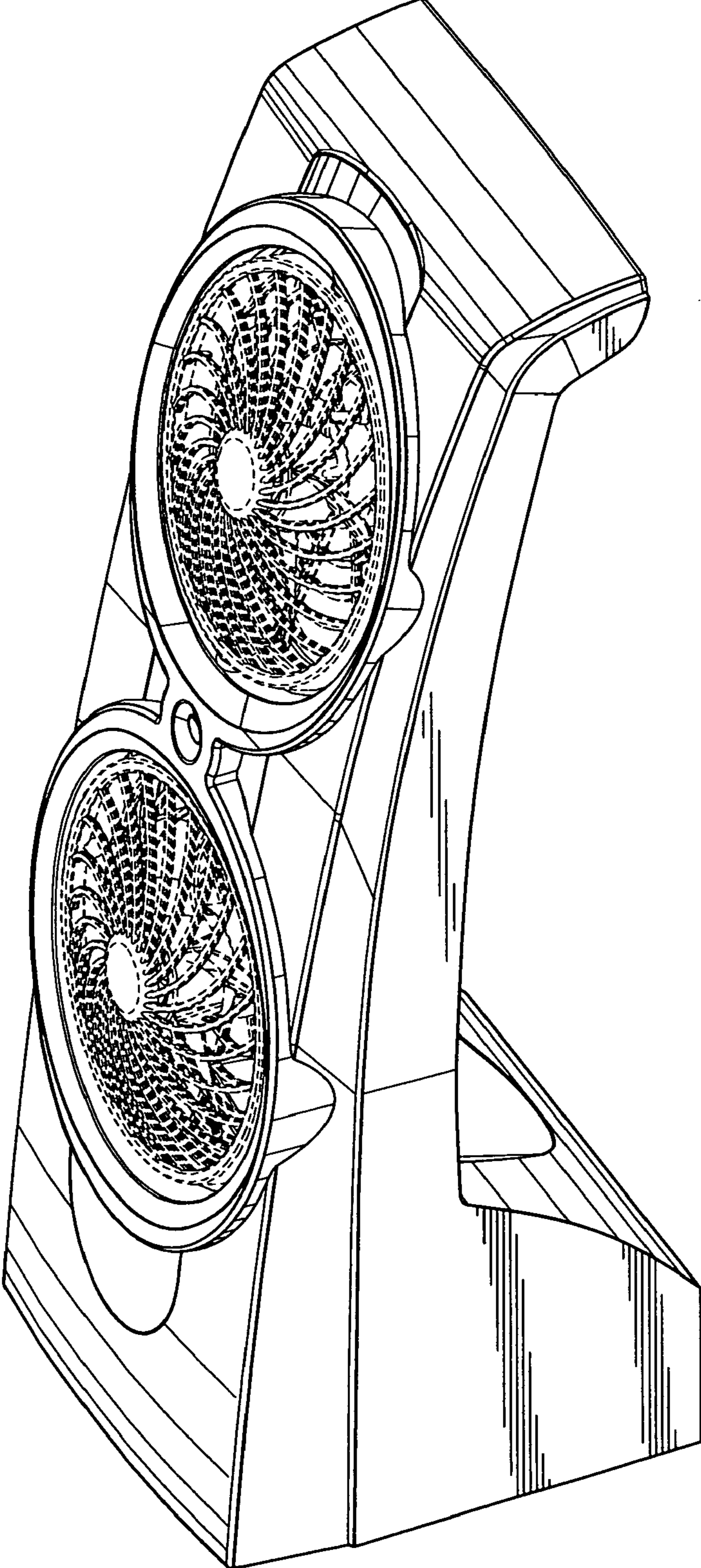
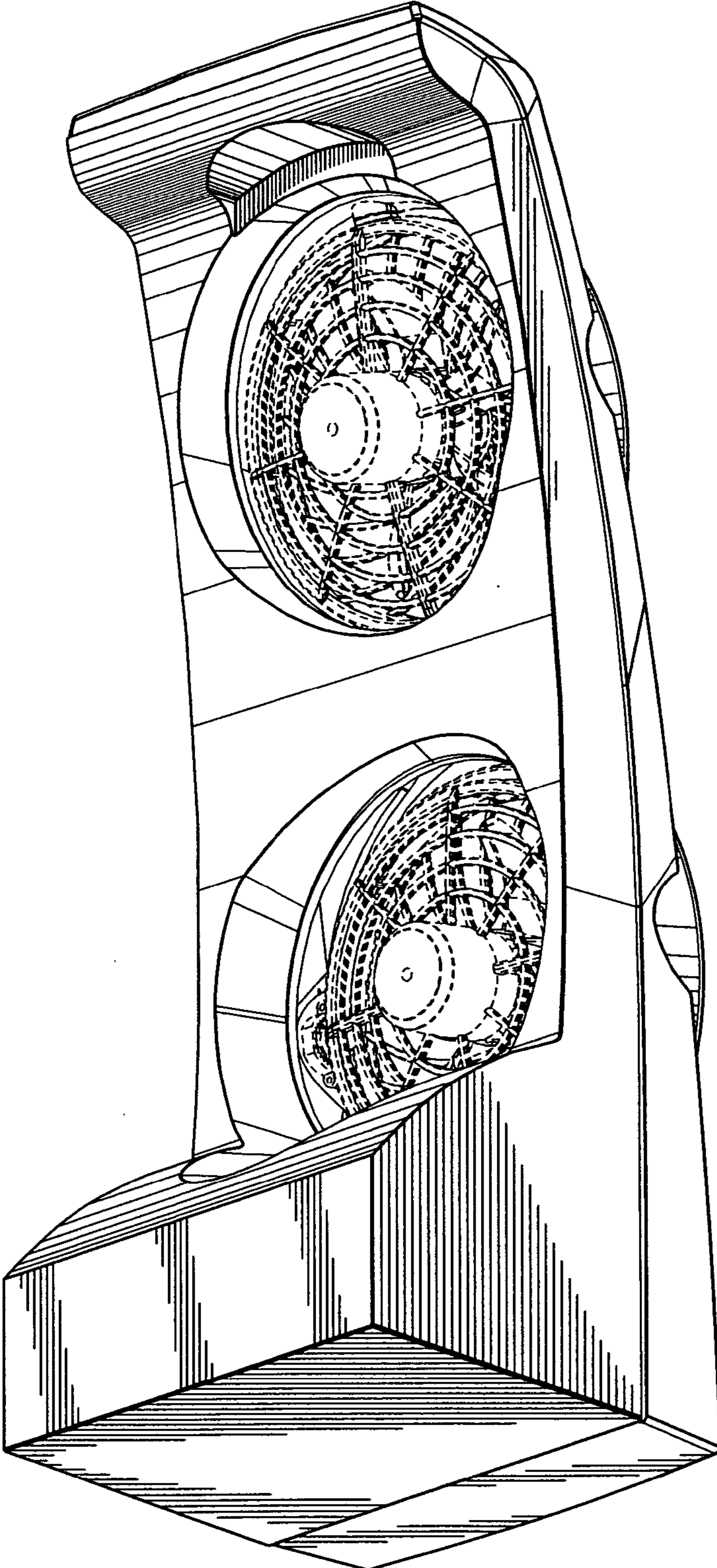
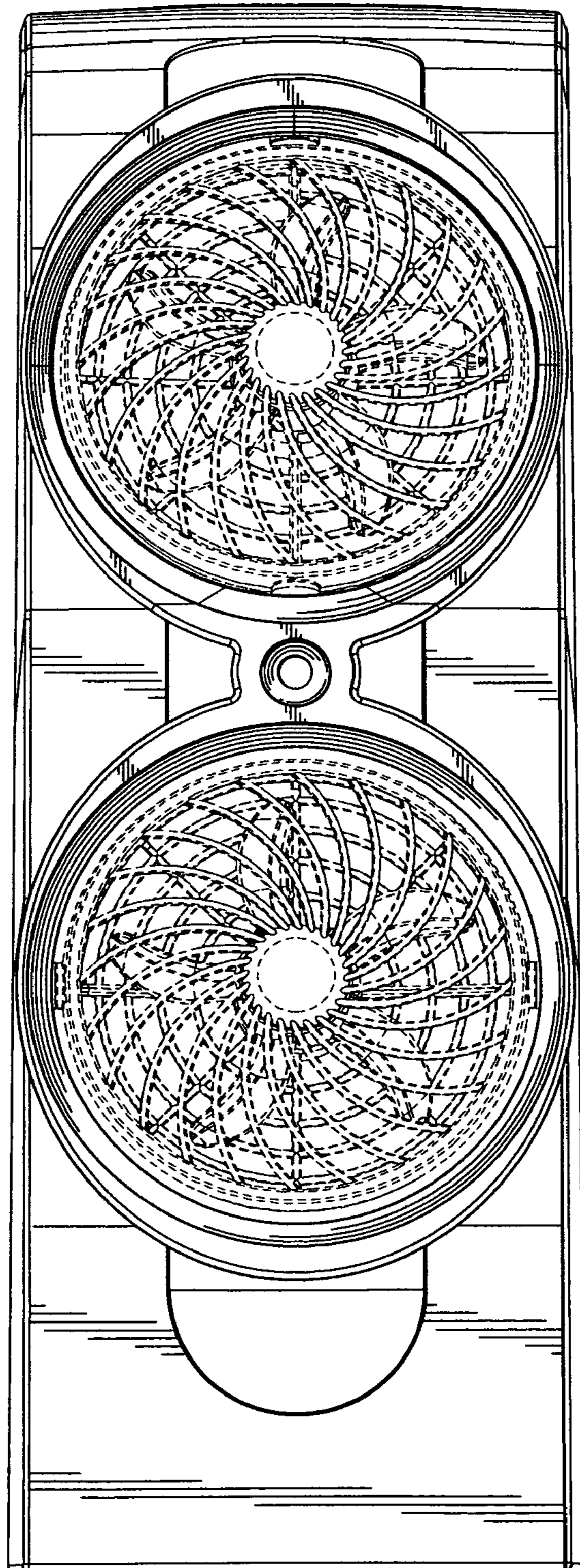

Fig. 2



**Fig. 3**



**Fig. 4**

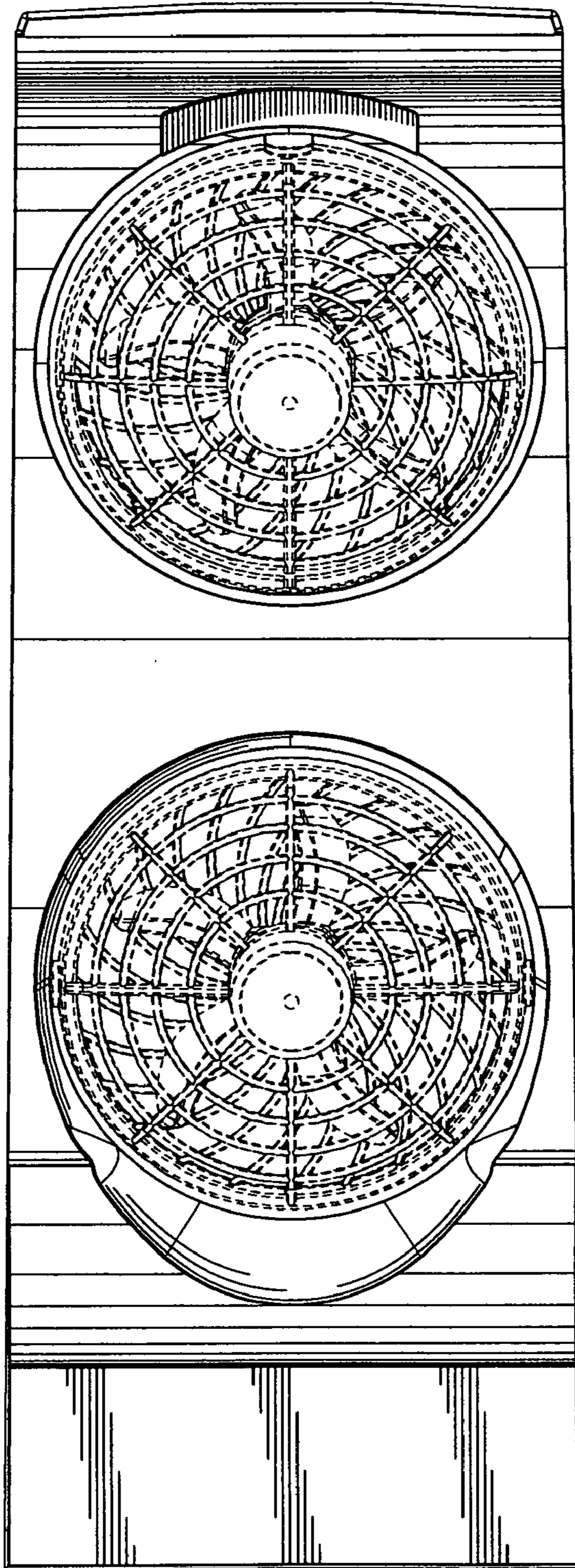

**Fig. 5**

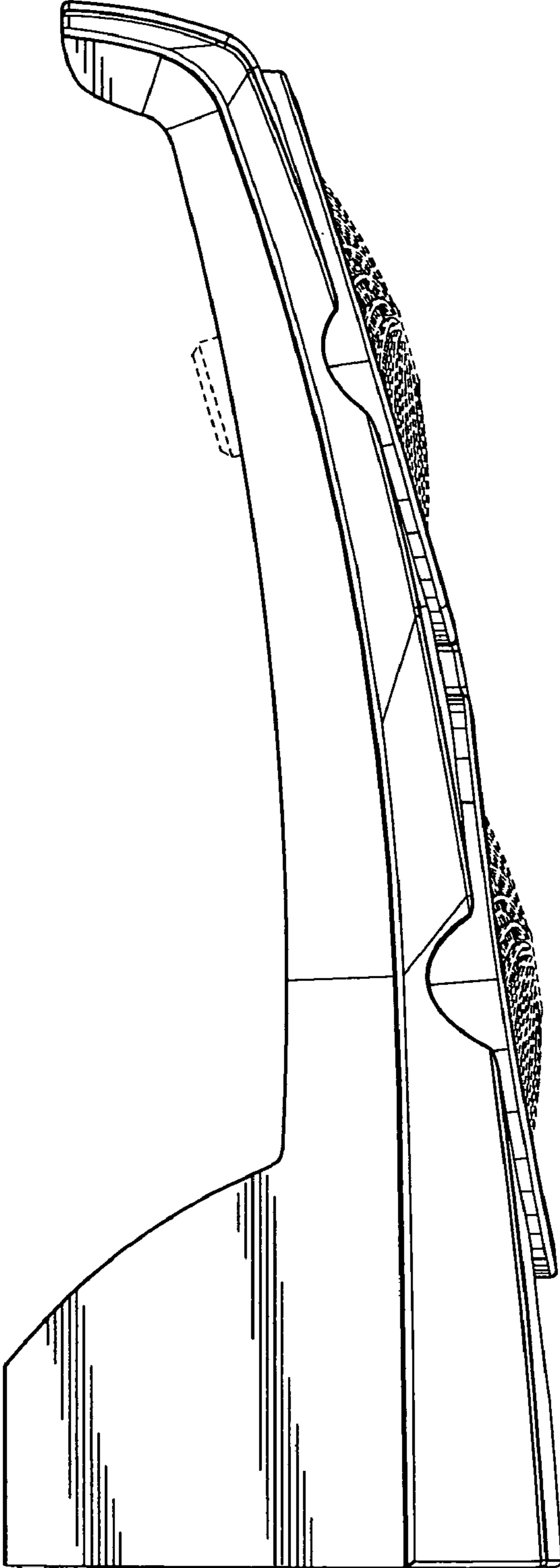

**Fig. 6**

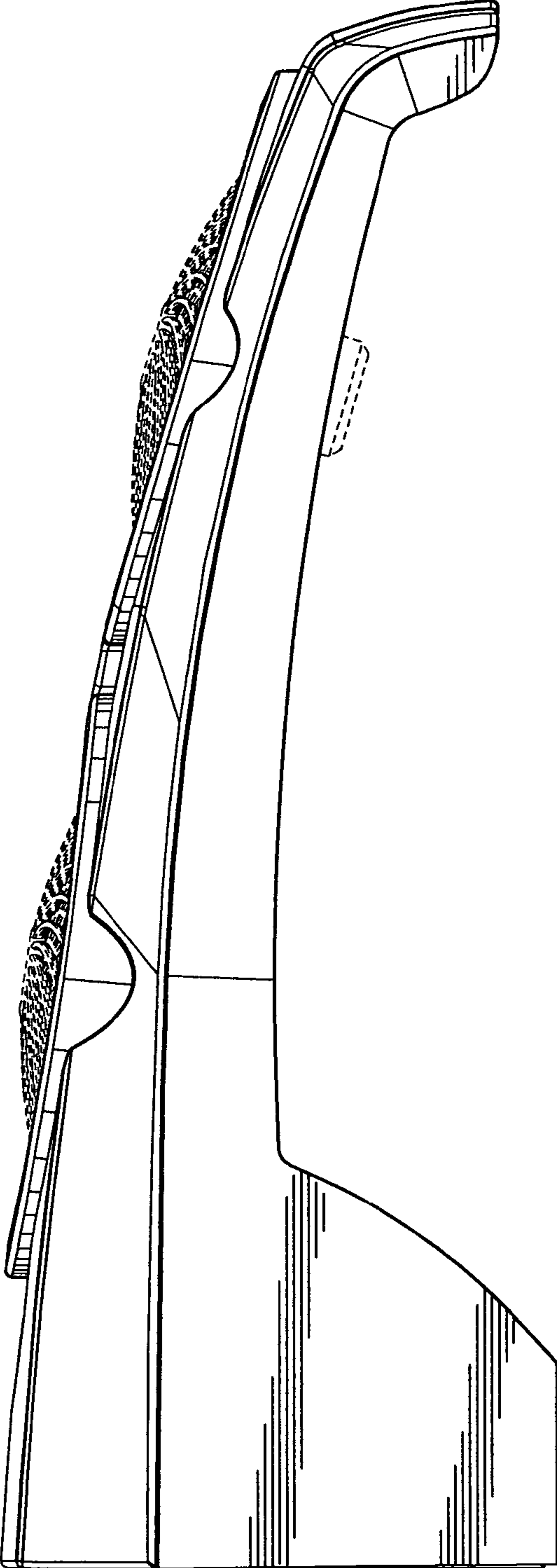

**Fig. 7**

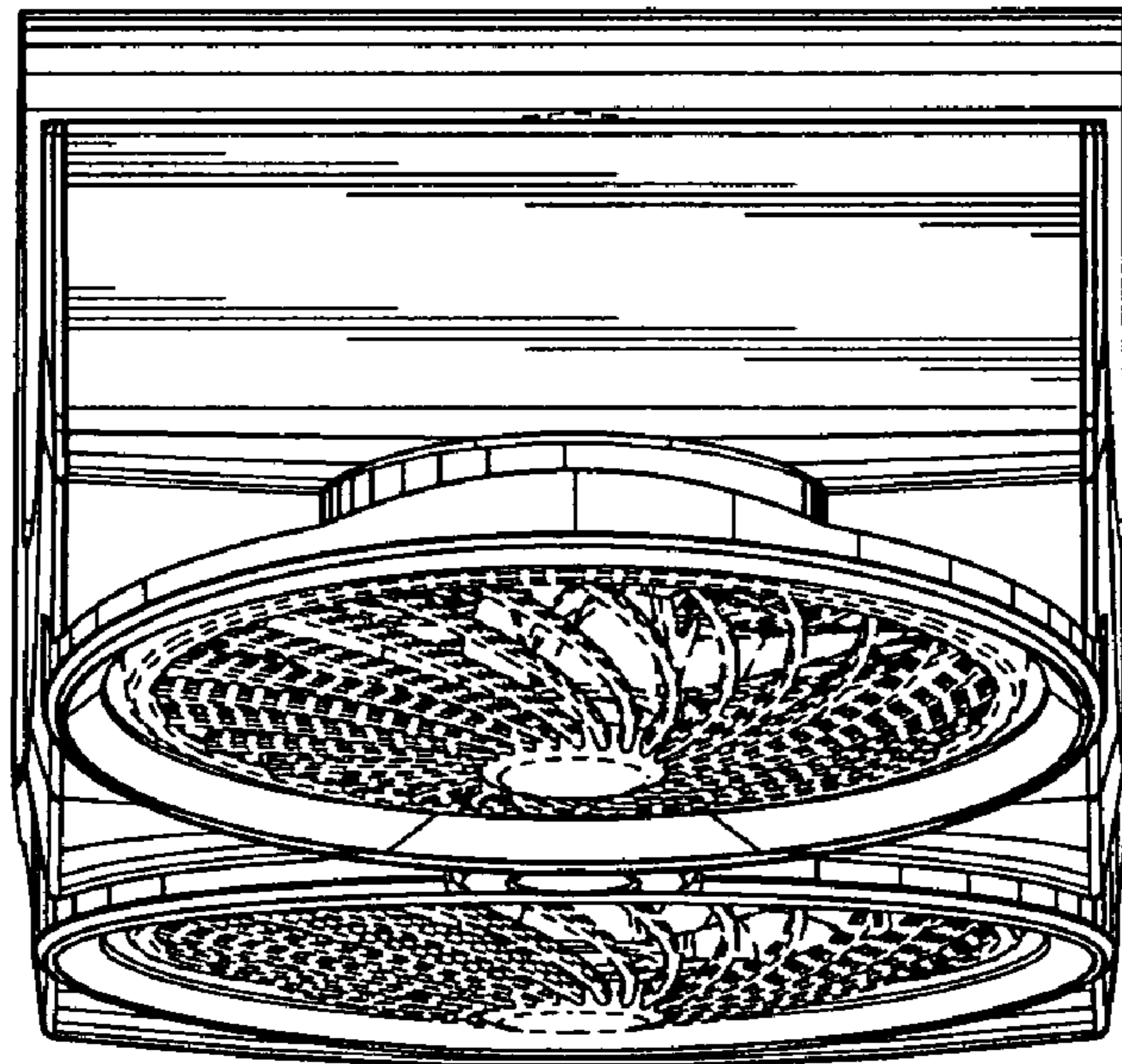



**Fig. 8**

