



US00D572338S

(12) **United States Design Patent**
Hung

(10) **Patent No.:** **US D572,338 S**

(45) **Date of Patent:** **** Jul. 1, 2008**

(54) **WATER SPRAY GUN**

D548,392 S * 8/2007 Lo et al. D23/226
D553,712 S * 10/2007 Chih D23/226

(75) Inventor: **Shih Yuan Hung**, Changhua Hsien (TW)

* cited by examiner

(73) Assignee: **Ruey Ryh Enterprise Co., Ltd.**,
Changhua Hsien (TW)

Primary Examiner—Robin V Webster
(74) *Attorney, Agent, or Firm*—Troxell Law Office, PLLC

(**) Term: **14 Years**

(57) **CLAIM**

(21) Appl. No.: **29/287,620**

The ornamental design for the “water spray gun,” as shown and described.

(22) Filed: **Aug. 30, 2007**

(51) **LOC (8) Cl.** **23-01**

(52) **U.S. Cl.** **D23/223**

(58) **Field of Classification Search** D23/213,
D23/223, 226; 239/525–526, 532
See application file for complete search history.

DESCRIPTION

FIG. 1 is a perspective view of a water spray gun showing my new design;

FIG. 2 is a front view thereof;

FIG. 3 is a rear view thereof;

FIG. 4 is a left side view thereof;

FIG. 5 is a right side view thereof;

FIG. 6 is a top view thereof; and,

FIG. 7 is a bottom view thereof.

(56) **References Cited**

U.S. PATENT DOCUMENTS

- 5,566,886 A * 10/1996 Wang 239/394
- 5,806,770 A * 9/1998 Wang 239/391
- D422,054 S * 3/2000 Hsin-Fa D23/226
- D458,984 S * 6/2002 Chen D23/226

1 Claim, 7 Drawing Sheets

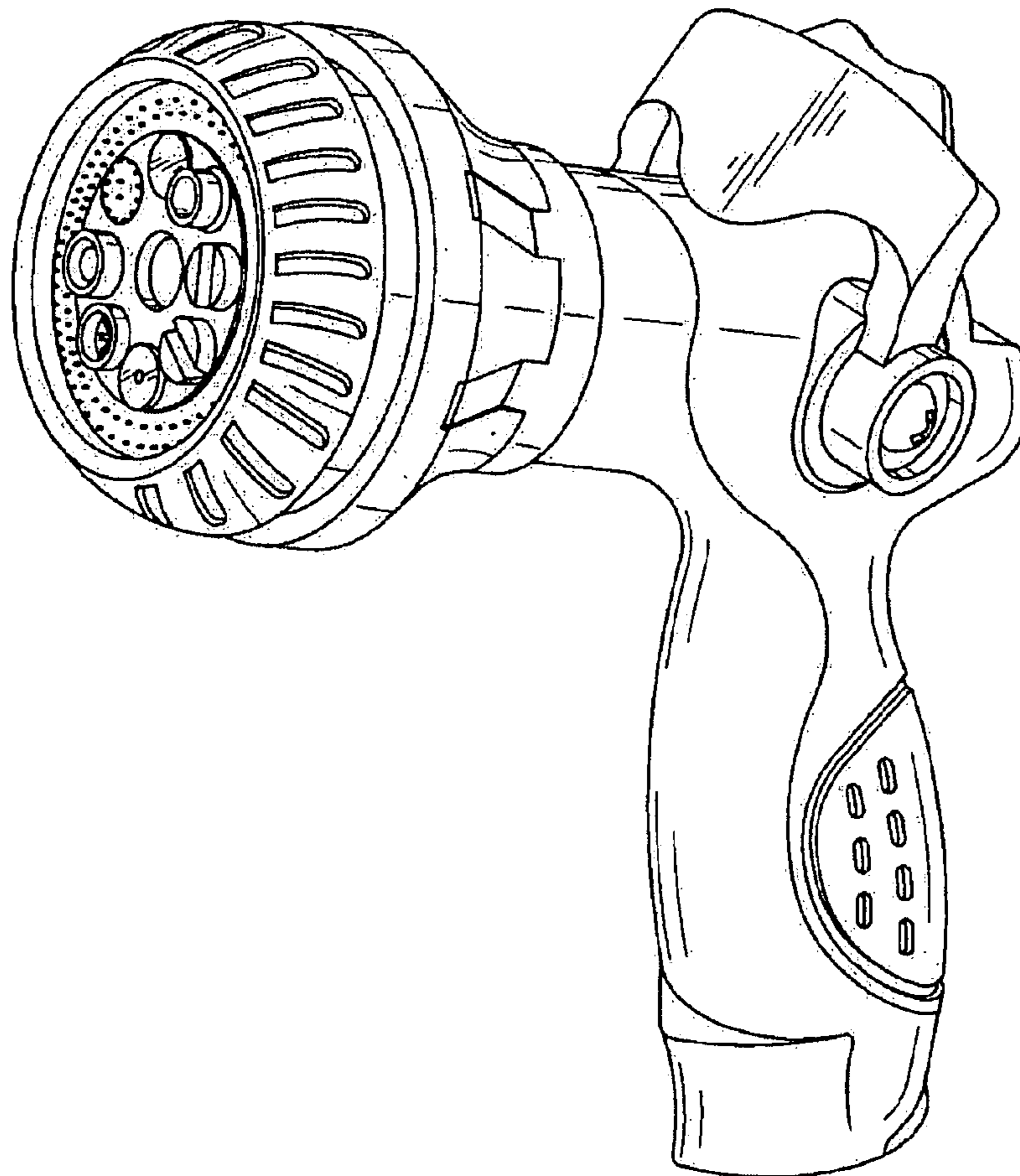

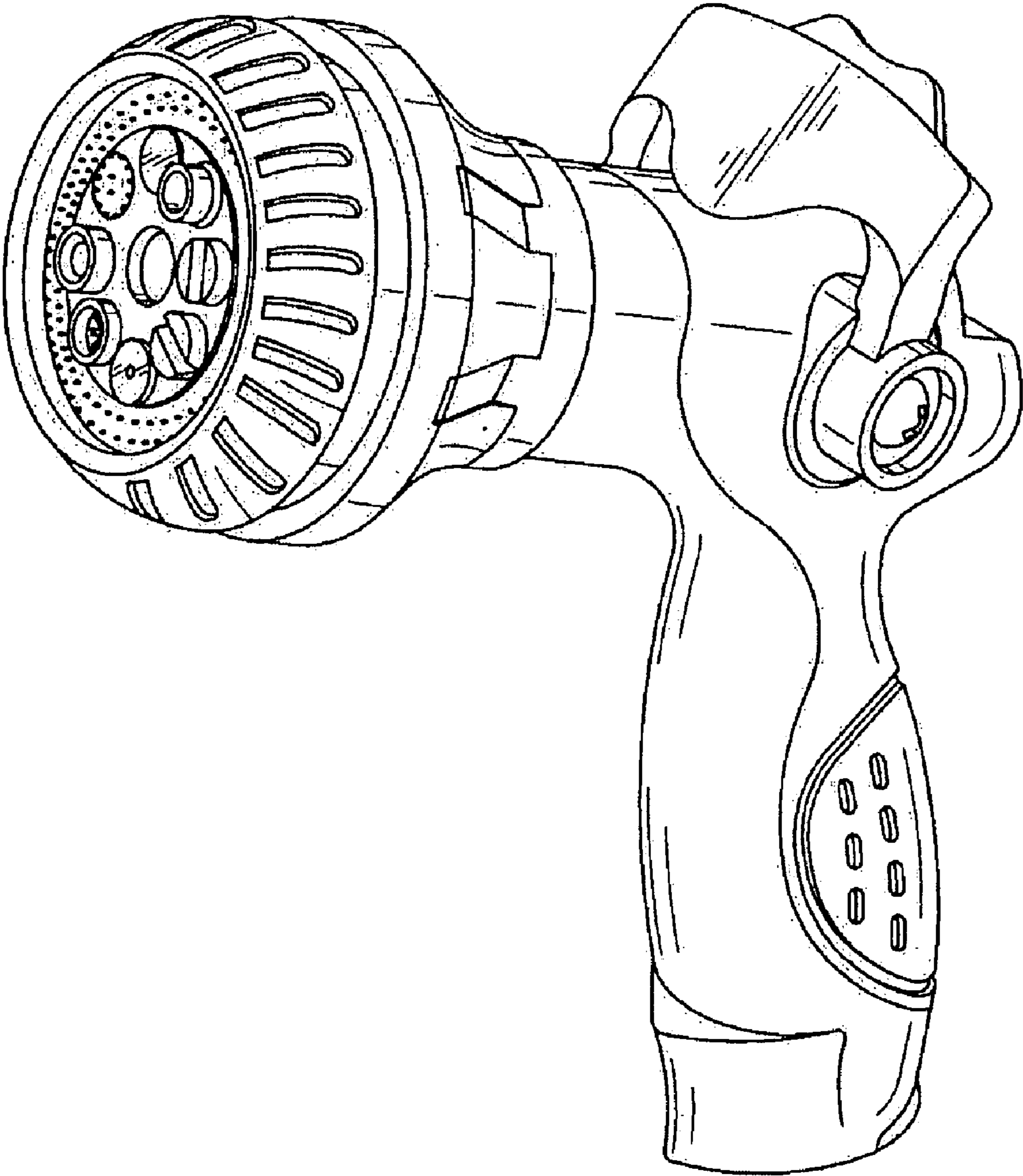

FIG. 1

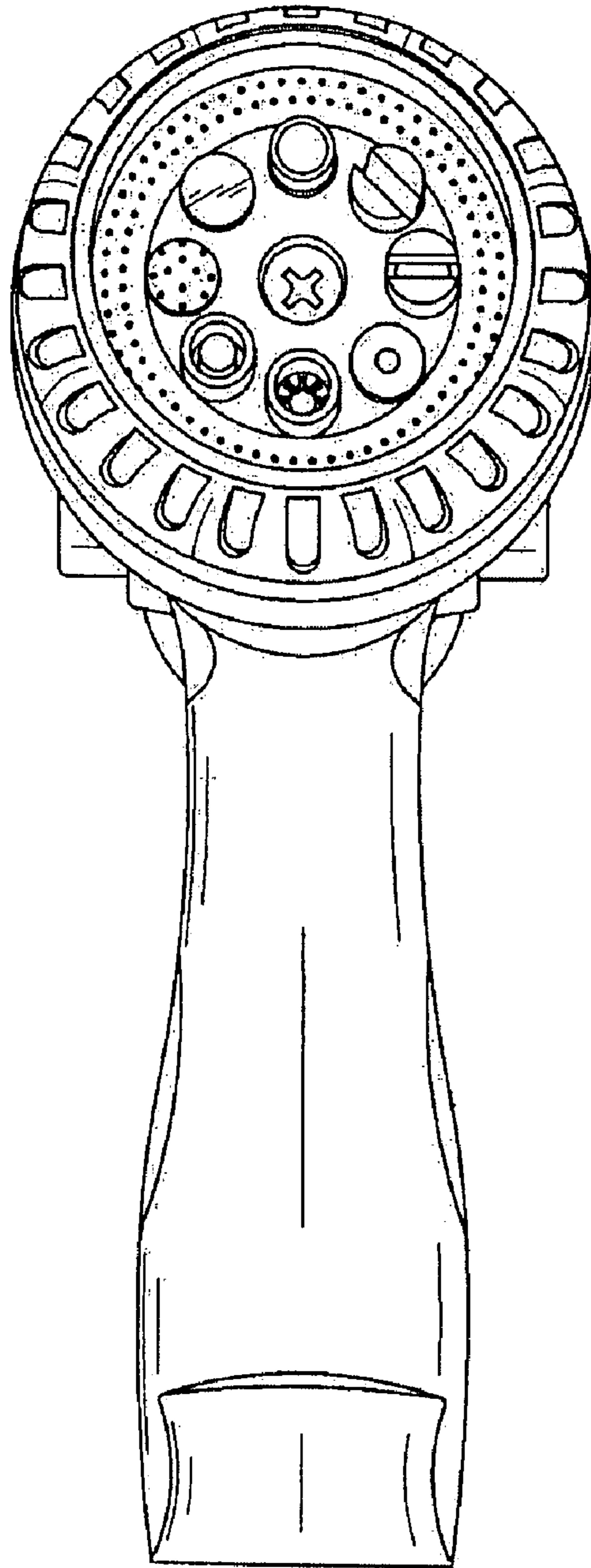

FIG. 2

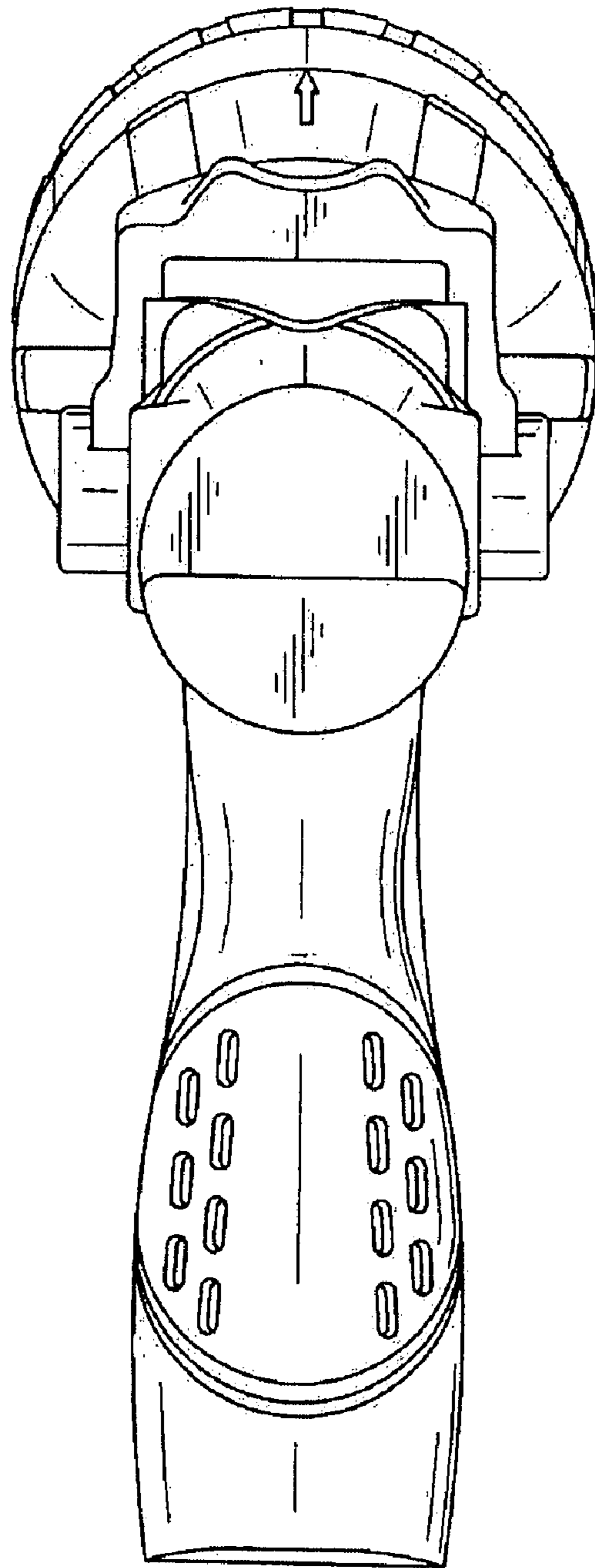

FIG. 3

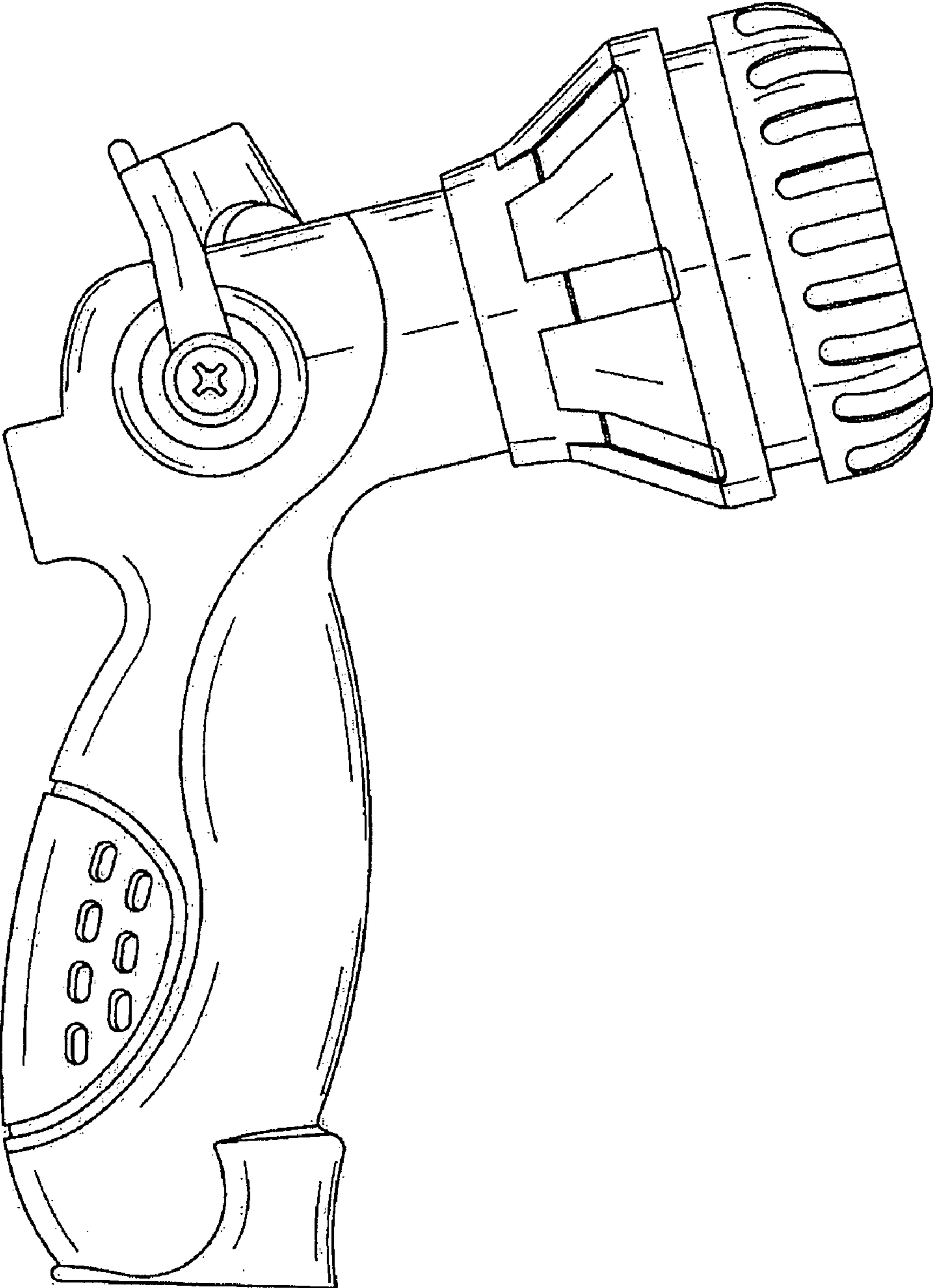

FIG. 4

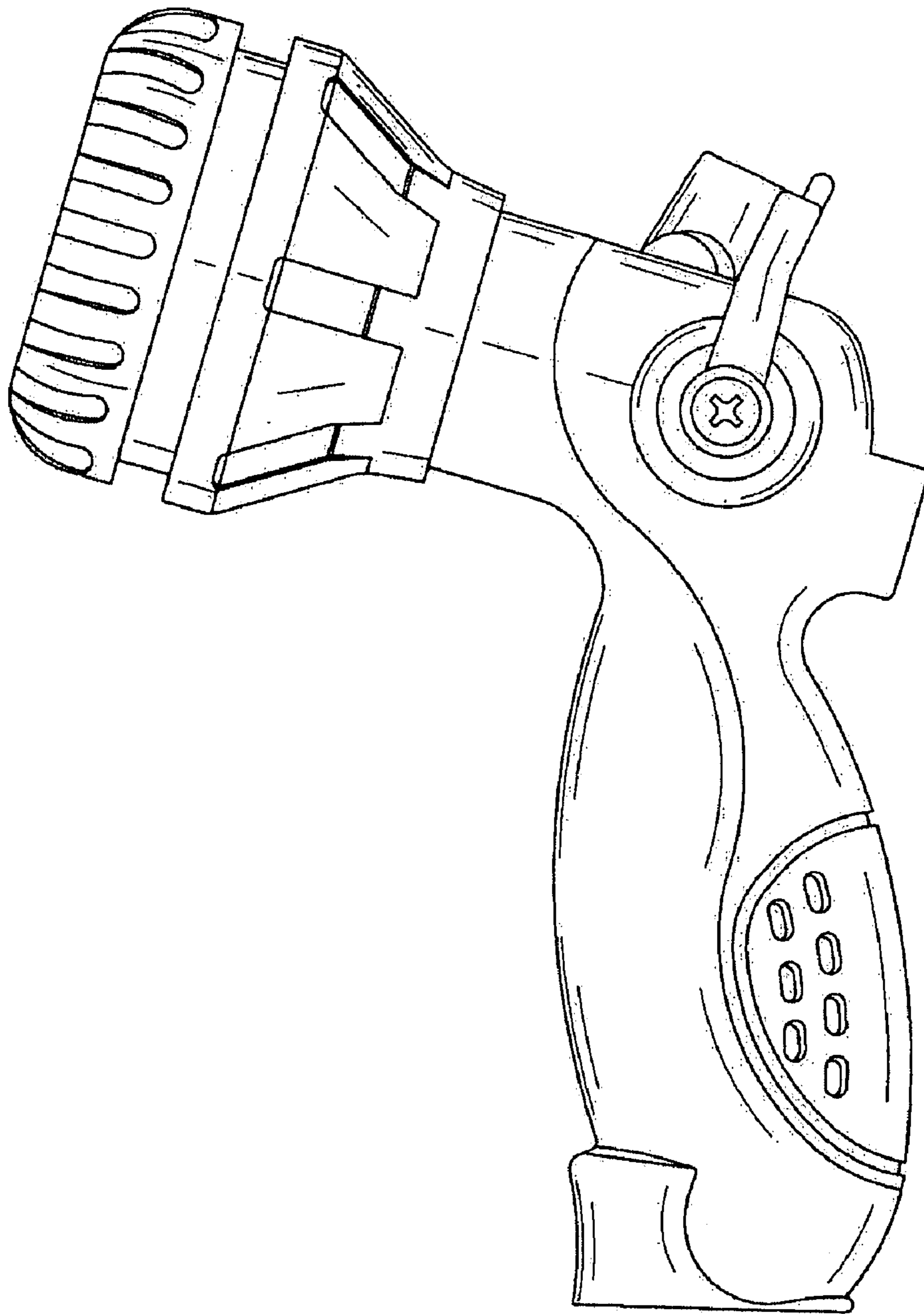

FIG. 5

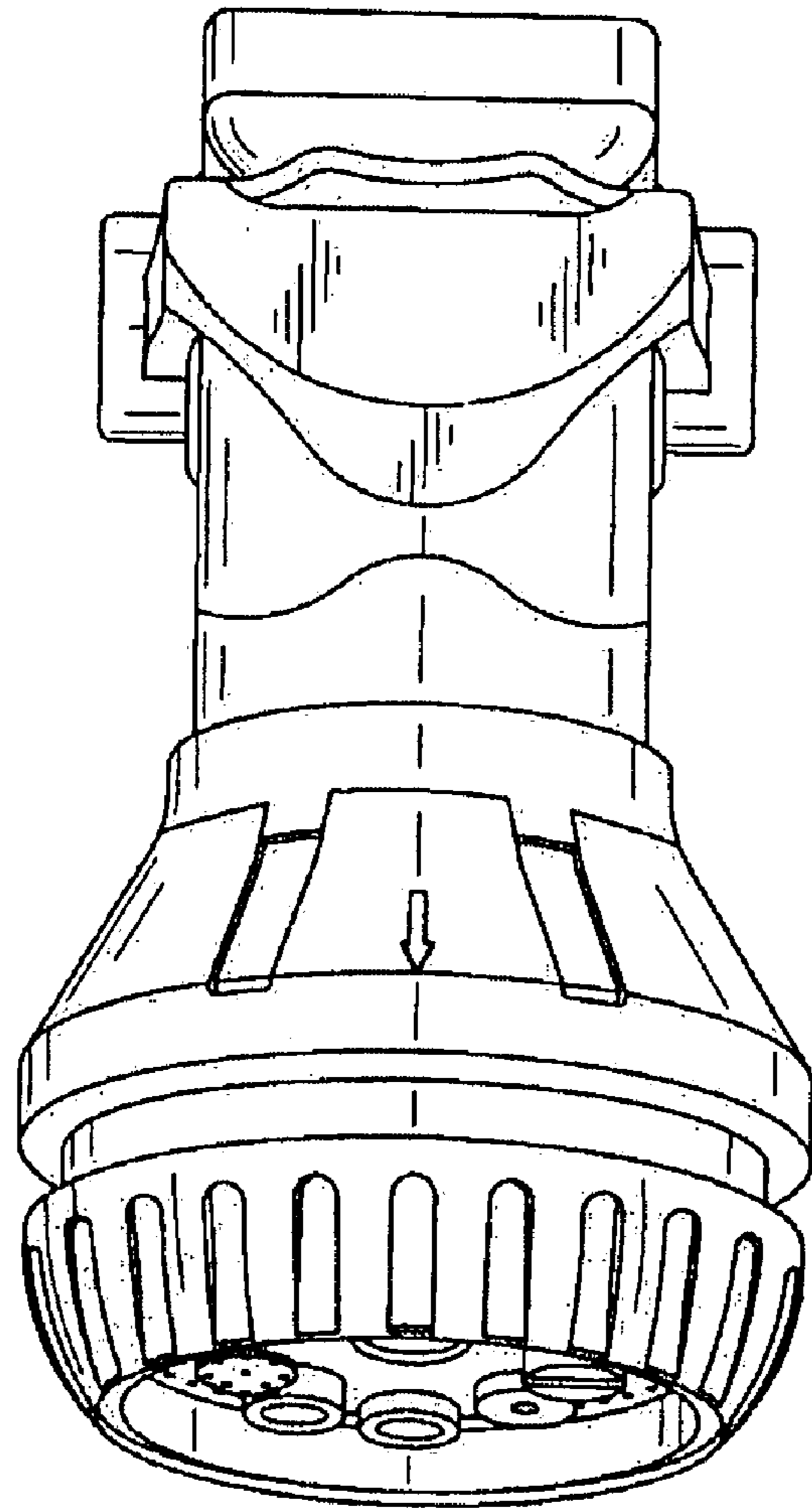

FIG. 6

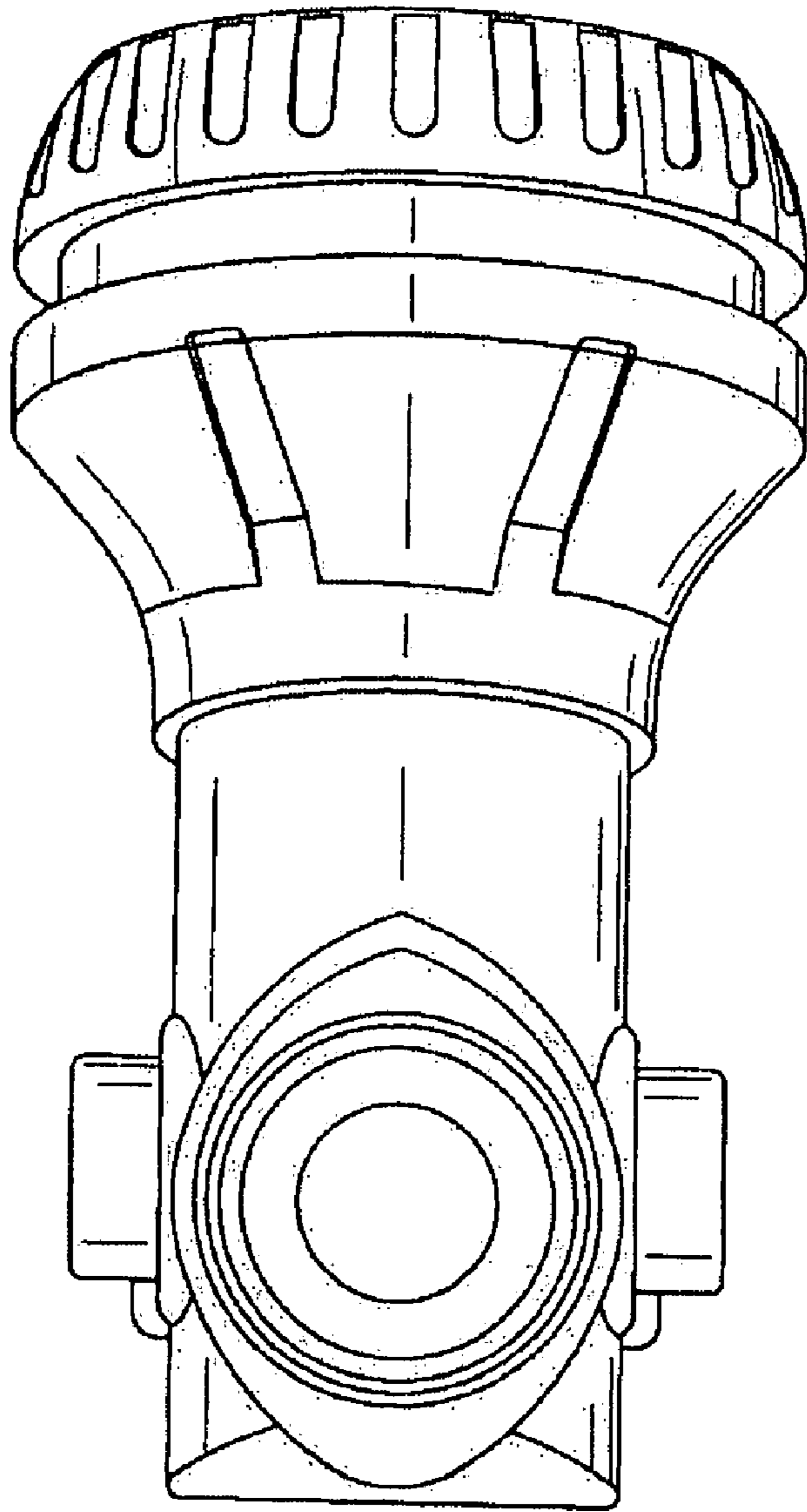

FIG. 7