



US00D572225S

(12) **United States Design Patent**  
**Choi et al.**

(10) **Patent No.:** **US D572,225 S**  
(45) **Date of Patent:** **\*\* Jul. 1, 2008**

(54) **CELLULAR PHONE**

(75) Inventors: **Kwang-Ha Choi**, Seoul (KR);  
**Sang-Min Hyun**, Seoul (KR);  
**Chang-Soo Lee**, Incheon (KR)

(73) Assignee: **Samsung Electronics Co., Ltd.**,  
Suwon-Si (KR)

(\*\*) Term: **14 Years**

(21) Appl. No.: **29/267,704**

(22) Filed: **Oct. 20, 2006**

(30) **Foreign Application Priority Data**

Jun. 5, 2006 (KR) ..... 30-2006-0020866

(51) **LOC (8) Cl.** ..... **14-03**

(52) **U.S. Cl.** ..... **D14/138**

(58) **Field of Classification Search** ..... D14/138,  
D14/496, 341-347; 455/575.3, 575.1; D21/517  
See application file for complete search history.

(56) **References Cited**

**U.S. PATENT DOCUMENTS**

|              |        |             |       |         |
|--------------|--------|-------------|-------|---------|
| D500,480 S * | 1/2005 | Daw         | ..... | D14/138 |
| D501,658 S * | 2/2005 | Park et al. | ..... | D14/138 |
| D502,161 S * | 2/2005 | Kim et al.  | ..... | D14/138 |
| D507,787 S * | 7/2005 | Ahn et al.  | ..... | D14/138 |
| D508,034 S * | 8/2005 | Liao        | ..... | D14/138 |

(Continued)

**OTHER PUBLICATIONS**

Samsung T439 telephone, announced Nov. 2007, [online], [site visited Feb. 14, 2008]. Available from Internet ,<URL: <http://www.gsmaarena.com>>.\*

Samsung E480 telephone, announced Nov. 2006, [online], [site visited Feb. 14, 2008]. Available from Internet ,<URL: <http://www.gsmaarena.com>>.\*

Motorola A910 telephone, announced Jul. 2005, [online], [site visited Feb. 14, 2008]. Available from Internet ,<URL: <http://www.gsmaarena.com>>.\*

LG Trax CU575 telephone, announced Aug. 2007, [online], [site visited Feb. 14, 2008]. Available from Internet ,<URL: <http://www.gsmaarena.com>>.\*

LG U8550 telephone, announced Feb. 2006, [online], [site visited Feb. 14, 2008]. Available from Internet ,<URL: <http://www.gsmaarena.com>>.\*

*Primary Examiner*—Jeffrey D Asch

(74) *Attorney, Agent, or Firm*—Staas & Halsey LLP

(57) **CLAIM**

The ornamental design for a cellular phone, as shown and described.

**DESCRIPTION**

FIG. 1 is a perspective view of a cellular phone according to our new design;

FIG. 2 is a front elevational view thereof;

FIG. 3 is a rear elevational view thereof;

FIG. 4 is a left side elevational view thereof;

FIG. 5 is a right side elevational view thereof;

FIG. 6 is a top plan view thereof;

FIG. 7 is a bottom plan view thereof; and,

FIG. 8 is a front elevational view of the cellular phone according to our new design in a state in which the folder of the cellular phone is opened to be used.

The surface(s) or portion(s) of the article not shown in the drawing or described in the specification form(s) no part of the claimed design.

**1 Claim, 8 Drawing Sheets**

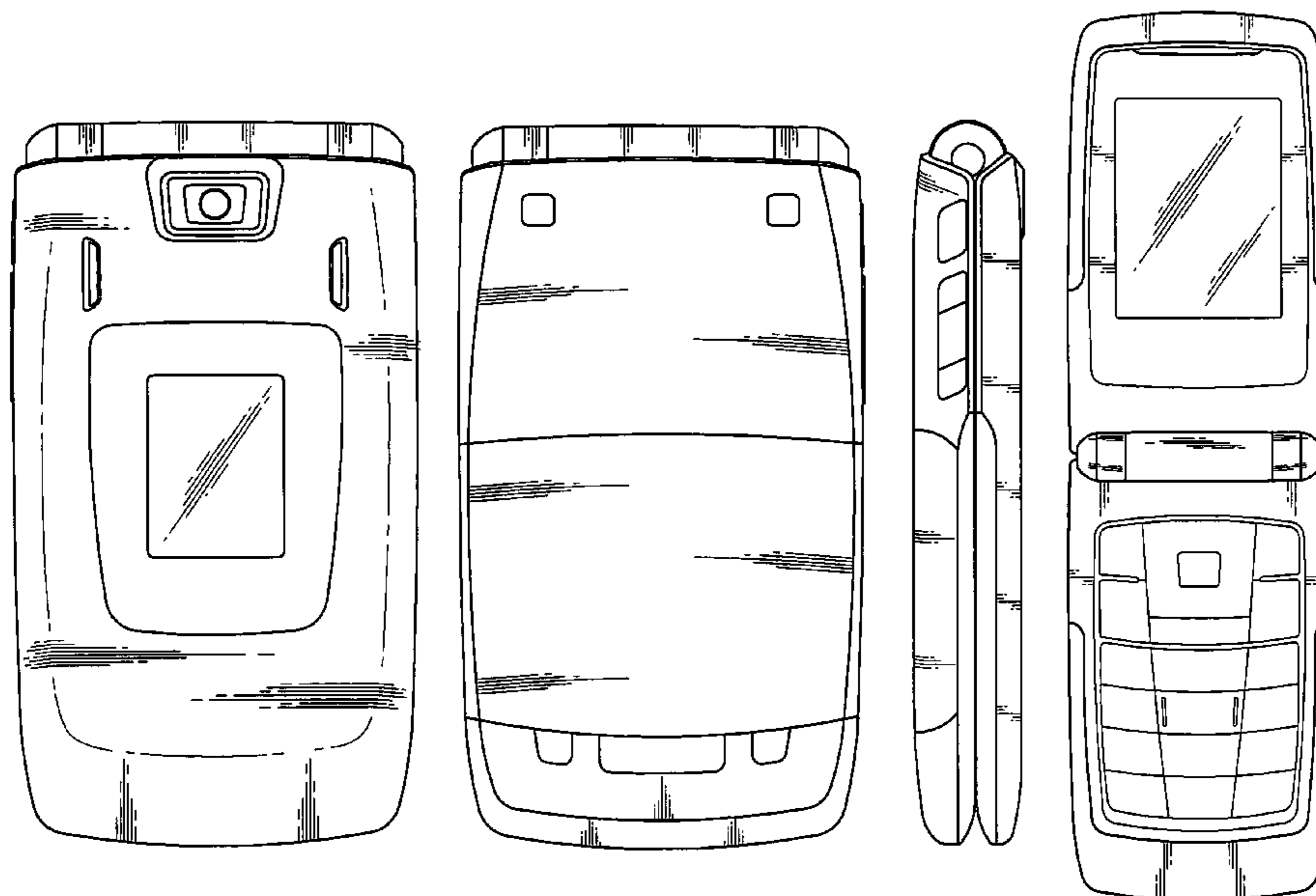

# US D572,225 S

Page 2

---

## U.S. PATENT DOCUMENTS

|              |         |             |       |         |                   |         |                |       |           |
|--------------|---------|-------------|-------|---------|-------------------|---------|----------------|-------|-----------|
| D512,038 S * | 11/2005 | Kim et al.  | ..... | D14/138 | D546,311 S *      | 7/2007  | Lee            | ..... | D14/138   |
| D512,975 S * | 12/2005 | Tsai et al. | ..... | D14/138 | D549,199 S *      | 8/2007  | Sugiura        | ..... | D14/138   |
| D518,463 S * | 4/2006  | Tan et al.  | ..... | D14/138 | D552,065 S *      | 10/2007 | Kim et al.     | ..... | D14/138   |
| D519,098 S * | 4/2006  | Han et al.  | ..... | D14/138 | D554,094 S *      | 10/2007 | Ribeiro et al. | ..... | D14/138   |
| D519,970 S * | 5/2006  | Kang et al. | ..... | D14/138 | D555,129 S *      | 11/2007 | Han et al.     | ..... | D14/138   |
| D525,230 S * | 7/2006  | Kim et al.  | ..... | D14/138 | D557,230 S *      | 12/2007 | Kim et al.     | ..... | D14/138   |
| D537,059 S * | 2/2007  | Hwang       | ..... | D14/138 | D558,169 S *      | 12/2007 | Chung et al.   | ..... | D14/138   |
| D539,772 S * | 4/2007  | Park et al. | ..... | D14/138 | D560,189 S *      | 1/2008  | Kim et al.     | ..... | D14/138   |
| D543,172 S * | 5/2007  | Lee et al.  | ..... | D14/138 | D561,150 S *      | 2/2008  | Kim et al.     | ..... | D14/138   |
| D543,965 S * | 6/2007  | Lee et al.  | ..... | D14/138 | D561,718 S *      | 2/2008  | Kim et al.     | ..... | D14/138   |
|              |         |             |       |         | 2006/0111163 A1 * | 5/2006  | Oh             | ..... | 455/575.7 |

\* cited by examiner

FIG. 1

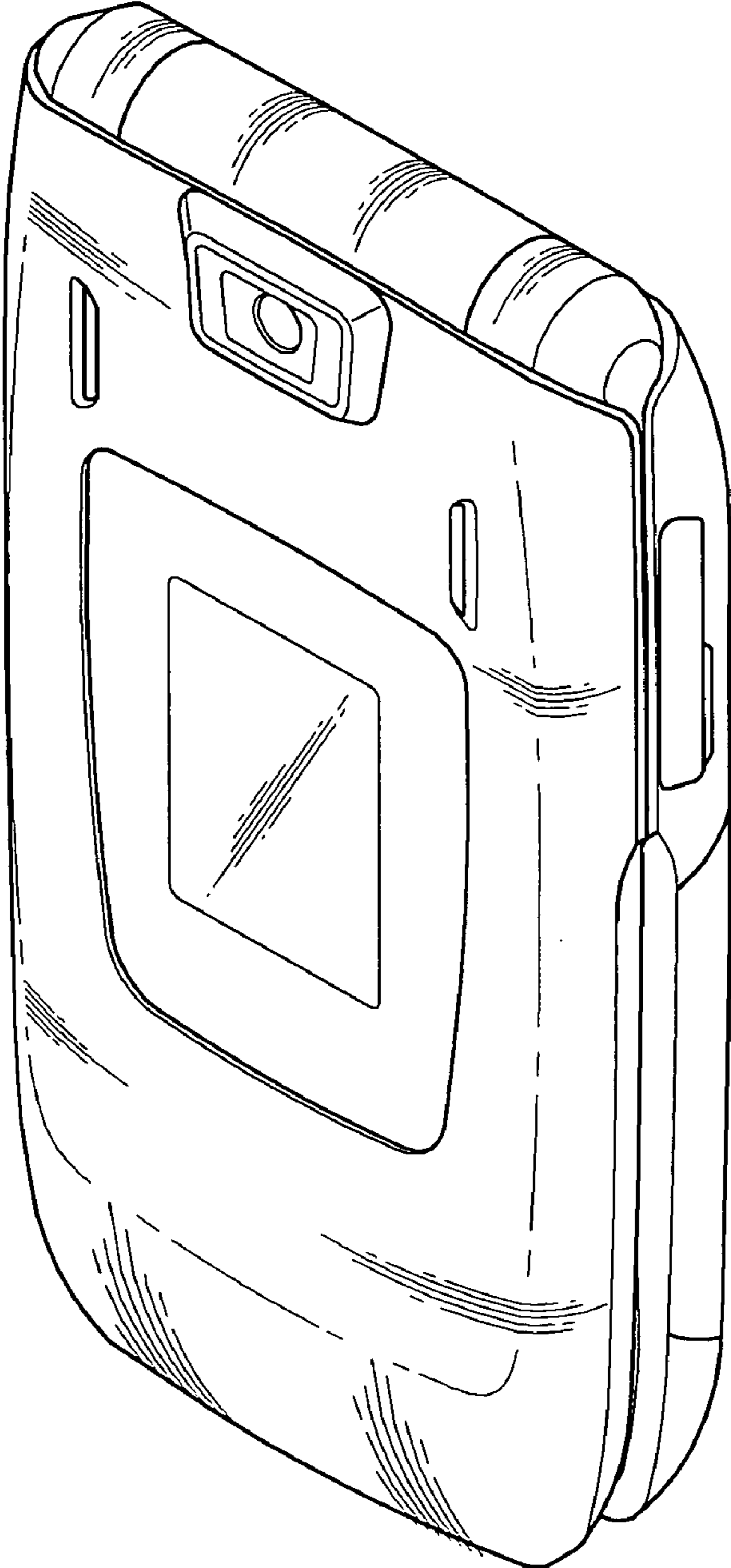

FIG.2

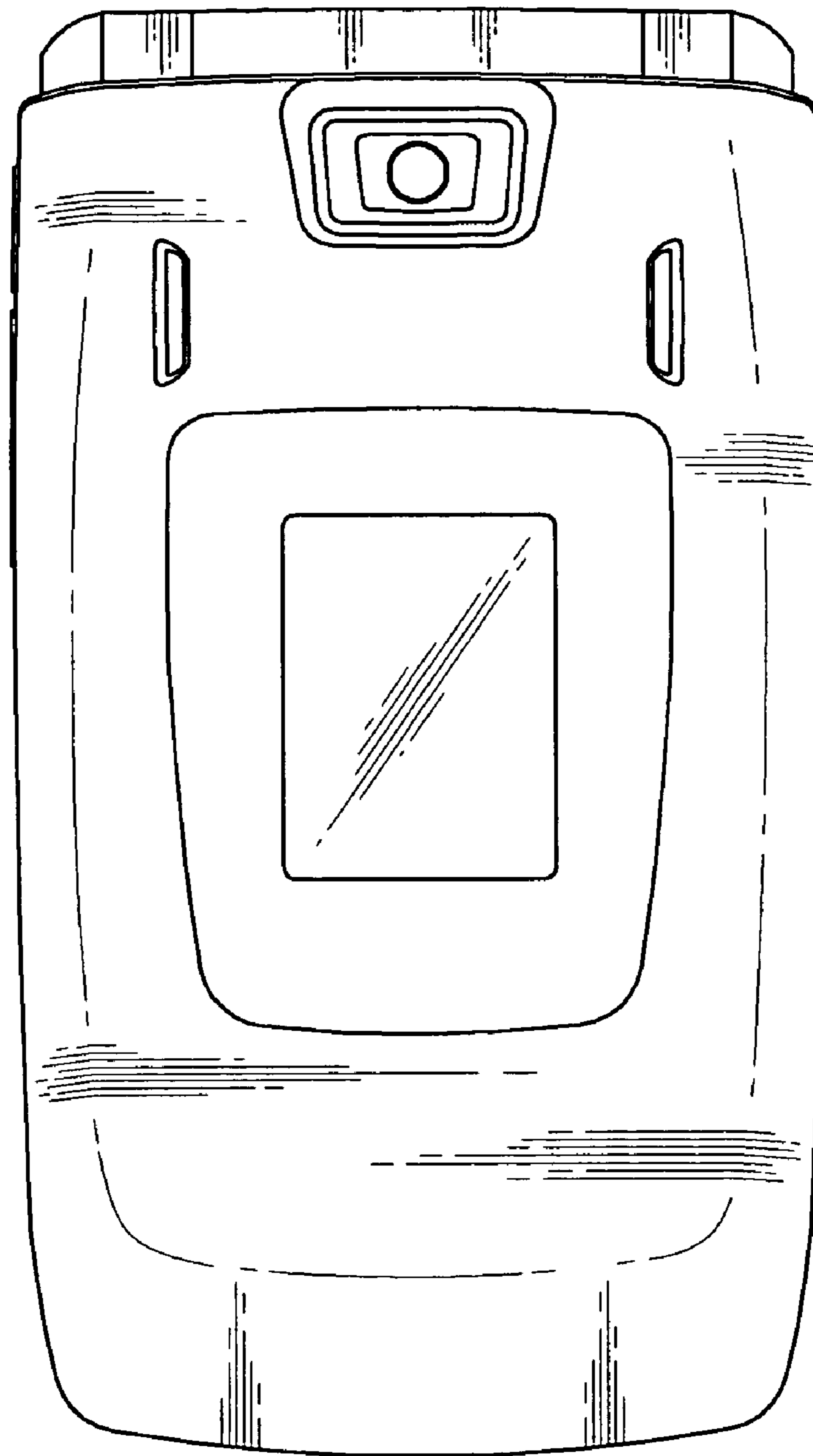

FIG.3

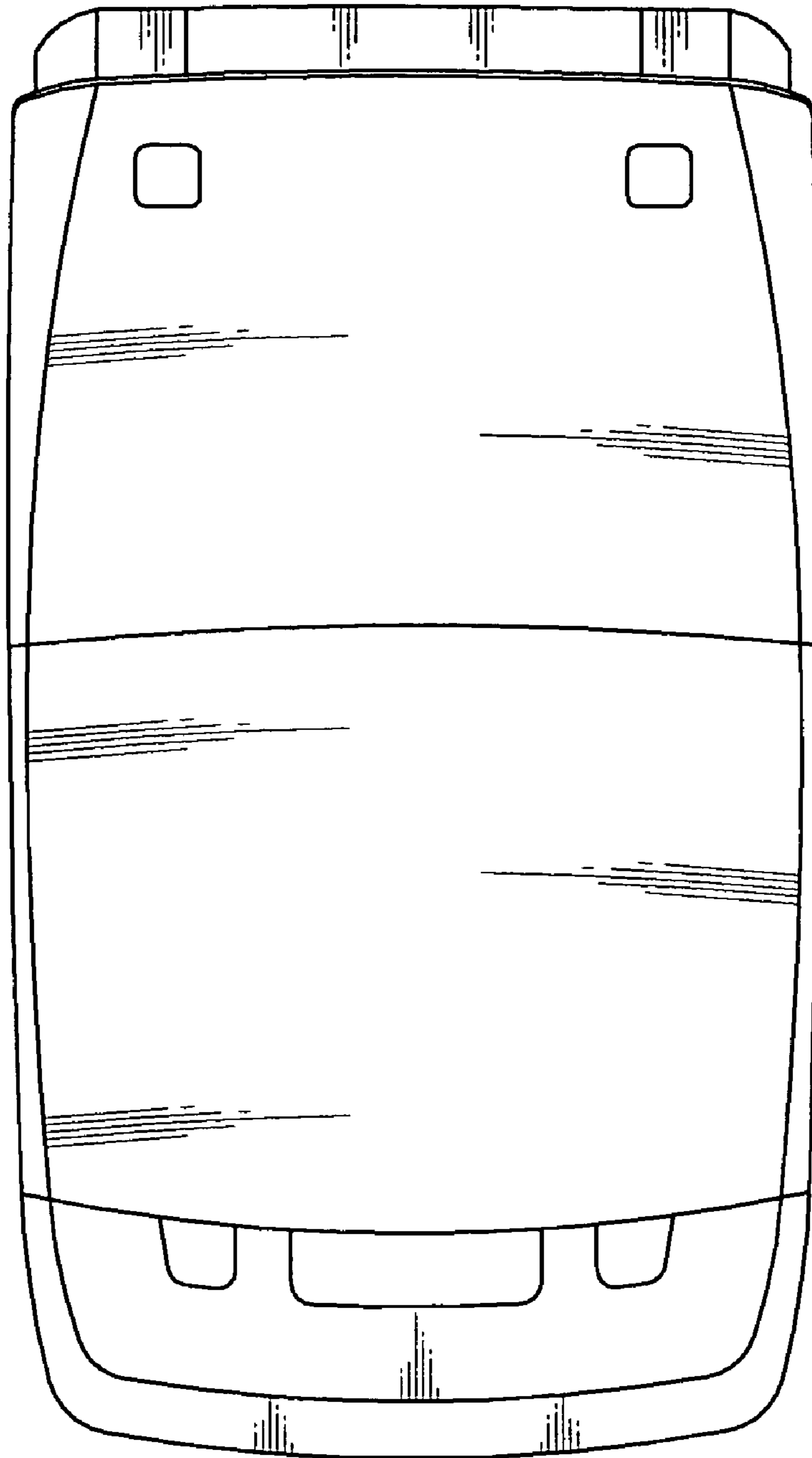

FIG.4

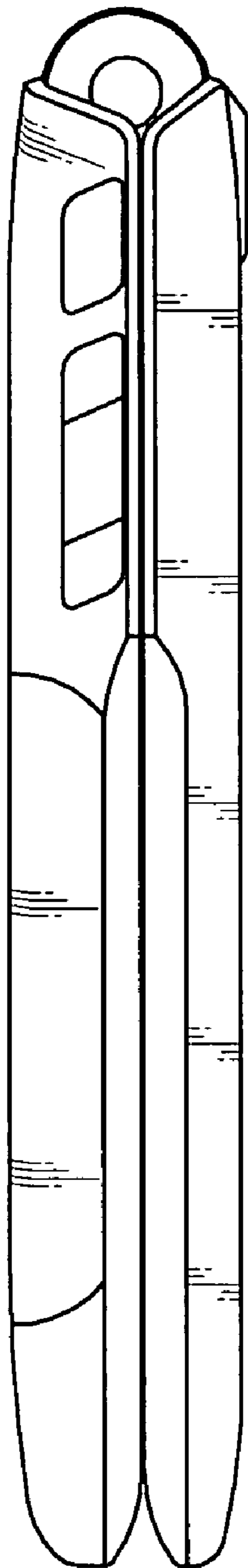

FIG.5

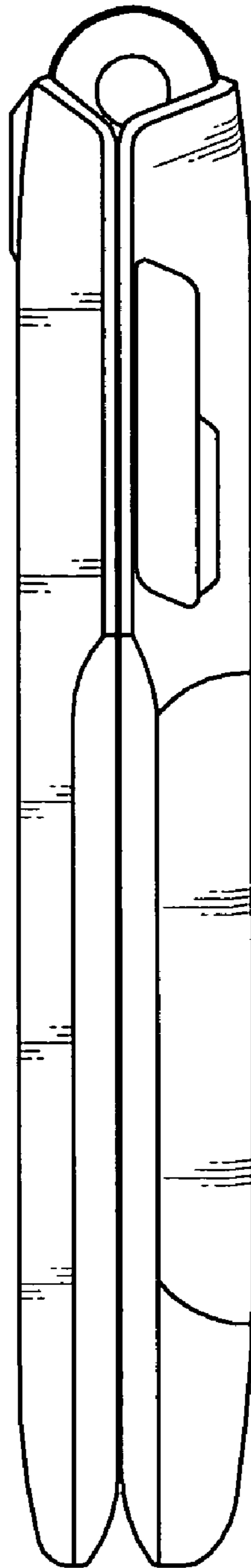

FIG.6

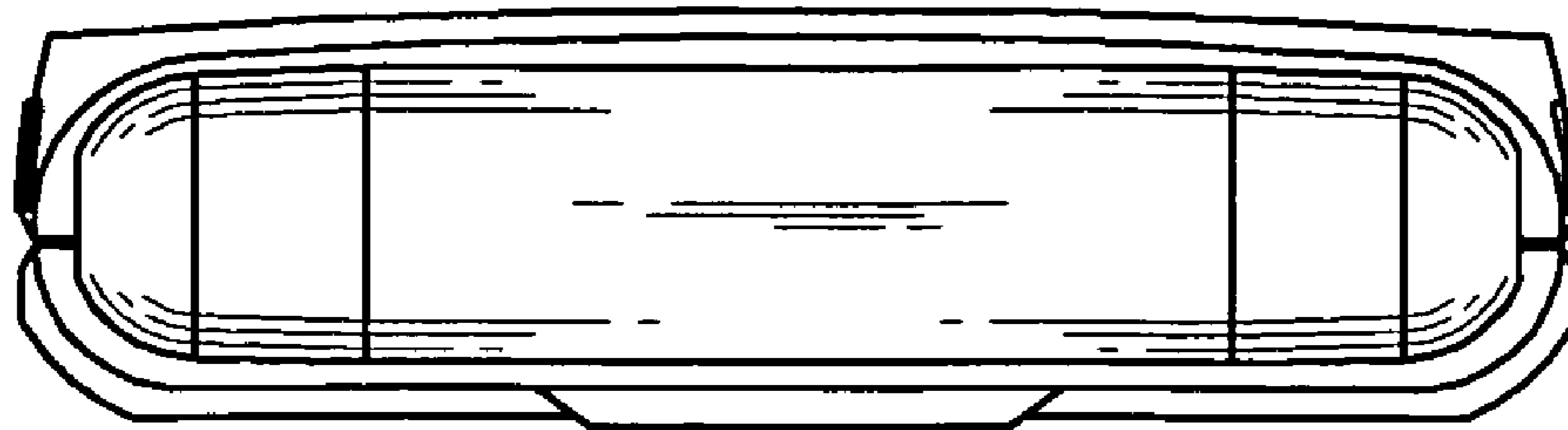



FIG. 7

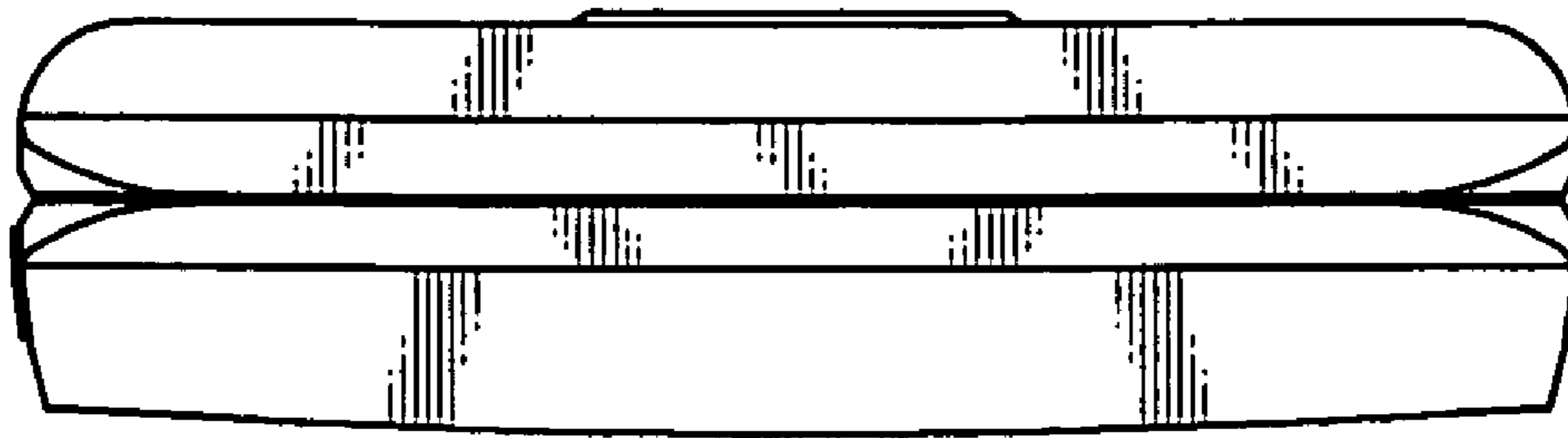

FIG. 8

