



US00D572224S

(12) **United States Design Patent**  
**Kim et al.**

(10) **Patent No.:** **US D572,224 S**  
(45) **Date of Patent:** **\*\* Jul. 1, 2008**

(54) **CELLULAR PHONE**

(75) Inventors: **Sung-Kwon Kim**, Gwangmyeong-si (KR); **Sang-Min Hyun**, Seoul (KR); **Chang-Soo Lee**, Incheon (KR)

(73) Assignee: **Samsung Electronics Co., Ltd.**, Suwon-Si (KR)

(\*\*) Term: **14 Years**

(21) Appl. No.: **29/267,016**

(22) Filed: **Oct. 4, 2006**

(51) **LOC (8) Cl.** ..... **14-03**

(52) **U.S. Cl.** ..... **D14/138**

(58) **Field of Classification Search** ..... D14/138,  
D14/496, 341-347; 455/575.3, 575.1; D21/517  
See application file for complete search history.

(56) **References Cited**

**U.S. PATENT DOCUMENTS**

D432,535 S *	10/2000	Loh et al.	.....	D14/345
D500,481 S *	1/2005	Kim et al.	.....	D14/138
D501,657 S *	2/2005	Kim	.....	D14/138
D507,552 S *	7/2005	Liang	.....	D14/138
D513,742 S *	1/2006	Arnholt et al.	.....	D14/138
D515,054 S *	2/2006	Ishiura et al.	.....	D14/138
D519,098 S *	4/2006	Han et al.	.....	D14/138
D541,250 S *	4/2007	Yoo et al.	.....	D14/138
D545,286 S *	6/2007	Lee et al.	.....	D14/138
D547,291 S *	7/2007	Lee	.....	D14/138
D549,199 S *	8/2007	Sugiura	.....	D14/138
D551,642 S *	9/2007	Kim et al.	.....	D14/138
D552,065 S *	10/2007	Kim et al.	.....	D14/138
D555,124 S *	11/2007	Lee	.....	D14/138
D555,129 S *	11/2007	Han et al.	.....	D14/138

(Continued)

**OTHER PUBLICATIONS**

Samsung T439 telephone, announced Nov. 2007, [online], [site visited Feb. 14, 2008]. Available from Internet ,<URL: http://www.gsmarena.com>.\*

Samsung J400 telephone, announced Jan. 2007, [online], [site visited Feb. 14, 2008]. Available from Internet ,<URL: http://www.gsmarena.com>.\*

Samsung X680 telephone, announced 2<sup>nd</sup> quarter 2006, [online], [site visited Feb. 14, 2008]. Available from Internet ,<URL: http://www.gsmarena.com>.\*

Siemens CF75 telephone, announced 1<sup>st</sup> quarter 2005, [online], [site visited Feb. 14, 2008]. Available from Internet ,<URL: http://www.gsmarena.com>.\*

NEC e636 telephone, announced Feb. 2006, [online], [site visited Feb. 14, 2008]. Available from Internet ,<URL: http://www.gsmarena.com>.\*

*Primary Examiner*—Jeffrey D Asch

(74) *Attorney, Agent, or Firm*—Staas & Halsey LLP

(57) **CLAIM**

The ornamental design for a cellular phone, as shown and described.

**DESCRIPTION**

FIG. 1 is a perspective view of a cellular phone according to our new design;

FIG. 2 is a front elevational view thereof;

FIG. 3 is a rear elevational view thereof;

FIG. 4 is a left side elevational view thereof;

FIG. 5 is a right side elevational view thereof;

FIG. 6 is a top plan view thereof;

FIG. 7 is a bottom plan view thereof;

FIG. 8 is a right side elevational view of the cellular phone according to our new design in a state in which the cellular phone is opened to be used; and,

FIG. 9 is a front elevational view of the cellular phone according to our new design in a state in which the cellular phone is opened to be used.

The surface(s) or portion(s) of the article not shown in the drawing or described in the specification form(s) no part of the claimed design.

**1 Claim, 9 Drawing Sheets**

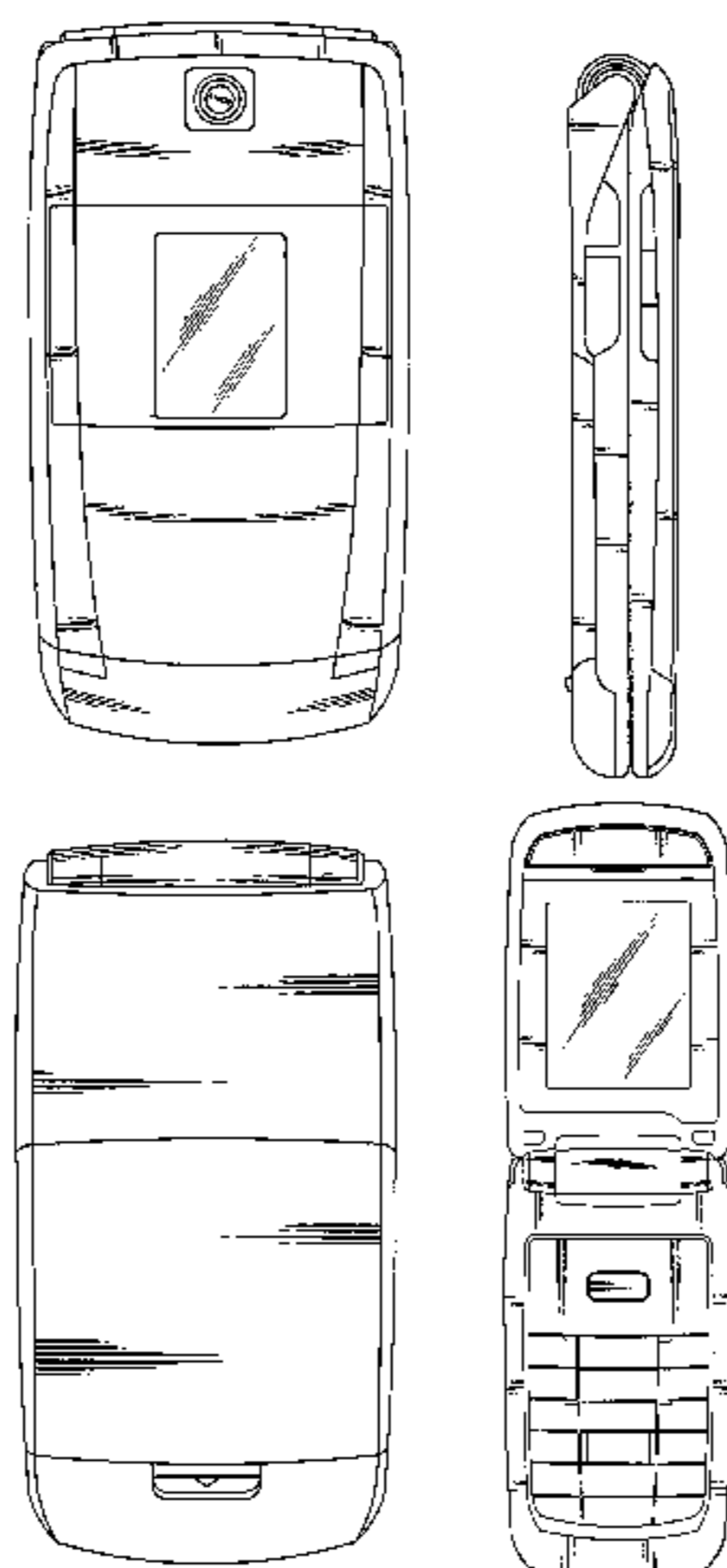

# US D572,224 S

Page 2

---

## U.S. PATENT DOCUMENTS

D558,169 S *	12/2007	Chung et al. ....	D14/138	D560,640 S *	1/2008	Suk et al. ....	D14/138
D560,186 S *	1/2008	Kim et al. ....	D14/138	D560,643 S *	1/2008	Kim et al. ....	D14/138
D560,189 S *	1/2008	Kim et al. ....	D14/138	D561,150 S *	2/2008	Kim et al. ....	D14/138
D560,639 S *	1/2008	Kim et al. ....	D14/138	D561,718 S *	2/2008	Kim et al. ....	D14/138
				2004/0109559 A1 *	6/2004	Lee .....	379/433.04

\* cited by examiner

FIG. 1

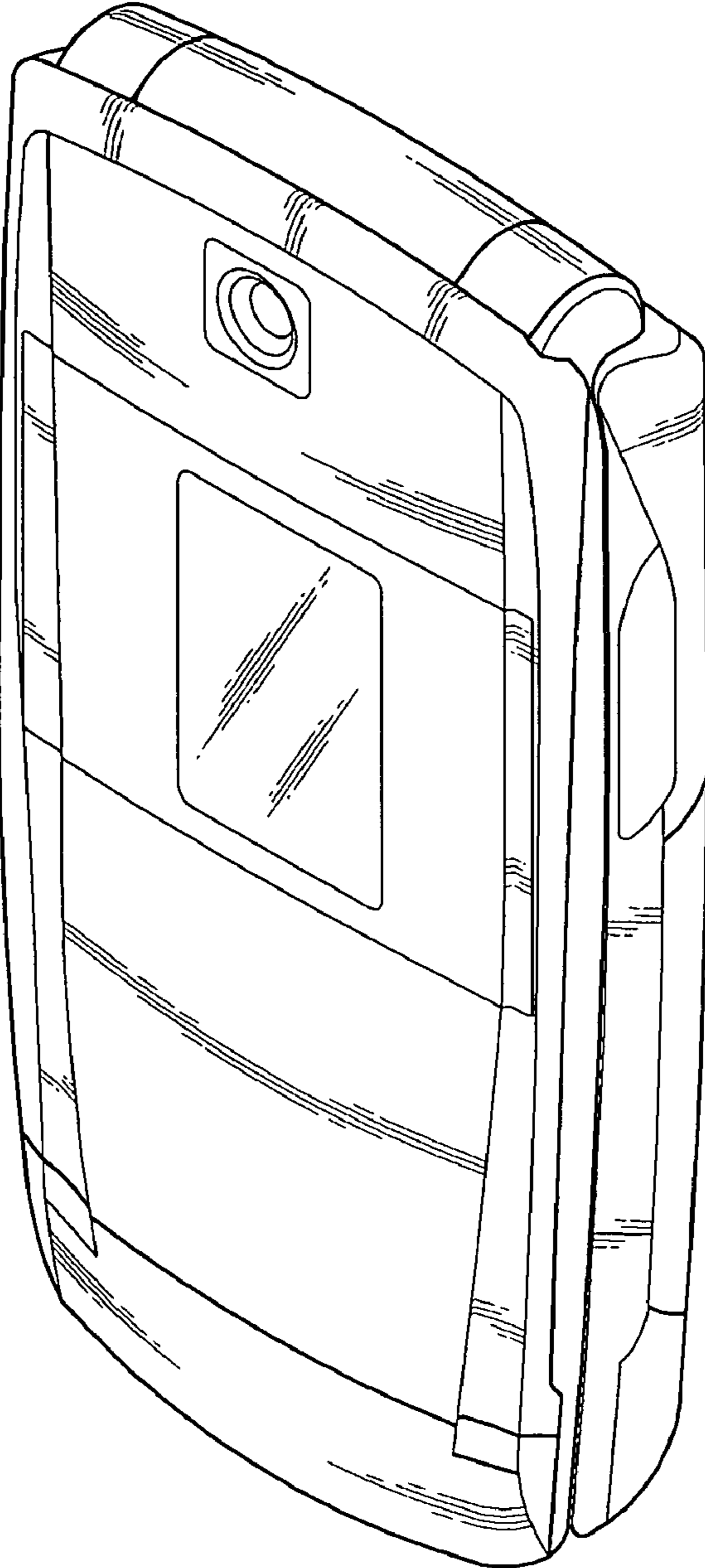

FIG.2

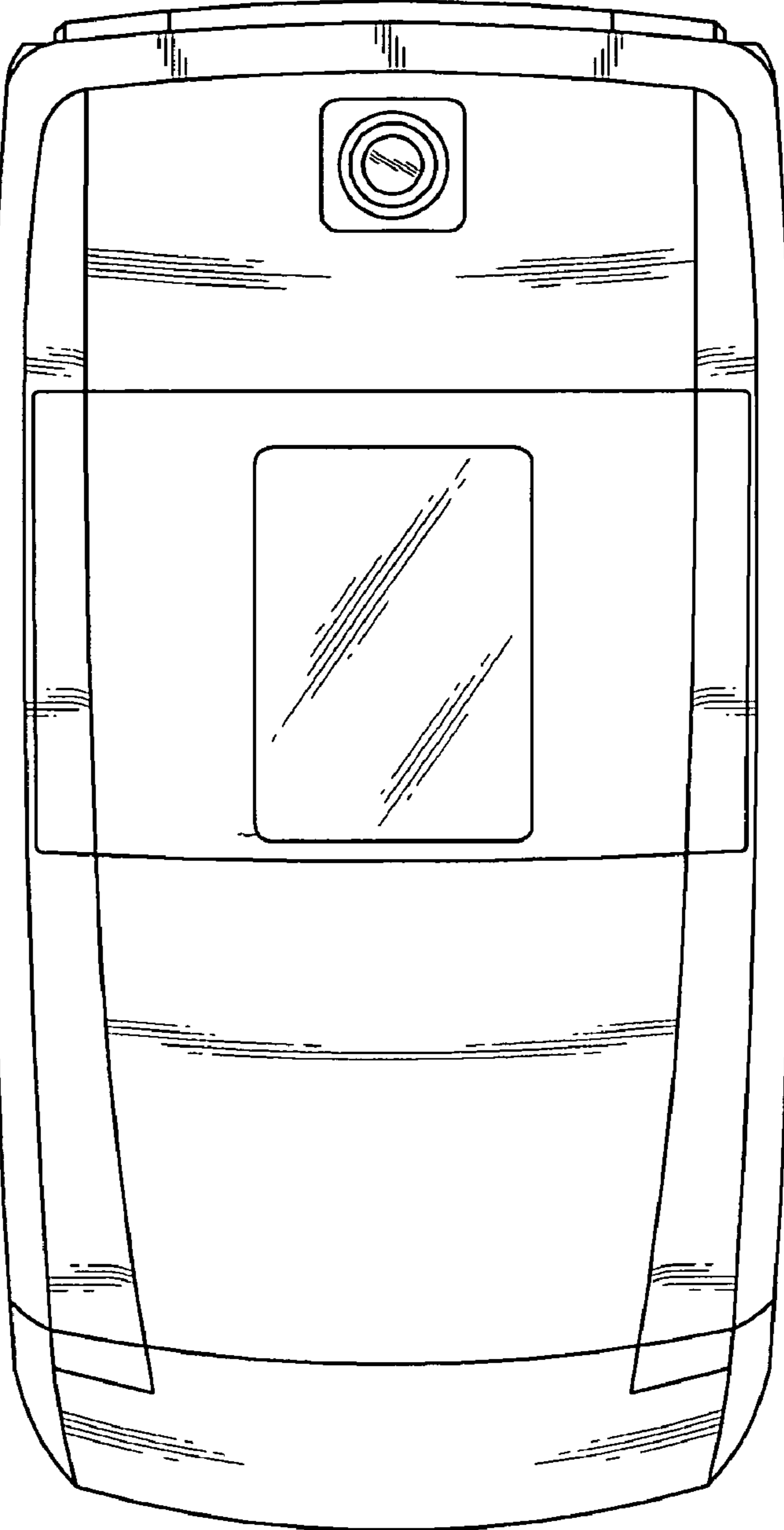

FIG.3

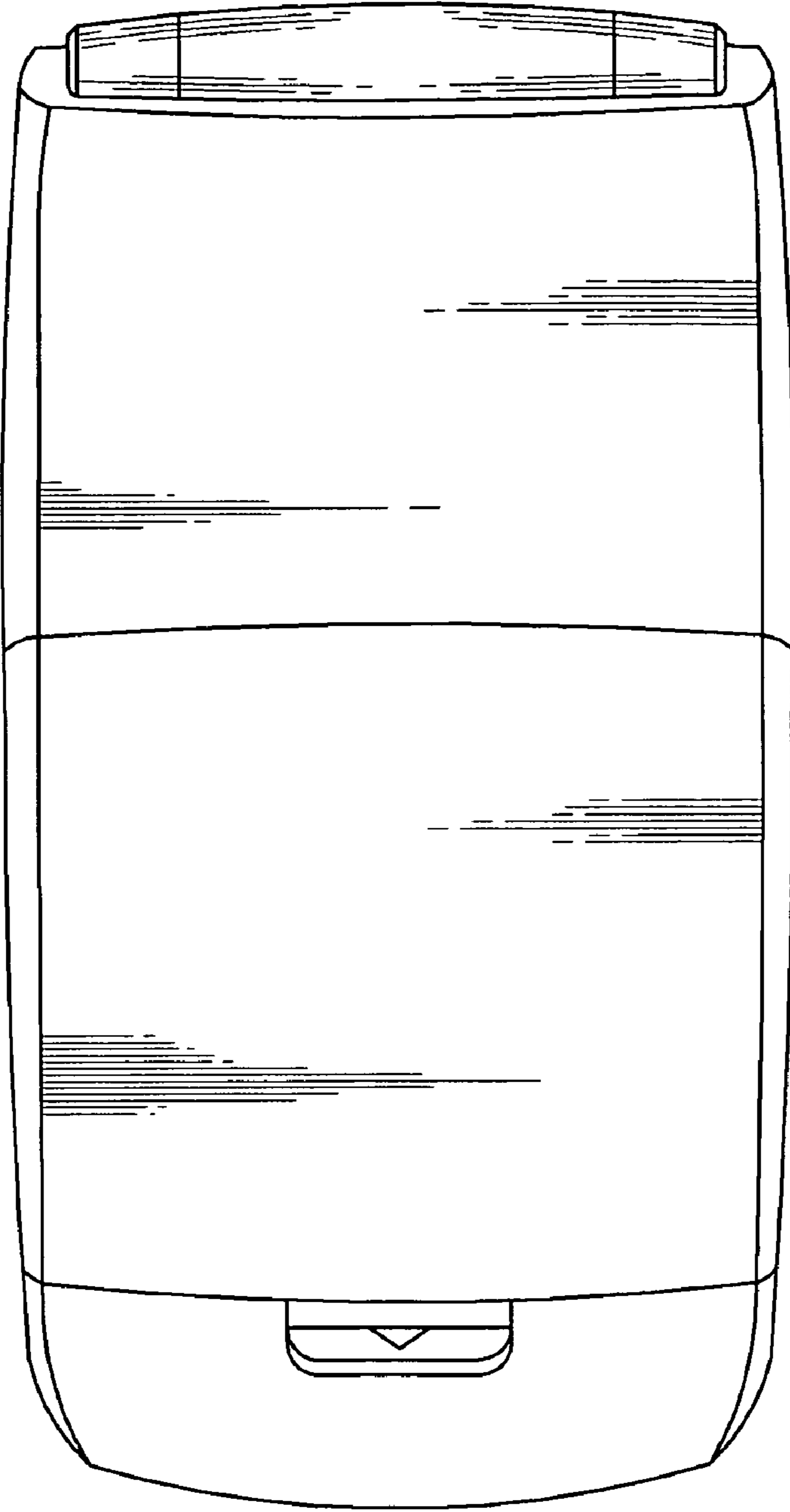

FIG.4

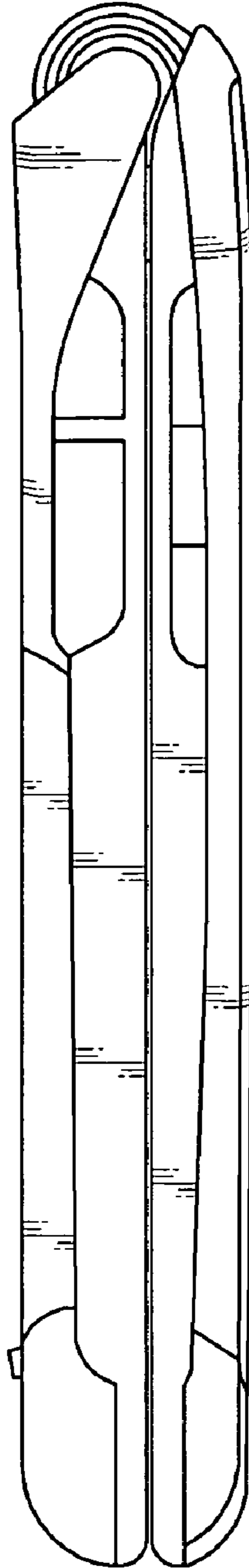

FIG. 5

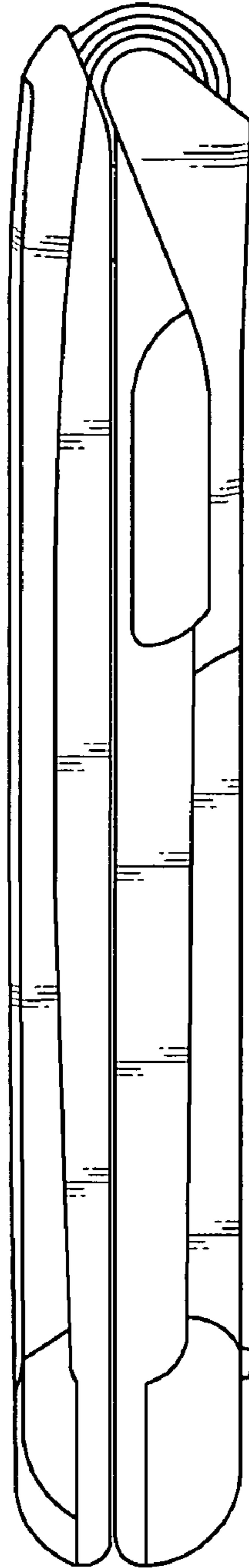

FIG.6





FIG. 7

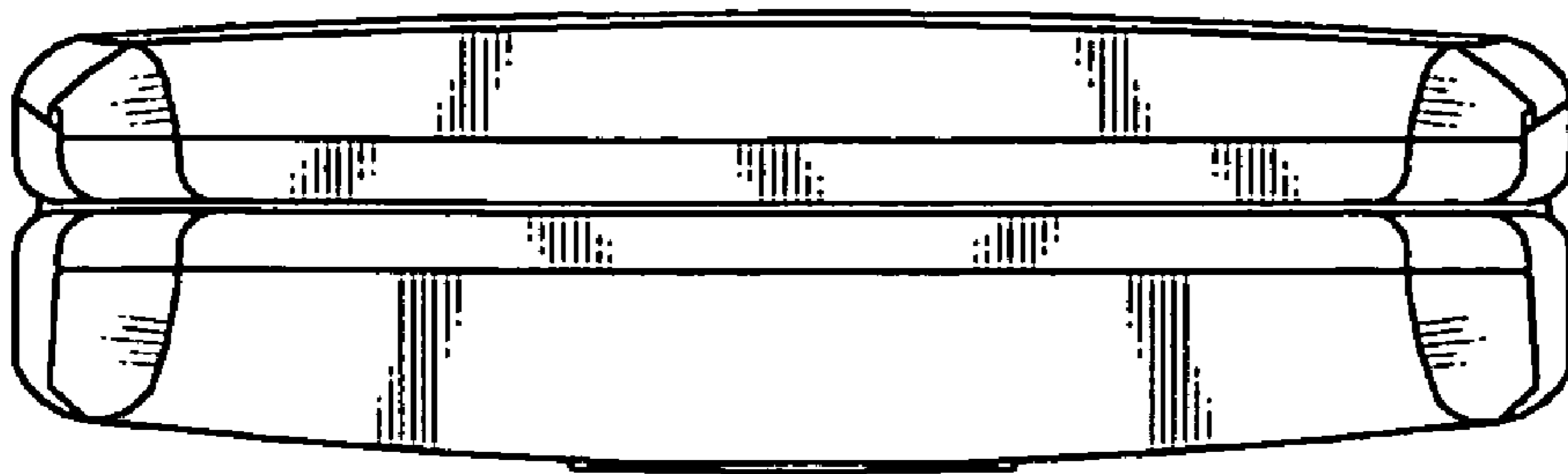

FIG.8

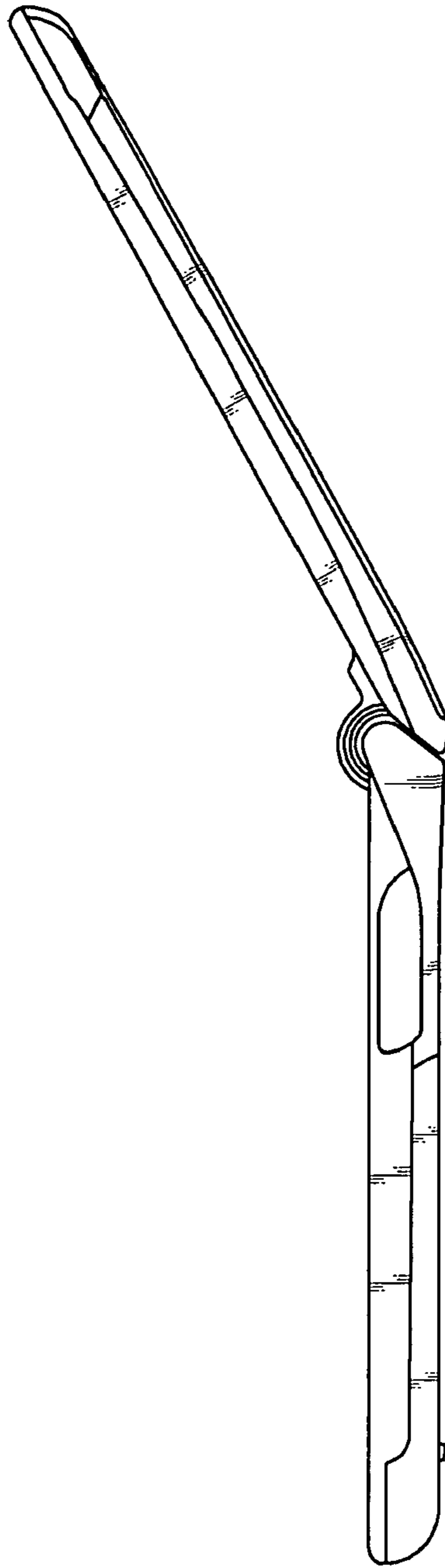

FIG.9

