



US00D572063S

(12) **United States Design Patent**
Provost et al.

(10) **Patent No.:** **US D572,063 S**
(45) **Date of Patent:** **** Jul. 1, 2008**

(54) **RAZOR STAND**

D544,737 S * 6/2007 Nagoya D6/526

(75) Inventors: **Craig Alan Provost**, Boston, MA (US);
Kristopher William Schulz,
Framingham, MA (US)

(73) Assignee: **The Gillette Company**, Boston, MA
(US)

(**) Term: **14 Years**

(21) Appl. No.: **29/286,378**

(22) Filed: **May 3, 2007**

(51) **LOC (8) Cl.** **28-03**

(52) **U.S. Cl.** **D6/526**

(58) **Field of Classification Search** D6/526,
D6/524, 540; 211/13.1, 70.6, 87.01, 89.01;
248/200, 205.5, 309.1, 314, 127, 176.1
See application file for complete search history.

(56) **References Cited**

U.S. PATENT DOCUMENTS

D335,599	S	*	5/1993	Novak	D6/526
5,228,580	A		7/1993	Grange		
D345,269	S	*	3/1994	Novak	D6/526
5,407,066	A		4/1995	Grange		
5,429,241	A		7/1995	Althaus		
D400,746	S	*	11/1998	Althaus et al.	D6/526
D425,255	S	*	5/2000	Chen	D6/526
D531,439	S	*	11/2006	Kling	D6/526

OTHER PUBLICATIONS

Screen Shot from the Art of Shaving Website visited on Mar. 30, 2007
showing "Compact Shaving Set" (1 page of razor stands in color).

* cited by examiner

Primary Examiner—Brian N Vinson

(74) *Attorney, Agent, or Firm*—Kevin C. Johnson

(57) **CLAIM**

The ornamental design for a razor stand, as shown and
described.

DESCRIPTION

FIG. 1 is a top perspective view of a razor stand showing our
new design;

FIG. 2 is a front elevation view thereof;

FIG. 3 is a right side elevation view thereof;

FIG. 4 is a rear elevation view thereof;

FIG. 5 is a left side elevation view thereof;

FIG. 6 is a top plan view thereof;

FIG. 7 is a bottom plan view thereof; and,

FIG. 8 is a perspective view similar to FIG. 1 with the broken
line disclosure of the shaving razor and brush being for illus-
trative purposes only and forming no part of the claimed
design.

1 Claim, 5 Drawing Sheets

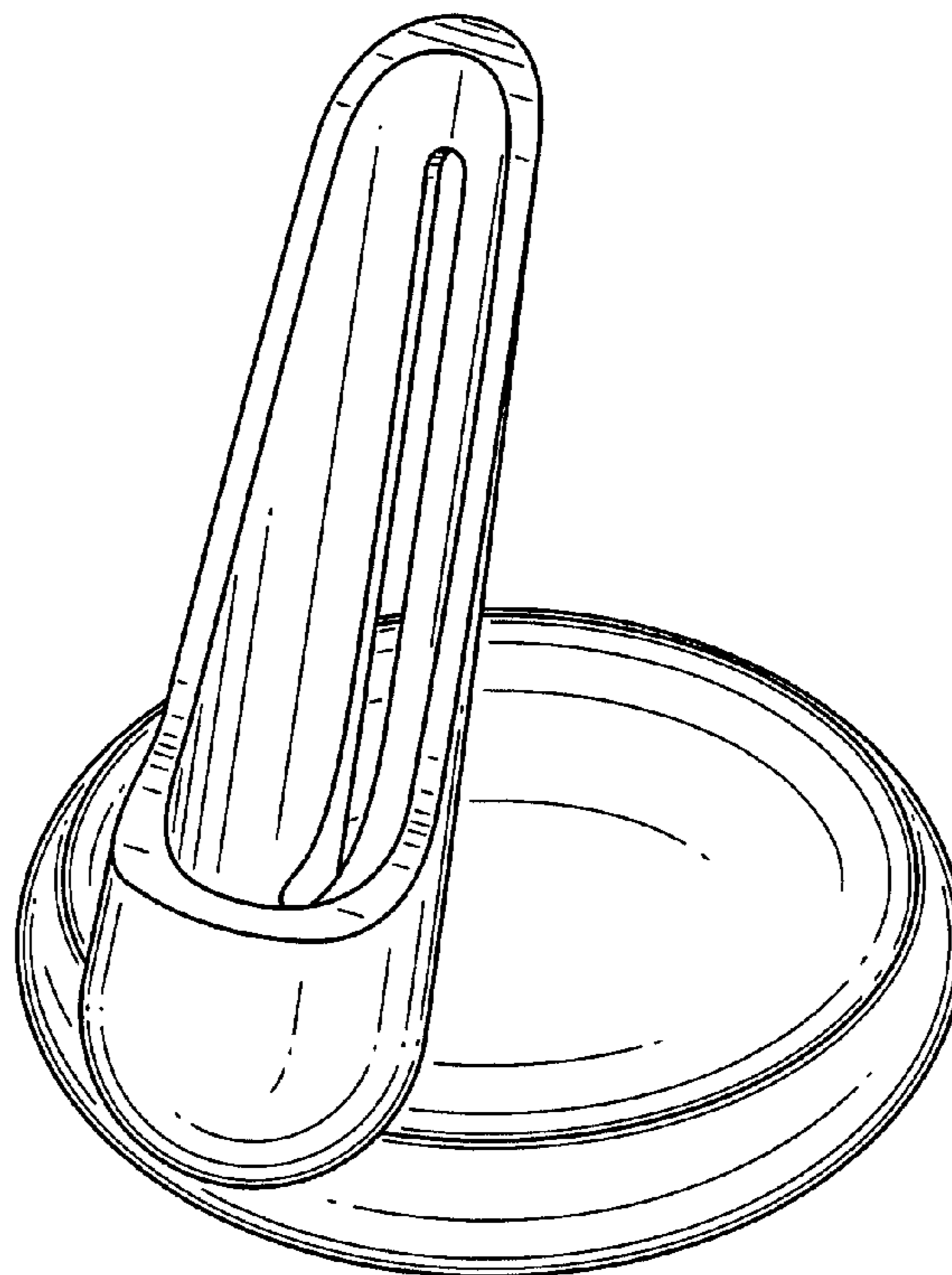

FIG. 1

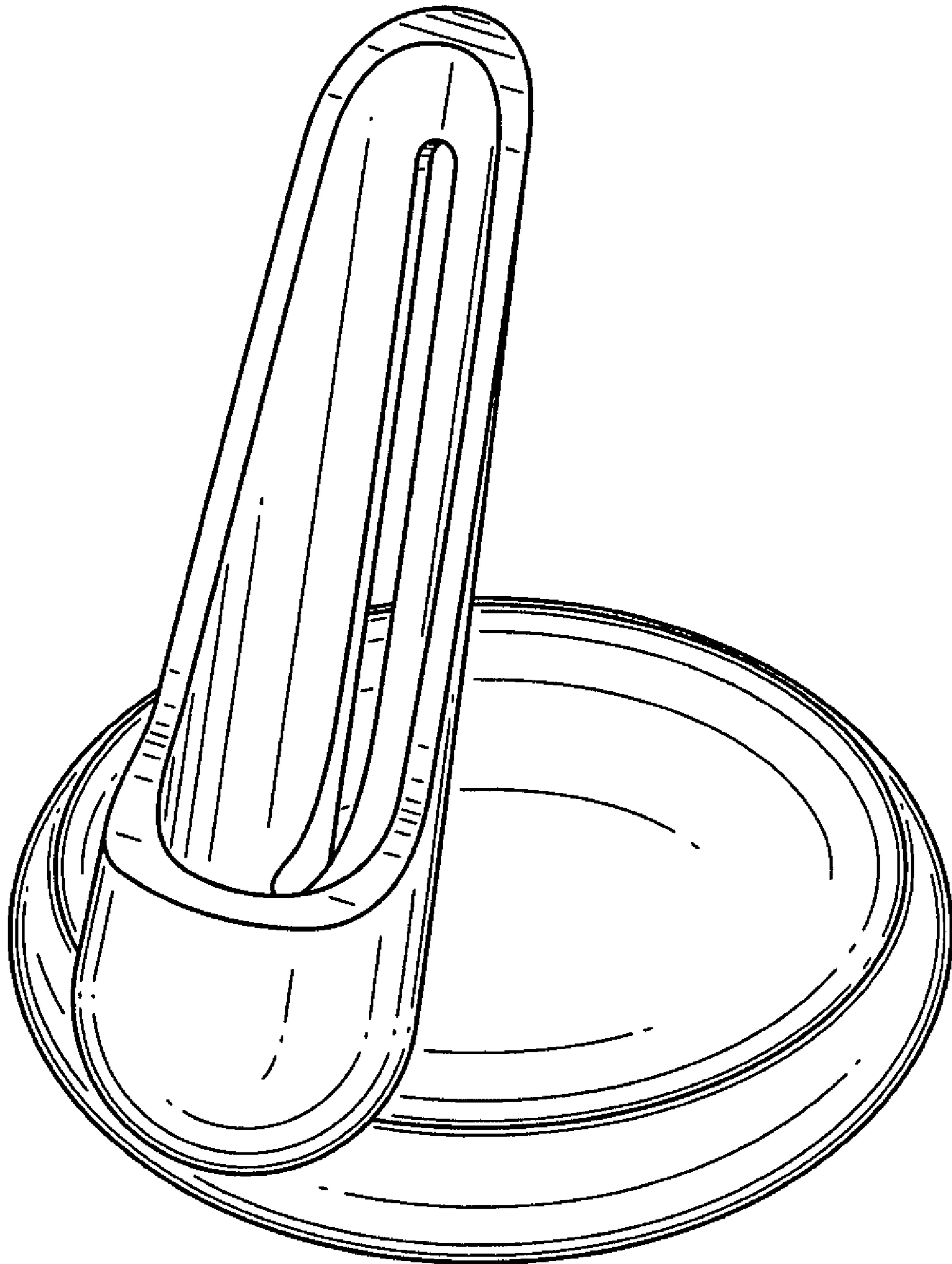

FIG. 3

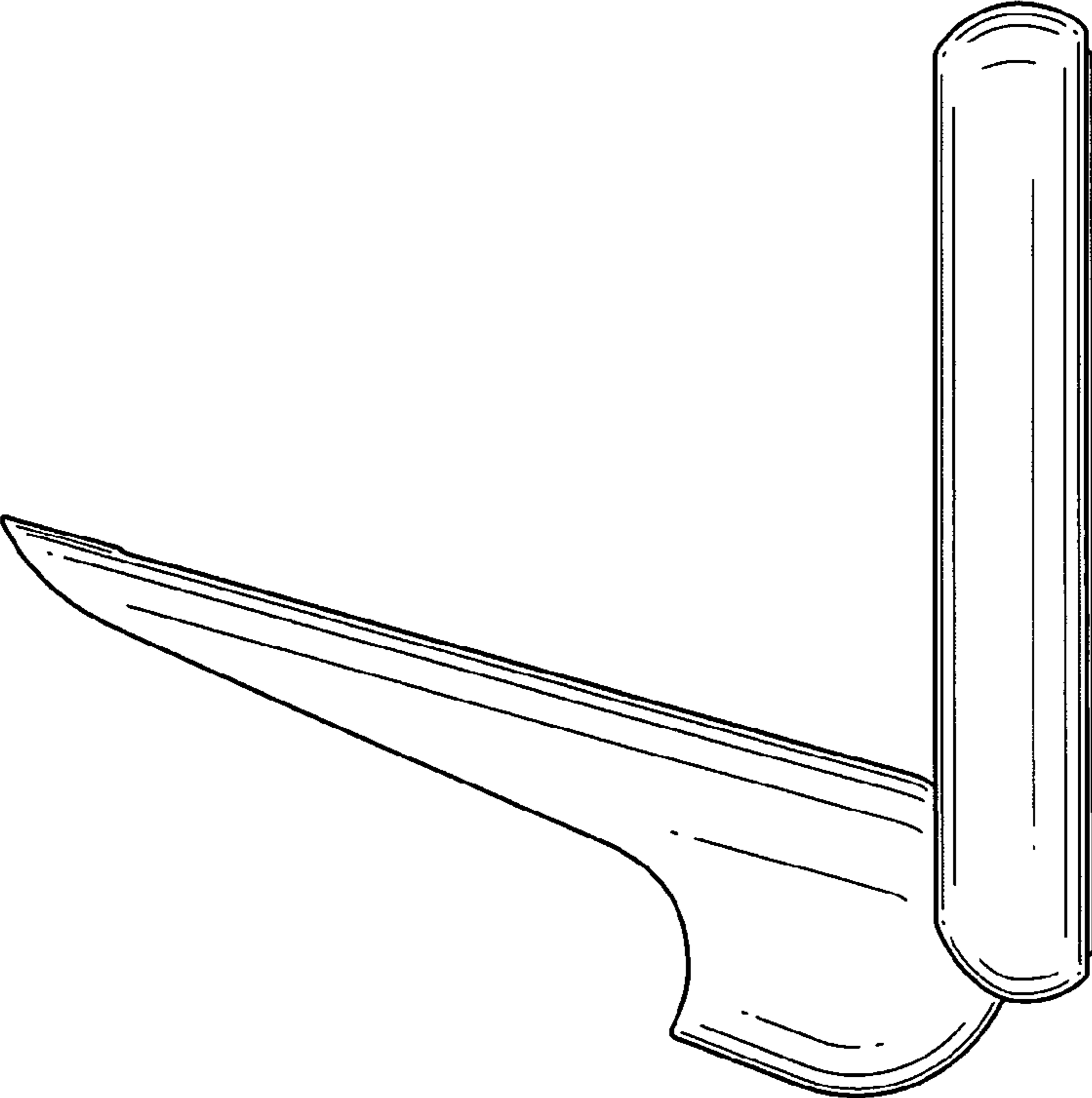

FIG. 2

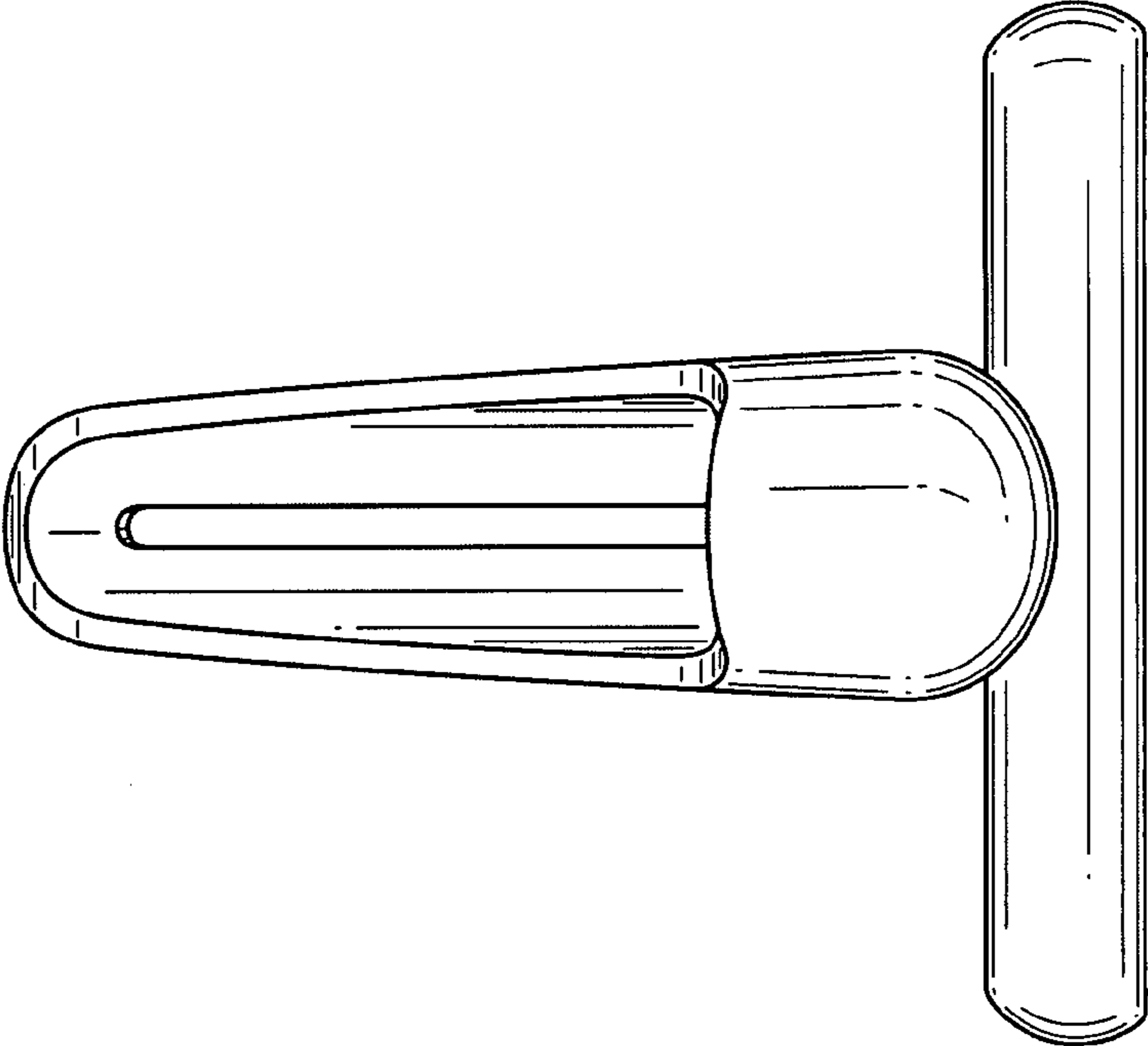

FIG. 5

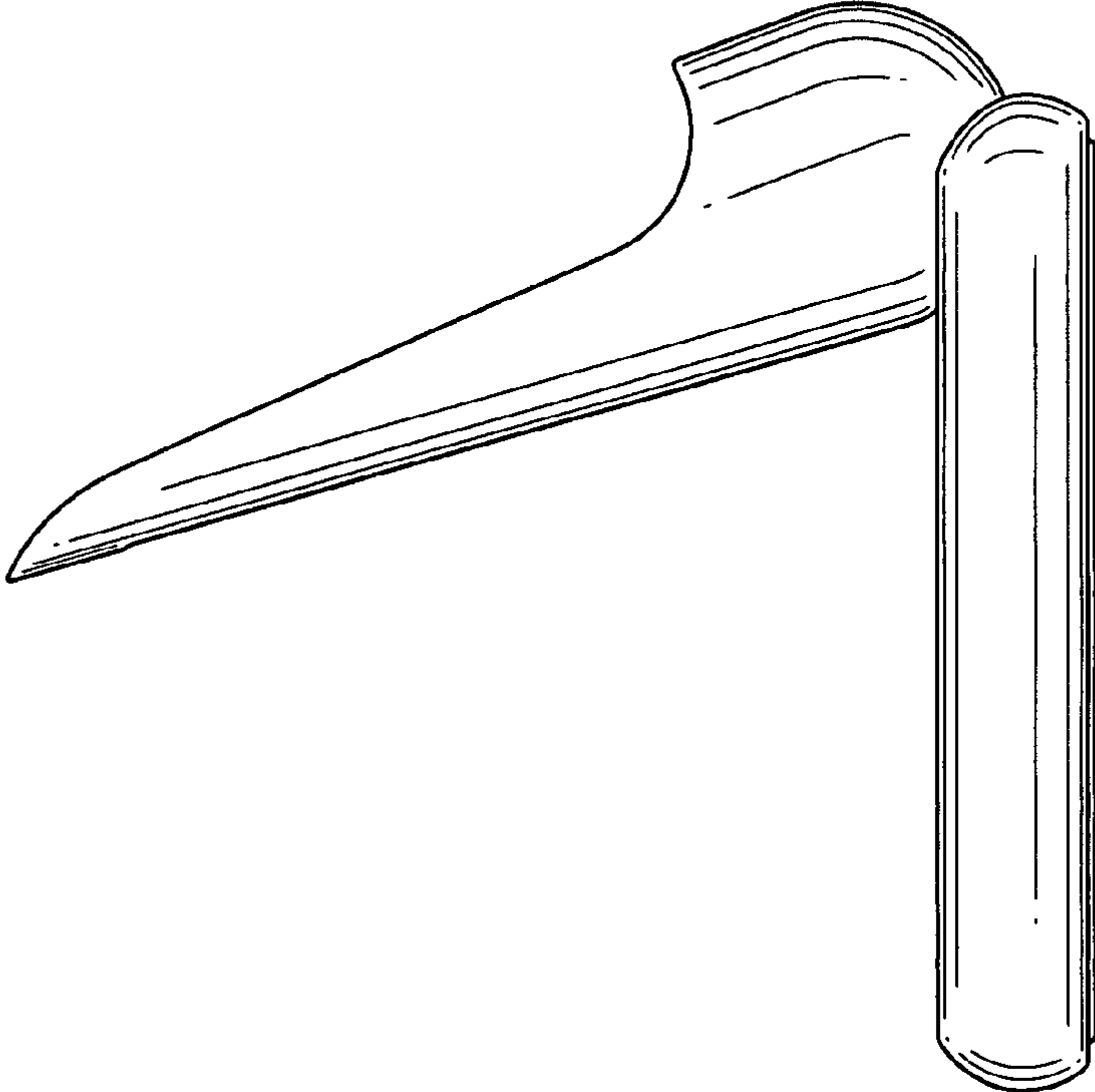

FIG. 4

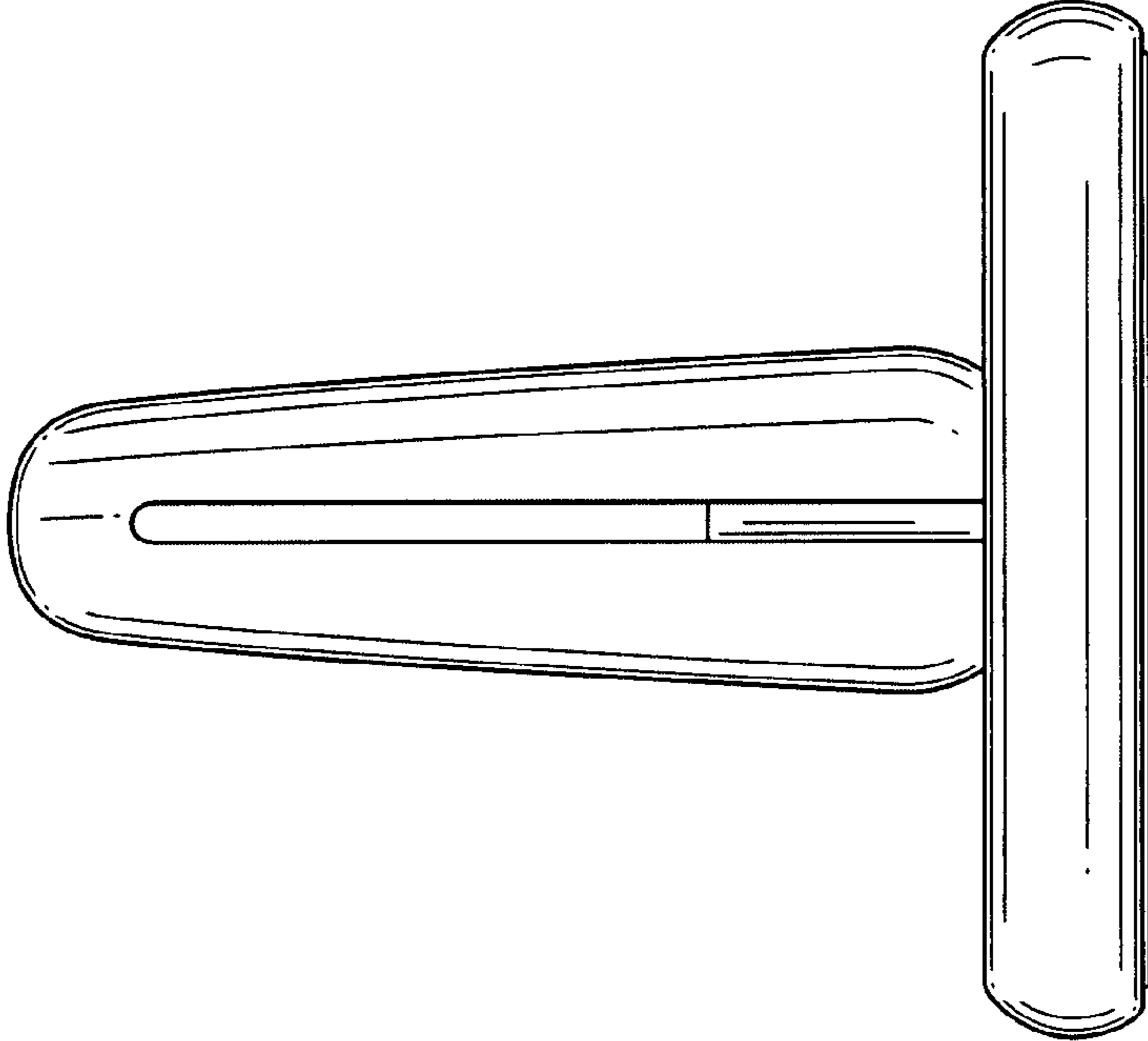

FIG. 6

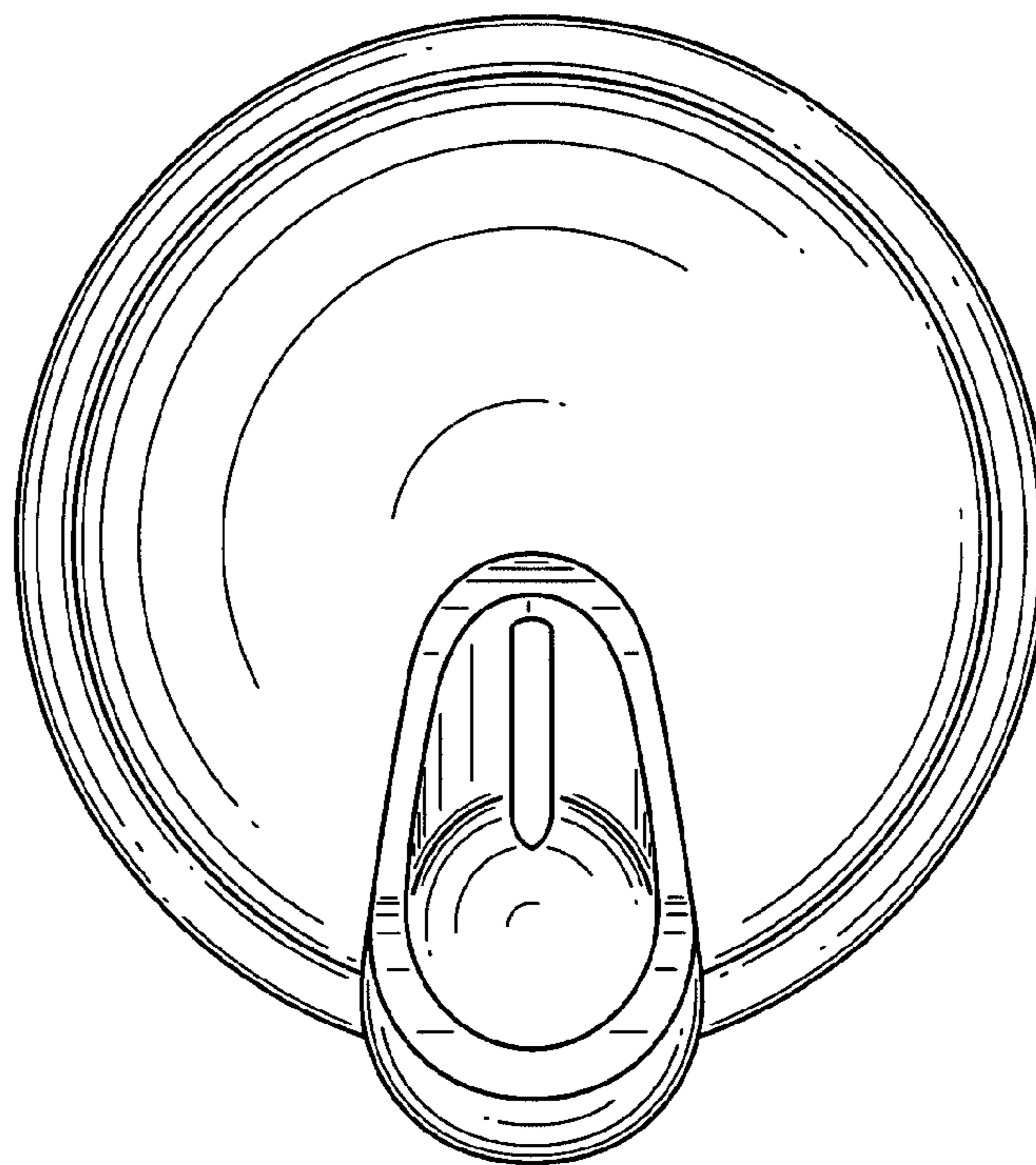

FIG. 7

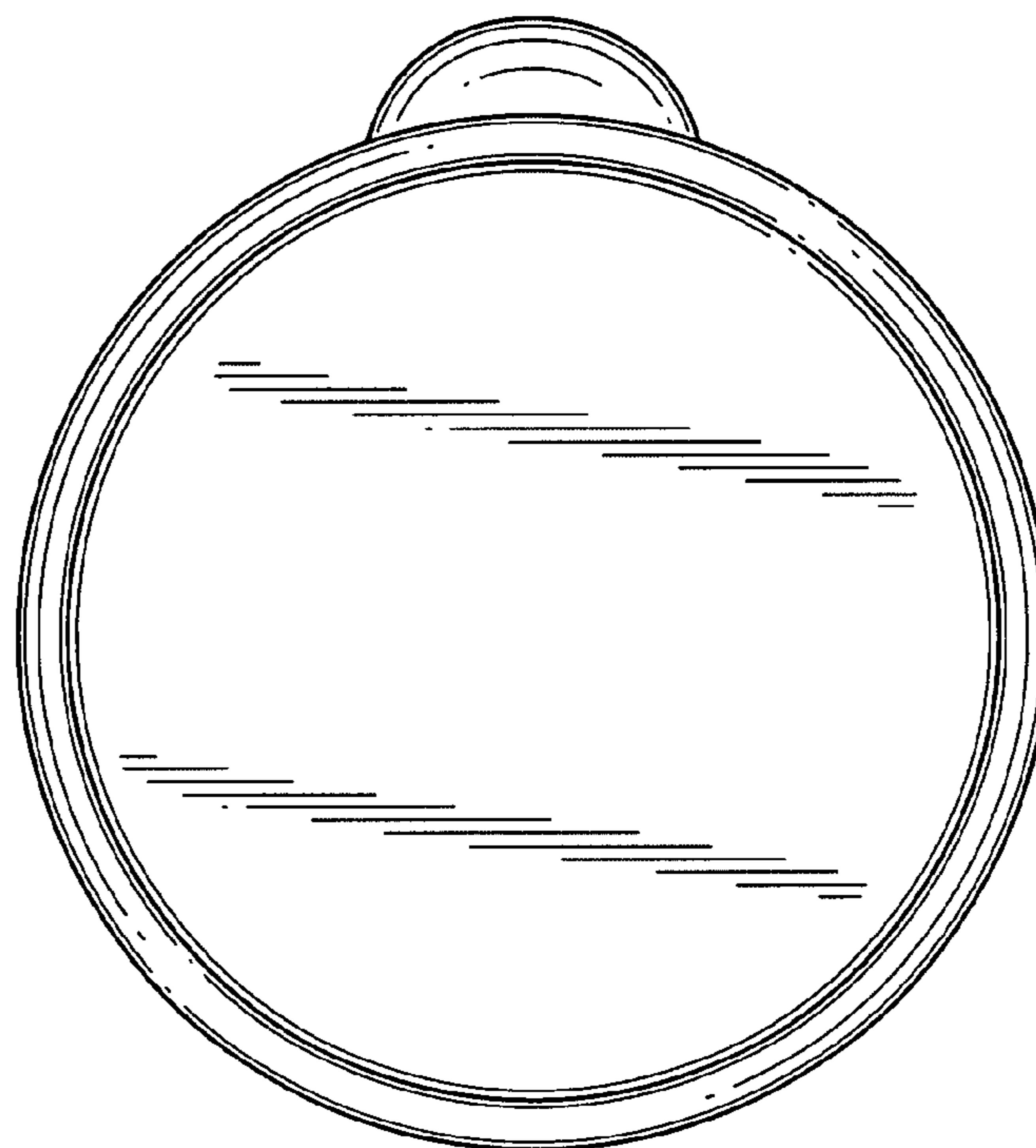

FIG. 8

