

US00D571955S

(12) **United States Design Patent**
Wonderley et al.

(10) **Patent No.:** **US D571,955 S**
(45) **Date of Patent:** **** Jun. 24, 2008**

(54) **SHAVING RAZOR**

(75) Inventors: **Jeffrey W. Wonderley**, Fort Defiance, VA (US); **David Stowers**, Morristown, NJ (US); **Benjamin Portnoy**, Morton, PA (US)

(73) Assignee: **American Safety Razor**, Verona, VA (US)

(**) Term: **14 Years**

(21) Appl. No.: **29/273,499**

(22) Filed: **Mar. 7, 2007**

(51) **LOC (8) Cl.** **28-03**

(52) **U.S. Cl.** **D28/48**

(58) **Field of Classification Search** D28/44-54;
30/30, 32, 34.05, 34.1, 34.2, 41-41.9, 44-45,
30/43-43.92, 47-51, 57-58, 346.5-346.61,
30/526-527, 532, 533, 537-540

See application file for complete search history.

(56) **References Cited**

U.S. PATENT DOCUMENTS

D56,283 S	9/1920	Johnson	
2,580,058 A	12/1951	Willhelm	
D174,120 S	3/1955	Glaberson	
D195,272 S	5/1963	Munson et al.	
D208,619 S	9/1967	Baker et al.	
4,380,122 A	4/1983	Jagger	
4,926,521 A	5/1990	Gagnepain	
D386,821 S	11/1997	Shurtleff et al.	
D403,113 S	12/1998	Kohring et al.	
D403,114 S	12/1998	Shurtleff	
D407,851 S	4/1999	Shurtleff	
D408,101 S	4/1999	Shurtleff	
D414,298 S	9/1999	Pennella et al.	
D425,250 S	5/2000	Gray	
D445,958 S	7/2001	Dansreau et al.	
D446,884 S	8/2001	Kohring et al.	
D458,410 S	6/2002	Shepperson	
D478,687 S	8/2003	Provost	
D482,161 S	* 11/2003	Yamagishi et al. D28/48

D495,826 S	9/2004	Ham et al.	
D499,210 S	11/2004	Shepperson et al.	
D500,170 S	12/2004	Jung	
6,886,262 B2	5/2005	Ohtsubo et al.	
D506,035 S	6/2005	Dombrowski et al.	
D511,024 S	10/2005	Dombrowski et al.	
D515,243 S	2/2006	Dibnah et al.	
D524,984 S	7/2006	Ramm et al.	
D534,314 S	* 12/2006	Lee D28/46
D541,474 S	* 4/2007	Psimadas et al. D28/48
D541,987 S	* 5/2007	Sugawara D28/46
D542,470 S	* 5/2007	Bunnell et al. D28/48
2004/0103545 A1	6/2004	Dansreau	

FOREIGN PATENT DOCUMENTS

DE	44 30 738 A1	5/1995
JP	10-43444	2/1998
JP	2003-236272	8/2003
JP	2005-261543	9/2005
WO	WO 97/09155	3/1997
WO	WO 97/12732	4/1997
WO	WO 2005/048772 A1	6/2005

* cited by examiner

Primary Examiner—Jennifer Rivard

(74) *Attorney, Agent, or Firm*—McDermott Will & Emery LLP

(57) **CLAIM**

We claim the ornamental design for a shaving razor, substantially as shown and described.

DESCRIPTION

FIG. 1 is a perspective view of the shaving razor showing the new design;

FIG. 2 is a front view of the shaving razor;

FIG. 3 is a rear view of the shaving razor;

FIG. 4 is a side view of the shaving razor;

FIG. 5 is another side view of the shaving razor;

FIG. 6 is a top view of the shaving razor; and,

FIG. 7 is a bottom view of the shaving razor.

The broken lines are for illustrative purposes only and form no part of the claimed design.

1 Claim, 5 Drawing Sheets

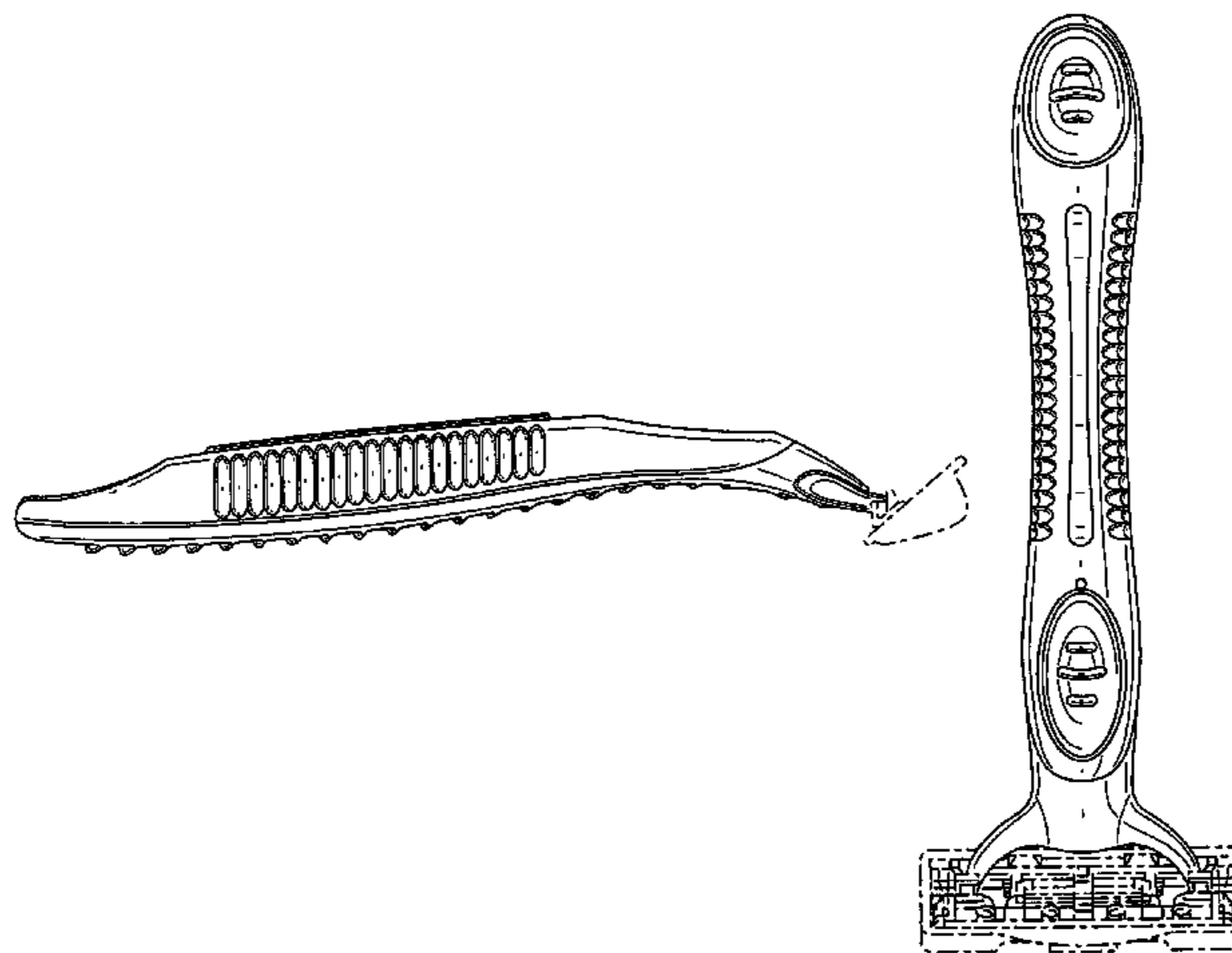

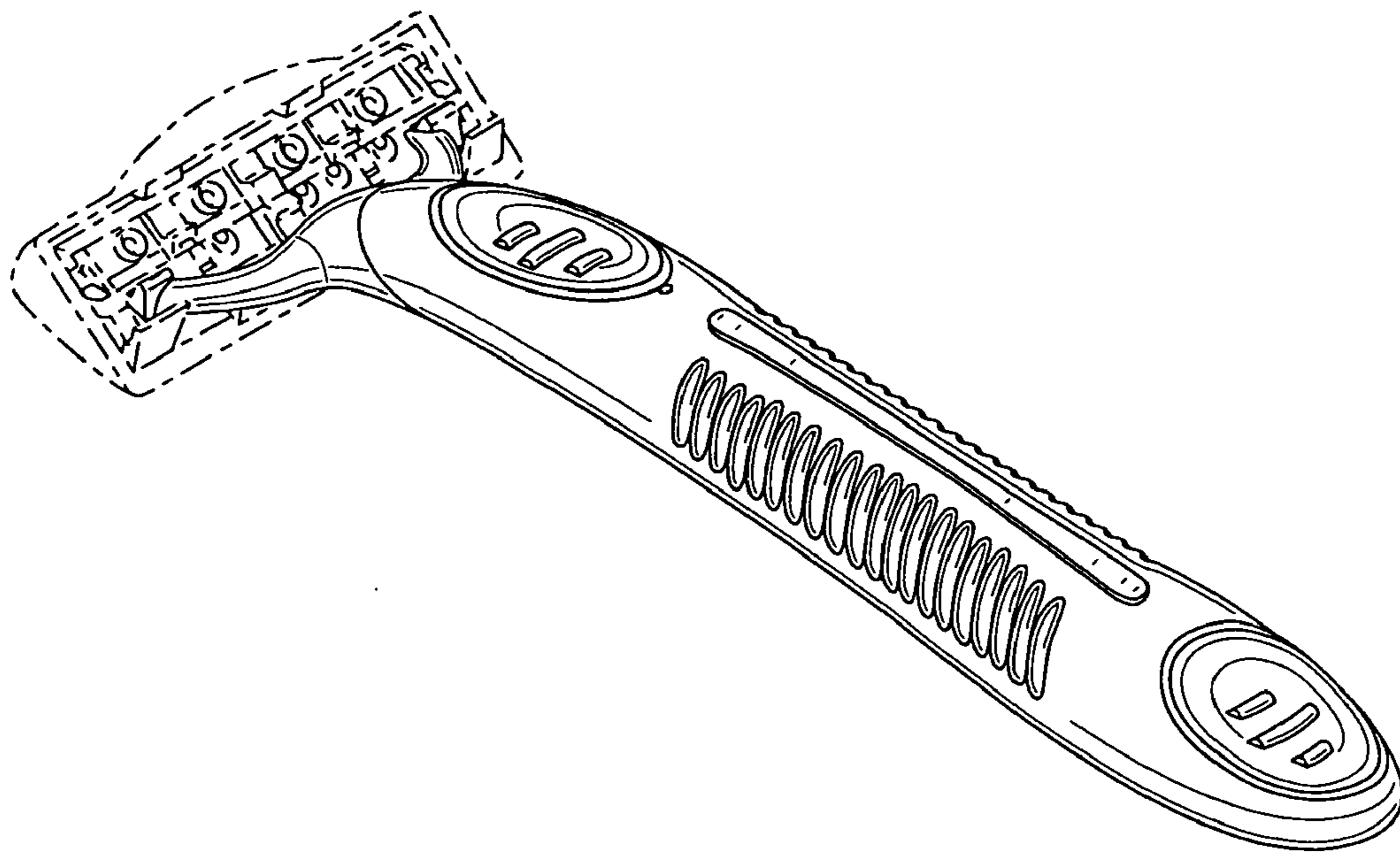

FIG. 1

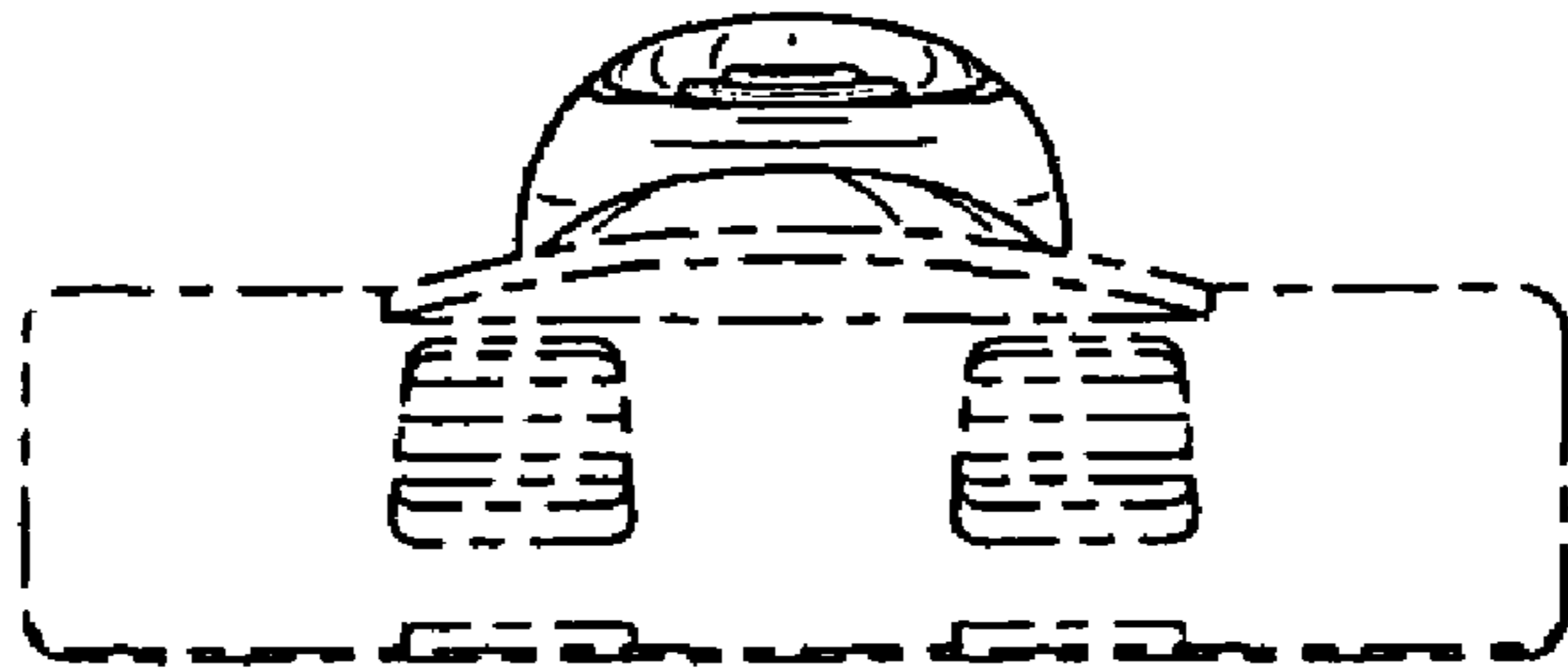

FIG. 2

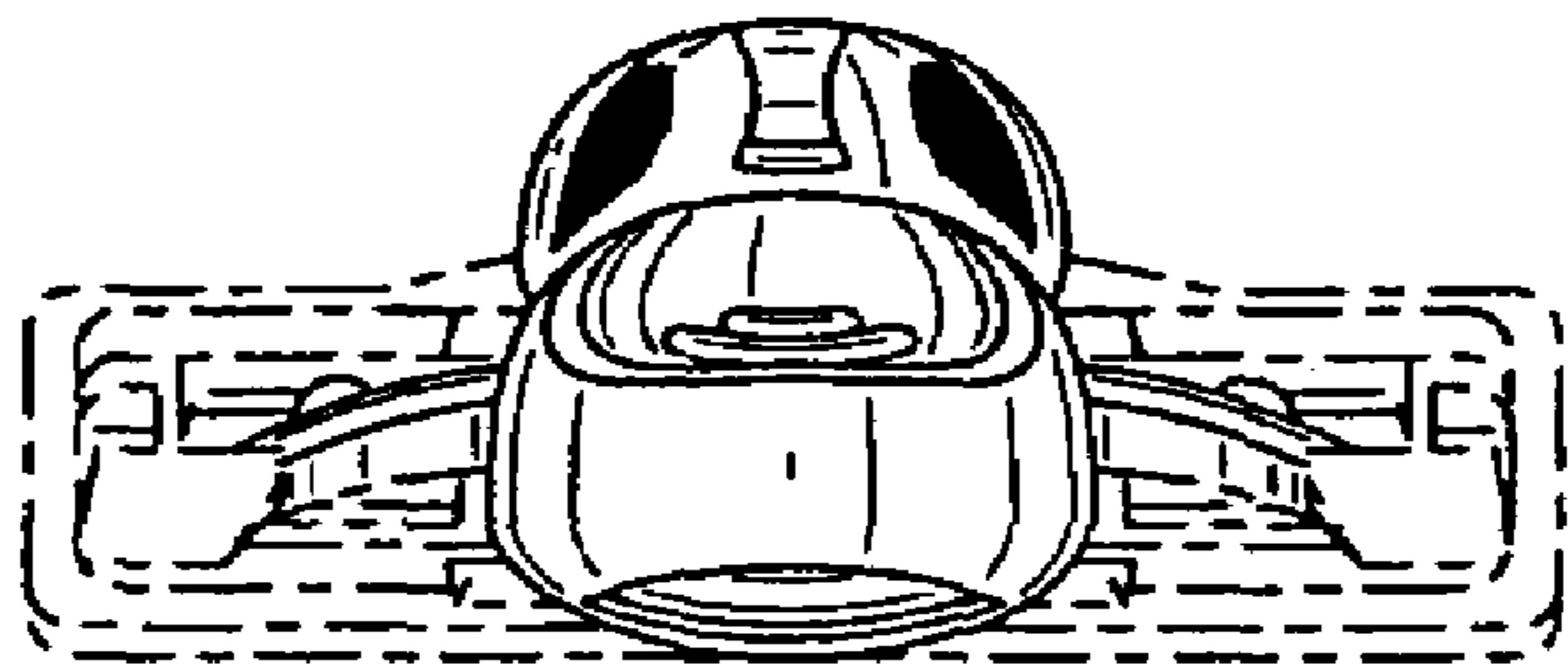

FIG. 3

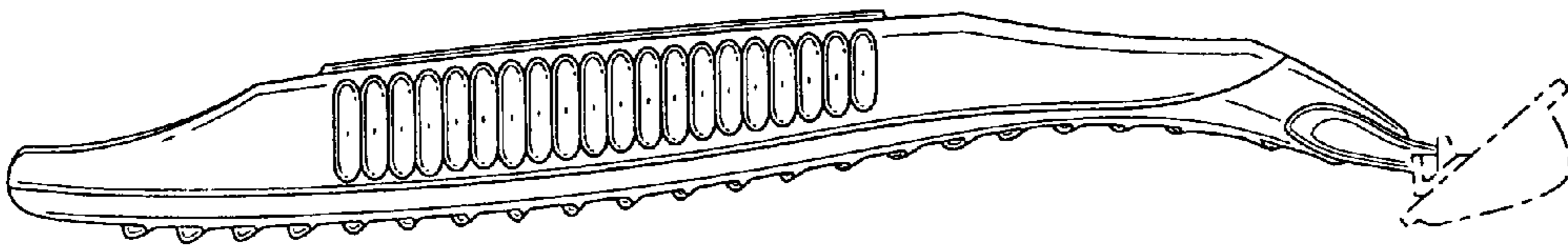

FIG. 4

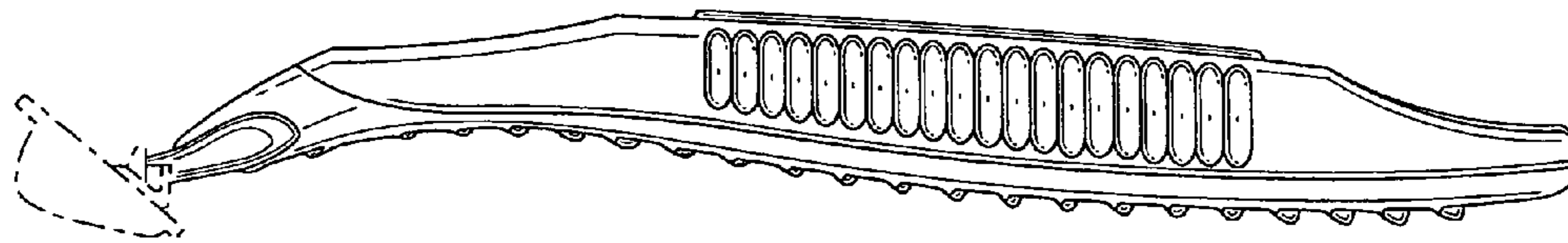

FIG. 5

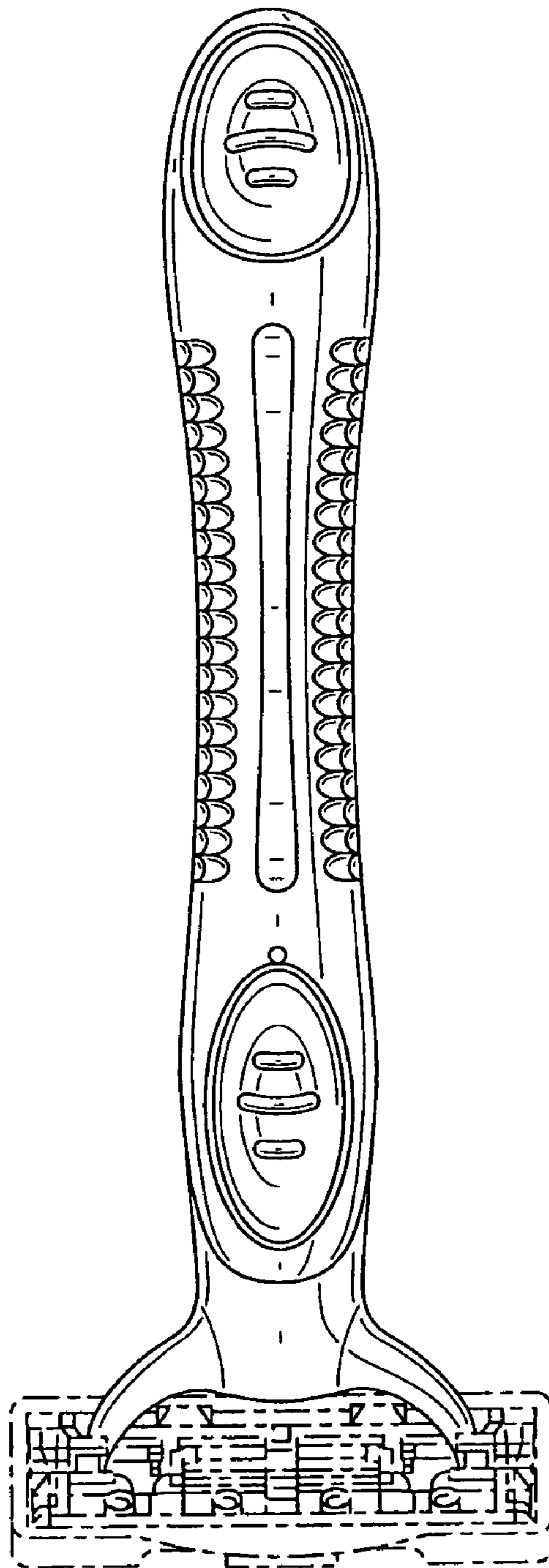

FIG. 6

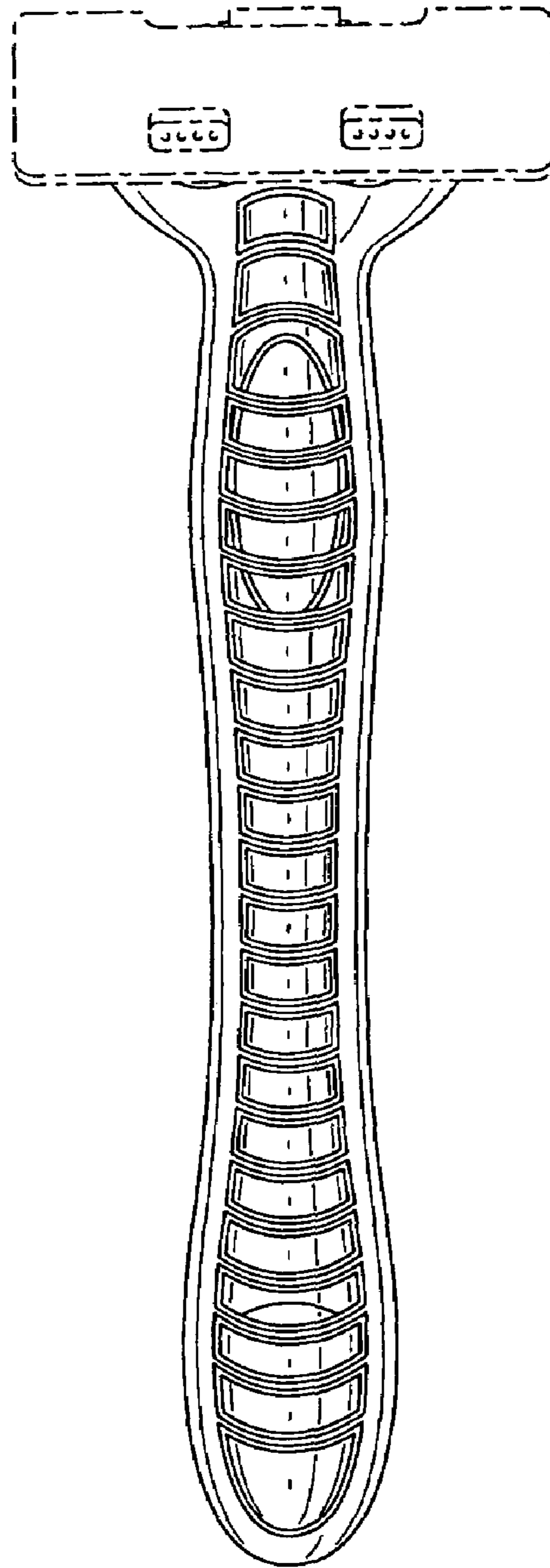

FIG. 7