



US00D571831S

(12) **United States Design Patent**
Ota et al.

(10) **Patent No.:** **US D571,831 S**
(45) **Date of Patent:** **** Jun. 24, 2008**

(54) **TOP PANEL FOR MICROWAVE INTRODUCTION WINDOW OF A PLASMA PROCESSING APPARATUS**

4,779,748 A * 10/1988 King 215/256
4,858,590 A * 8/1989 Bailey 126/39 H
D309,109 S * 7/1990 Allen D9/436
D315,309 S * 3/1991 Baughman D9/456

(75) Inventors: **Kinya Ota**, Amagasaki (JP); **Cai Zhong Tian**, Amagasaki (JP); **Junichi Kitagawa**, Amagasaki (JP)

(Continued)

(73) Assignee: **Tokyo Electron Limited**, Tokyo (JP)

FOREIGN PATENT DOCUMENTS

(**) Term: **14 Years**

EP 0592017 A2 * 4/1994

(21) Appl. No.: **29/252,832**

OTHER PUBLICATIONS

(22) Filed: **Jan. 30, 2006**

Asian Sources Hardwares for World Markets, Nov. 1990, p. 251.

(30) **Foreign Application Priority Data**

Primary Examiner—Sandra Snapp
Assistant Examiner—Patricia Palasik
(74) *Attorney, Agent, or Firm*—Oblon, Spivak, McClelland, Maier & Neustadt, P.C.

Jul. 29, 2005 (JP) 2005-022107

(51) **LOC (8) Cl.** **15-09**

(57) **CLAIM**

(52) **U.S. Cl.** **D15/138; D15/199**

The ornamental design for a top panel for microwave introduction window of a plasma processing apparatus, as shown and described.

(58) **Field of Classification Search** D7/586, D7/587, 501, 553.6, 600.4; D8/70, 74; D9/445, D9/454, 456; D15/133, 144.1, 199, 122, D15/138, 139; 117/103; 118/723 AN, 723 ME, 118/723 MP, 723 MW, 723 E, 723 ER; 216/69, 216/67; 257/E21.252, 252, 629, 631, E39.001; 427/562, 571, 575; D1/126, 128; D6/455; D13/122, 138, 139, 158-177, 182; D18/17; 156/242, 345; 175/374, 434; 204/298.8; 219/420-424, 523, 530, 541, 544; 264/328.14, 264/328.15, 328.16; 313/231.31; 315/111.21; 407/113-118; 408/145; 425/547-550, 564, 425/566, 570; 451/541-548; 700/121, 123
See application file for complete search history.

DESCRIPTION

FIG. 1 is a front view of a top panel for microwave introduction window of a plasma processing apparatus showing our new design;
FIG. 2 is a rear view thereof;
FIG. 3 is a right side view thereof;
FIG. 4 is a left side view thereof;
FIG. 5 is a top plan view thereof;
FIG. 6 is a bottom plan view thereof;
FIG. 7 is a sectional view taken along line 7-7 of FIG. 5;
FIG. 8 is an enlarged view taken along line 8-8 of FIG. 7;
FIG. 9 is an enlarged view taken along line 9-9 of FIG. 7; and,
FIG. 10 is a perspective view thereof.

(56) **References Cited**

U.S. PATENT DOCUMENTS

D239,437 S * 4/1976 Boduch D9/445
4,048,845 A * 9/1977 Gilbert 73/45.5
4,122,964 A * 10/1978 Morris 215/260
4,213,537 A * 7/1980 Caccavale 220/215
D265,176 S * 6/1982 Bock D9/454

1 Claim, 4 Drawing Sheets

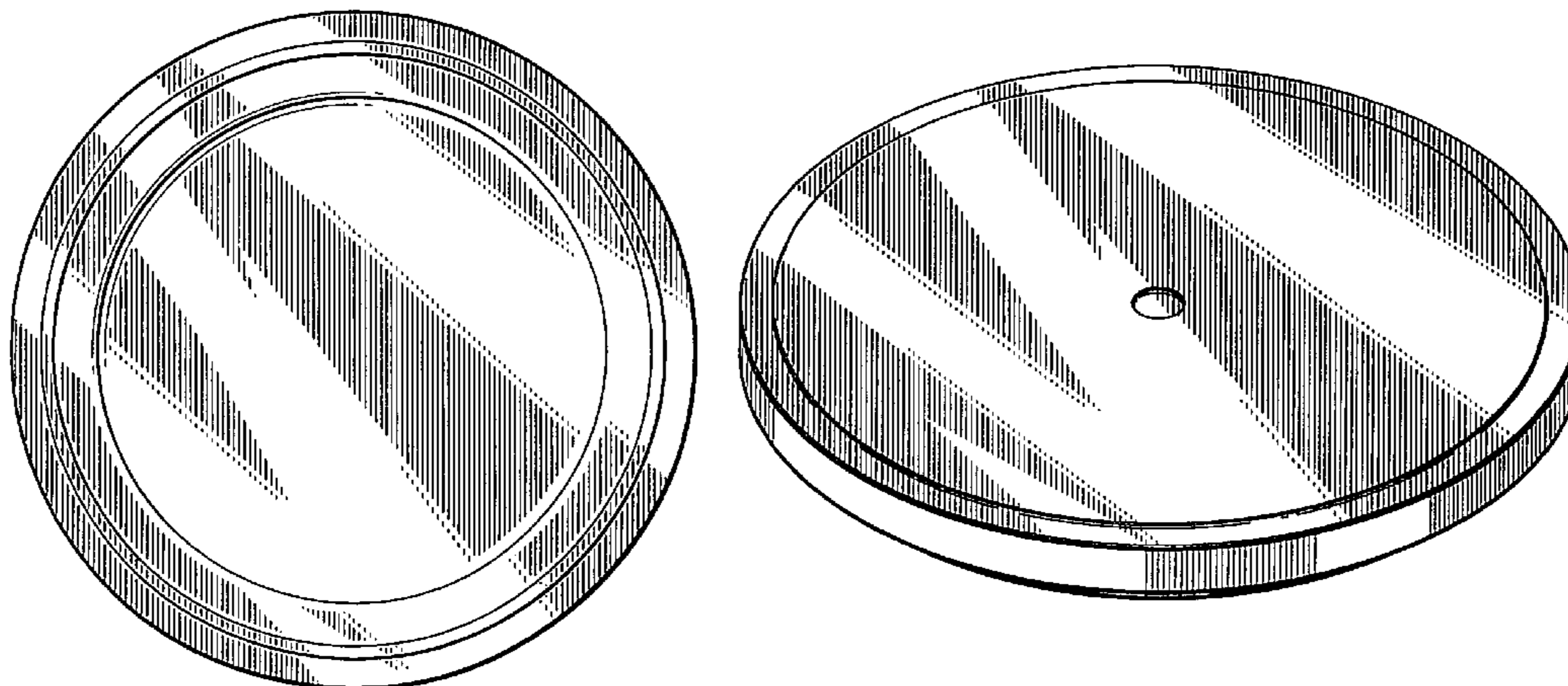

US D571,831 S

Page 2

U.S. PATENT DOCUMENTS

D328,837 S *	8/1992	Marsten et al.	D7/585	D442,864 S *	5/2001	Davies	D9/454
5,335,801 A *	8/1994	Lee	215/249	6,345,718 B1 *	2/2002	Minogue	206/540
D357,385 S *	4/1995	Addison et al.	D7/407	6,403,933 B1 *	6/2002	Strodtbeck et al.	219/502
5,486,131 A *	1/1996	Cesna et al.	451/56	6,578,853 B1 *	6/2003	Treur et al.	279/121
5,569,062 A *	10/1996	Karlsruud	451/285	7,153,199 B1 *	12/2006	Decker	451/343
5,645,645 A *	7/1997	Zhang et al.	118/723 MW	2003/0232151 A1 *	12/2003	Vukovic	427/571
D386,792 S *	11/1997	Miller	D20/21	2005/0194337 A1 *	9/2005	McDaniel	211/165
D399,245 S *	10/1998	Harden	D18/15	2005/0199159 A1 *	9/2005	Searer	108/94
5,948,704 A *	9/1999	Benjamin et al.	438/715	2006/0049270 A1 *	3/2006	Wayne	239/57
6,108,190 A *	8/2000	Nagasaki	361/234				

* cited by examiner

FIG.1

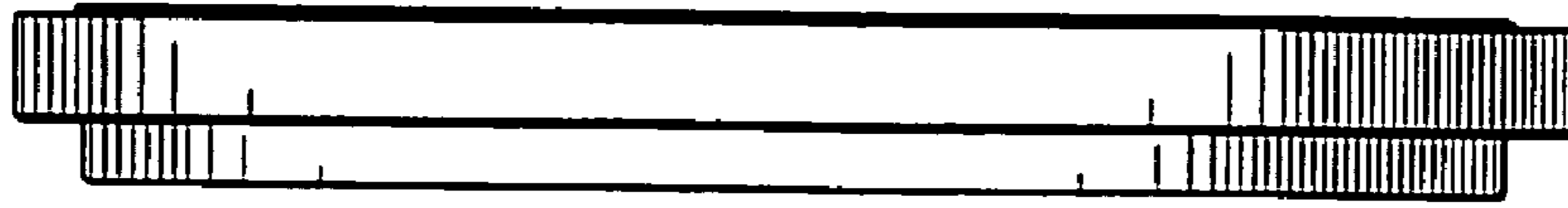

FIG.2

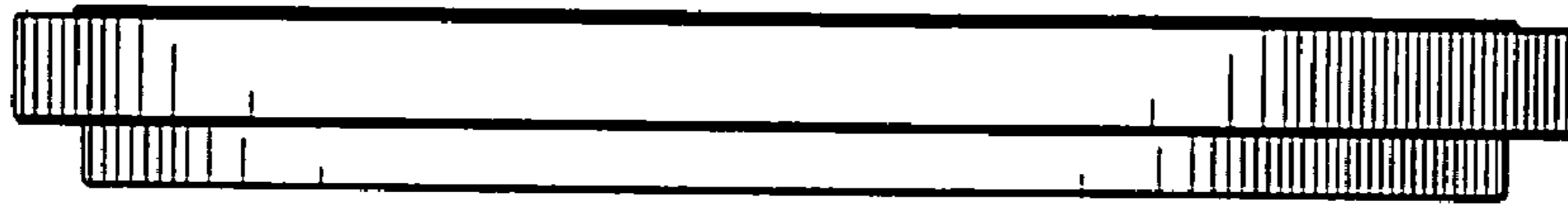

FIG.3



FIG.4

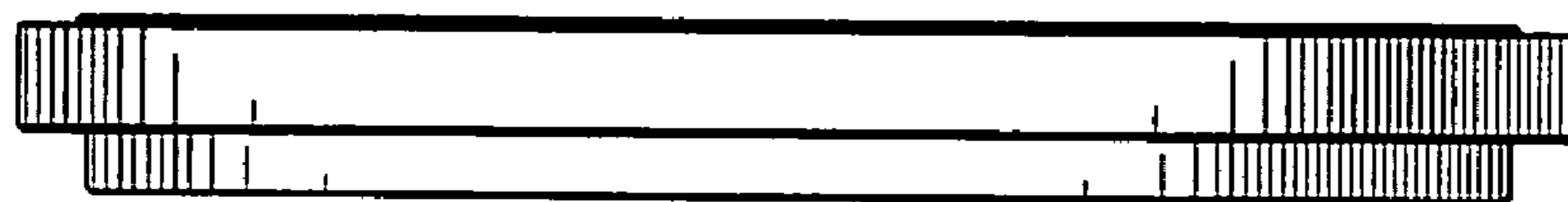

FIG.5

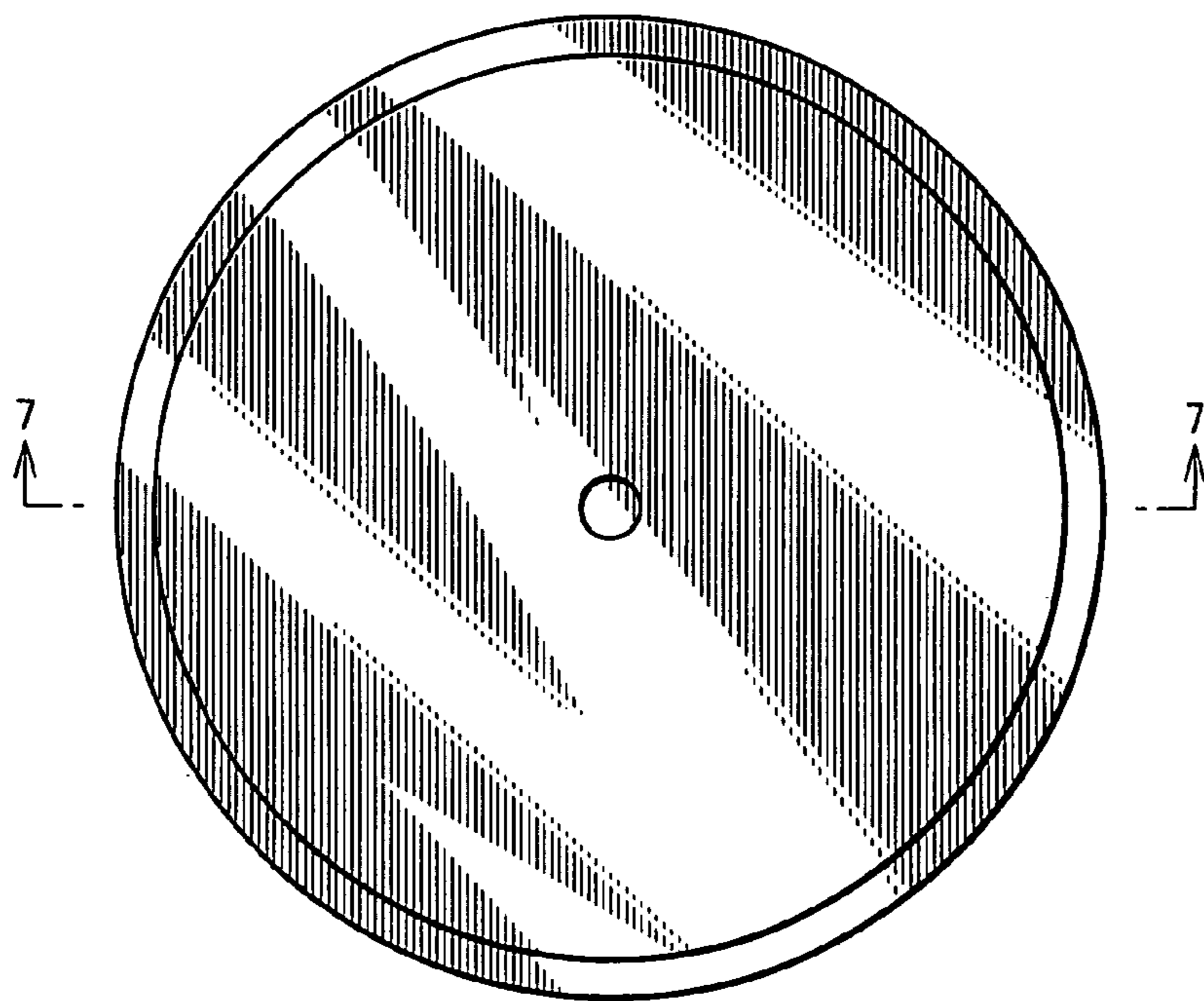
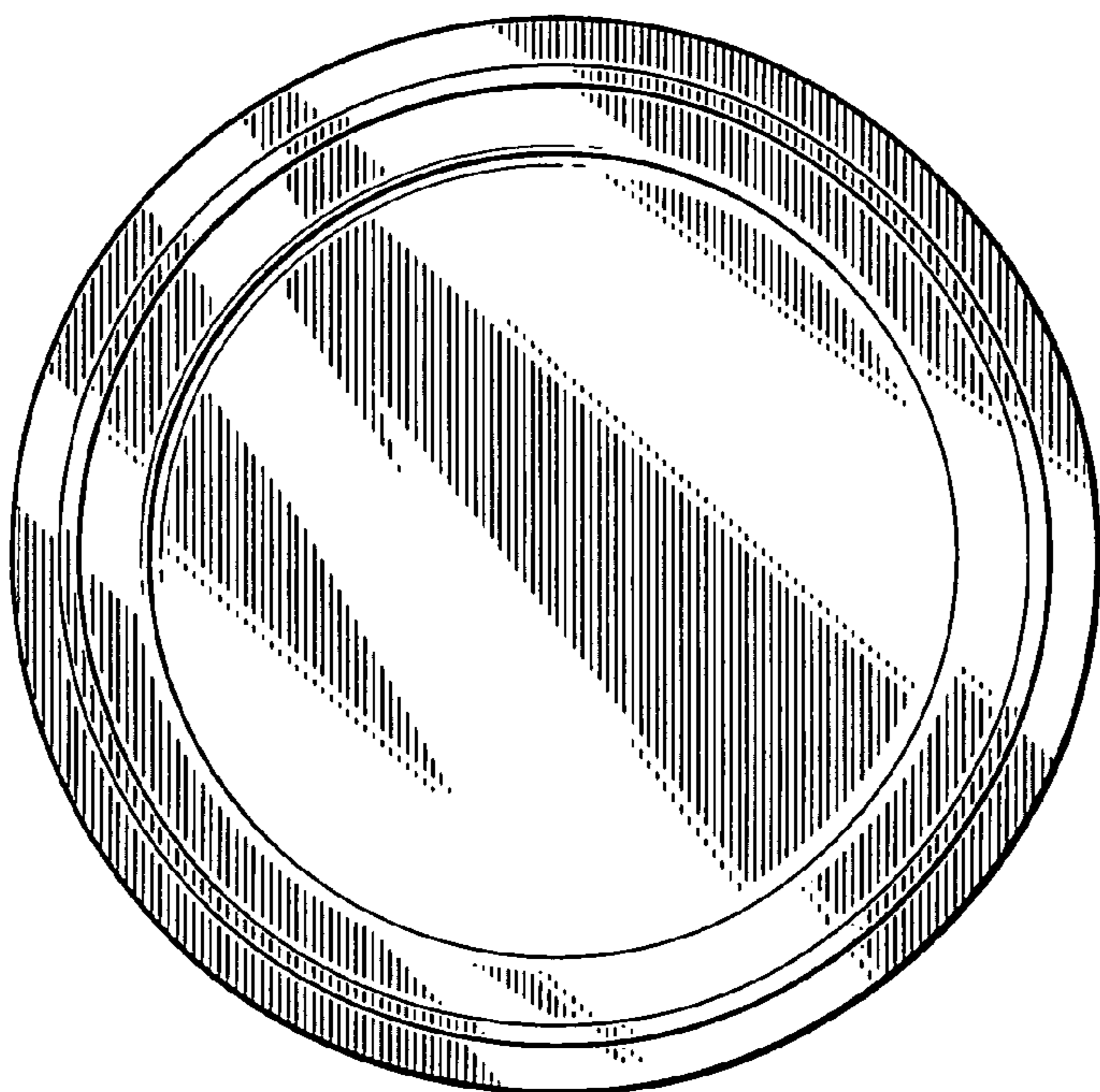

FIG.6



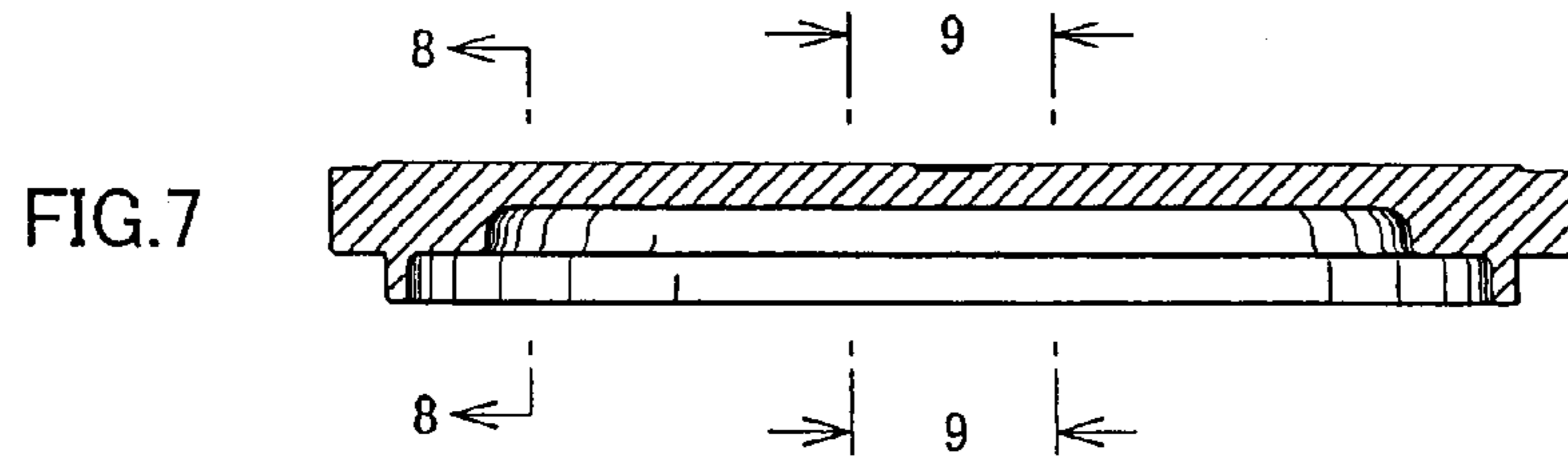

FIG.8

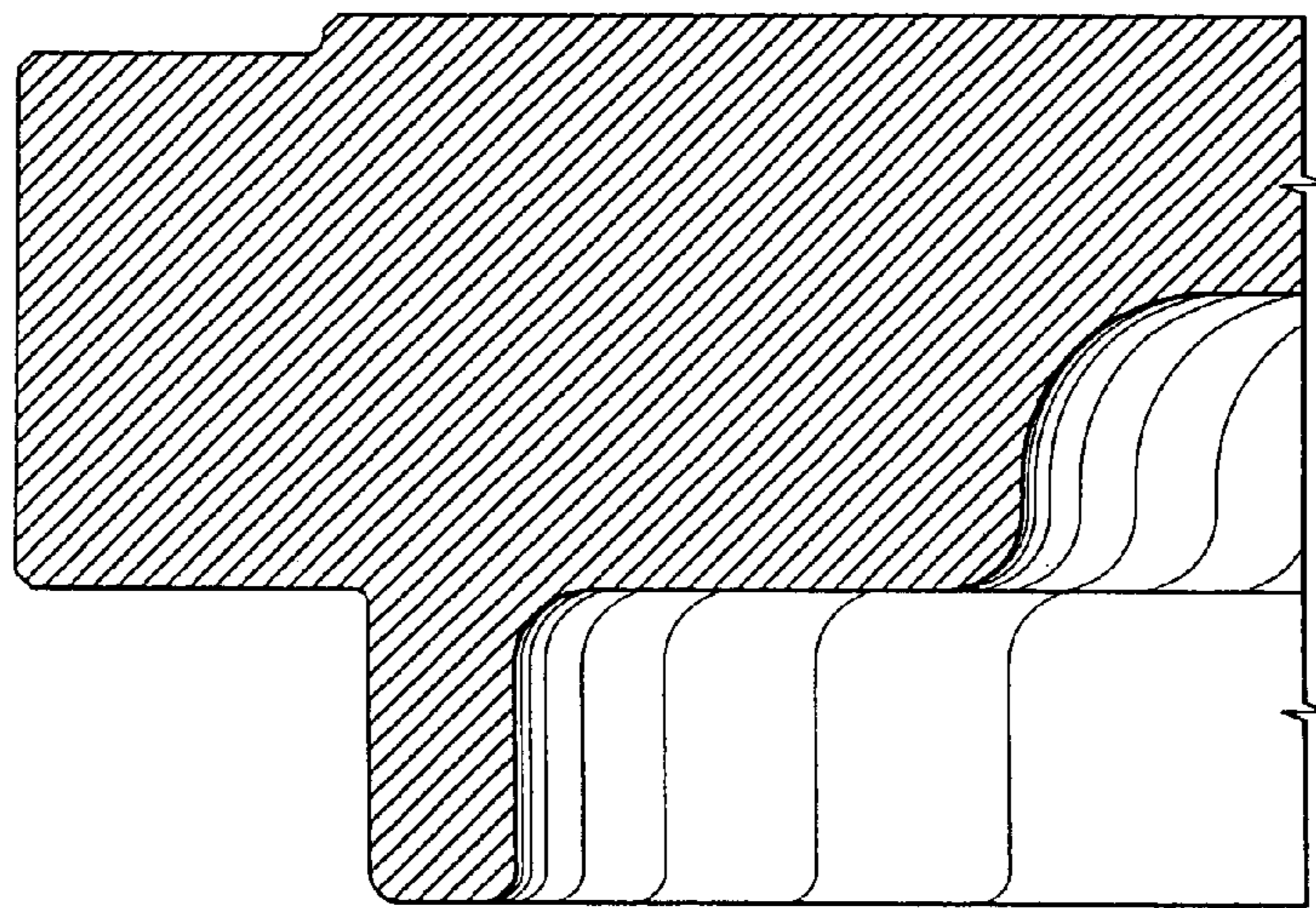

FIG.9

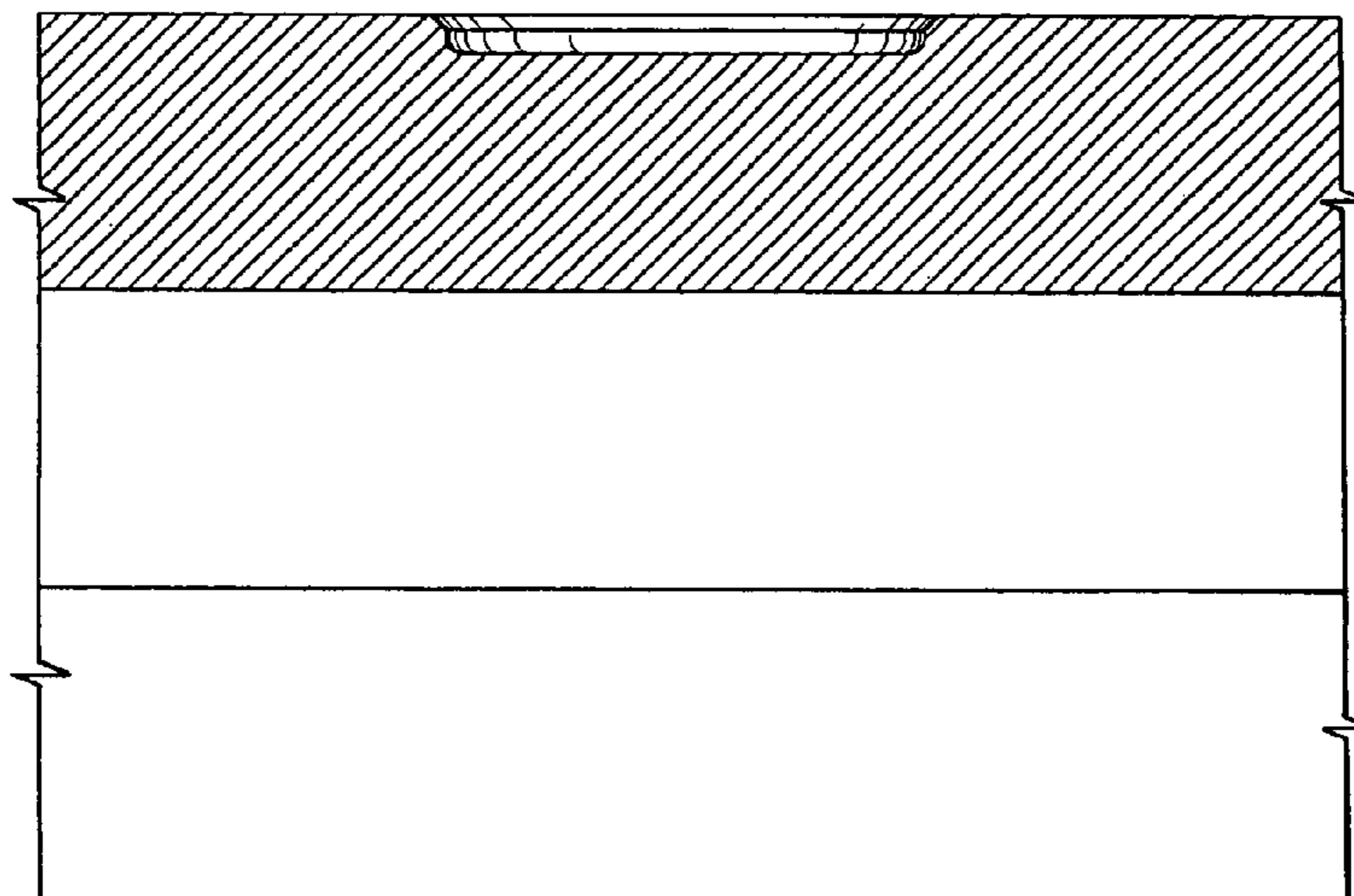

FIG.10

