



US00D571682S

(12) **United States Design Patent**
Tsui

(10) **Patent No.:** **US D571,682 S**
(45) **Date of Patent:** **** Jun. 24, 2008**

(54) **FLASHING LIGHT FOR WARNING SIGN**

(75) Inventor: **Chi-Wah Tsui**, New Territories (HK)

(73) Assignee: **East Trillion Company Limited**,
Kowloon (HK)

(**) Term: **14 Years**

(21) Appl. No.: **29/288,326**

(22) Filed: **Jun. 6, 2007**

(51) **LOC (8) Cl.** **10-05**

(52) **U.S. Cl.** **D10/114**

(58) **Field of Classification Search** D10/109,
D10/111, 114; 340/815, 432, 908.1, 815.03,
340/760, 761, 767, 782, 471, 473, 45, 331;
362/311, 373, 35, 186, 183, 200, 196, 191;
320/102

See application file for complete search history.

(56) **References Cited**

U.S. PATENT DOCUMENTS

2,918,668	A *	12/1959	Stube	340/331
2,931,026	A *	3/1960	Nelson	340/815.73
3,221,300	A *	11/1965	Elledge, Jr.	340/908.1
3,266,015	A *	8/1966	Pickering et al.	340/331
3,321,742	A *	5/1967	Nunn, Jr.	340/908.1
3,523,290	A *	8/1970	Elledge, Jr.	340/331
4,408,264	A *	10/1983	Decker	362/200
4,482,941	A *	11/1984	Lindner	362/186
4,772,990	A *	9/1988	Linehan et al.	362/183

4,884,017	A *	11/1989	Williams	320/102
D320,173	S *	9/1991	Yuen	D10/114
D320,174	S *	9/1991	Yuen	D10/114
D324,347	S *	3/1992	Williams	D10/114
5,490,045	A *	2/1996	Lindner	362/35
5,664,874	A *	9/1997	Winterer	362/191
6,150,957	A *	11/2000	Henz et al.	340/908
6,239,691	B1 *	5/2001	Preisler	340/321
7,093,953	B1 *	8/2006	Dicke et al.	362/196

* cited by examiner

Primary Examiner—Robert M. Spear

Assistant Examiner—George D Kirschbaum

(74) *Attorney, Agent, or Firm*—Law Office of Sergei Orel, LLC

(57) **CLAIM**

The ornamental design for a flashing light for warning sign, as shown and described.

DESCRIPTION

FIG. 1 is a top view of the flashing light for warning sign;

FIG. 2 is a front view thereof;

FIG. 3 is a bottom view thereof;

FIG. 4 is a left view thereof;

FIG. 5 is a rear view thereof;

FIG. 6 is a right view thereof; and,

FIG. 7 is a perspective view thereof.

1 Claim, 3 Drawing Sheets

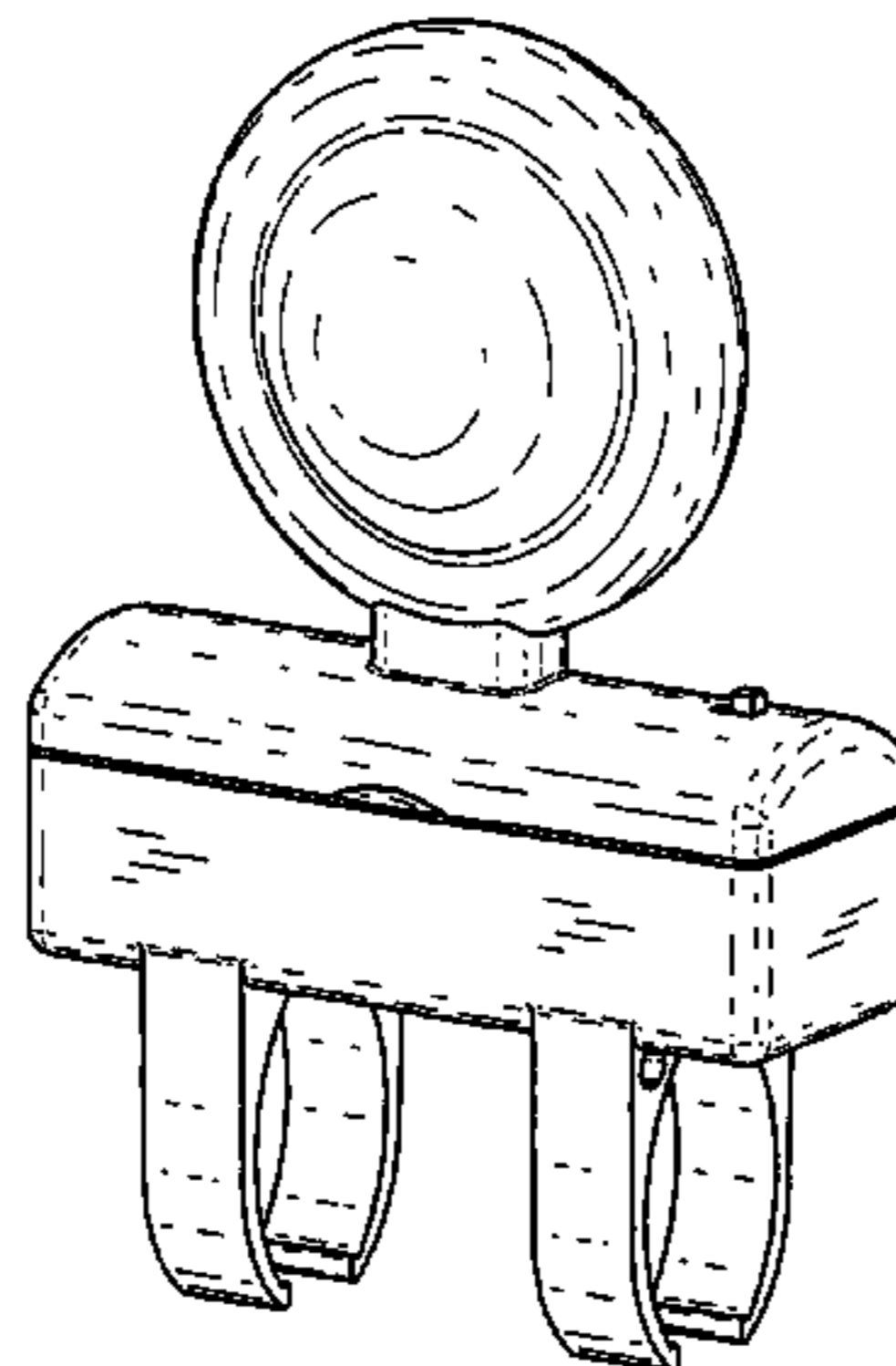
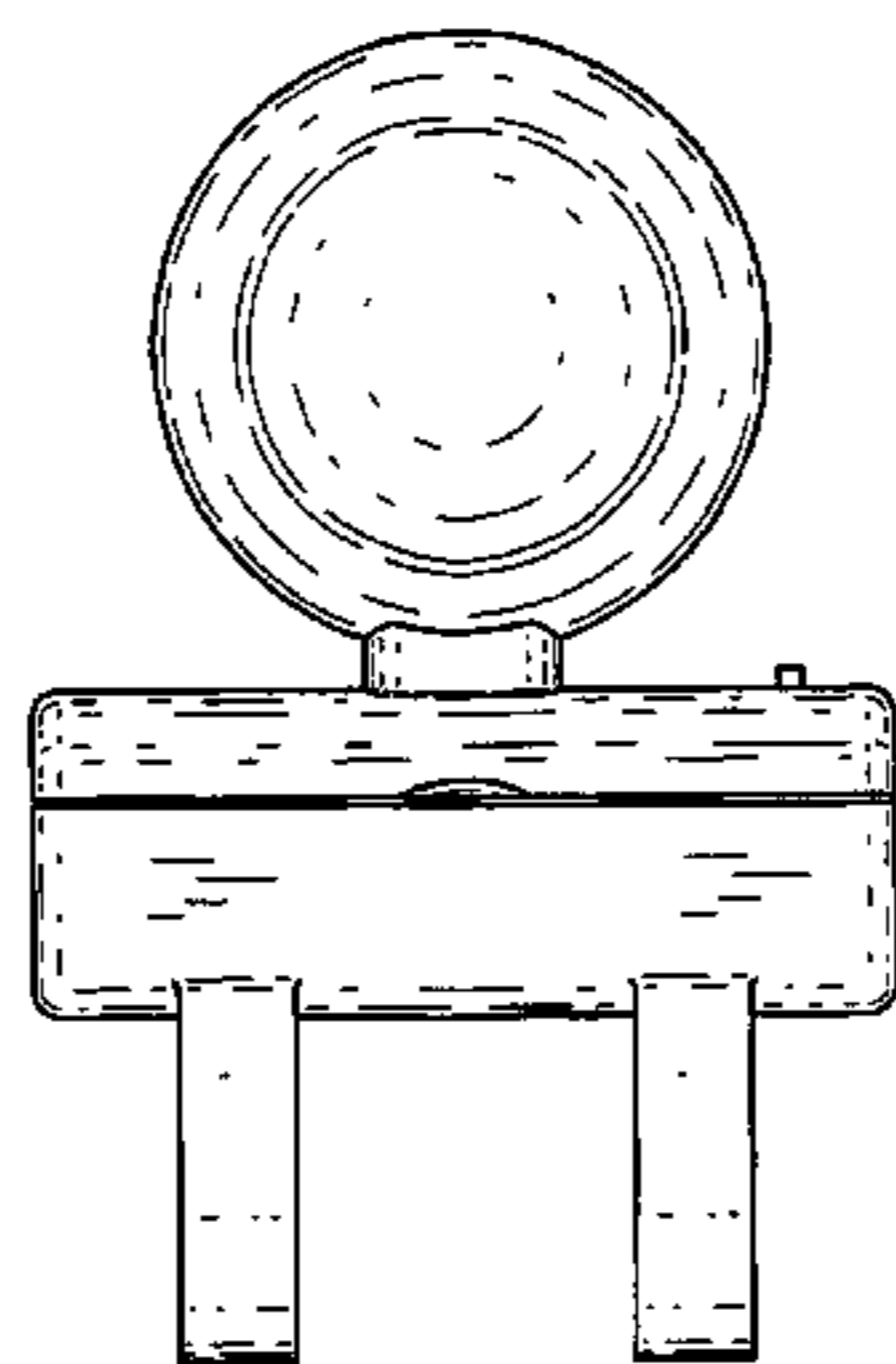

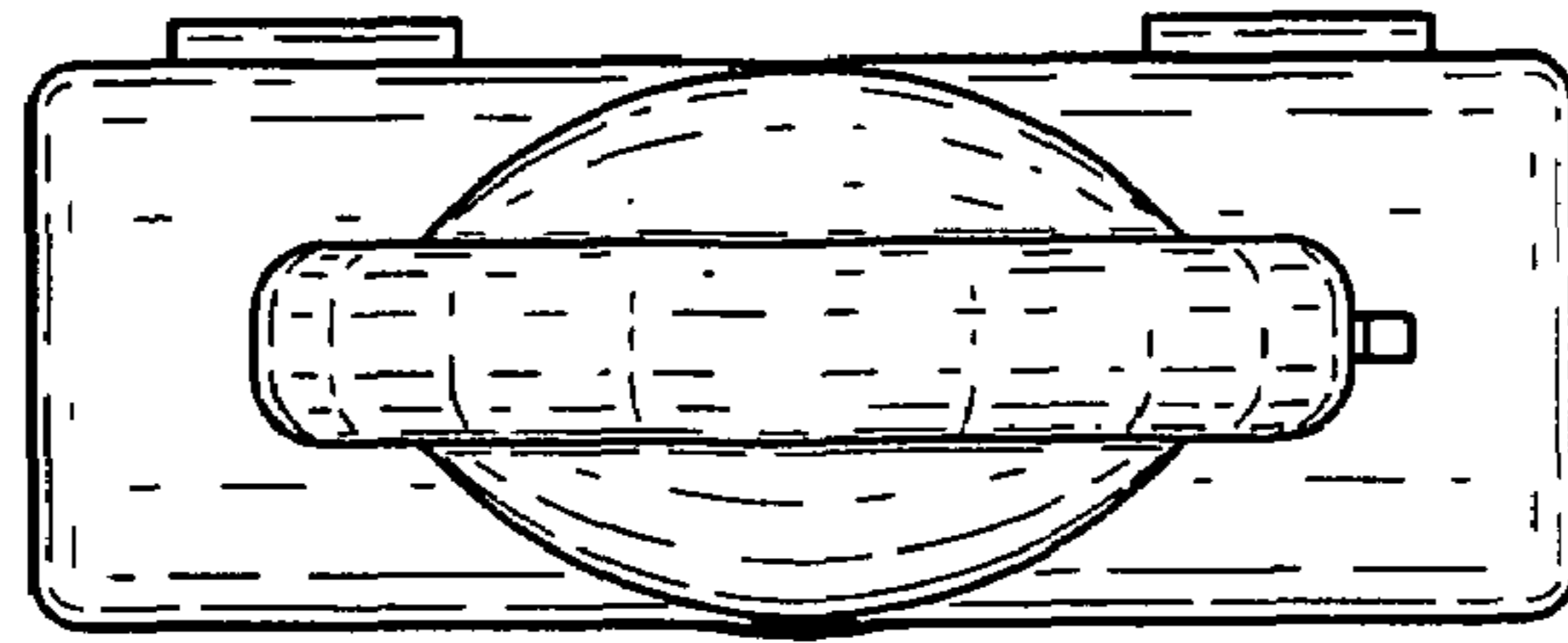

Fig.1

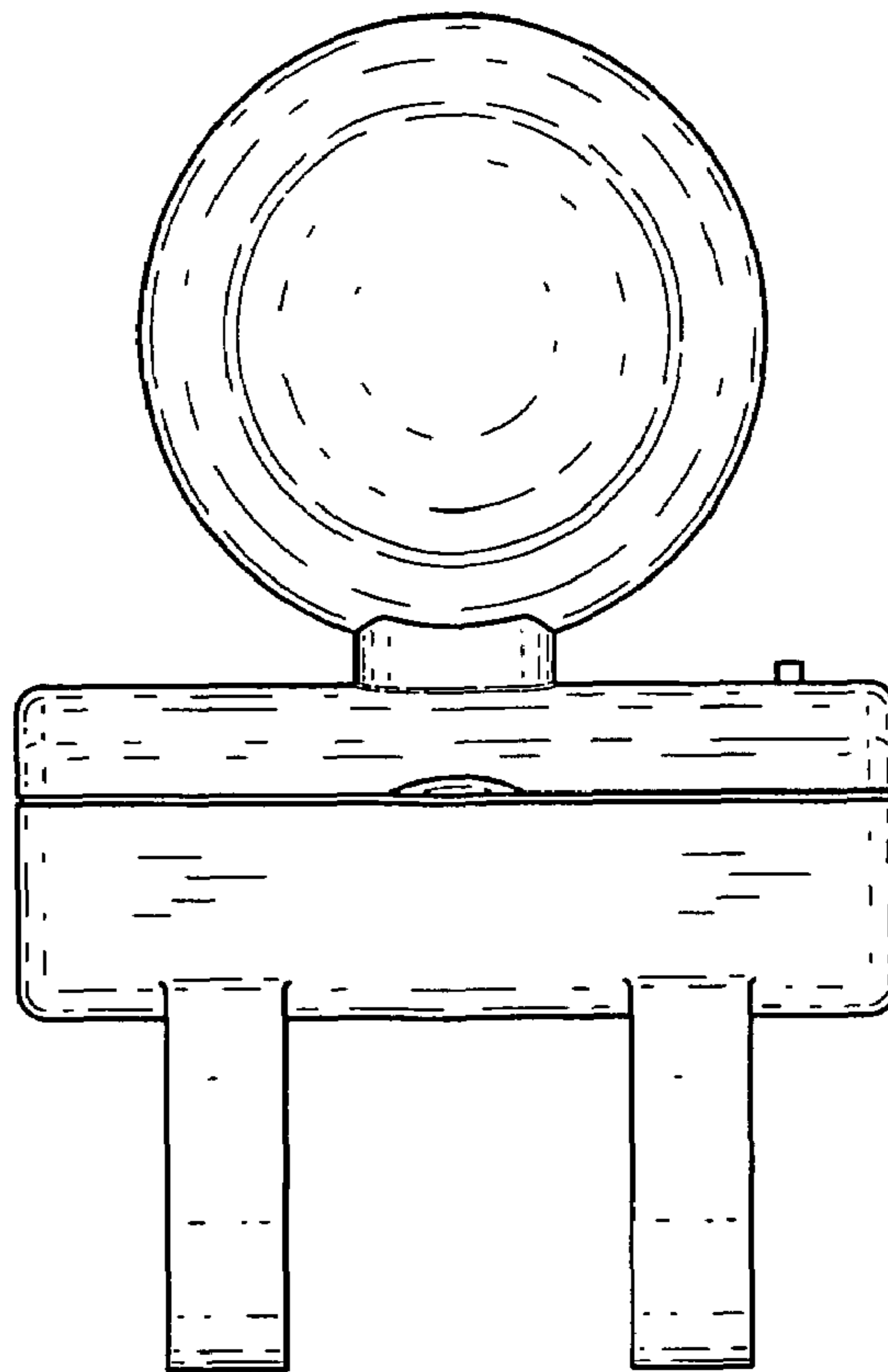

Fig.2

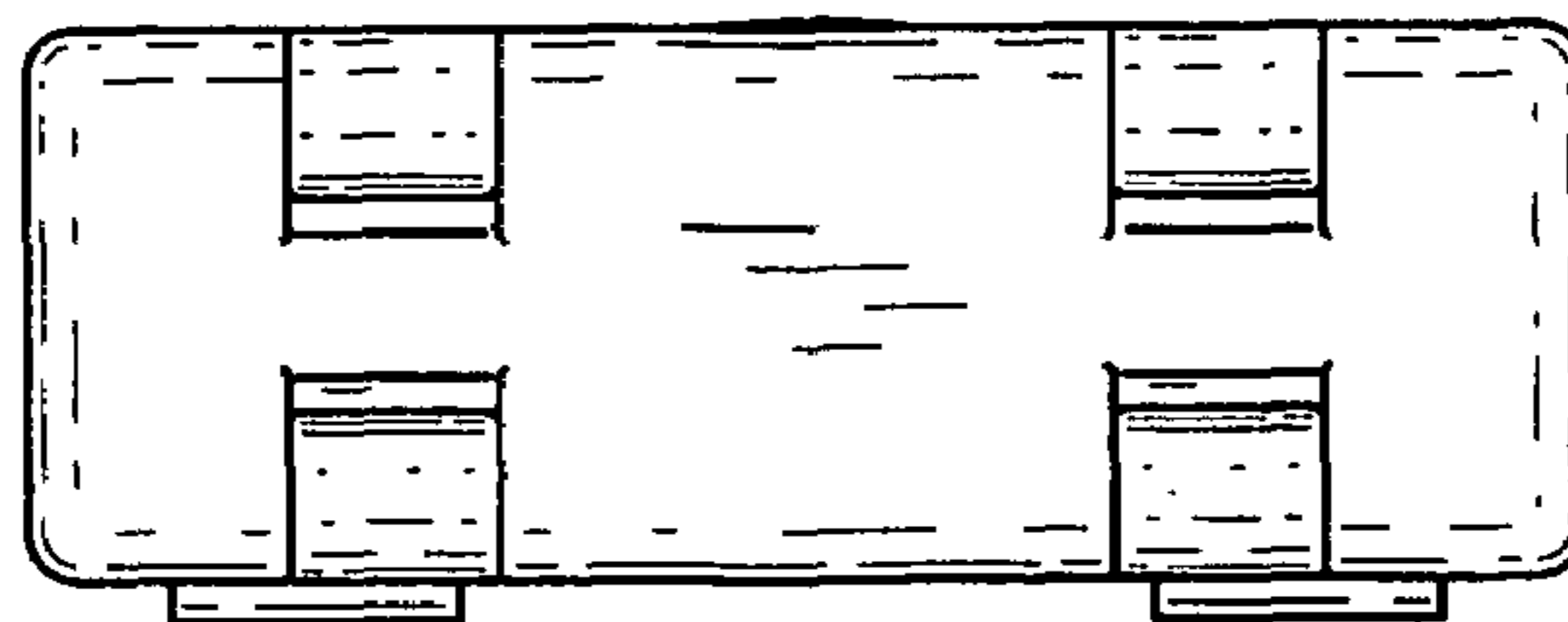

Fig.3

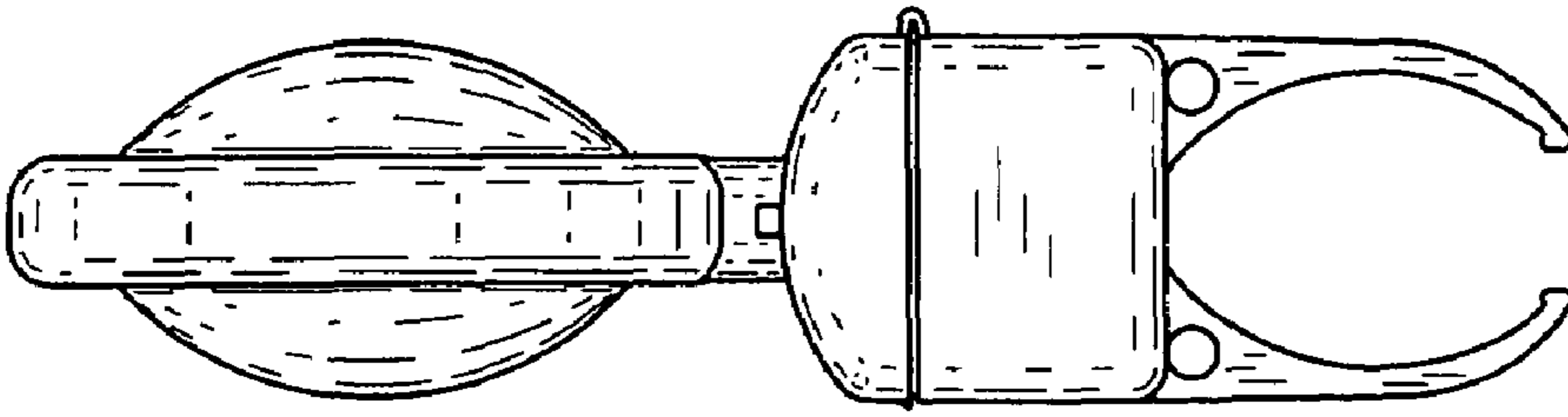

Fig. 4

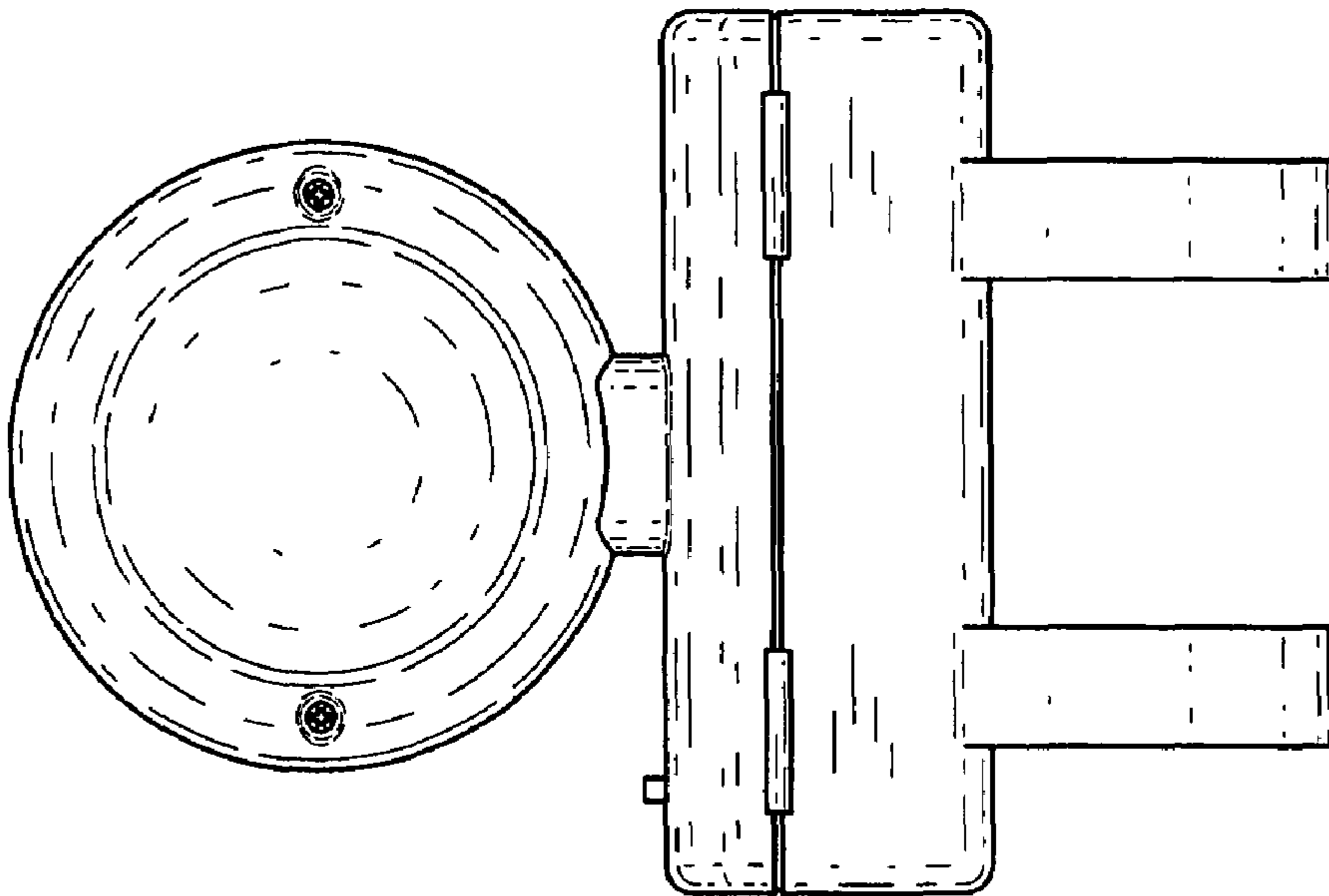

Fig. 5

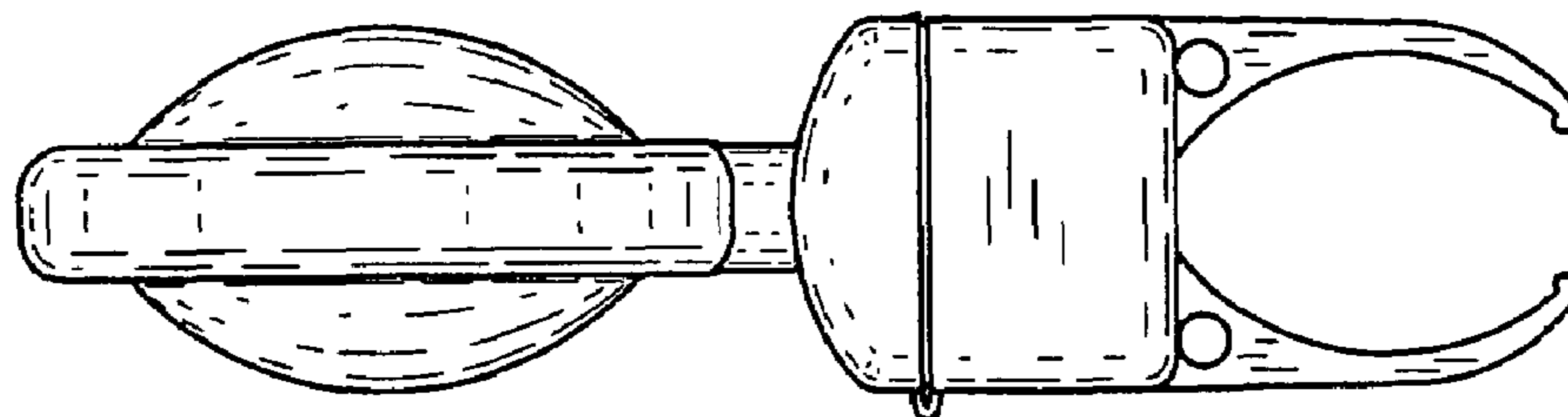

Fig. 6

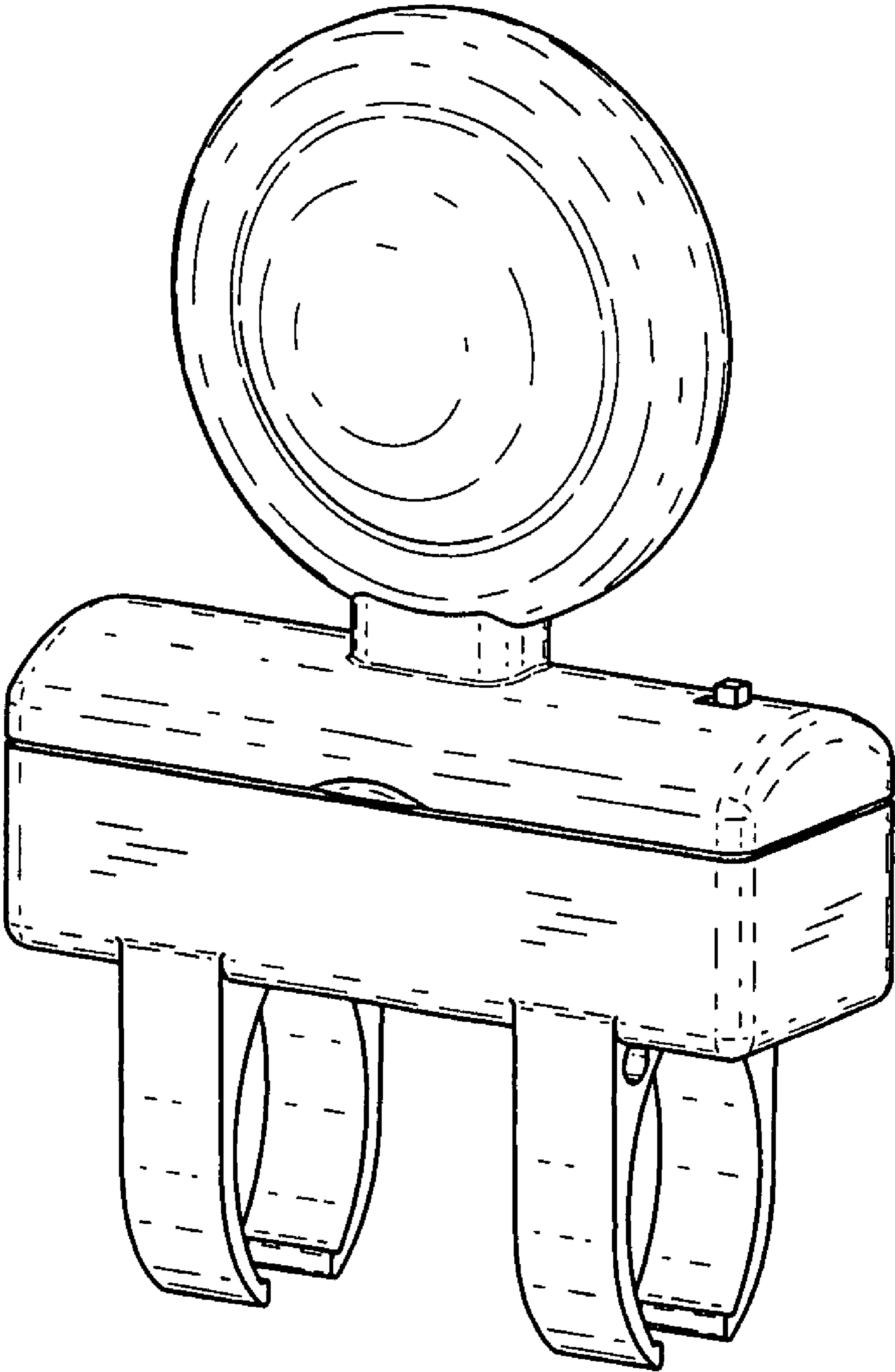

Fig.7