

US00D571416S

(12) **United States Design Patent**  
**Wu**

(10) **Patent No.:** **US D571,416 S**  
(45) **Date of Patent:** **\*\* Jun. 17, 2008**

(54) **FITNESS MACHINE**

(76) Inventor: **Mu-Chuan Wu**, No. 462-7,  
Chung-Shan Rd., Hsi-Kang Chun,  
Hsi-Kang Hsiang, Tainan Hsien (TW)

(\*\*) Term: **14 Years**

(21) Appl. No.: **29/284,815**

(22) Filed: **Sep. 17, 2007**

(51) **LOC (8) Cl.** ..... **21-02**

(52) **U.S. Cl.** ..... **D21/662; D21/686**

(58) **Field of Classification Search** ..... D21/662,  
D21/671, 686, 688, 689; 601/23, 49, 51,  
601/66, 70, 90; 482/51, 145, 146, 112, 113;  
D24/200, 215

See application file for complete search history.

(56) **References Cited**

**U.S. PATENT DOCUMENTS**

5,921,899	A *	7/1999	Rose	.....	482/112
D460,506	S *	7/2002	Tamminga et al.	.....	D21/686
D500,100	S *	12/2004	van der Meer	.....	D21/662
D518,533	S *	4/2006	van der Meer	.....	D21/662
D522,074	S *	5/2006	Dümmel	.....	D21/662
D538,358	S *	3/2007	Glier	.....	D21/662
D548,291	S *	8/2007	Chiang	.....	D21/662
D559,924	S *	1/2008	Wu et al.	.....	D21/661
D561,273	S *	2/2008	Wu et al.	.....	D21/662

2005/0131319 A1\* 6/2005 der Meer ..... 601/49  
2005/0165332 A1\* 7/2005 Talish et al. .... 601/23

\* cited by examiner

*Primary Examiner*—Philip S Hyder

(74) *Attorney, Agent, or Firm*—Alan Kamrath; Kamrath &  
Associates PA

(57) **CLAIM**

The ornamental design for a fitness machine, as shown and described.

**DESCRIPTION**

FIG. 1 is a perspective view of a fitness machine, showing my new design;

FIG. 2 is a front view thereof;

FIG. 3 is a rear view thereof;

FIG. 4 is a left view thereof;

FIG. 5 is a right view thereof;

FIG. 6 is a top view thereof;

FIG. 7 is a bottom view thereof; and,

FIG. 8 is a perspective referenced view of the fitness machine in FIG. 1, wherein the broken lines are shown for illustrative purposes only and form no part of the claimed design.

**1 Claim, 8 Drawing Sheets**

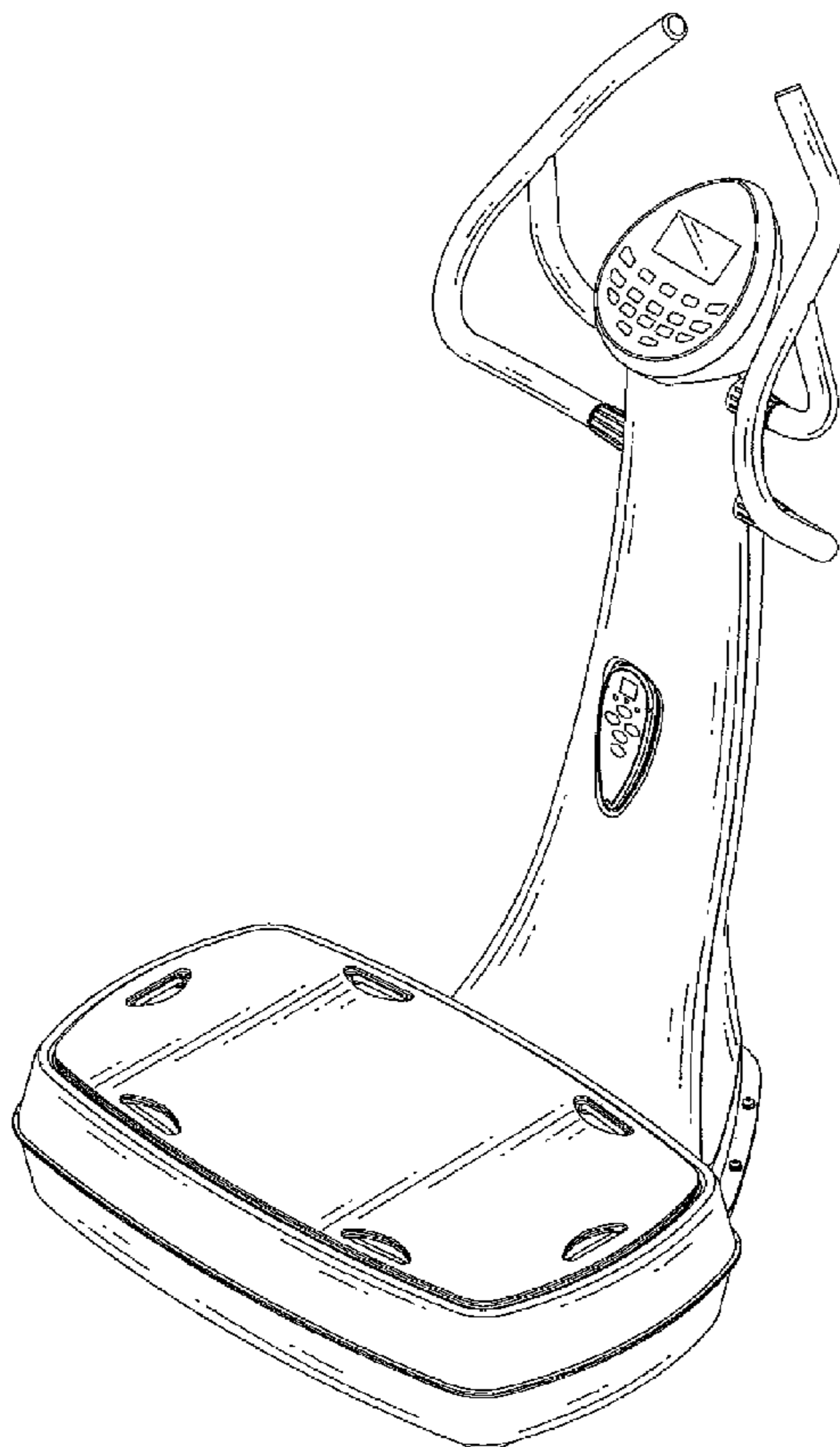

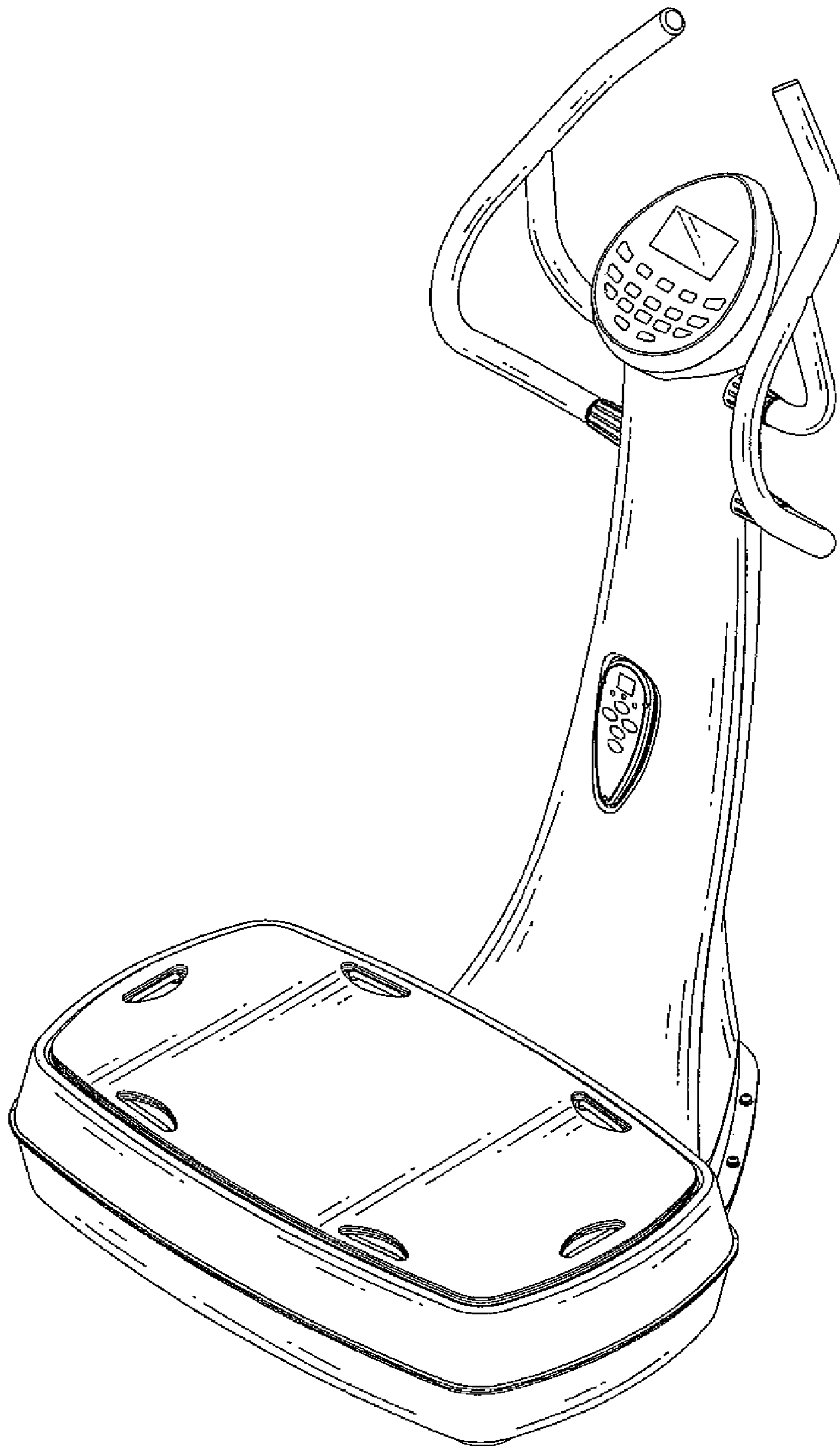

FIG.1

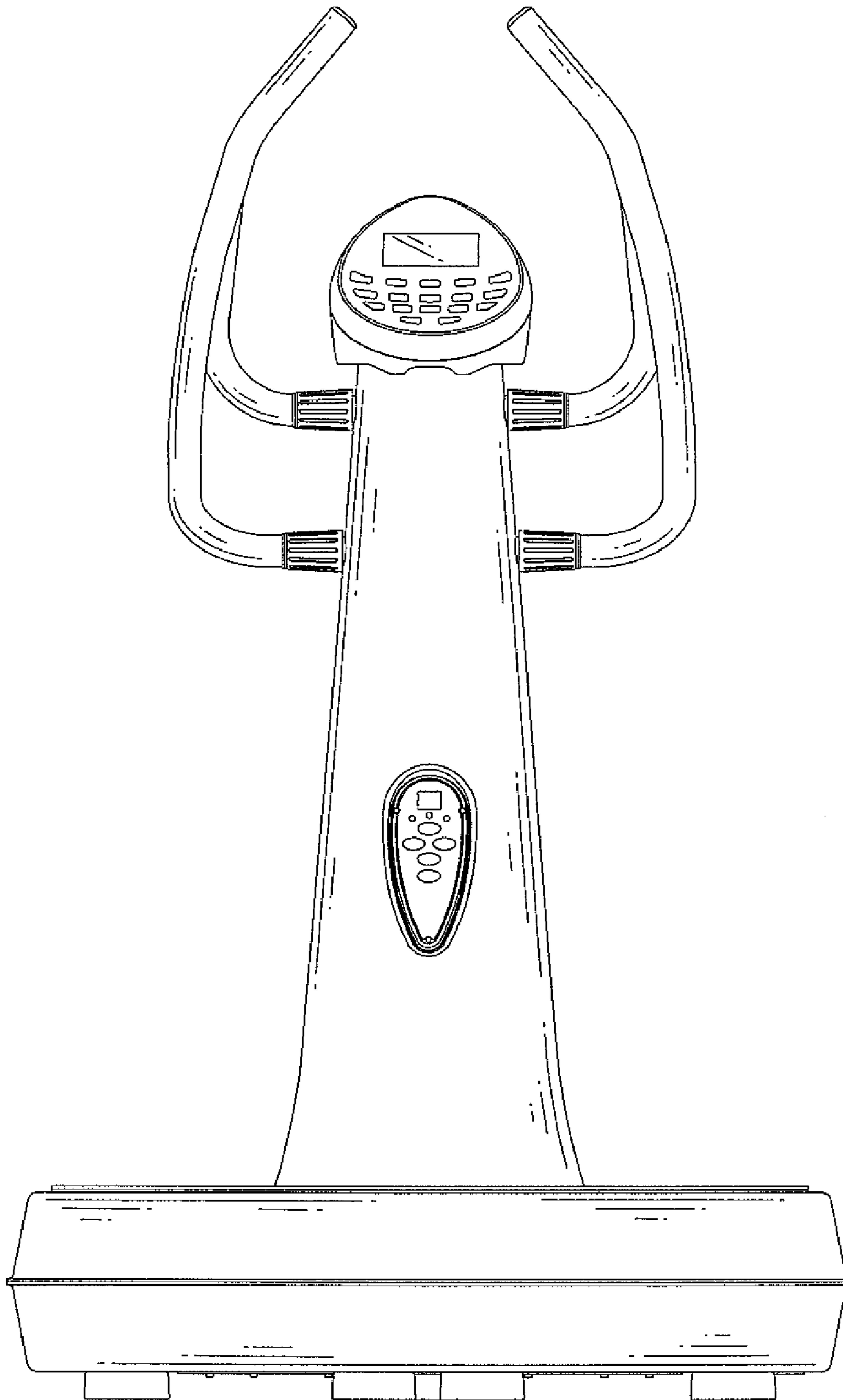

FIG.2

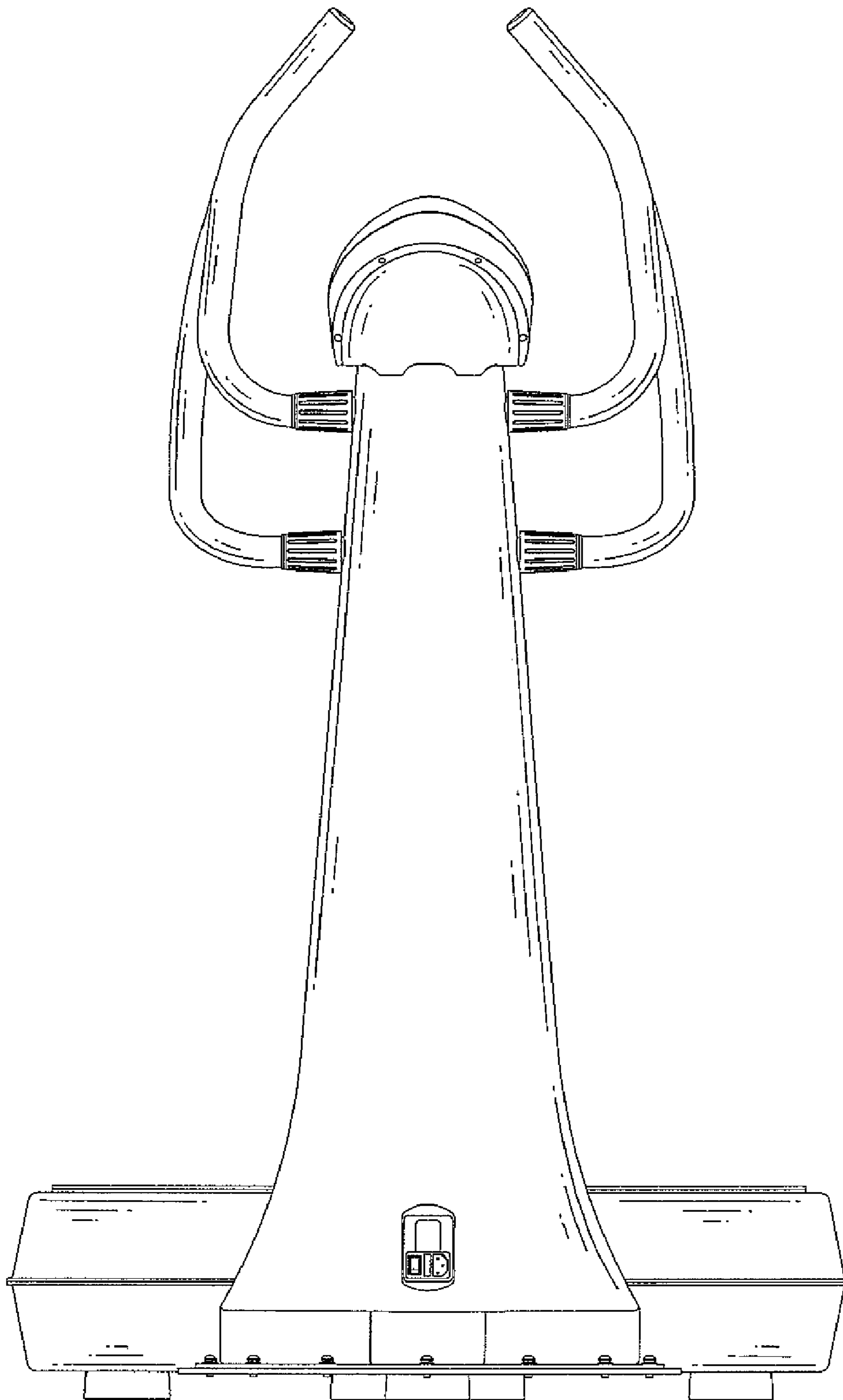

FIG.3



FIG.4

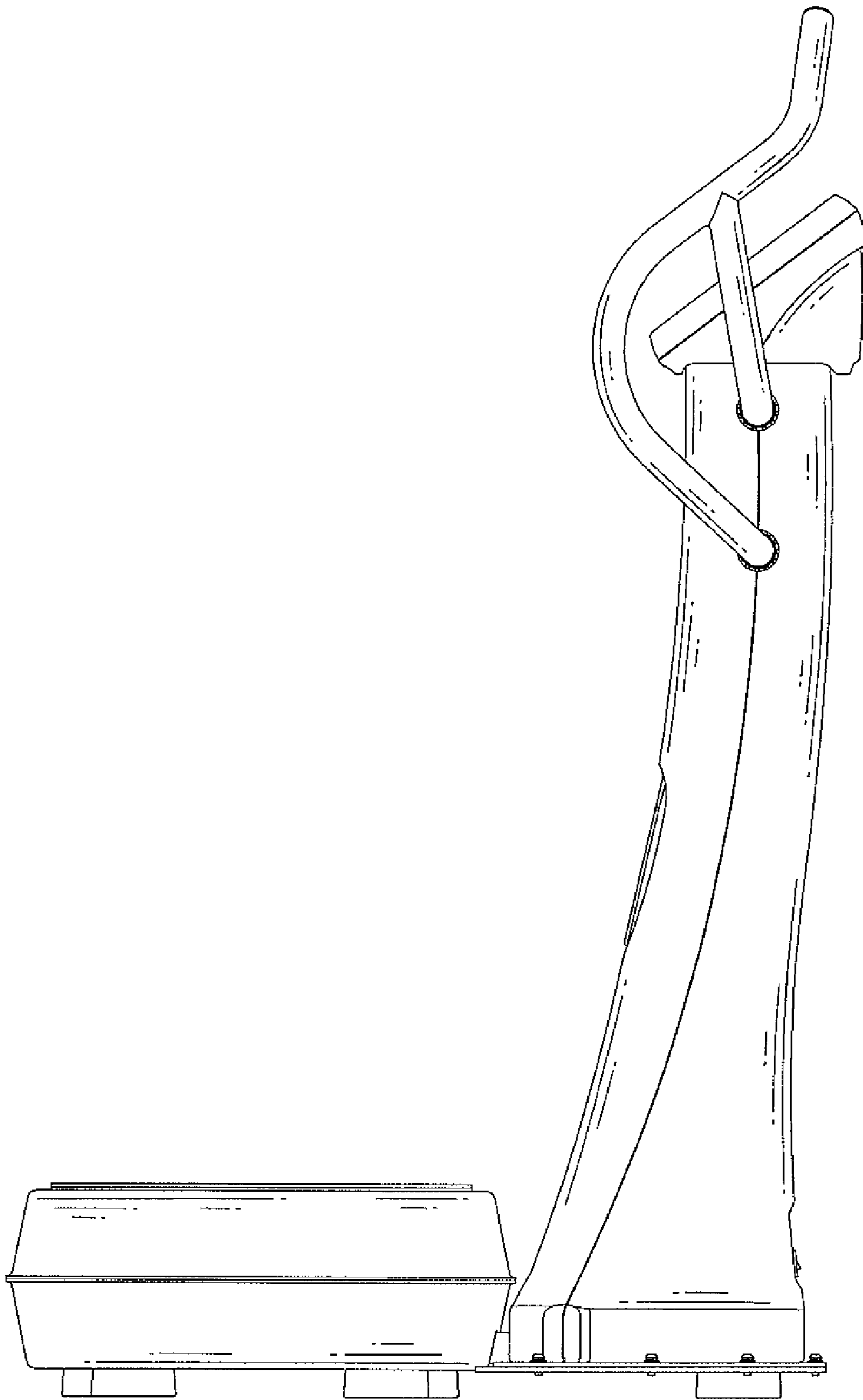

FIG. 5

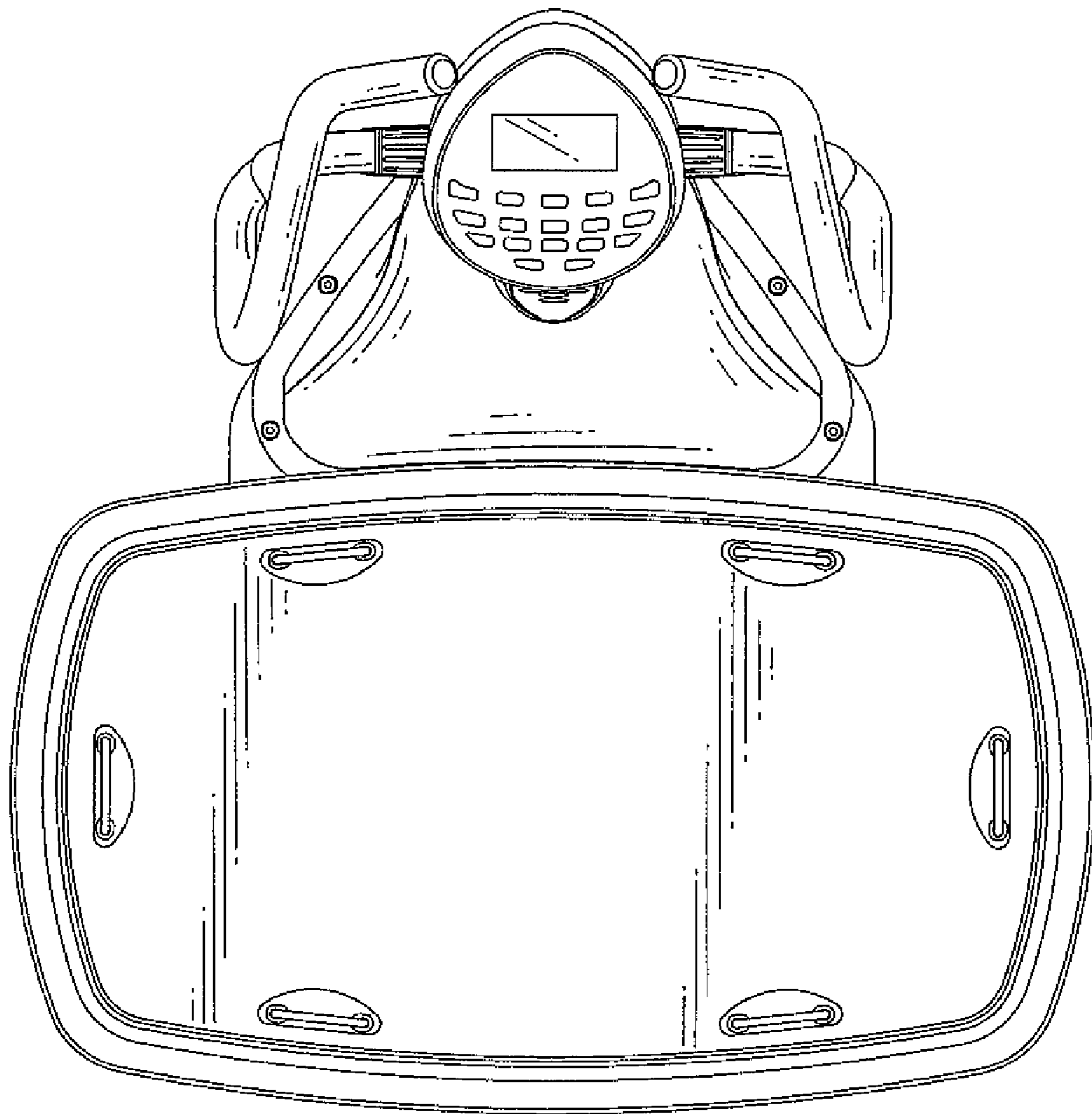

FIG.6

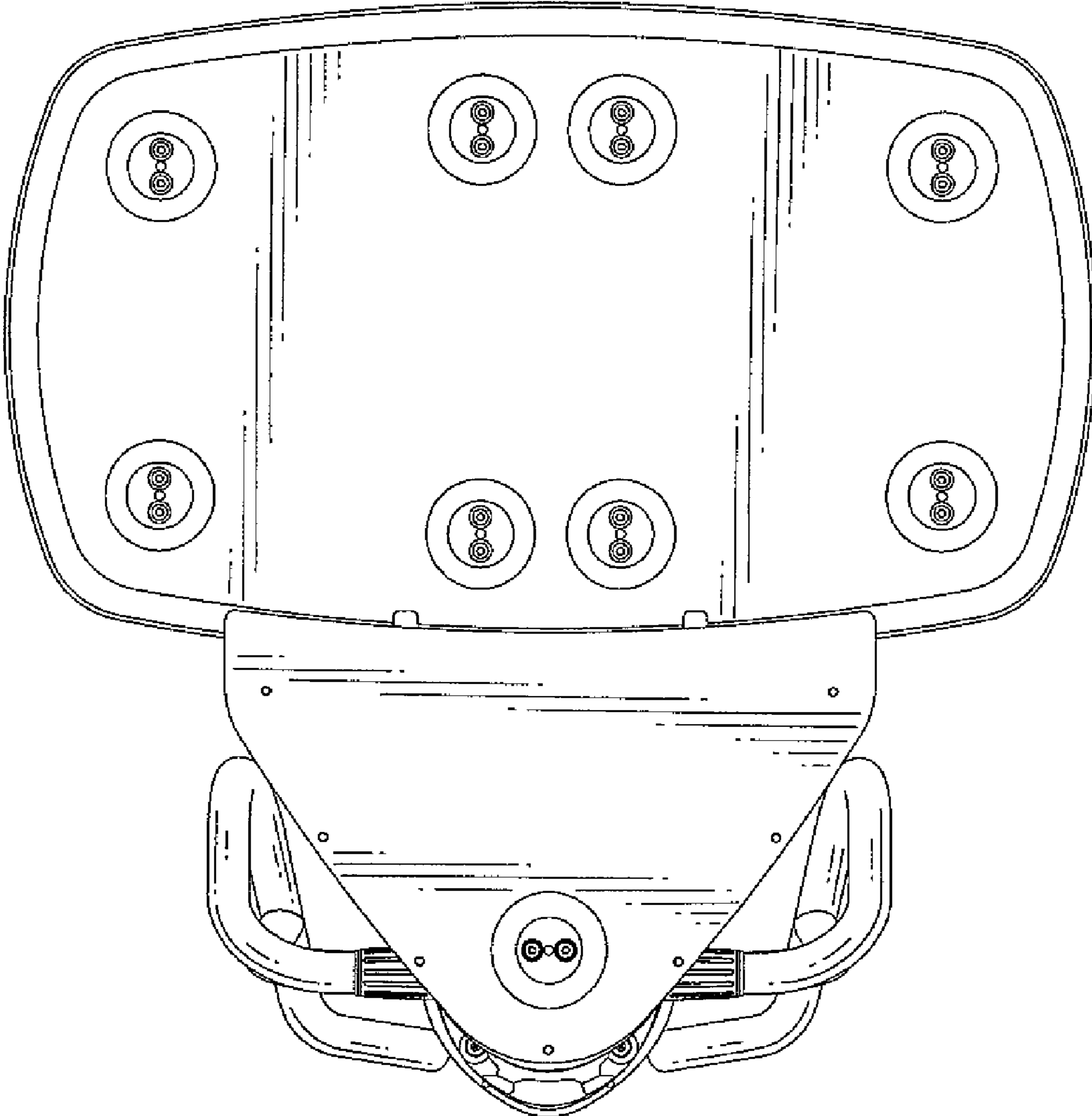

FIG.7



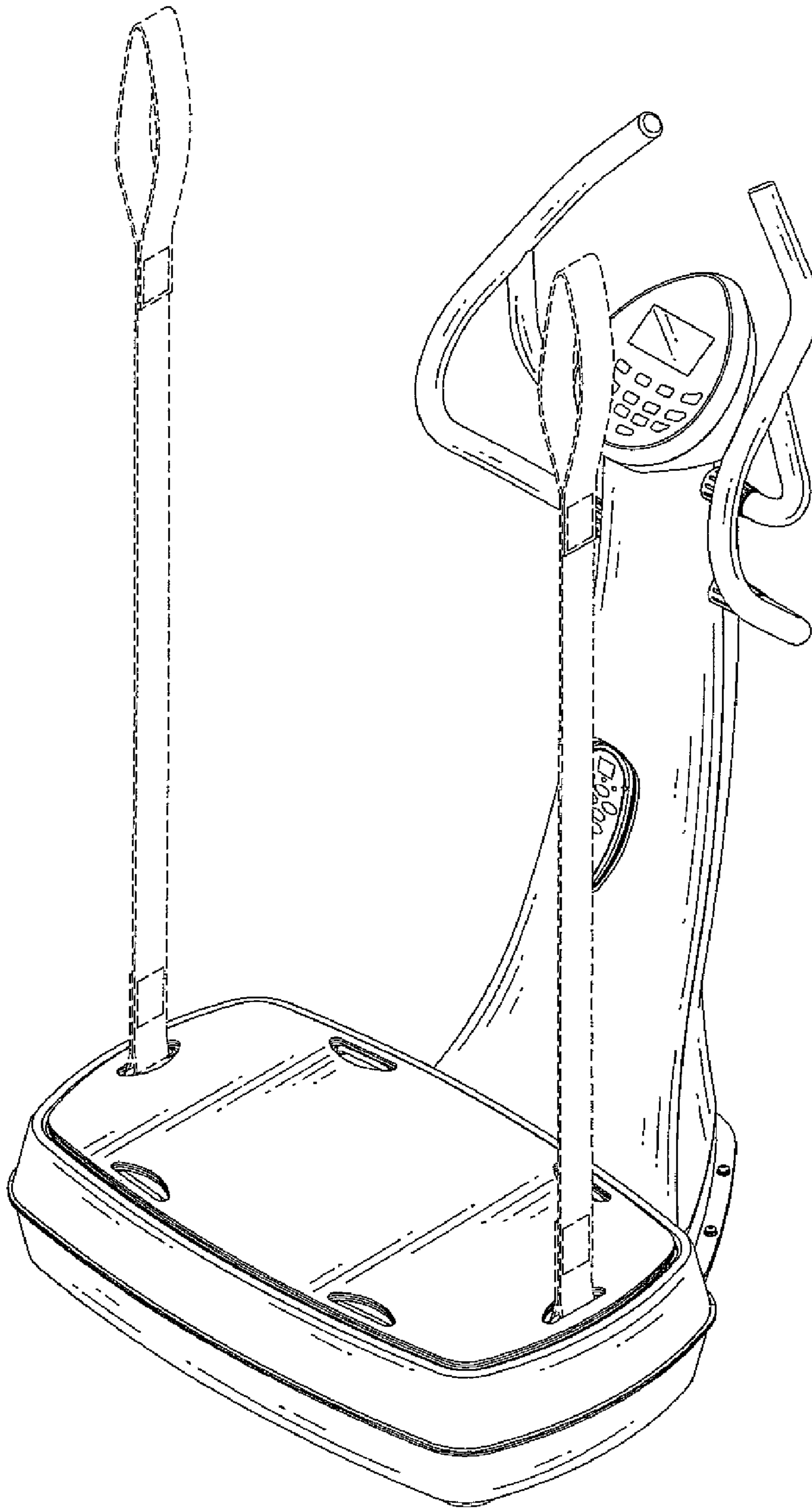

FIG.8