



US00D571352S

(12) **United States Design Patent**
Yamamoto et al.

(10) **Patent No.:** **US D571,352 S**
(45) **Date of Patent:** **** Jun. 17, 2008**

(54) **AMPLIFIER FOR VEHICLE**

D449,288 S * 10/2001 Sogabe D14/188
D548,722 S * 8/2007 Suzuki D14/188

(75) Inventors: **Hiroshi Yamamoto**, Yokohama (JP);
Shinichi Ohtsuki, Chigasaki (JP)

* cited by examiner

(73) Assignee: **Victor Company of Japan, Limited**,
Yokohama-shi (JP)

Primary Examiner—Stella M. Reid
Assistant Examiner—Keli L Acker
(74) *Attorney, Agent, or Firm*—The Nath Law Group; Jerald
L. Meyer; Derek Richmond

(**) Term: **14 Years**

(21) Appl. No.: **29/274,923**

(57) **CLAIM**

(22) Filed: **Jun. 7, 2007**

The ornamental design for an amplifier for vehicle, as shown
and described.

(30) **Foreign Application Priority Data**

DESCRIPTION

Dec. 11, 2006 (JP) D2006-034025

FIG. 1 is a perspective view of an amplifier for vehicle;

(51) **LOC (8) Cl.** **14-03**

FIG. 2 is a front view thereof;

(52) **U.S. Cl.** **D14/188**

FIG. 3 is a rear view thereof;

(58) **Field of Classification Search** D14/168,
D14/169, 179, 188, 194–198, 204, 210, 212,
D14/214, 257, 265, 299; 330/1 R, 3, 4, 250;
381/86, 120; 455/344–351

FIG. 4 is a left side view thereof;

FIG. 5 is a right side view thereof;

FIG. 6 is a top plan view thereof;

FIG. 7 is a bottom plan view thereof; and,

See application file for complete search history.

FIG. 8 is a perspective view thereof showing the article with
its control panel cover attached.

(56) **References Cited**

The broken lines showing on the drawing disclosure are for
illustrative purposes only and form no part of the claimed
design.

U.S. PATENT DOCUMENTS

D244,616 S * 6/1977 Sizer D14/197
D322,069 S * 12/1991 Seror D14/188
D343,395 S * 1/1994 Kakizaki D14/188
D343,838 S * 2/1994 Frank et al. D14/198
D416,558 S * 11/1999 Harrington D14/188

1 Claim, 6 Drawing Sheets

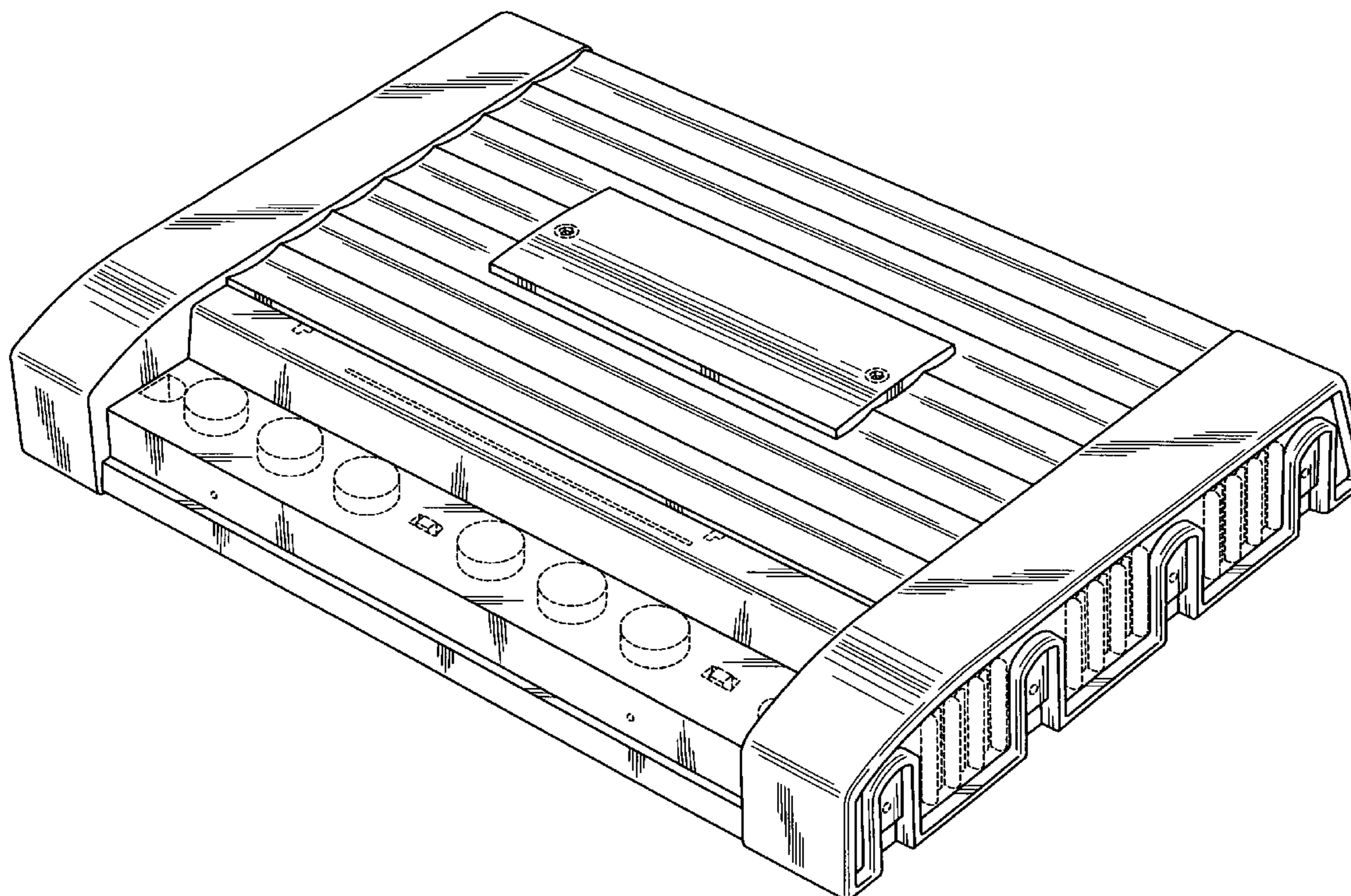

Fig.1

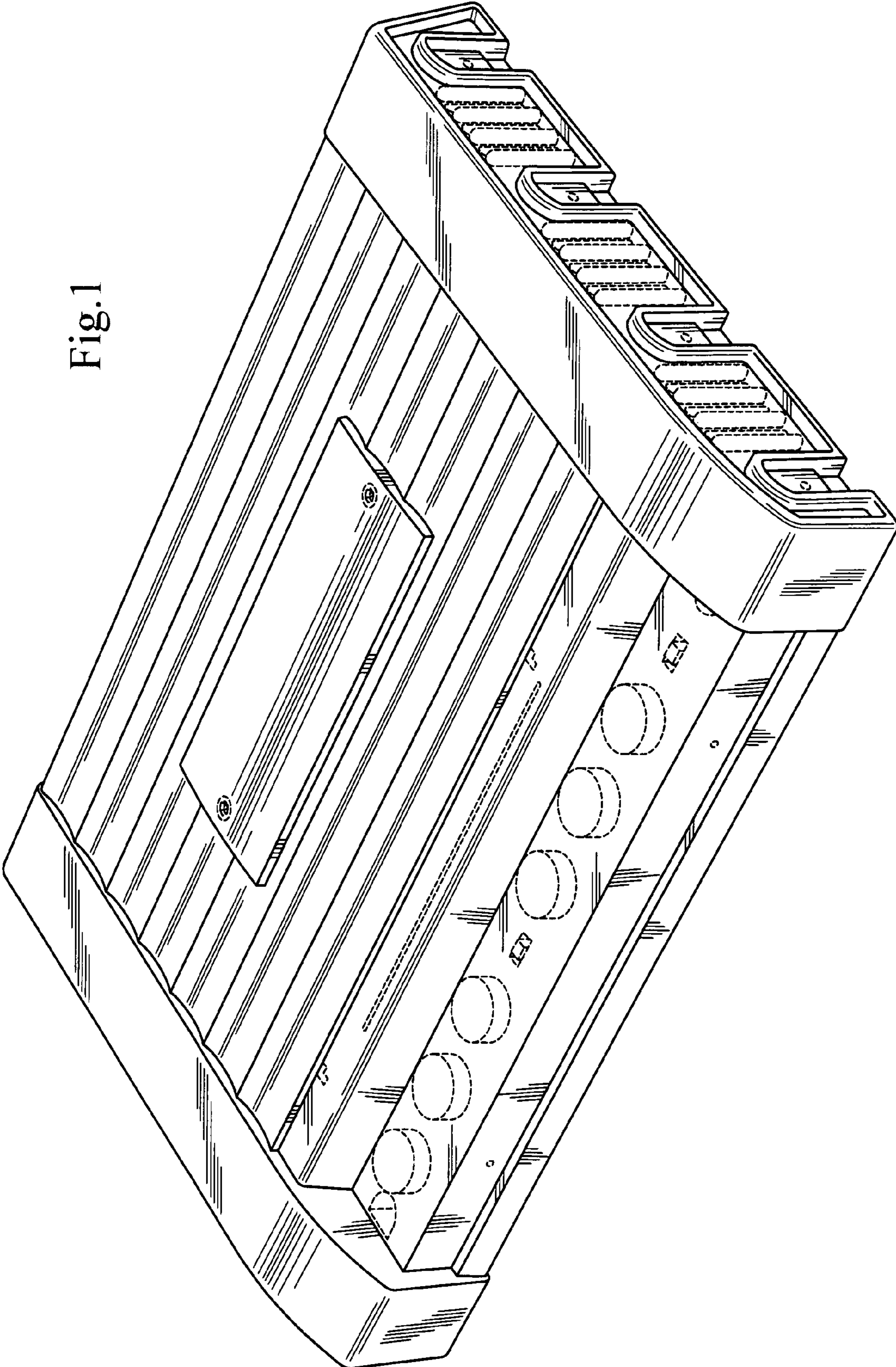

Fig.2

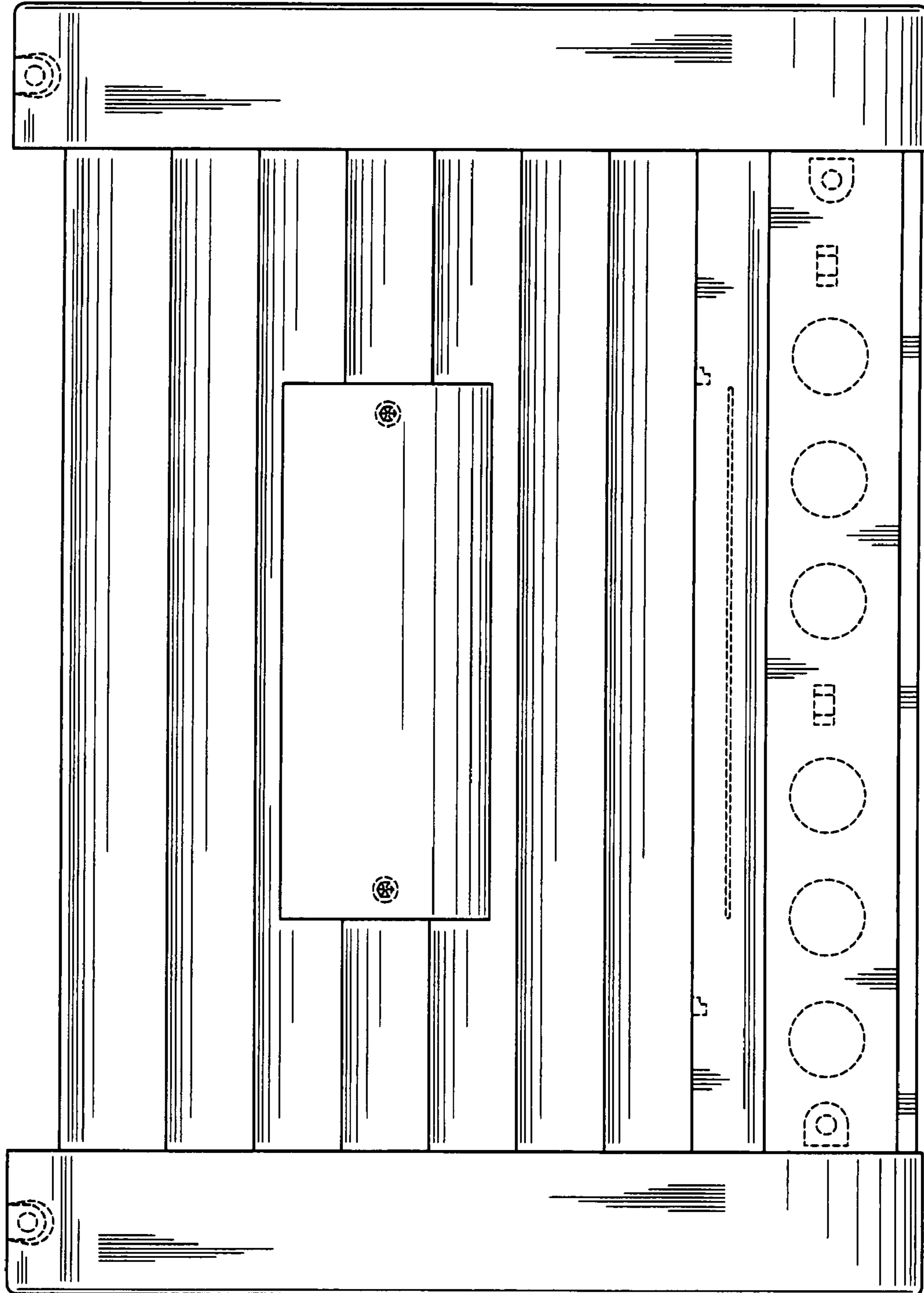

Fig.3

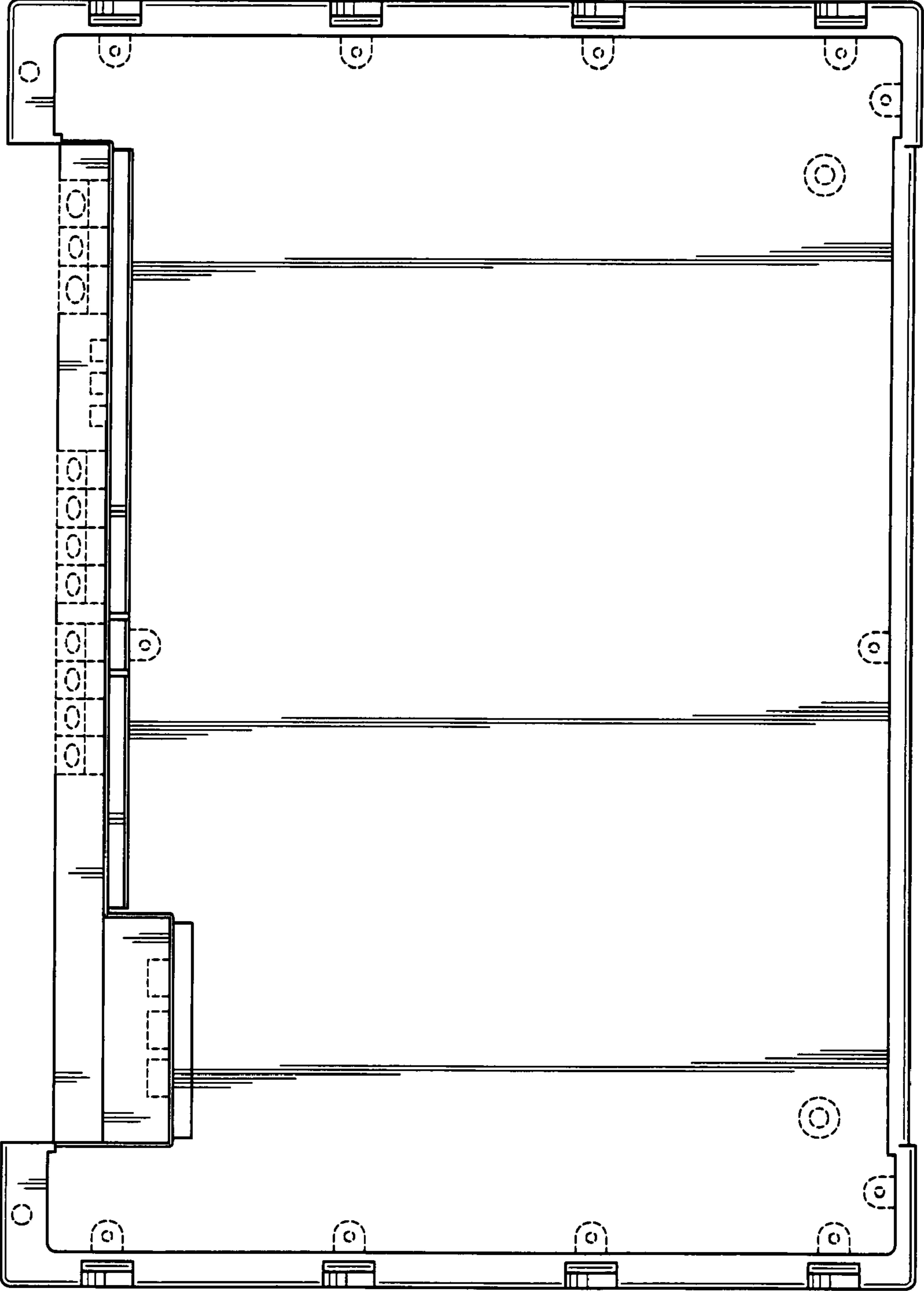

Fig.4

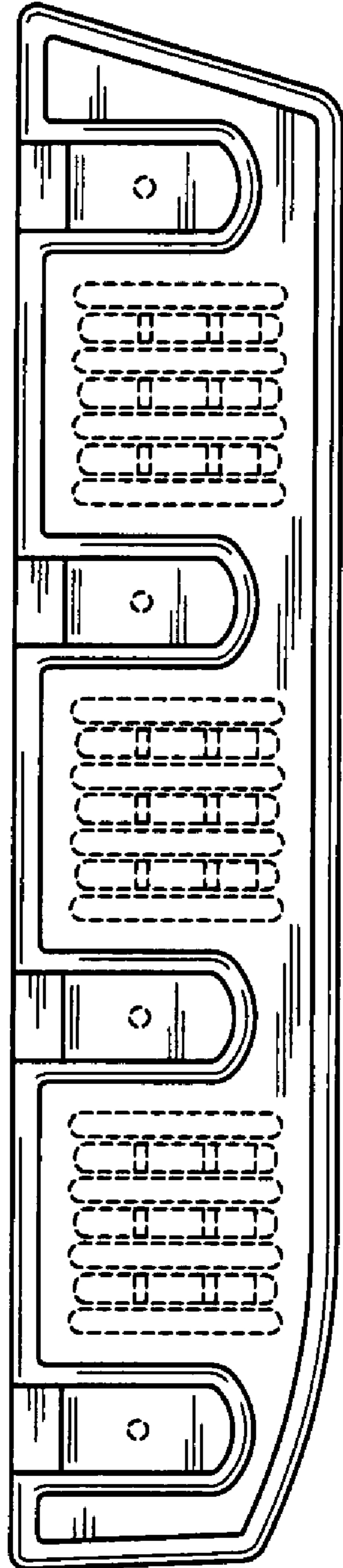

Fig.5

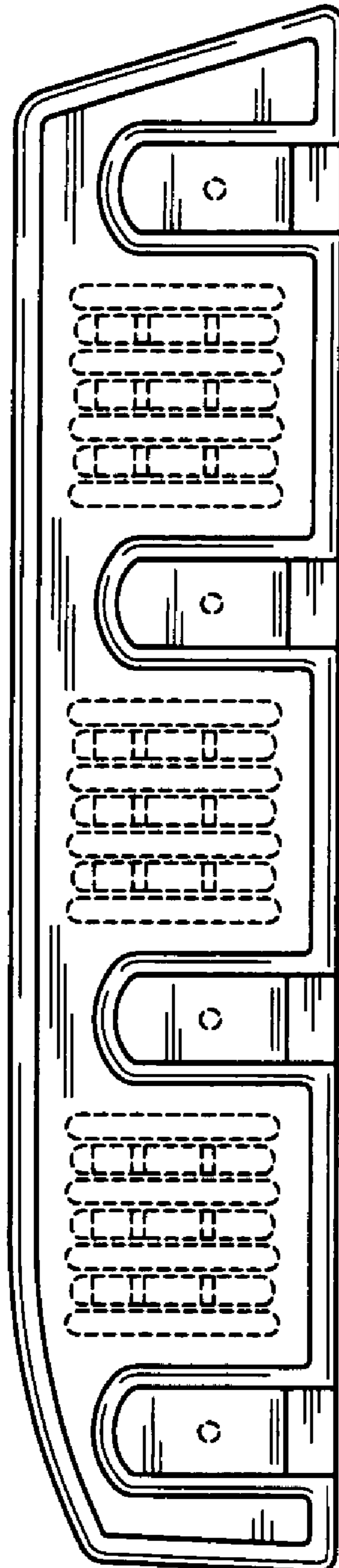

Fig.6

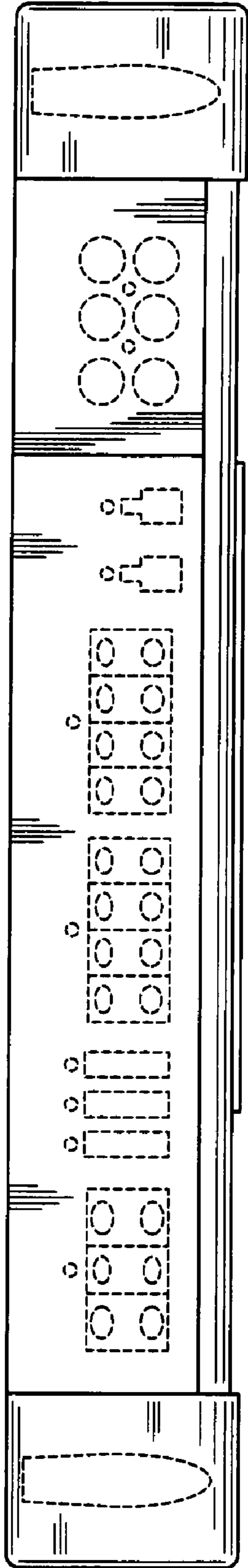

Fig.7

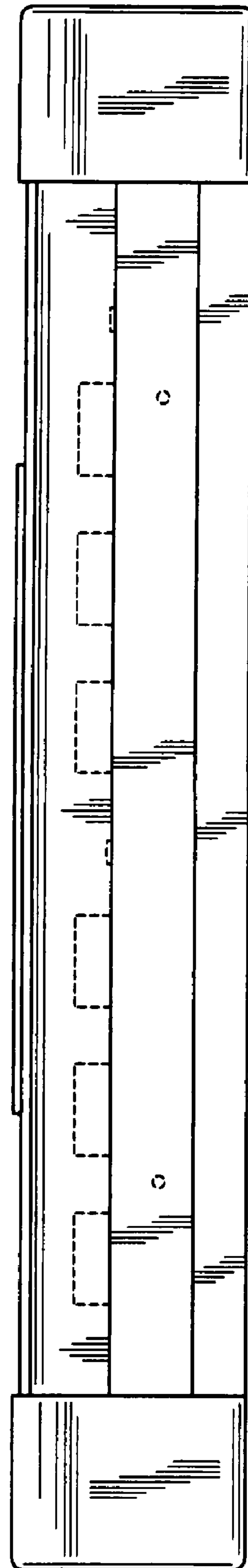

Fig.8

