



US00D571197S

(12) **United States Design Patent**
Sanfilippo et al.

(10) **Patent No.:** **US D571,197 S**
(45) **Date of Patent:** **** Jun. 17, 2008**

(54) **FLEXIBLE CONTAINER AND LID**

(75) Inventors: **John E. Sanfilippo**, Barrington Hills, IL (US); **James J. Sanfilippo**, Barrington Hills, IL (US); **Jeanne M. Skaggs**, Arlington Heights, IL (US); **Roy D. Speer**, Barrington, IL (US)

(73) Assignee: **Clear Lam Packaging, Inc.**, Elk Grove Village, IL (US)

(**) Term: **14 Years**

(21) Appl. No.: **29/295,565**

(22) Filed: **Oct. 1, 2007**

(51) **LOC (8) Cl.** **09-03**

(52) **U.S. Cl.** **D9/420; D9/423**

(58) **Field of Classification Search** D9/420-423, D9/426, 432; D3/257; D7/629; D28/76, D28/77; D34/11; 222/556; 229/225-234, 229/125.09; 206/37, 540, 564, 566; 220/254.3, 220/259.1, 713, 819, 378, 835; 264/250
See application file for complete search history.

(56) **References Cited**

U.S. PATENT DOCUMENTS

D266,049	S	*	9/1982	Conti	D7/602
5,065,887	A	*	11/1991	Schuh et al.	220/835
5,611,452	A	*	3/1997	Bonora et al.	220/378
D386,001	S	*	11/1997	Saffran	D9/573
D394,606	S	*	5/1998	Zorn et al.	D9/432
D463,276	S	*	9/2002	Piscopo et al.	D9/420
D464,884	S	*	10/2002	Sumpmann et al.	D9/432
D471,804	S	*	3/2003	Staples	D9/423
D473,461	S	*	4/2003	Joubert	D9/423
D545,186	S	*	6/2007	Liebe et al.	D9/420
D552,468	S	*	10/2007	Seum et al.	D9/420
2006/0076352	A1	*	4/2006	Peterson et al.	220/254.3

* cited by examiner

Primary Examiner—Daniel D Bui

Assistant Examiner—Thomas J Johannes

(74) *Attorney, Agent, or Firm*—Cardinal Law Group

(57) **CLAIM**

We claim the ornamental design for a flexible container and lid, as shown and described.

DESCRIPTION

FIG. 1 is a perspective view of a flexible container and lid;
 FIG. 2 is a front side view of the flexible container and lid;
 FIG. 3 is a back side view of the flexible container and lid;
 FIG. 4 is a right side view of the flexible container and lid;
 FIG. 5 is a left side view of the flexible container and lid;
 FIG. 6 is a top view of the flexible container and lid;
 FIG. 7 is a bottom view of the flexible container and lid;
 FIG. 8 is a perspective view of the flexible container and lid with the lid in an open position;
 FIG. 9 is a front side view of the flexible container and lid with the lid in an open position;
 FIG. 10 is a back side view of the flexible container and lid with the lid in an open position;
 FIG. 11 is a right side view of the flexible container and lid with the lid in an open position;
 FIG. 12 is a left side view of the flexible container and lid with the lid in an open position;
 FIG. 13 is a top view of the flexible container and lid with the lid in an open position; and,
 FIG. 14 is a bottom view of the flexible container and lid with the lid in an open position.

The broken lines in the figures showing a peel tab are for illustrative purposes only and form no part of the claimed design.

1 Claim, 8 Drawing Sheets

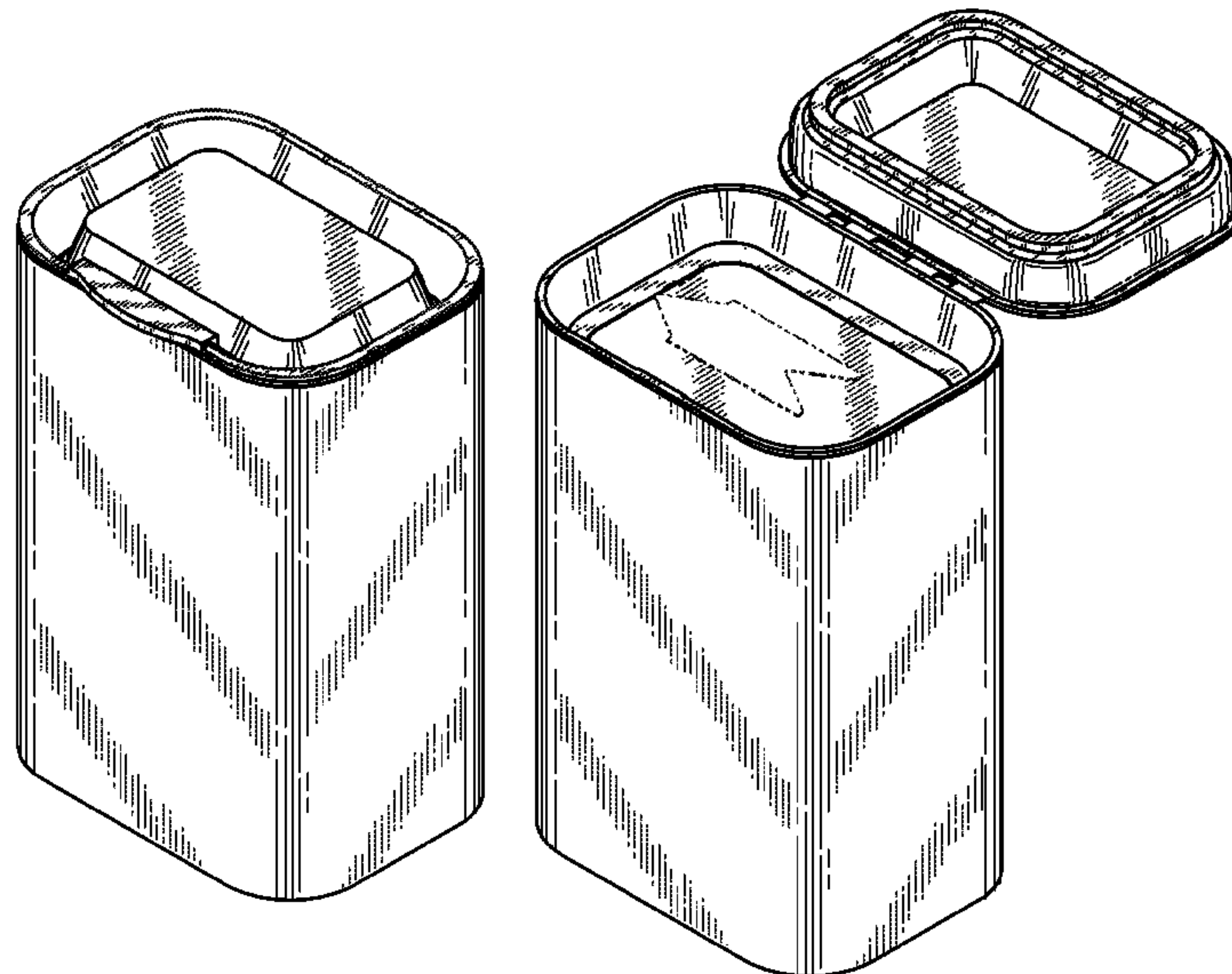

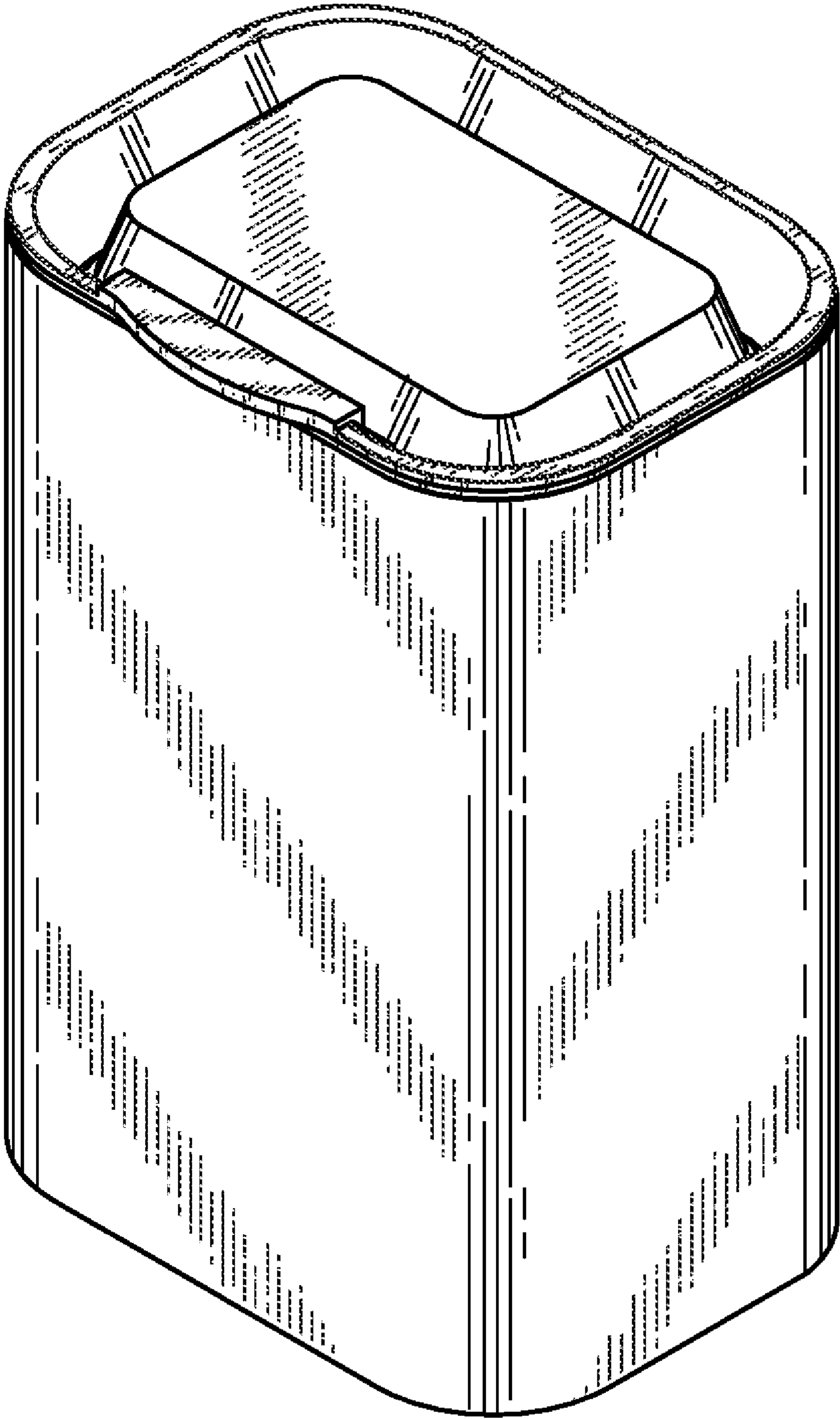

FIG. 1

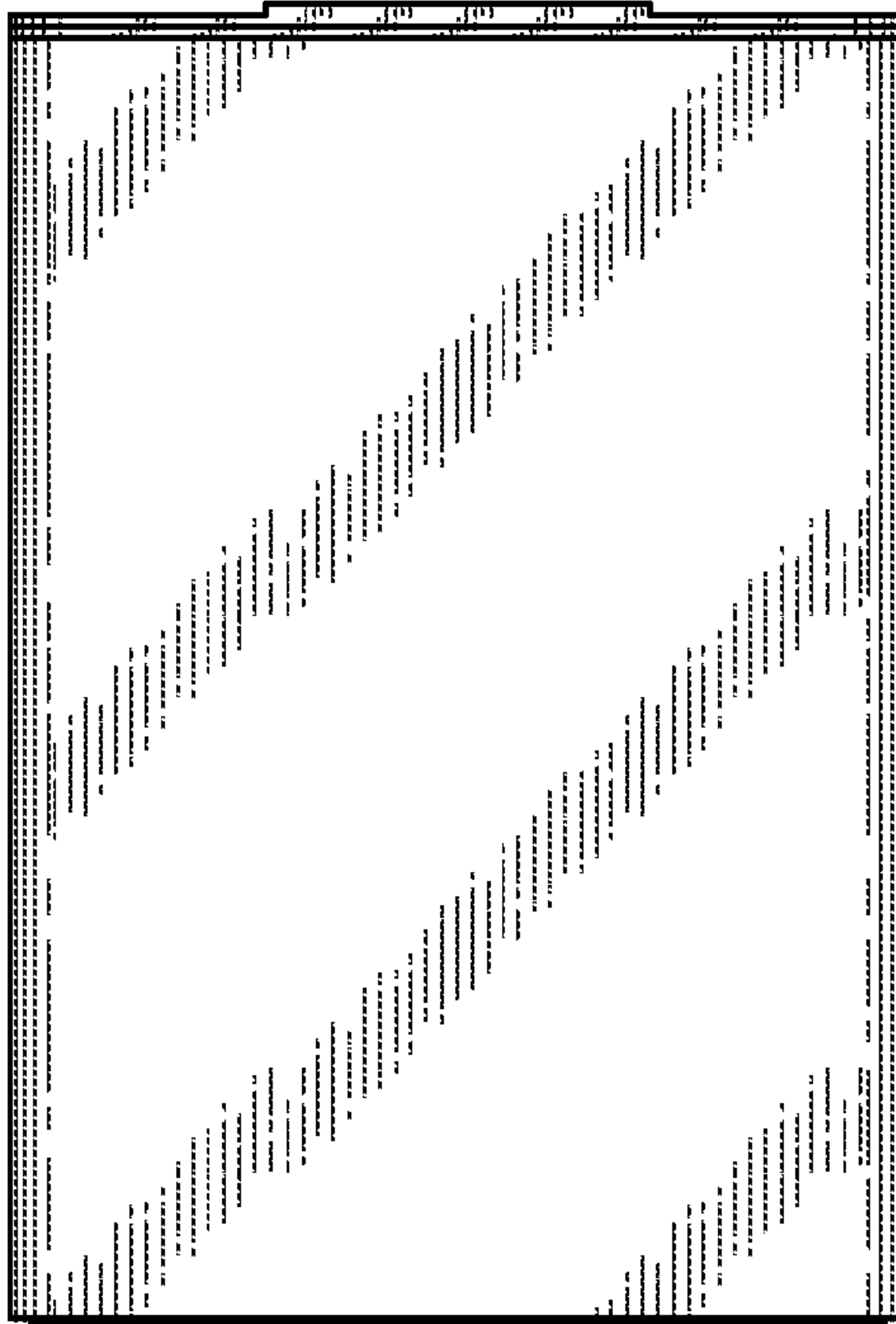

FIG. 2

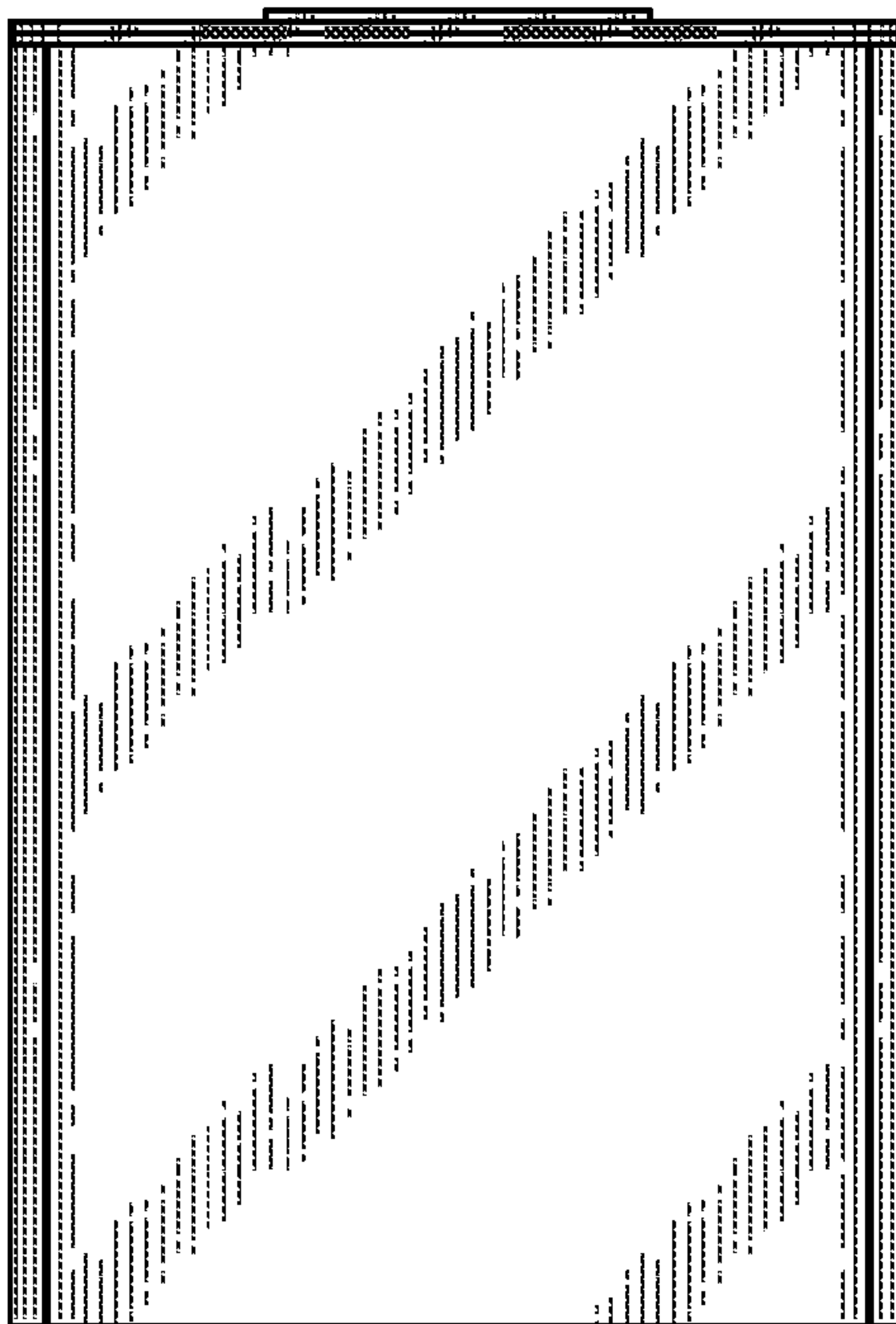

FIG. 3

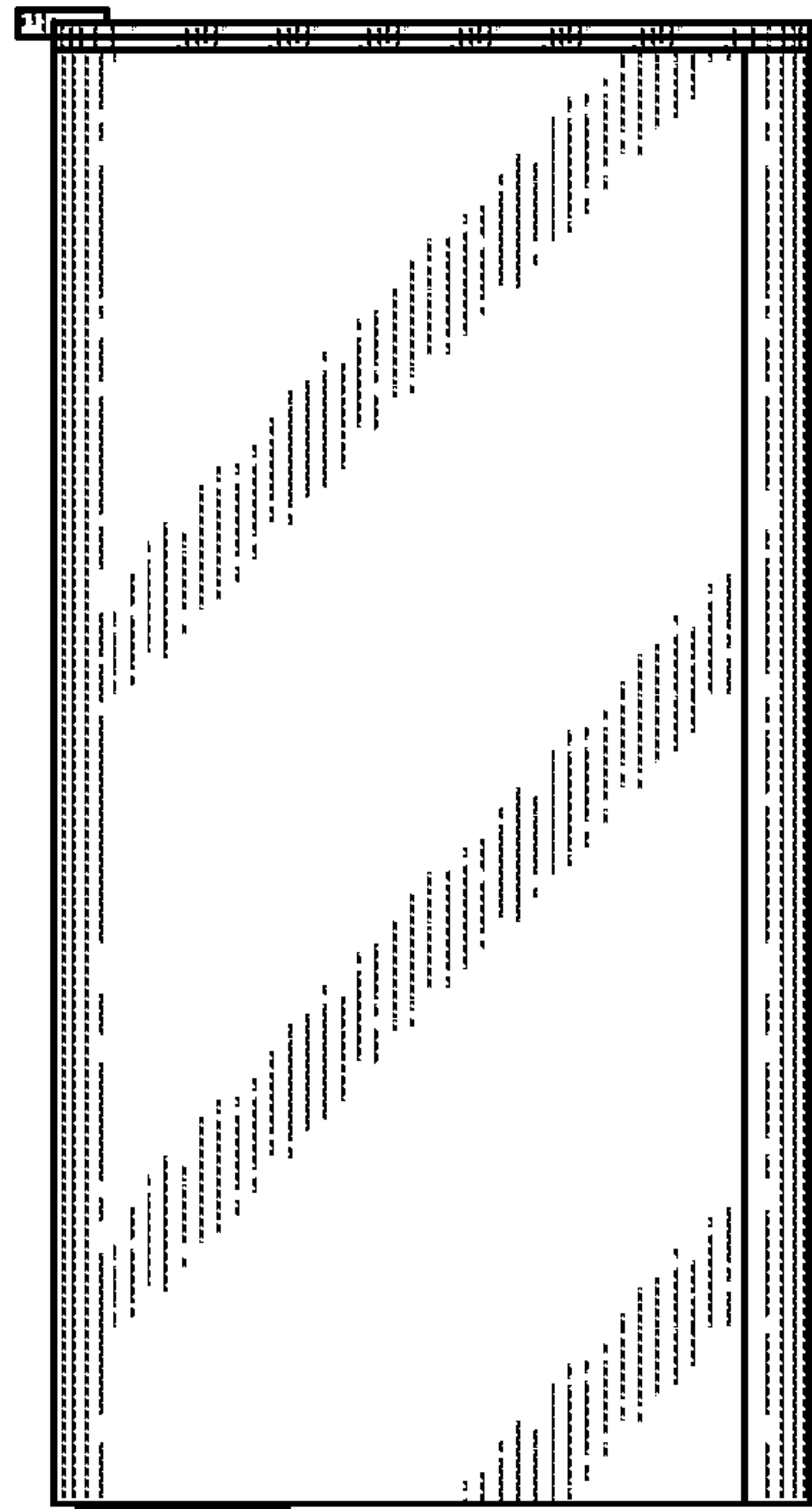

FIG. 4

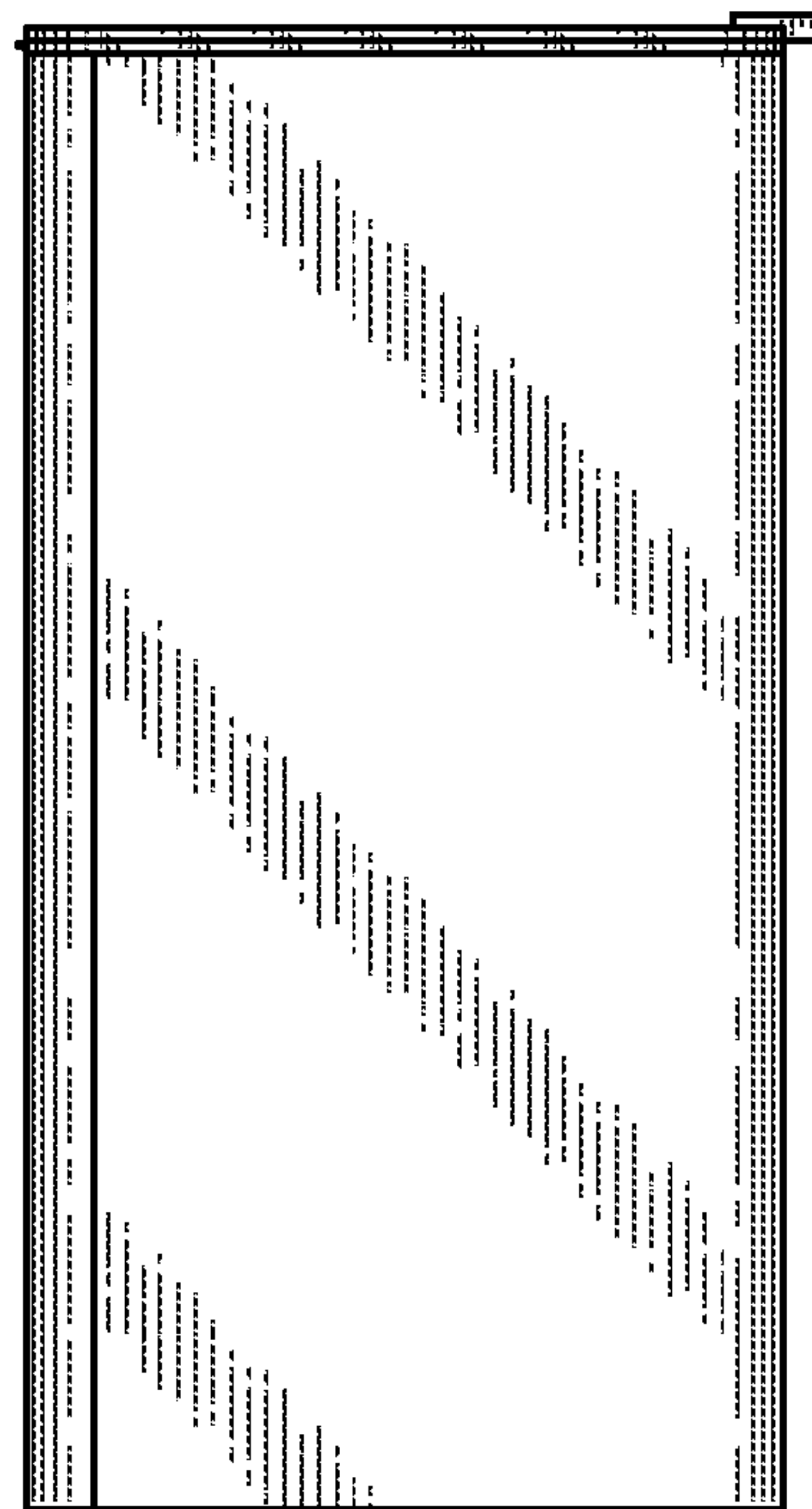

FIG. 5

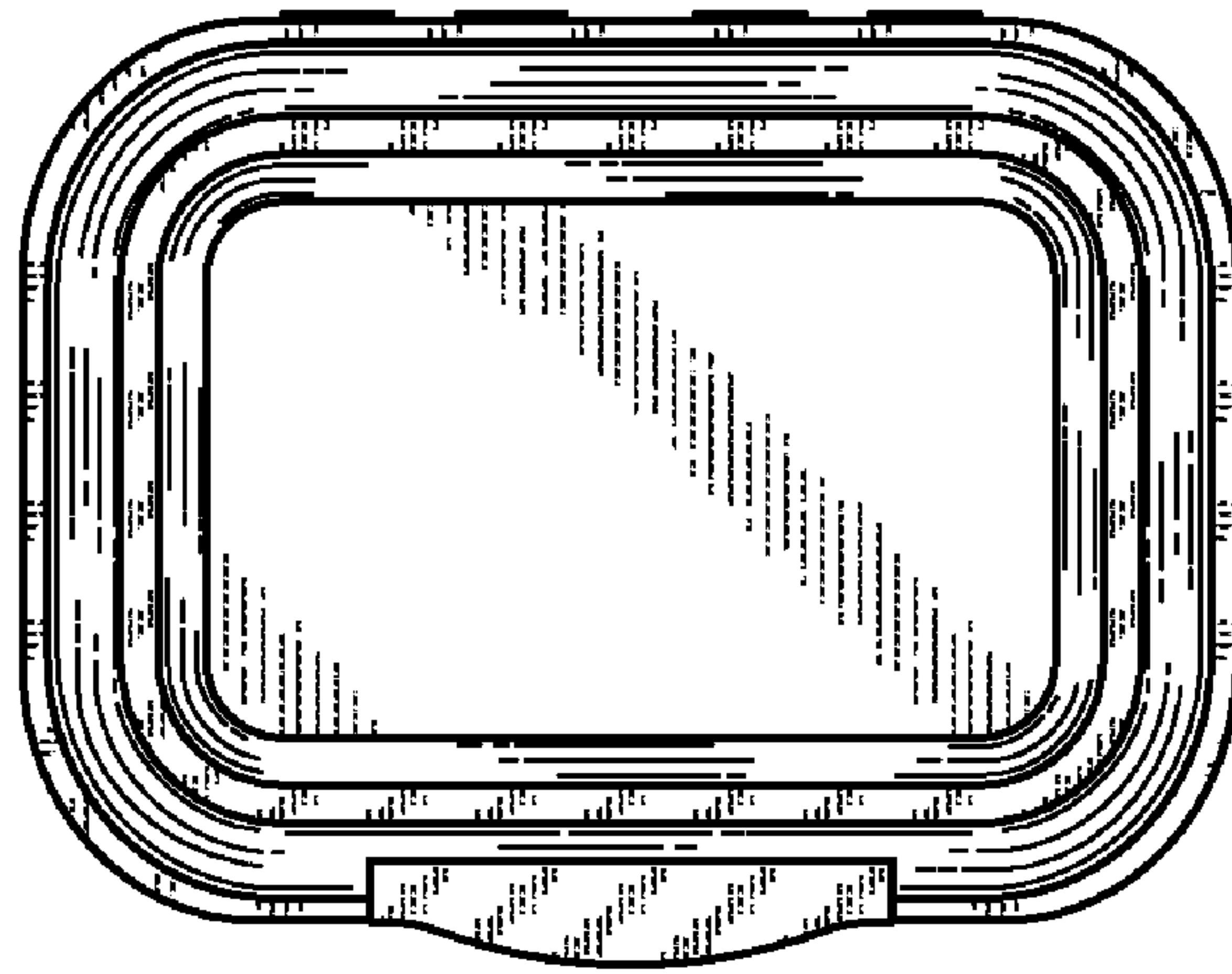

FIG. 6

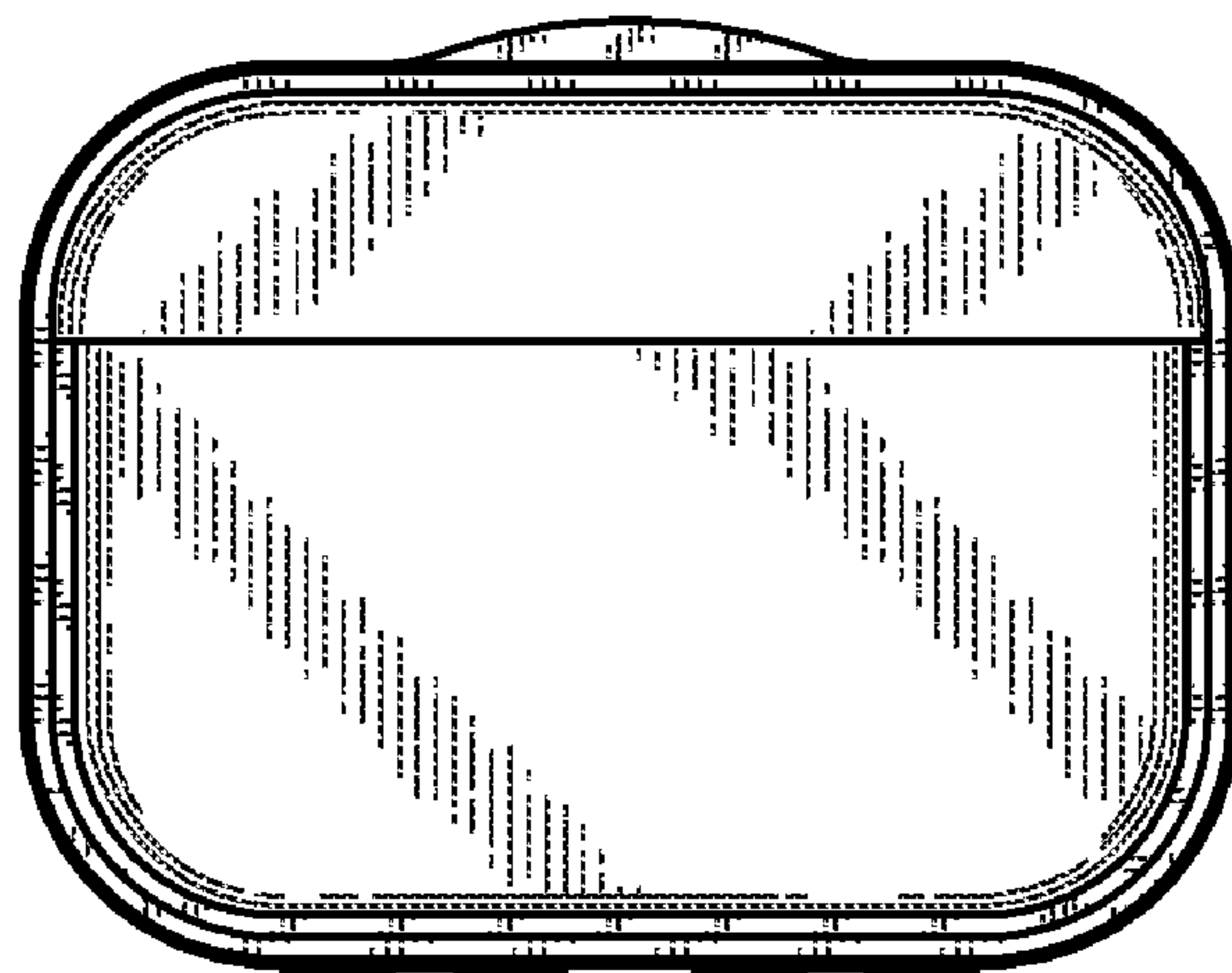

FIG. 7

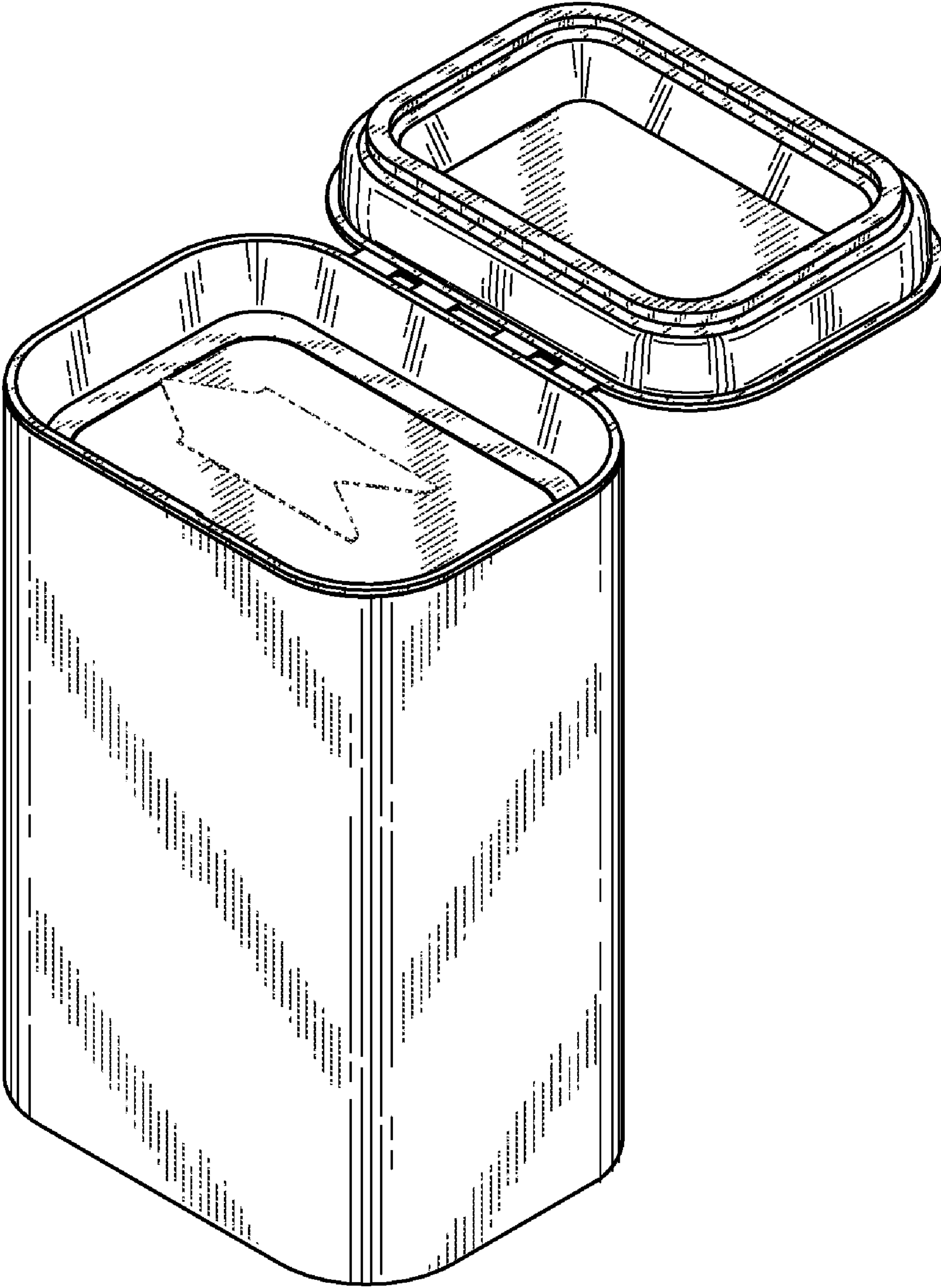

FIG. 8

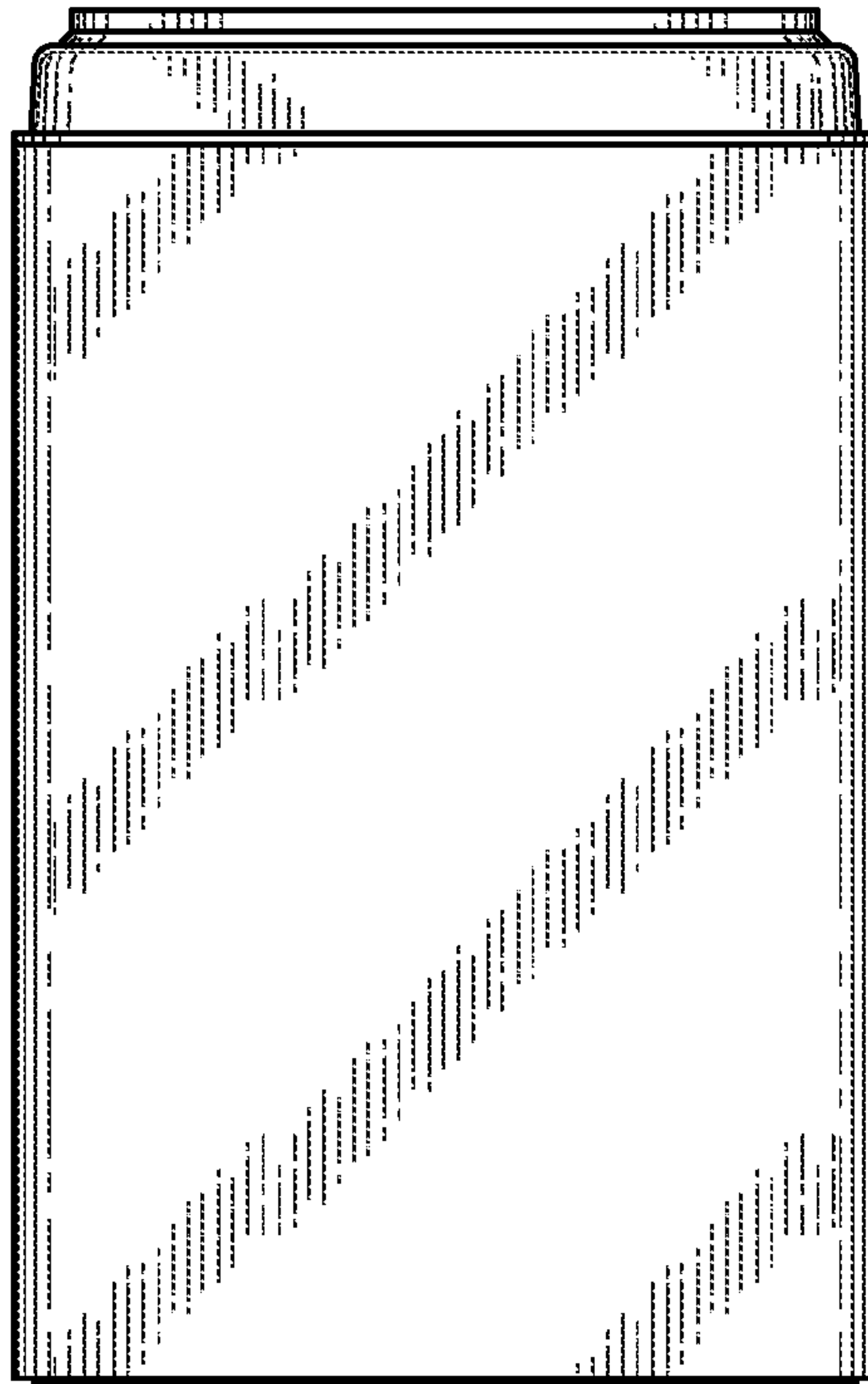

FIG. 9

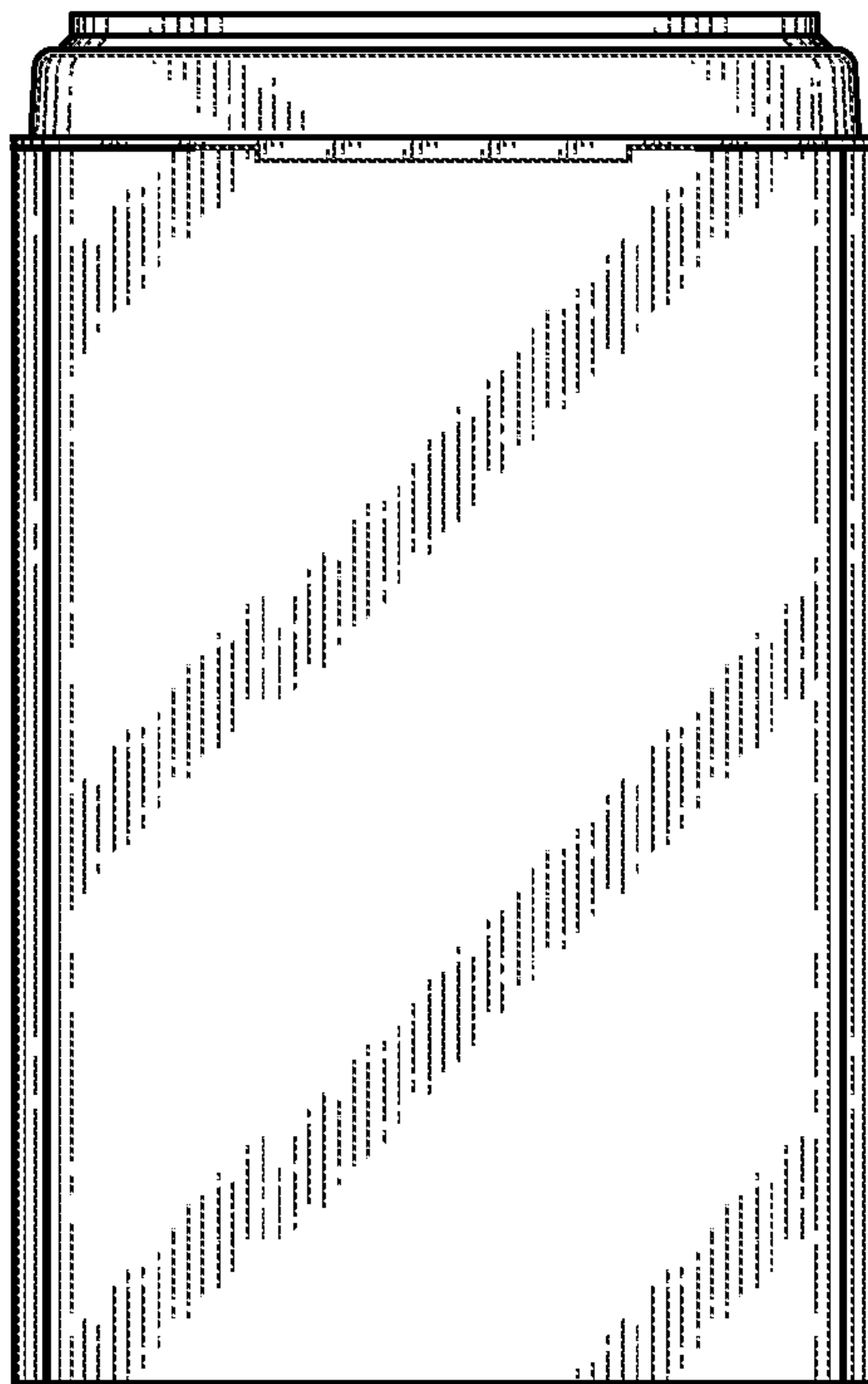

FIG. 10

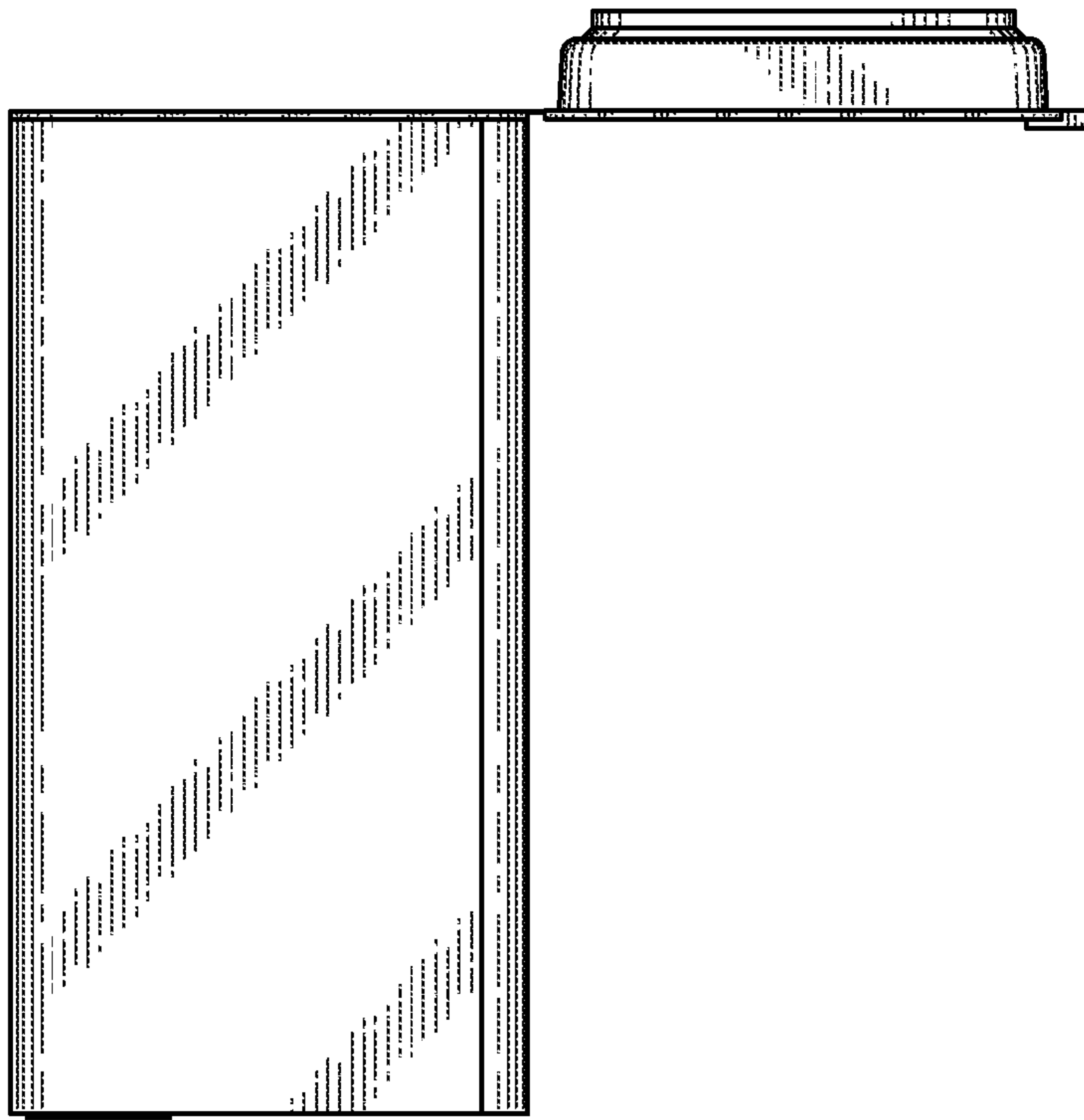

FIG. 11

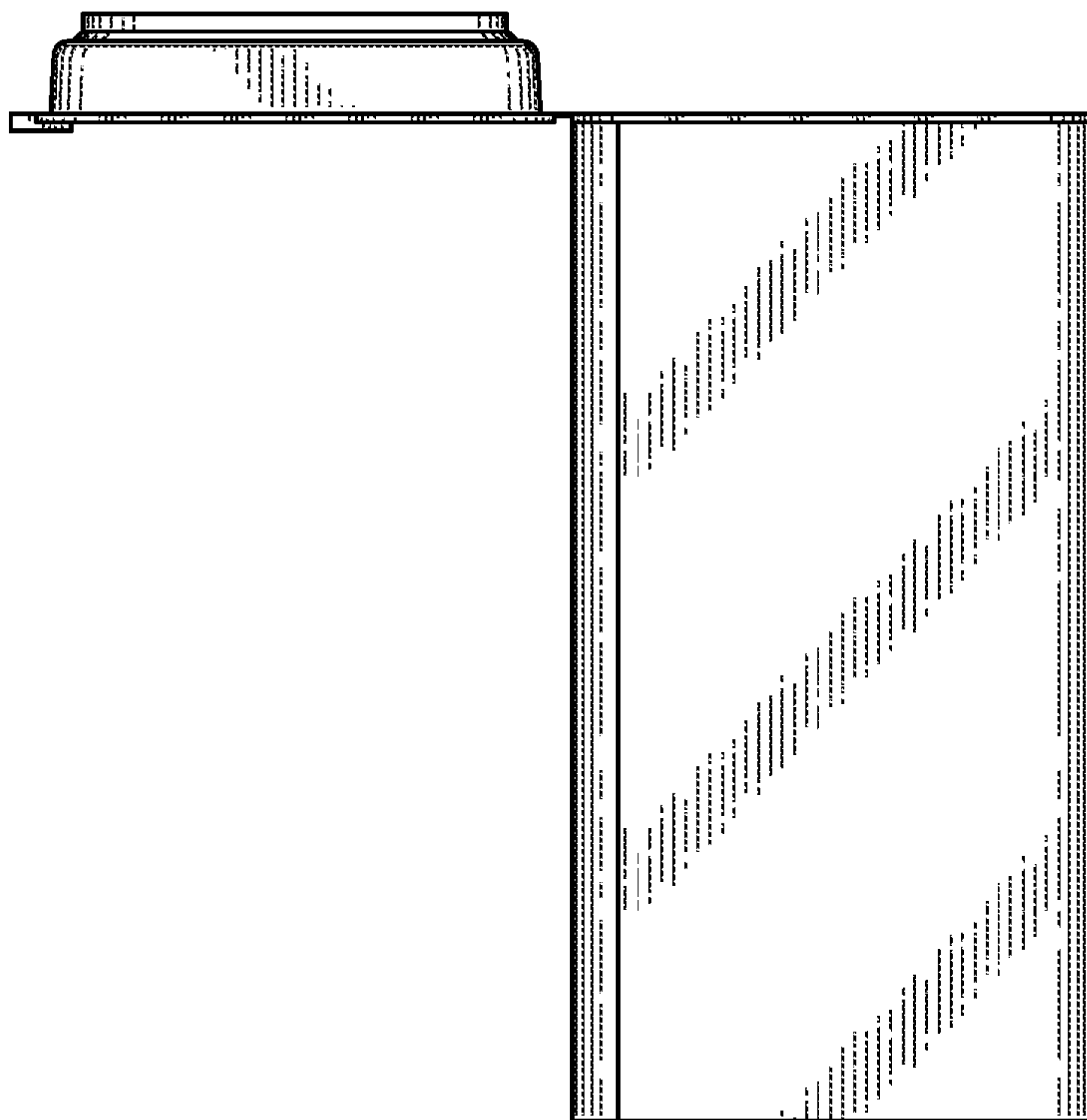

FIG. 12

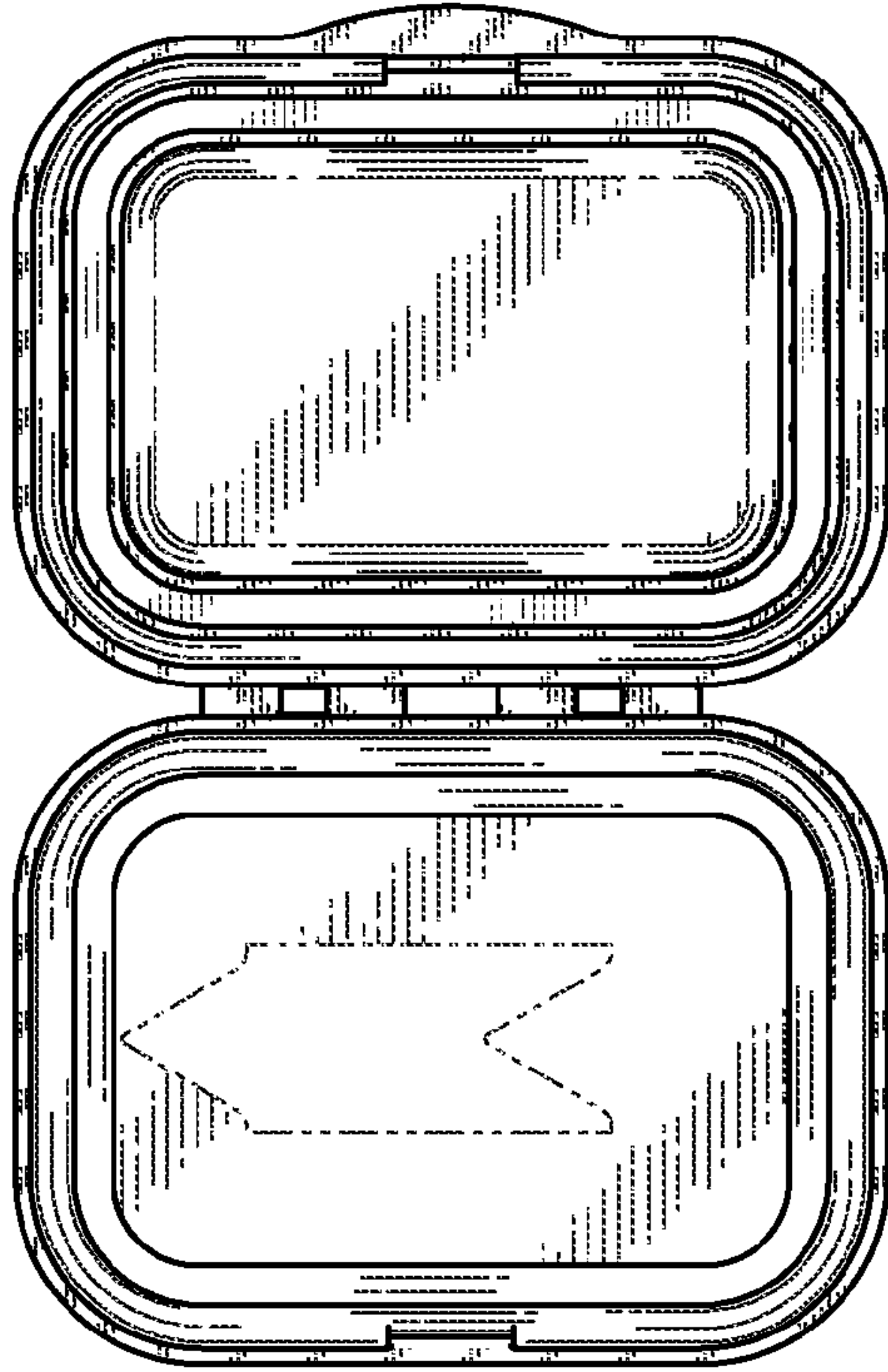

FIG. 13

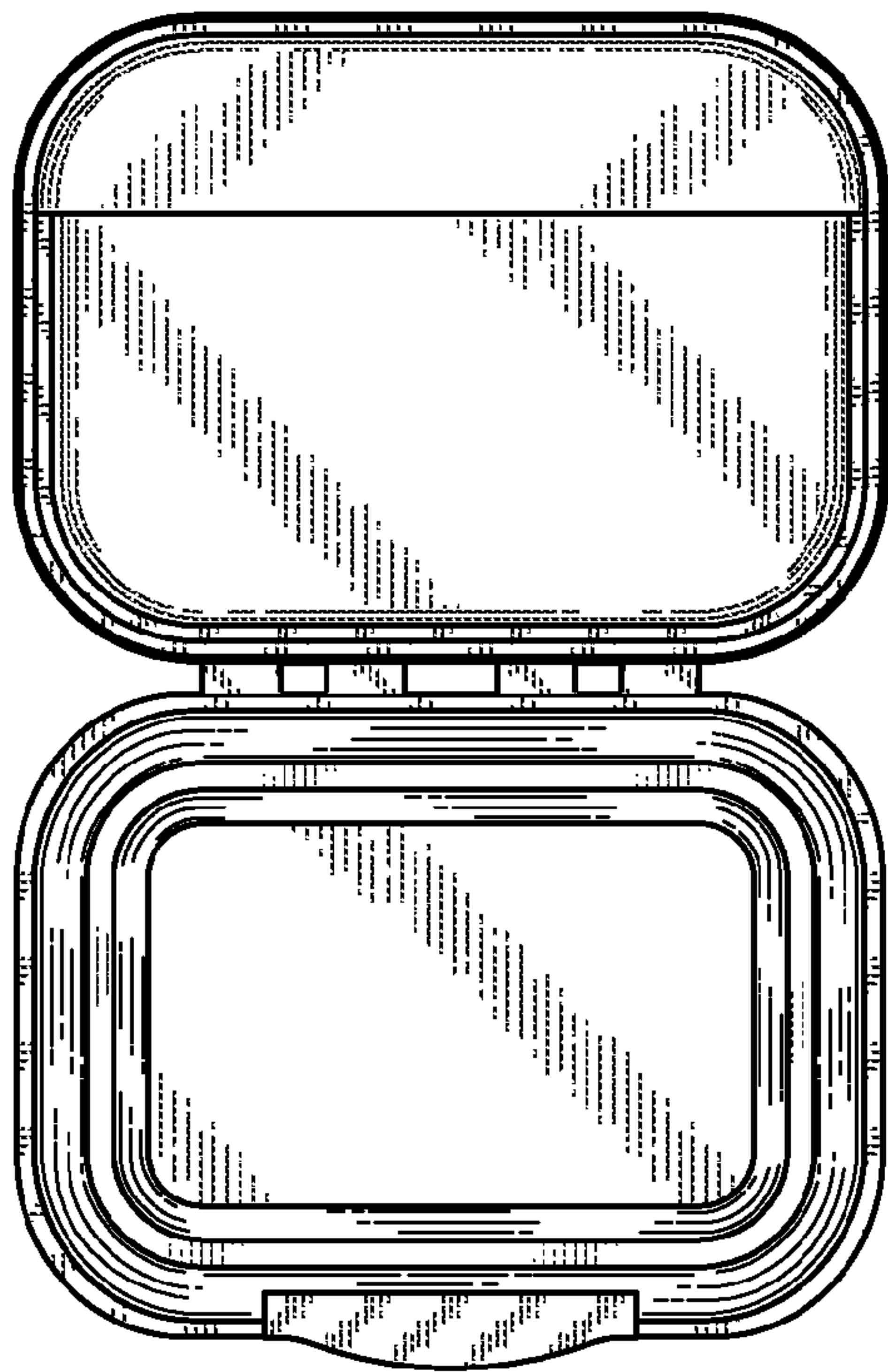

FIG. 14