



US00D571110S

(12) **United States Design Patent**
Potter

(10) **Patent No.:** **US D571,110 S**
(45) **Date of Patent:** **** Jun. 17, 2008**

(54) **MESSAGE CHAIR**

(75) Inventor: **David Potter**, Los Angeles, CA (US)

(73) Assignee: **Human Touch, LLC**, Long Beach, CA (US)

(**) Term: **14 Years**

(21) Appl. No.: **29/280,110**

(22) Filed: **May 16, 2007**

(51) **LOC (8) Cl.** **06-01**

(52) **U.S. Cl.** **D6/335**

(58) **Field of Classification Search** D6/334-338,
D6/360, 367, 374, 375, 482, 491, 495, 500-502,
D6/357, 364; 297/83, 157.1, 158.3, 170,
297/184.16, 188.14, 244, 423.19; 5/12.1,
5/12.2

See application file for complete search history.

(56) **References Cited**

U.S. PATENT DOCUMENTS

D476,792 S *	7/2003	Macari	D99/43
D502,607 S *	3/2005	Miyake et al.	D6/335
D511,900 S *	11/2005	Inada et al.	D6/367
D517,338 S *	3/2006	Inada et al.	D6/367
D536,891 S *	2/2007	Miyake et al.	D6/367
D536,893 S *	2/2007	Lifeng	D6/367
D536,894 S *	2/2007	Potter	D6/367
D536,895 S *	2/2007	Kawamura	D6/367
D537,643 S *	3/2007	Miyake	D6/367
D538,056 S *	3/2007	Lifeng	D6/367
D539,051 S *	3/2007	Dehli et al.	D6/367
D540,053 S *	4/2007	Kimoto	D6/367
D544,224 S *	6/2007	Zhuo	D6/367
D547,558 S *	7/2007	Egger	D6/334
D548,995 S *	8/2007	Ng	D6/367
D550,468 S *	9/2007	Ng	D6/367

* cited by examiner

Primary Examiner—Sandra Snapp
(74) *Attorney, Agent, or Firm*—Christie, Parker & Hale, LLP.

(57) **CLAIM**

The ornamental design for massage chair, as shown and described.

DESCRIPTION

FIG. 1 is a perspective view of the massage chair according to the present invention;

FIG. 2 is a front view of the massage chair according to the present invention;

FIG. 3 is a side view of the massage chair according to the present invention;

FIG. 4 is a rear view of the massage chair according to the present invention;

FIG. 5 is another side view of the massage chair according to the present invention;

FIG. 6 is a top view of the massage chair according to the present invention;

FIG. 7 is a perspective view of an alternate embodiment of the massage chair according to the present invention without the back pad;

FIG. 8 is a front view of an alternate embodiment of the massage chair according to the present invention without the back pad;

FIG. 9 is a side view of an alternate embodiment of the massage chair according to the present invention without the back pad;

FIG. 10 is another side view of an alternate embodiment of the massage chair according to the present invention without the back pad; and,

FIG. 11 is a top view of an alternate embodiment of the massage chair according to the present invention without the back pad.

1 Claim, 11 Drawing Sheets

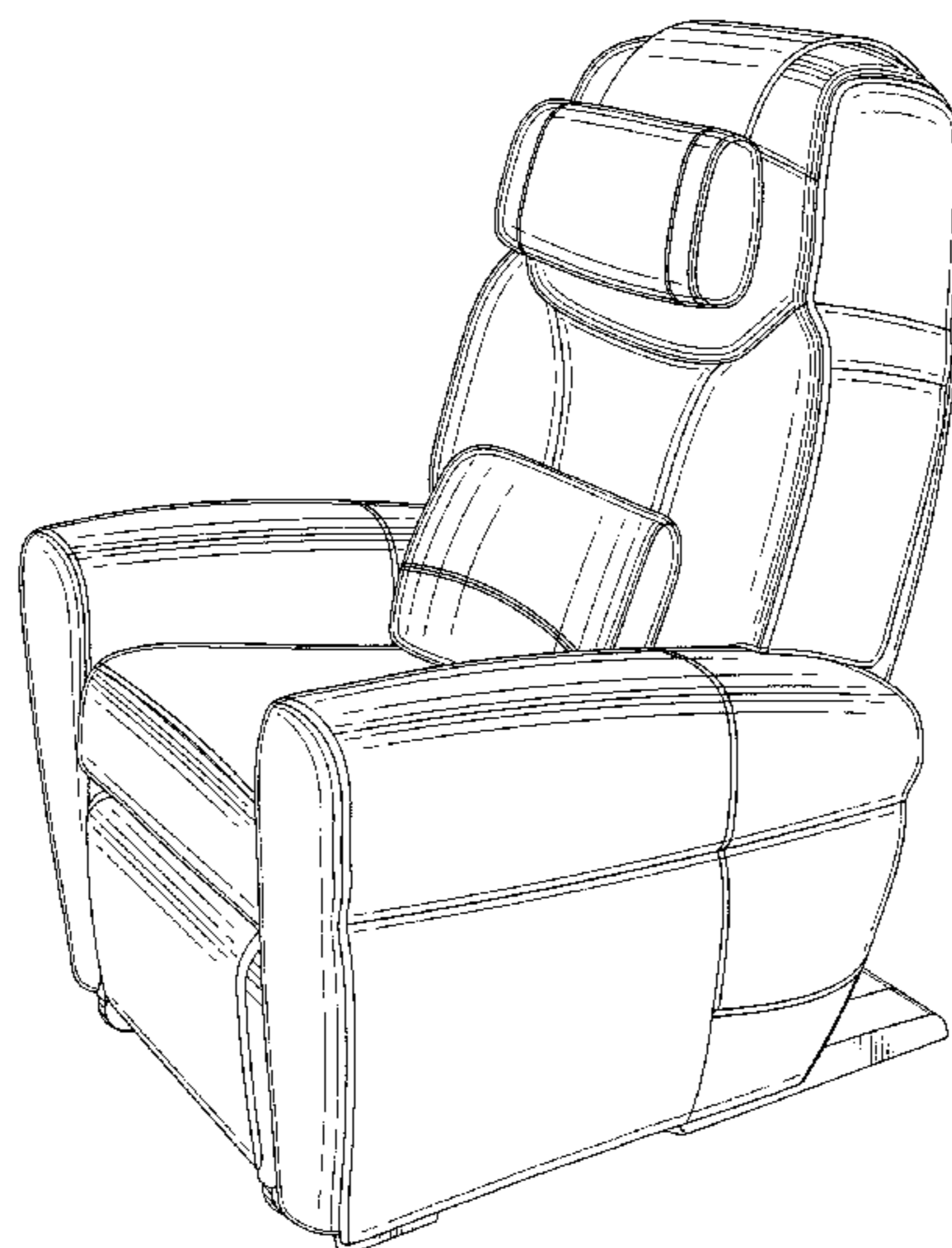

FIG. 1

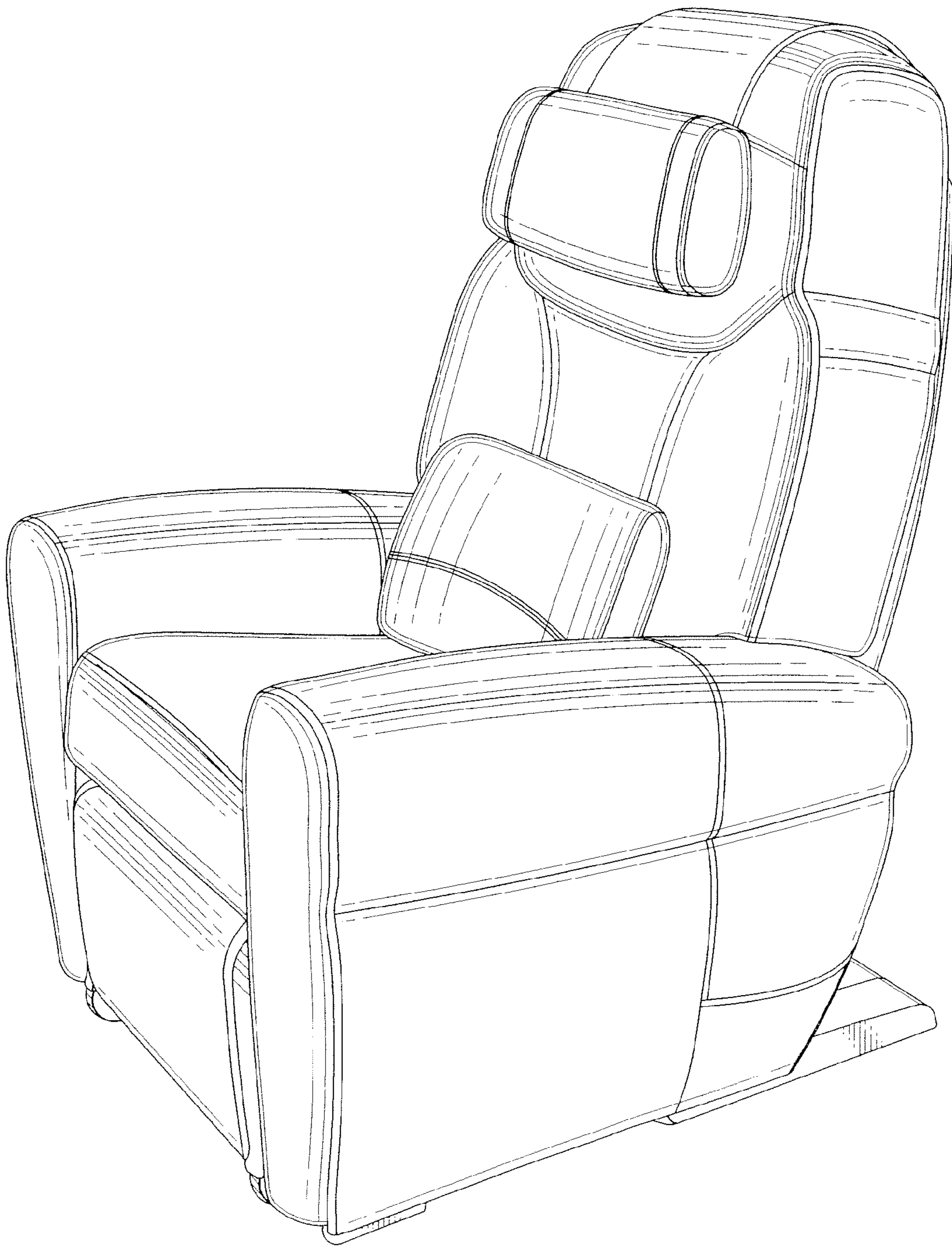

FIG. 2

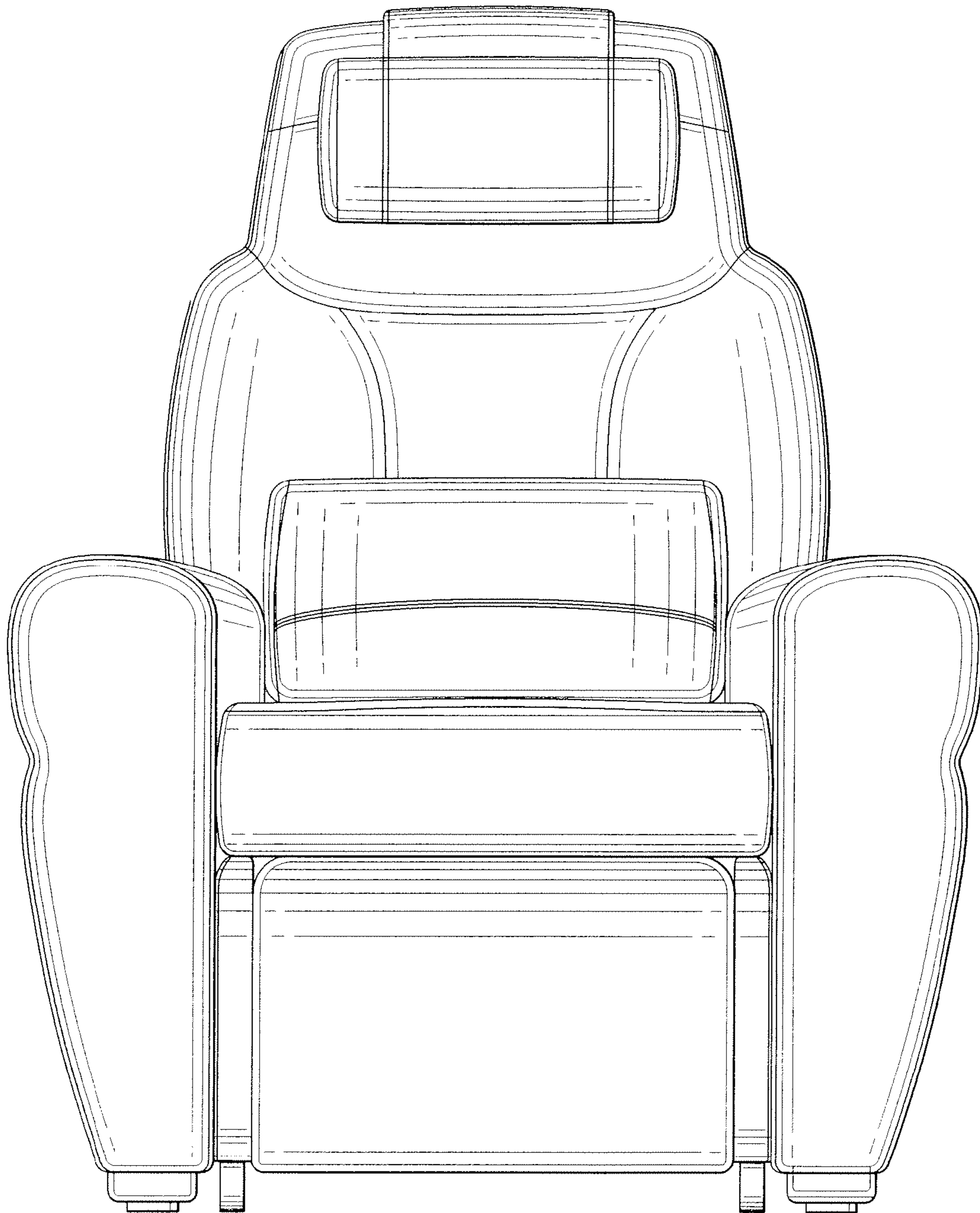

FIG. 3



FIG. 4

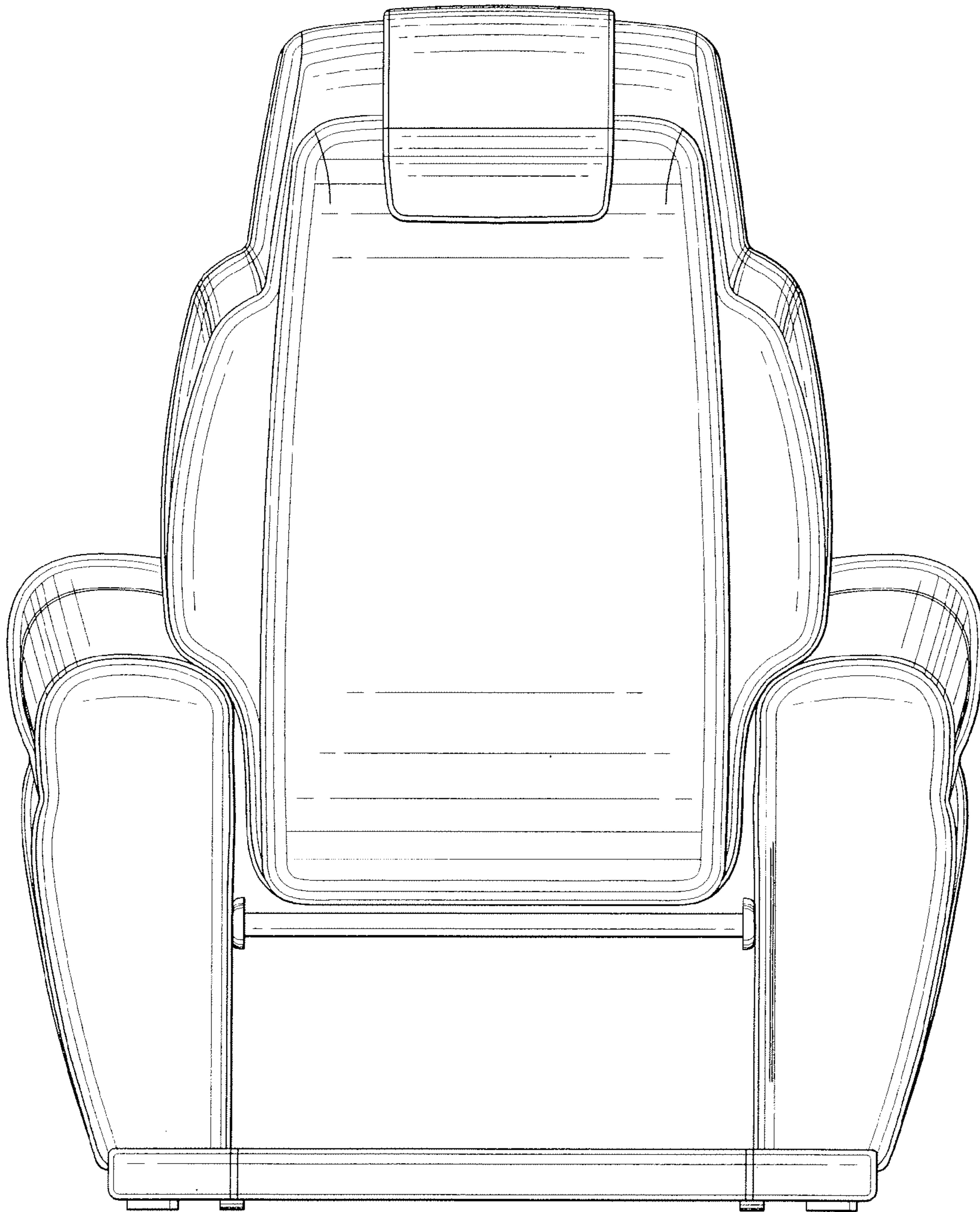

FIG. 5

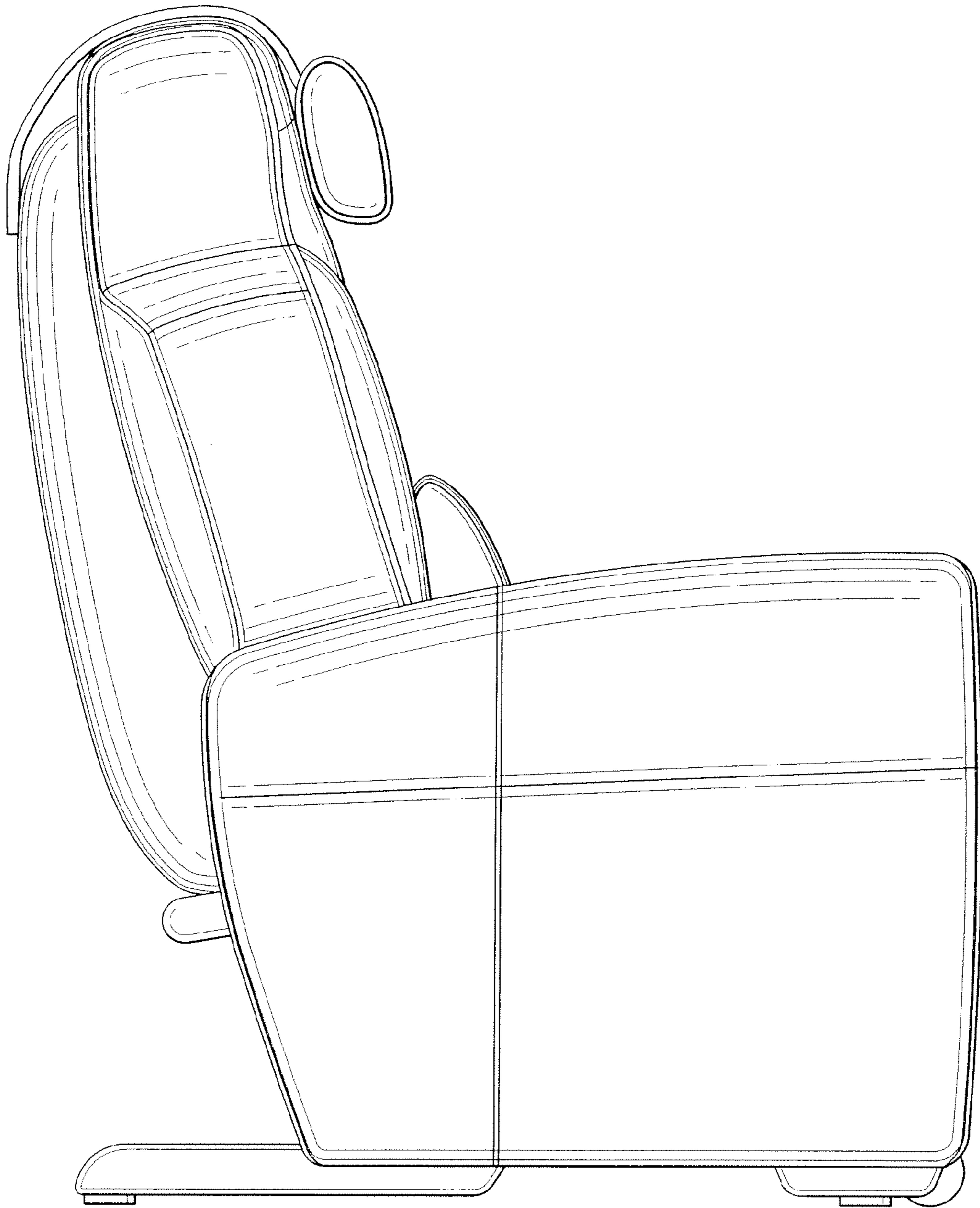

FIG. 6

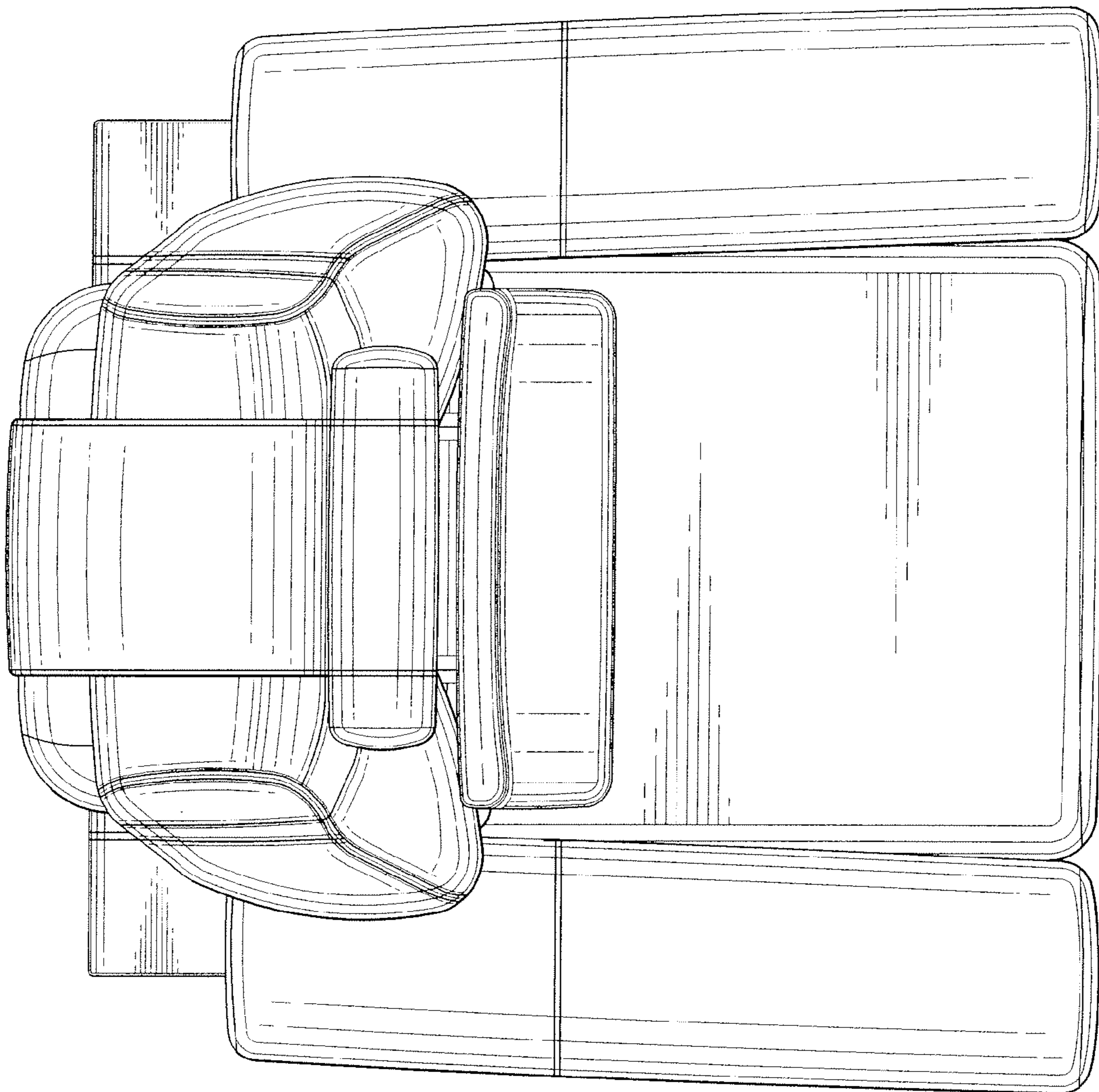

FIG. 7

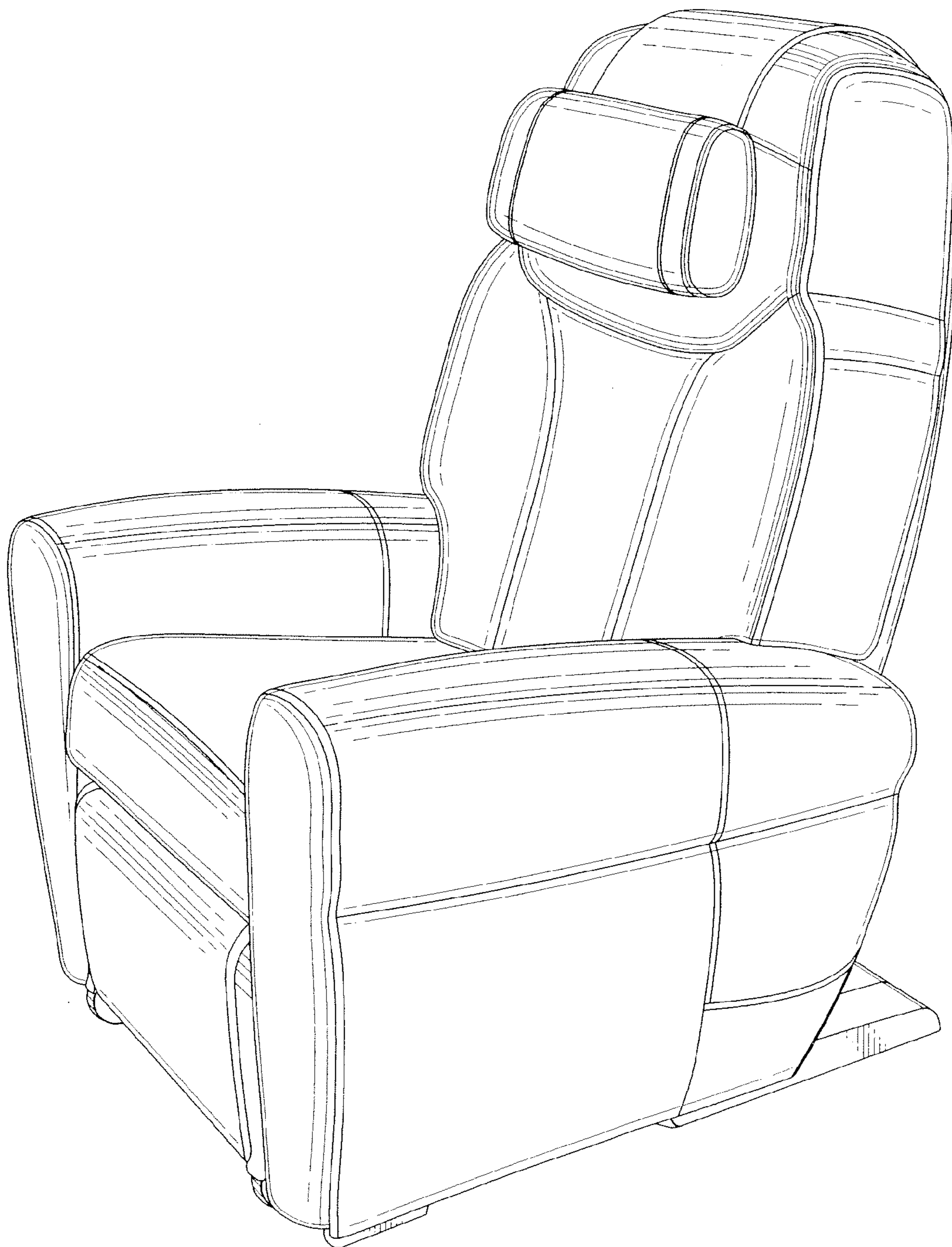

FIG. 8

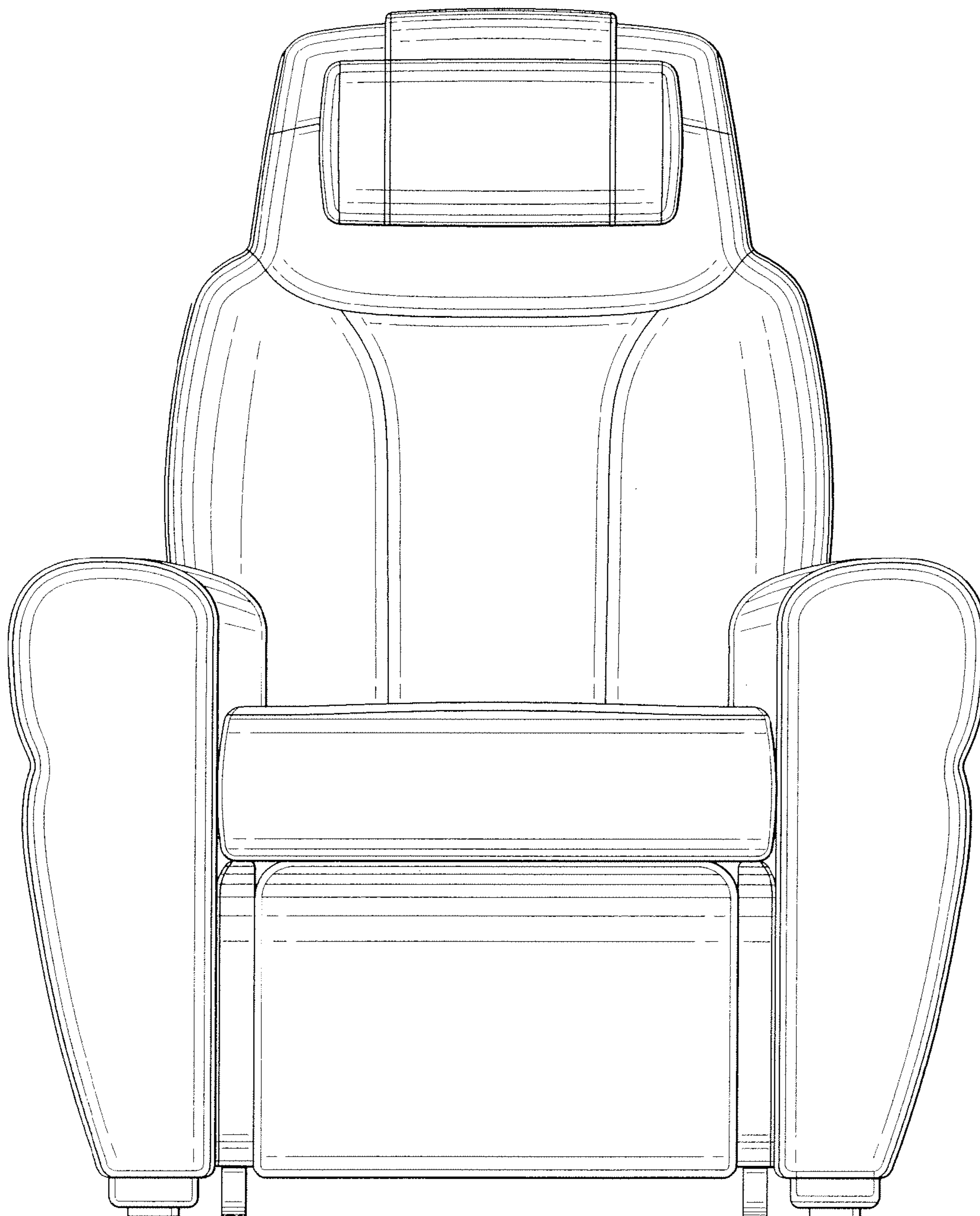

FIG. 9



FIG. 10

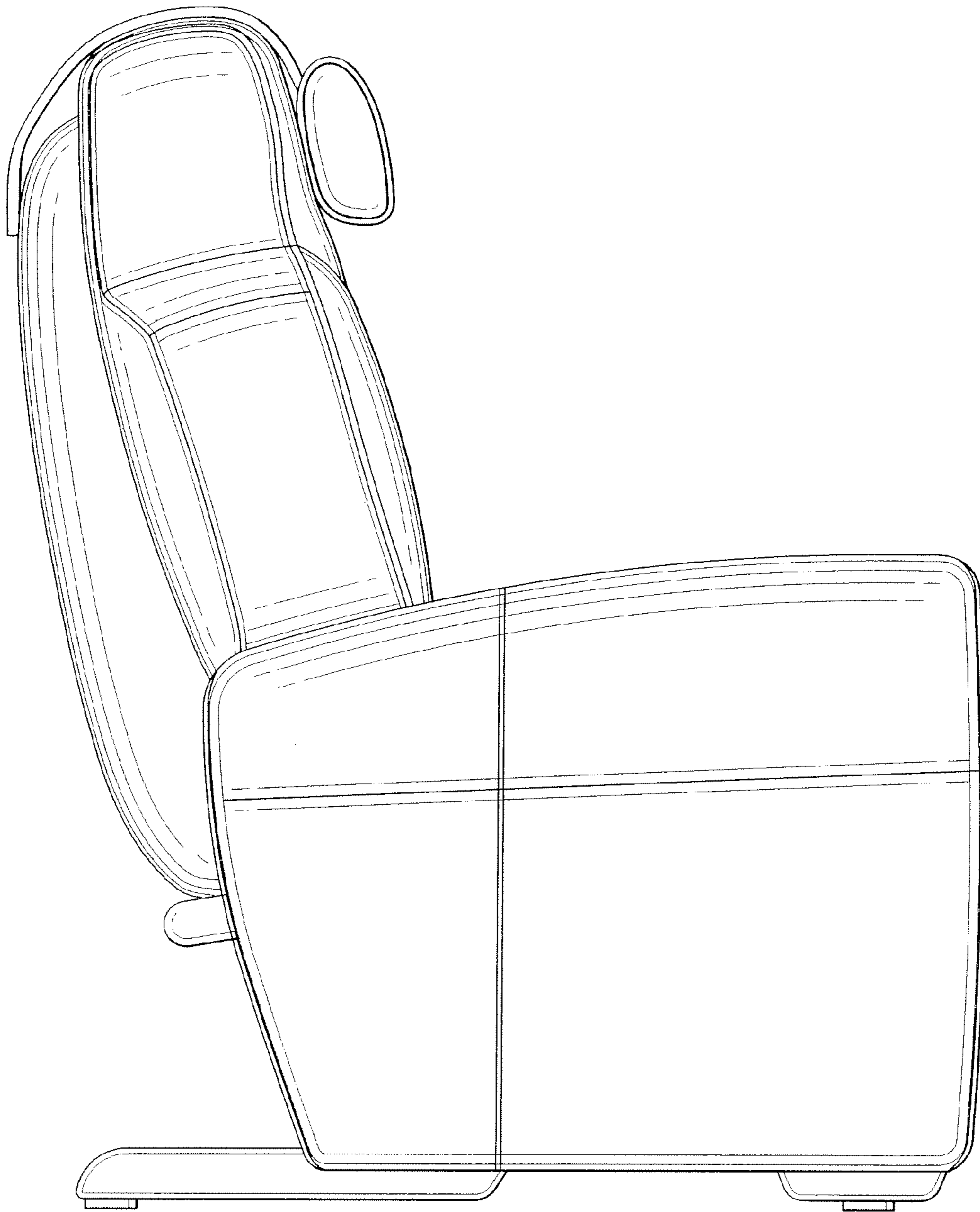

FIG. 11

