

US00D571034S

(12) **United States Design Patent**  
**Goetz-Schaefer**

(10) **Patent No.:** **US D571,034 S**

(45) **Date of Patent:** **\*\* Jun. 10, 2008**

(54) **WALL LIGHT**

(75) Inventor: **Katharina Goetz-Schaefer**, Bad Salzuflen (DE)

(73) Assignee: **Zumtobel Lighting GmbH & Co. KG**, Lemgo (DE)

(\*\*) Term: **14 Years**

(21) Appl. No.: **29/298,851**

(22) Filed: **Dec. 13, 2007**

**Related U.S. Application Data**

(62) Division of application No. 29/264,620, filed on Aug. 14, 2006.

(30) **Foreign Application Priority Data**

Feb. 16, 2006 (EM) ..... 000 480 504-0001  
Feb. 16, 2006 (EM) ..... 000 480 504-0002

(51) **LOC (8) Cl.** ..... **26-03**

(52) **U.S. Cl.** ..... **D26/85; D26/89**

(58) **Field of Classification Search** ..... D26/72,  
D26/85, 88, 89, 138, 142, 149, 152; 362/147,  
362/431, 432, 362

See application file for complete search history.

(56) **References Cited**

**U.S. PATENT DOCUMENTS**

D30,094 S \* 1/1899 Busch ..... D26/152

D48,874 S \* 4/1916 Tepfer ..... D26/142  
D68,011 S \* 8/1925 McFadden ..... D26/149  
D426,339 S \* 6/2000 Chen ..... D26/85  
D475,802 S \* 6/2003 Homann ..... D26/74  
D549,866 S \* 8/2007 Pan ..... D26/89

\* cited by examiner

*Primary Examiner*—Clare E Heflin

(74) *Attorney, Agent, or Firm*—Marshall, Gerstein & Borun LLP

(57) **CLAIM**

The ornamental design for wall light, as shown.

**DESCRIPTION**

FIG. 1 is perspective view of a wall light that has the design.

FIG. 2 is another perspective view of the wall light.

FIG. 3 is a side view of the wall light.

FIG. 4 is an opposite side view of the wall light.

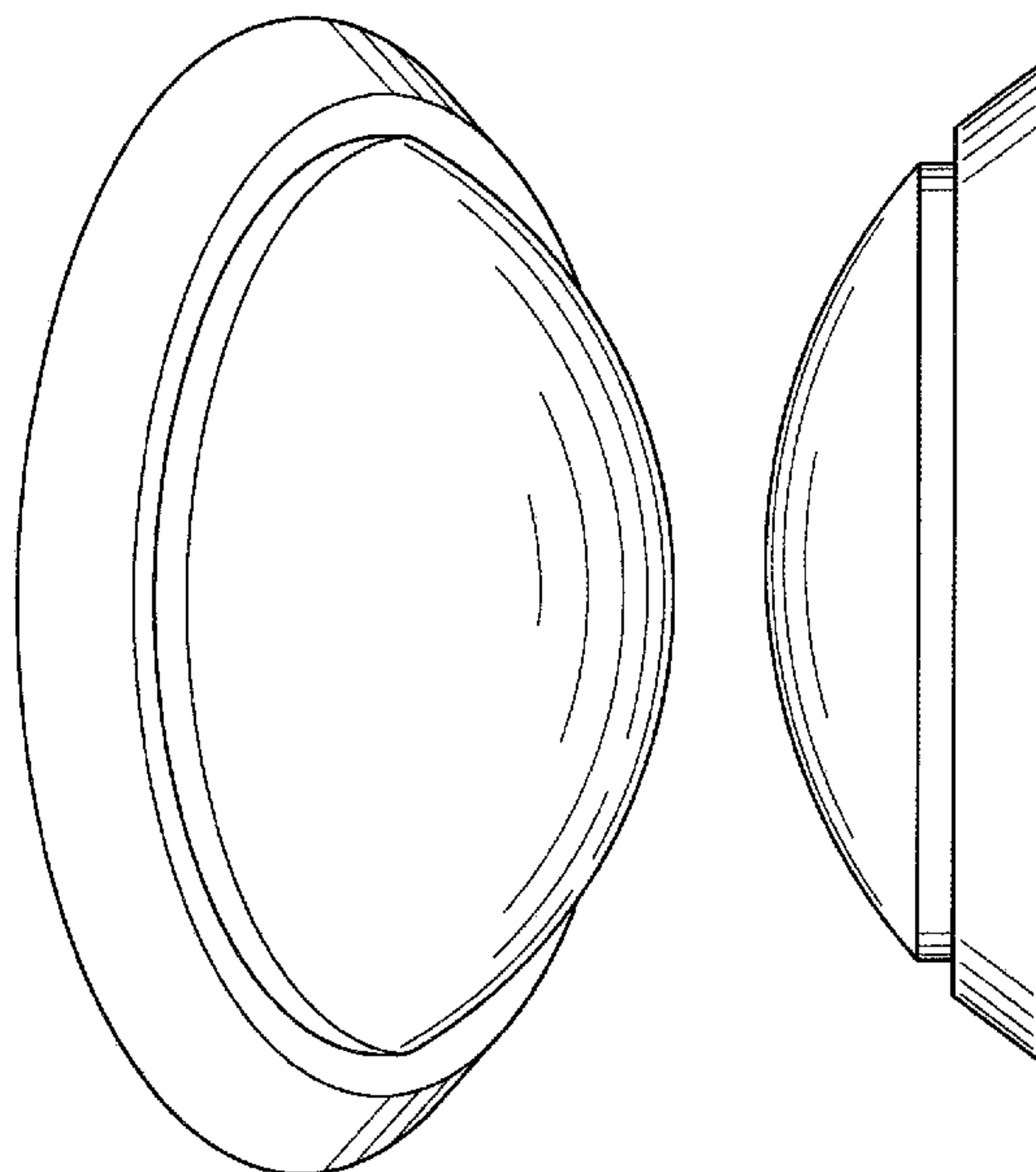
FIG. 5 is a front view of the wall light.

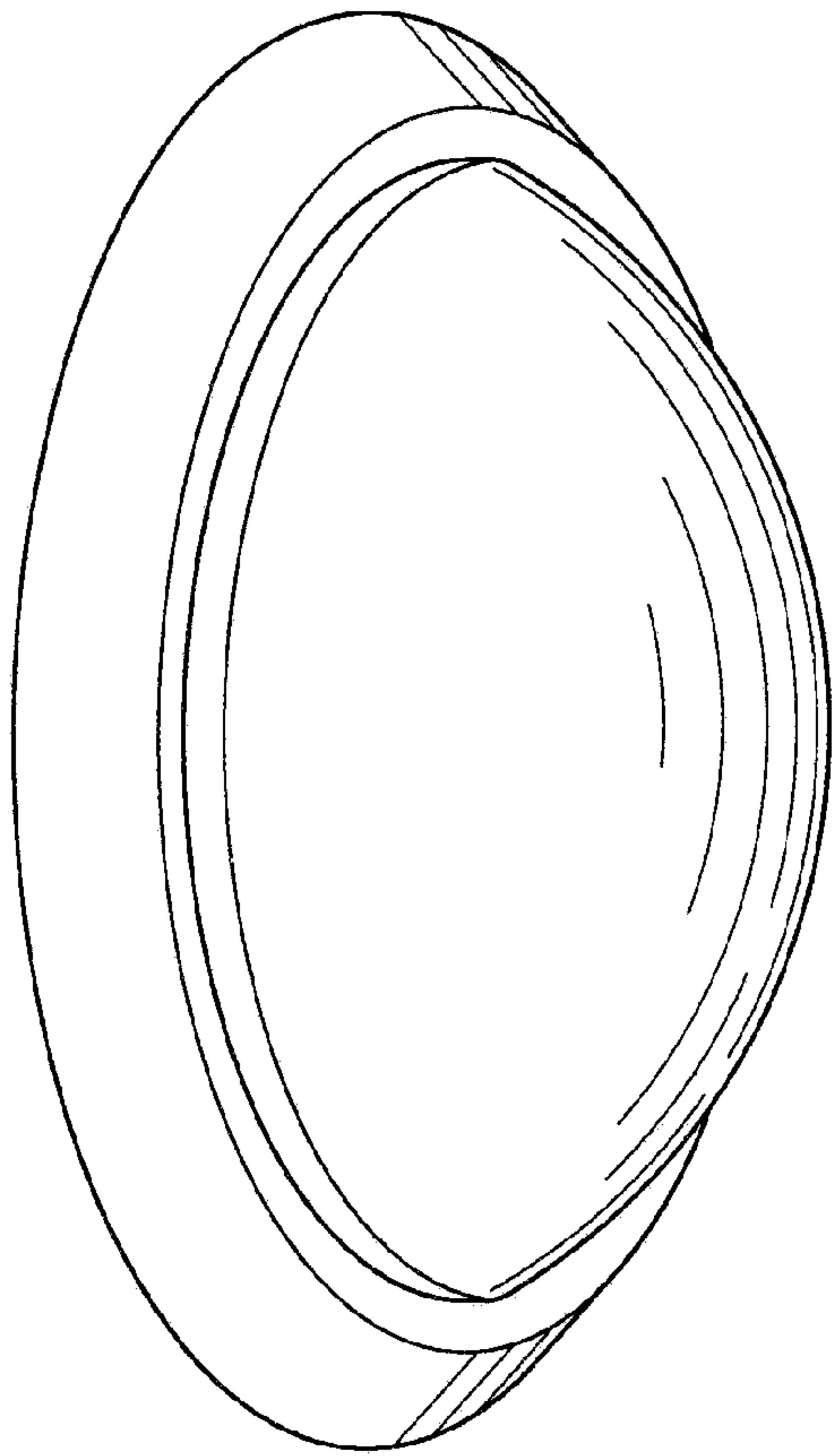
FIG. 6 is a top view of the wall light.

FIG. 7 is a rear view of the wall light; and,

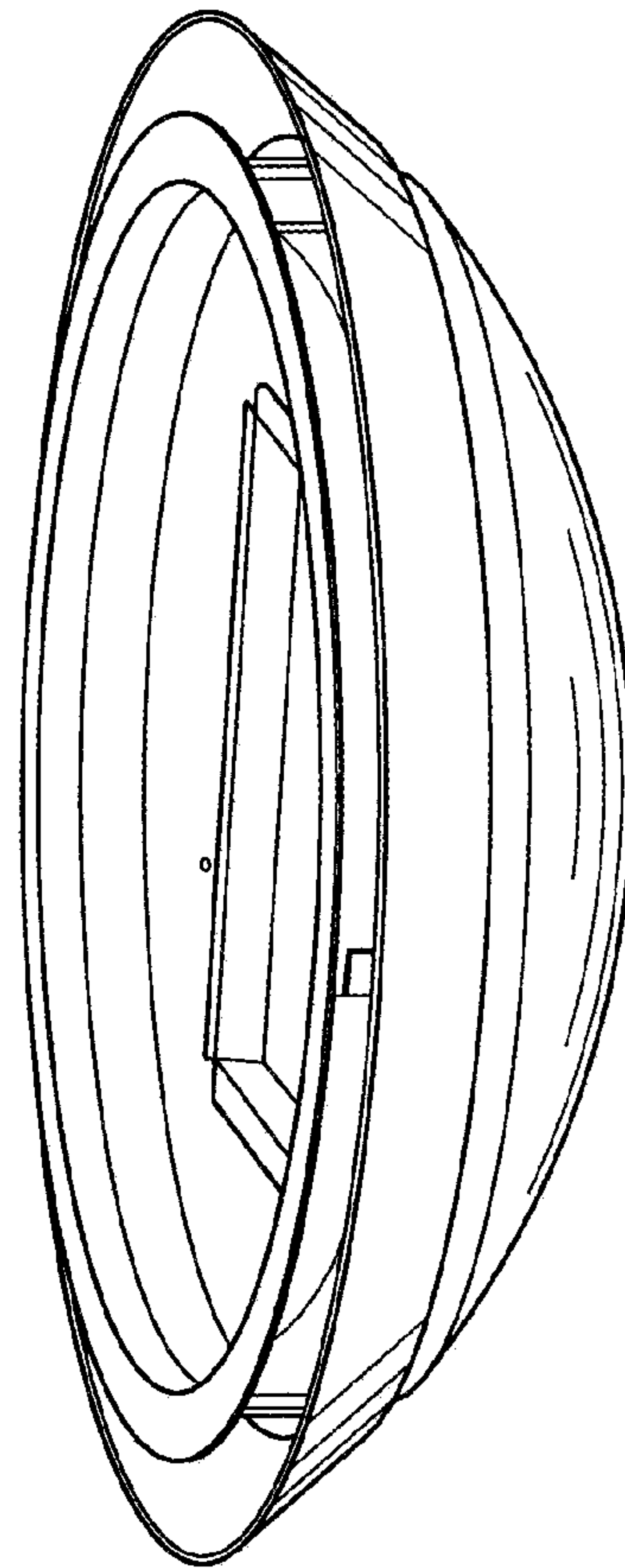
FIG. 8 is a bottom view of the wall light.

**1 Claim, 3 Drawing Sheets**

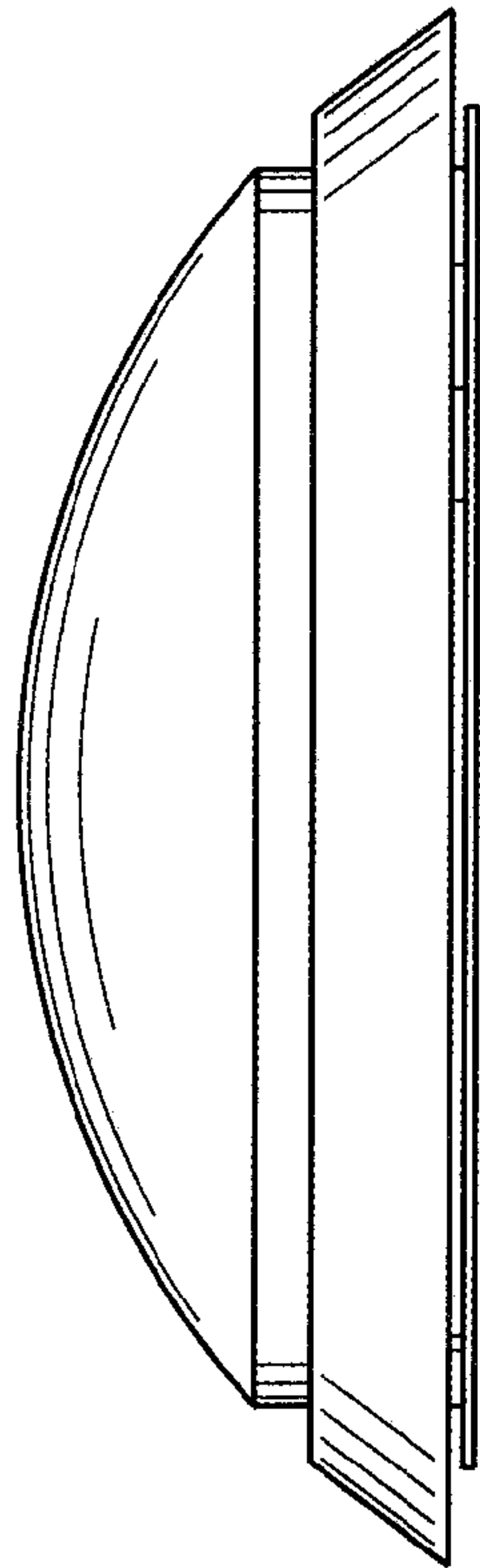




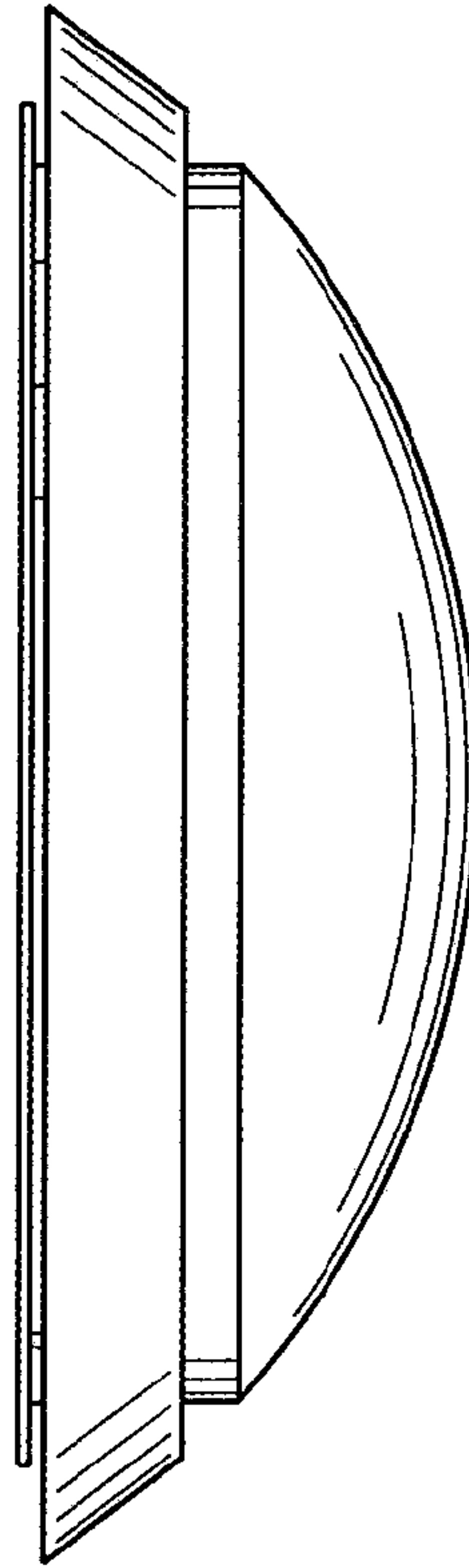
**FIG. 1**



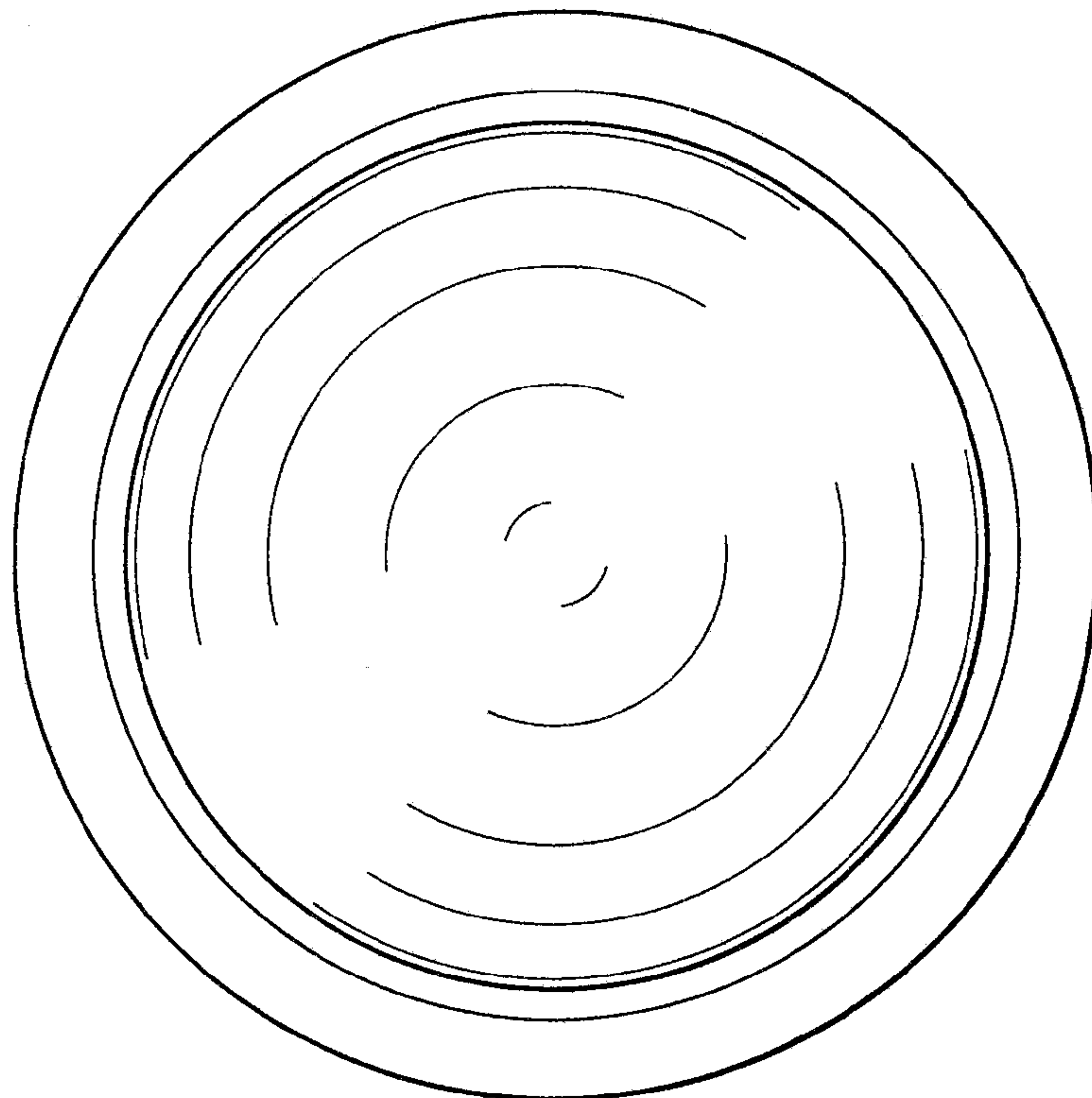
**FIG. 2**



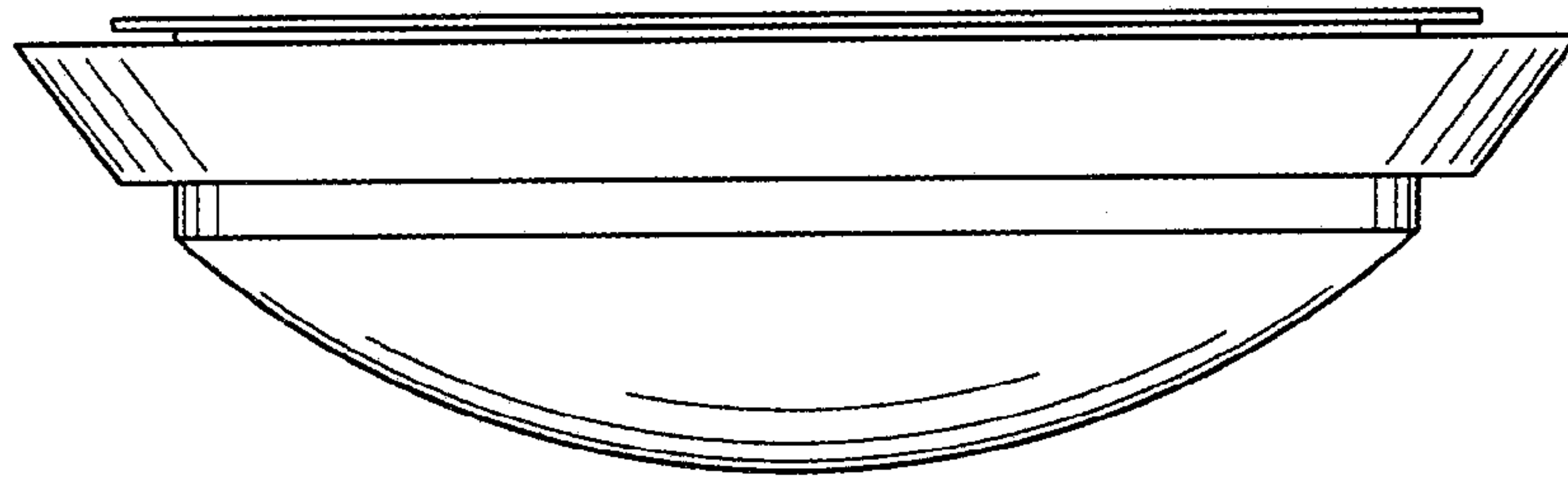
**FIG. 3**



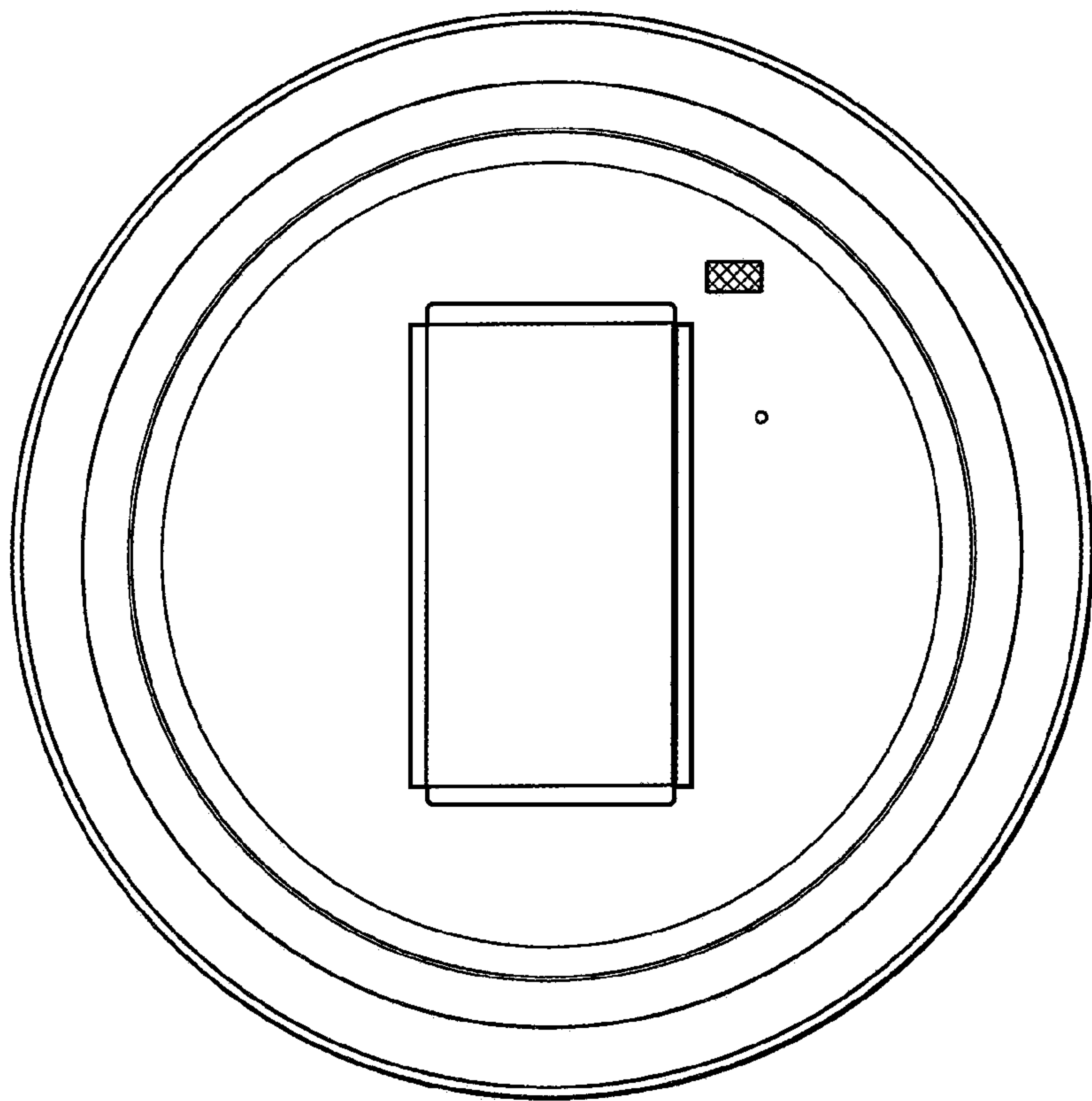
**FIG. 4**



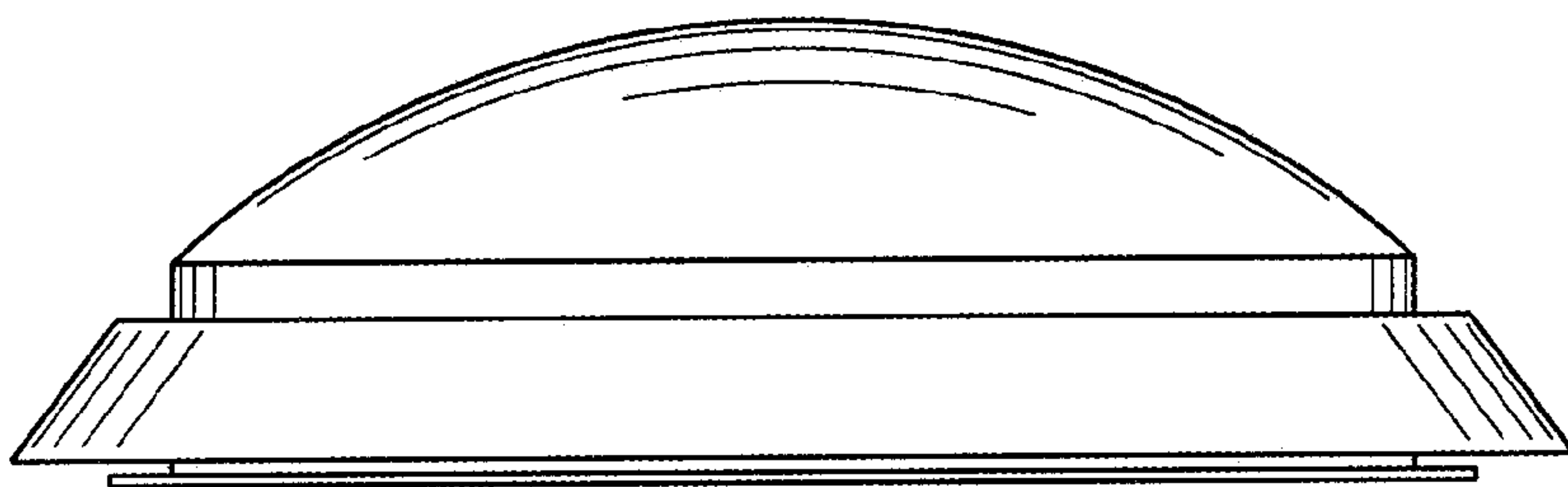
**FIG. 5**



**FIG. 6**



**FIG. 7**



**FIG. 8**