



US00D571032S

(12) **United States Design Patent**
Chen

(10) **Patent No.:** **US D571,032 S**

(45) **Date of Patent:** **** Jun. 10, 2008**

(54) **LAMP**

D526,433 S * 8/2006 Li D26/60
D542,453 S * 5/2007 Osiecki et al. D26/60

(76) Inventor: **Shin-Fei Chen**, No 477, Sinsheng Rd.,
Yuanlin Township, Changhua County
510 (TW)

(**) Term: **14 Years**

(21) Appl. No.: **29/280,481**

(22) Filed: **May 30, 2007**

(51) **LOC (8) Cl.** **26-05**

(52) **U.S. Cl.** **D26/61**

(58) **Field of Classification Search** D26/14,
D26/60-66, 93, 37, 38, 50; 362/410, 413,
362/414, 419, 427, 285, 287, 282, 277, 275,
362/274, 271, 270, 269, 431; D14/147, 148,
D14/251

See application file for complete search history.

(56) **References Cited**

U.S. PATENT DOCUMENTS

D290,884 S * 7/1987 Sano et al. D26/65
D357,990 S * 5/1995 Cheng et al. D26/38
D462,950 S * 9/2002 Waffensmith et al. D14/251
D496,480 S * 9/2004 Slattery et al. D26/38
D518,586 S * 4/2006 Kaufman D26/60
D521,671 S * 5/2006 Chen et al. D26/65
D524,474 S * 7/2006 Lo et al. D26/60

OTHER PUBLICATIONS

<http://www.lampsplus.com>—Flip Rechargeable LED Desk and
Travel, product #49665; no website date.*

* cited by examiner

Primary Examiner—Cathron Brooks

Assistant Examiner—Barbara Fox

(74) *Attorney, Agent, or Firm*—Alan Kamrath; Kamrath &
Associates PA

(57) **CLAIM**

The ornamental design for a lamp, as shown and described.

DESCRIPTION

FIG. 1 is a perspective view of a lamp showing my design;
FIG. 2 is a front elevational view thereof;
FIG. 3 is a rear elevational view thereof;
FIG. 4 is a left side elevational view thereof;
FIG. 5 is a right side elevational view thereof;
FIG. 6 is a top plan view thereof; and,
FIG. 7 is a bottom plan view thereof.

1 Claim, 7 Drawing Sheets

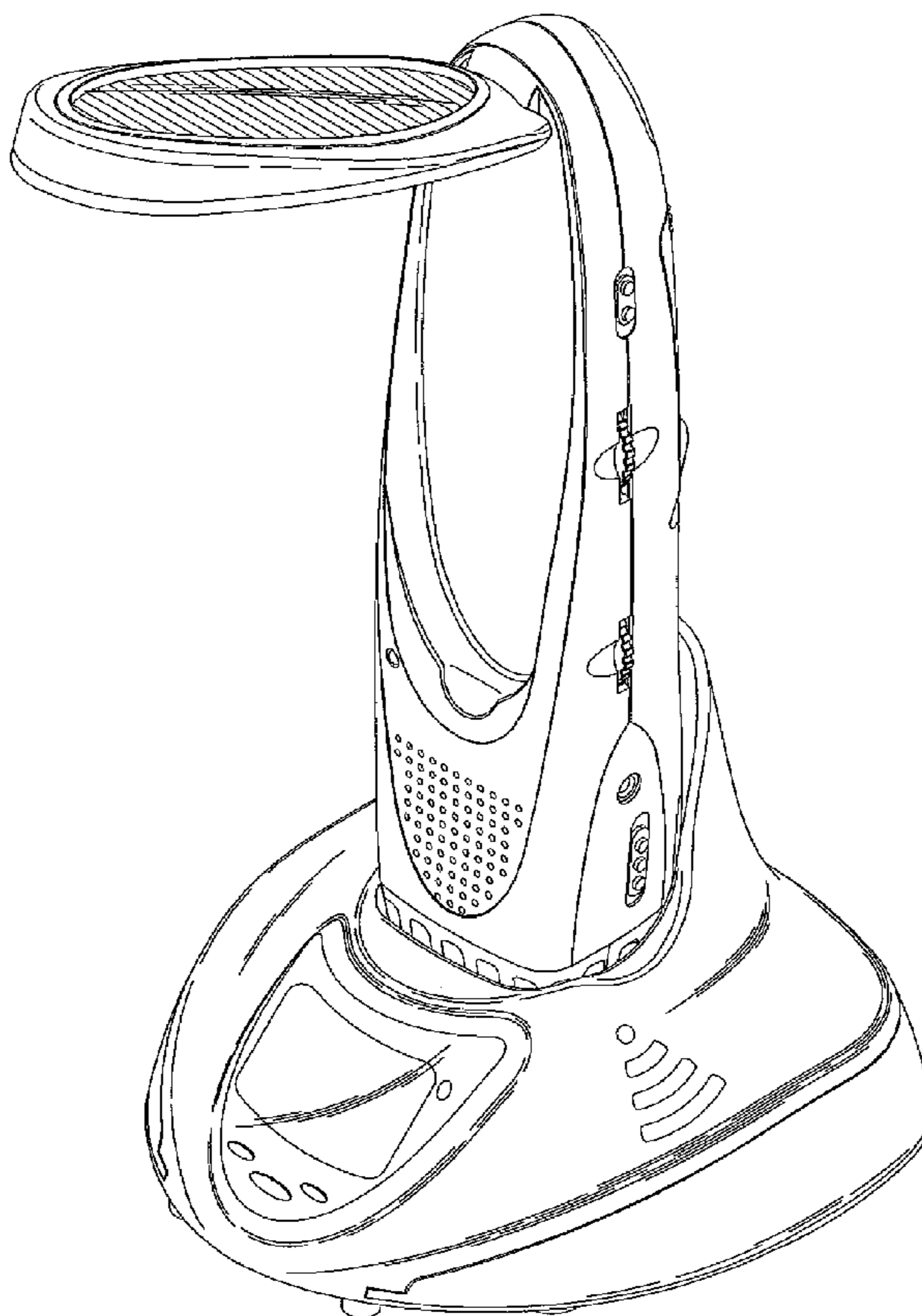

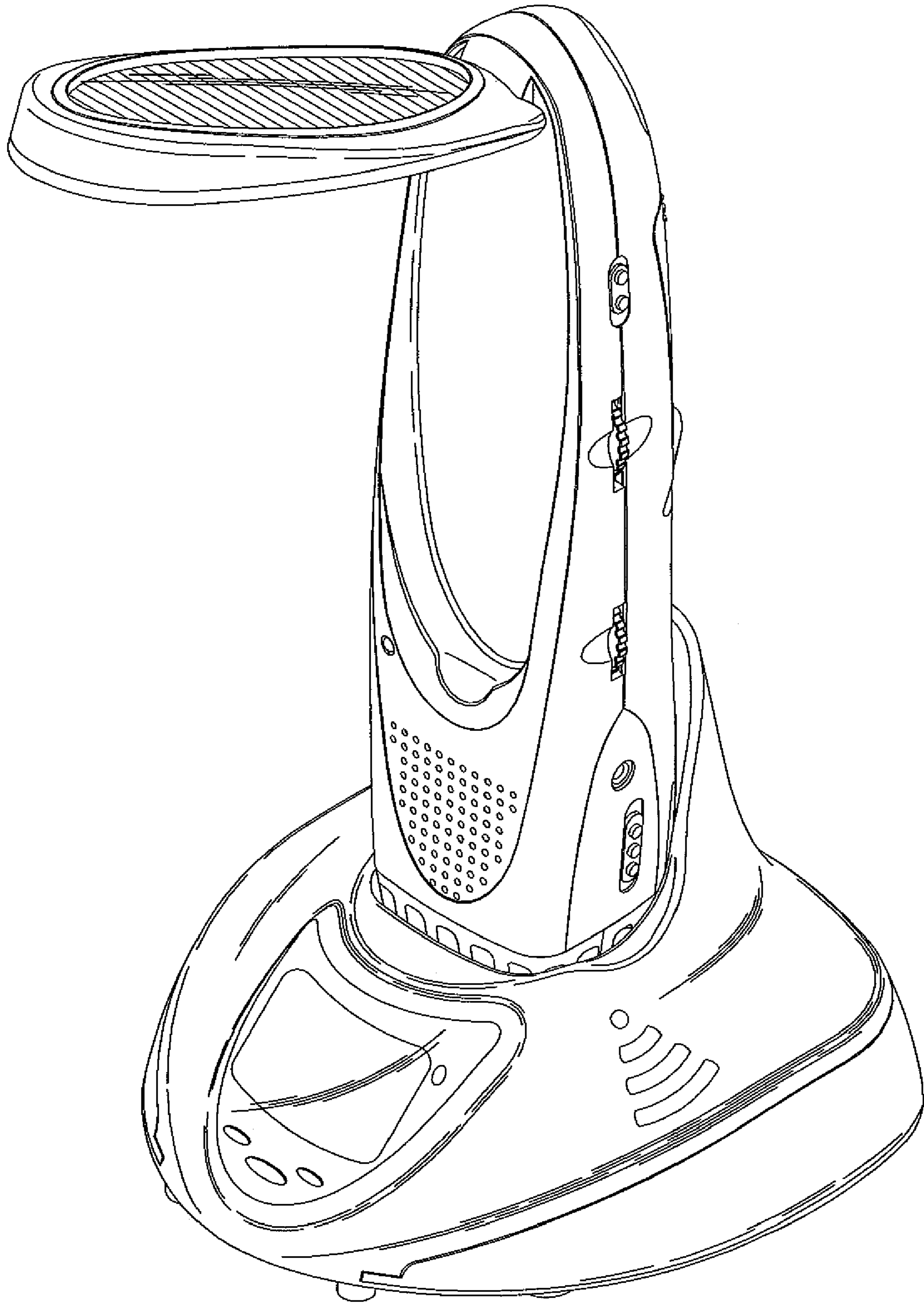

FIG. 1

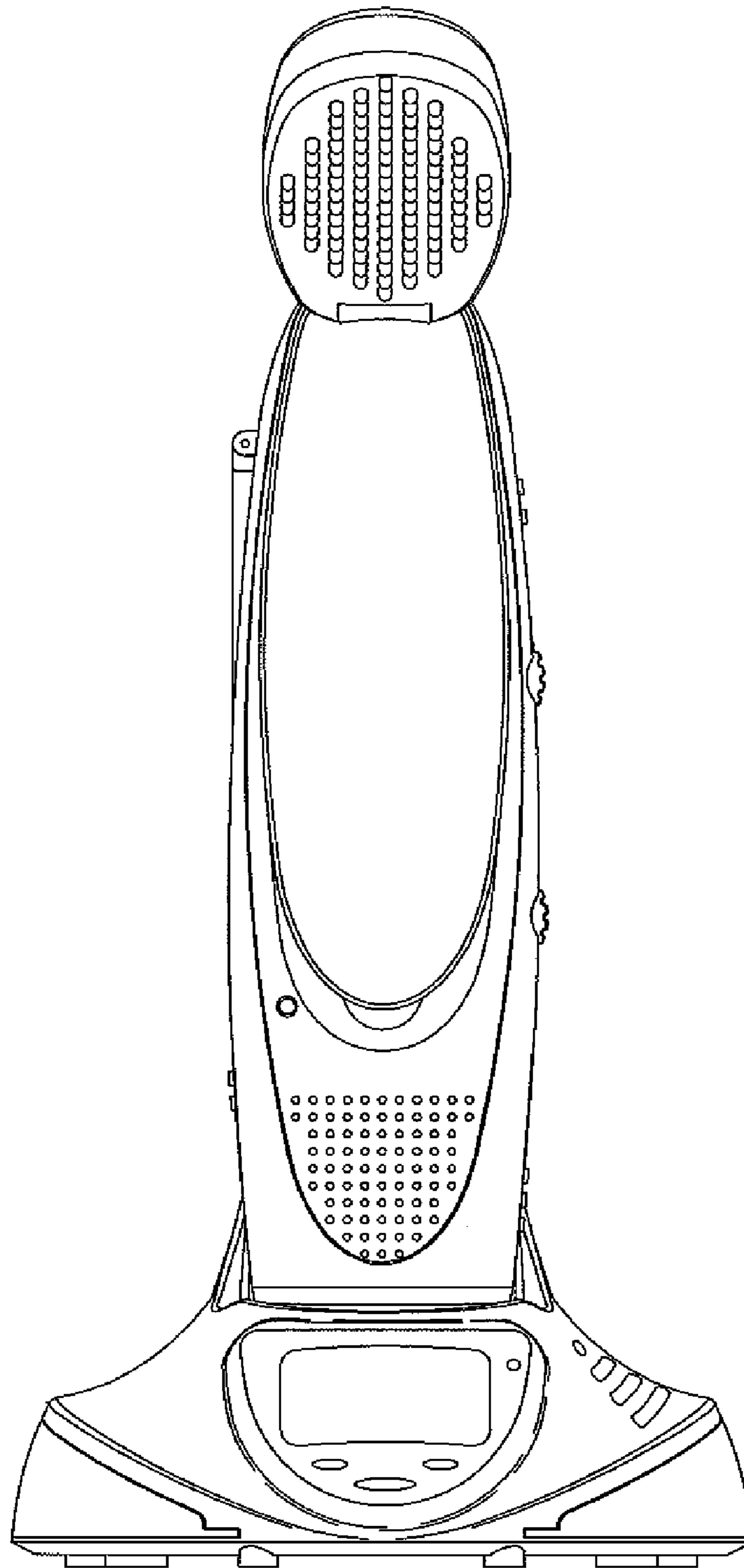

FIG. 2

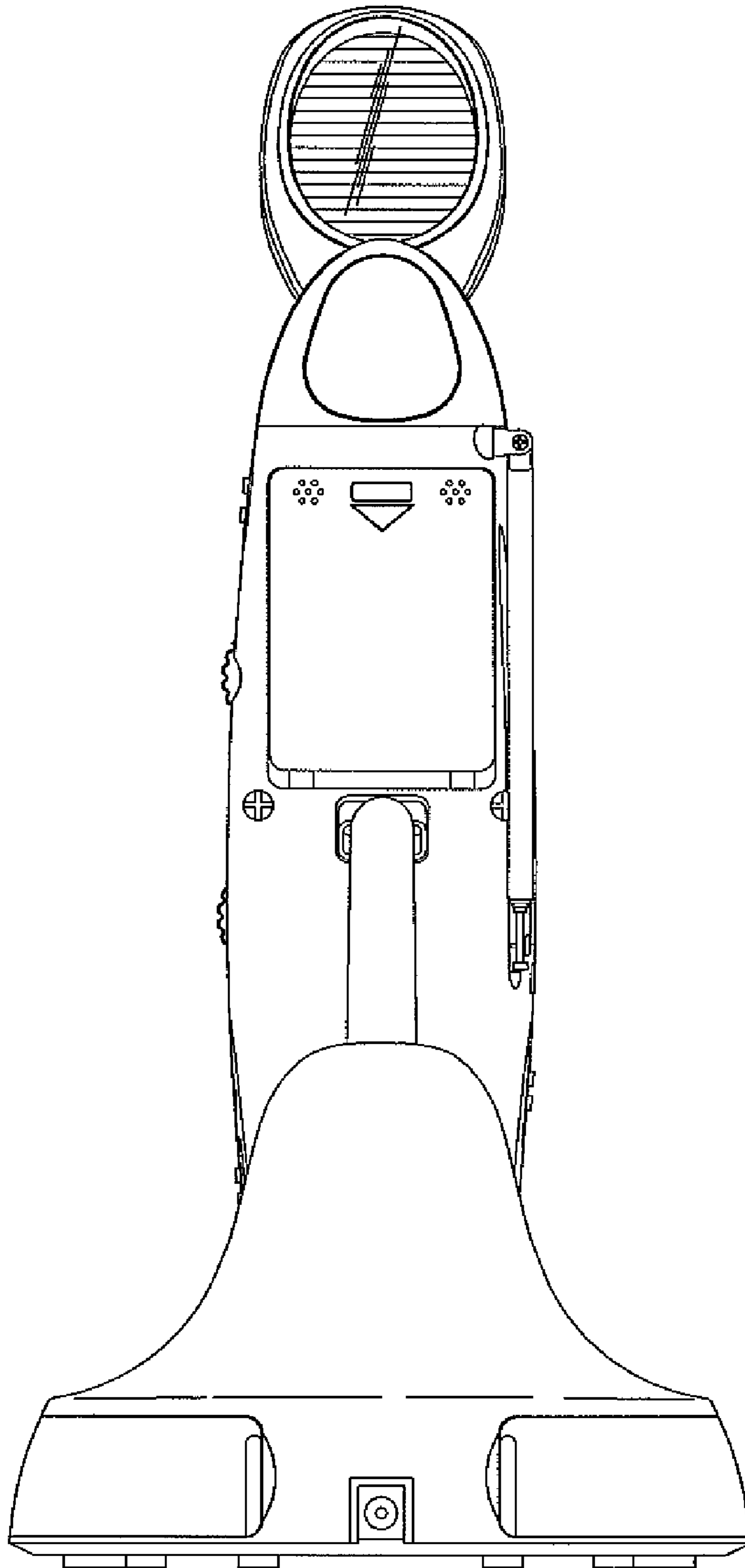

FIG. 3

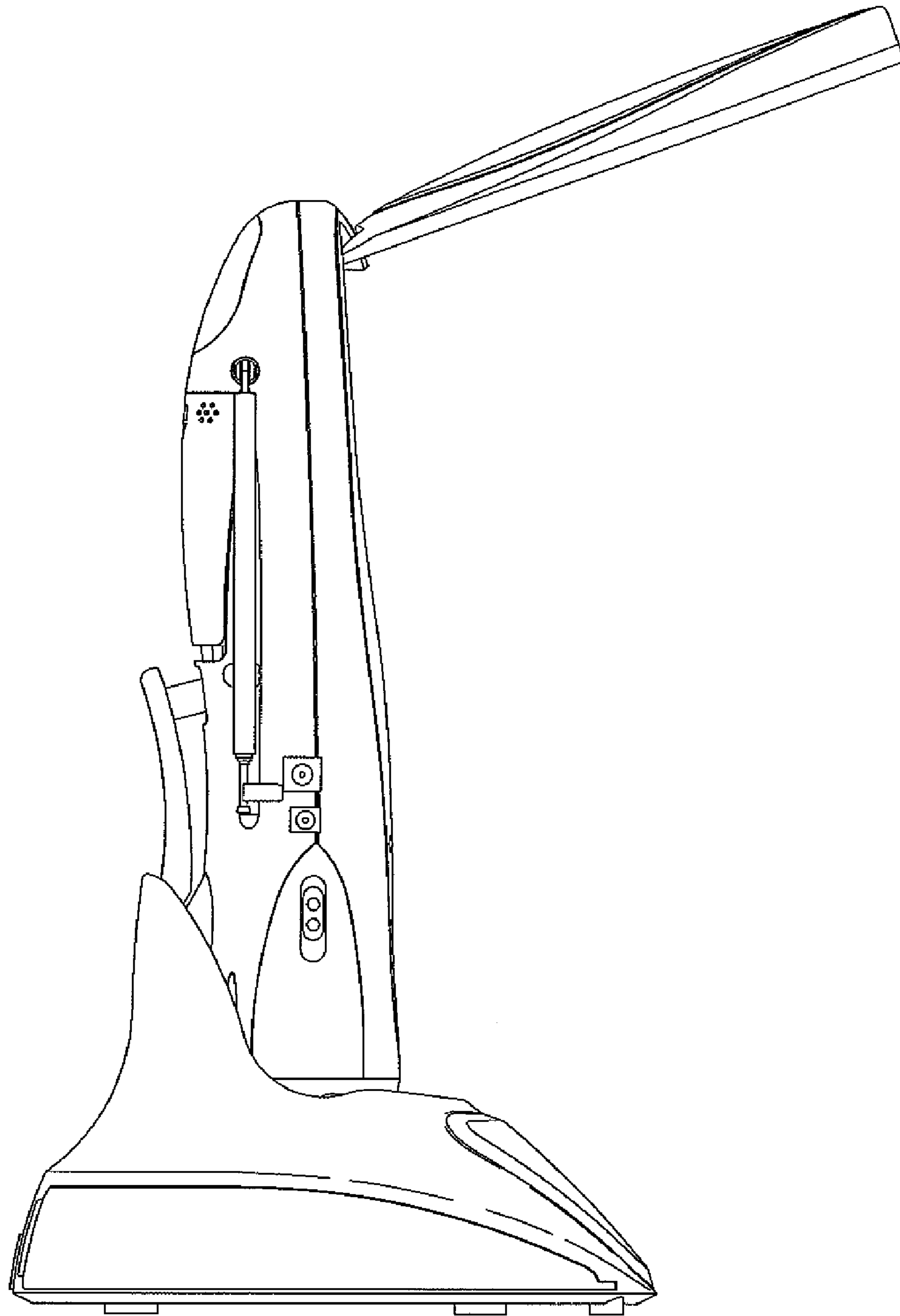

FIG. 4

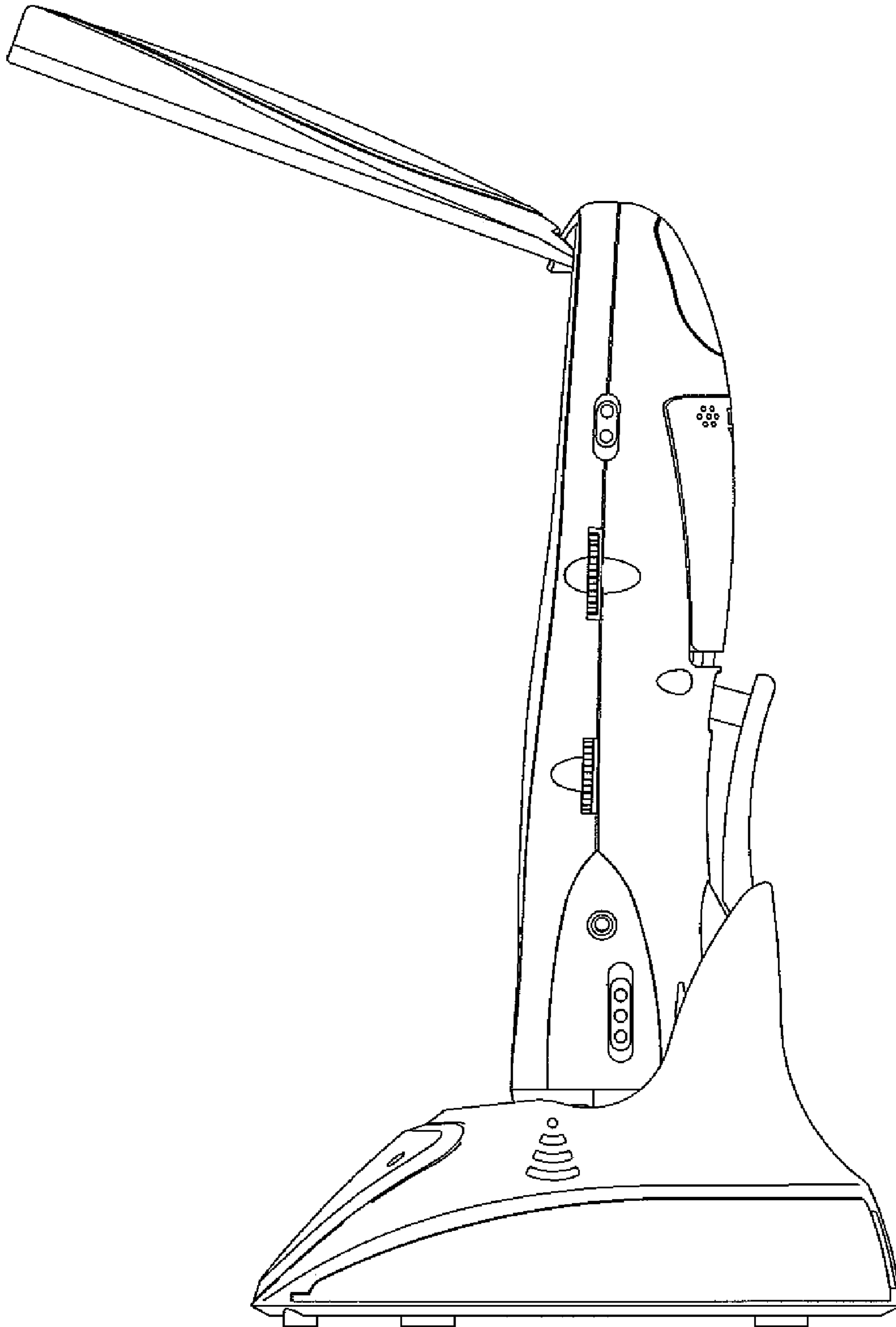

FIG. 5

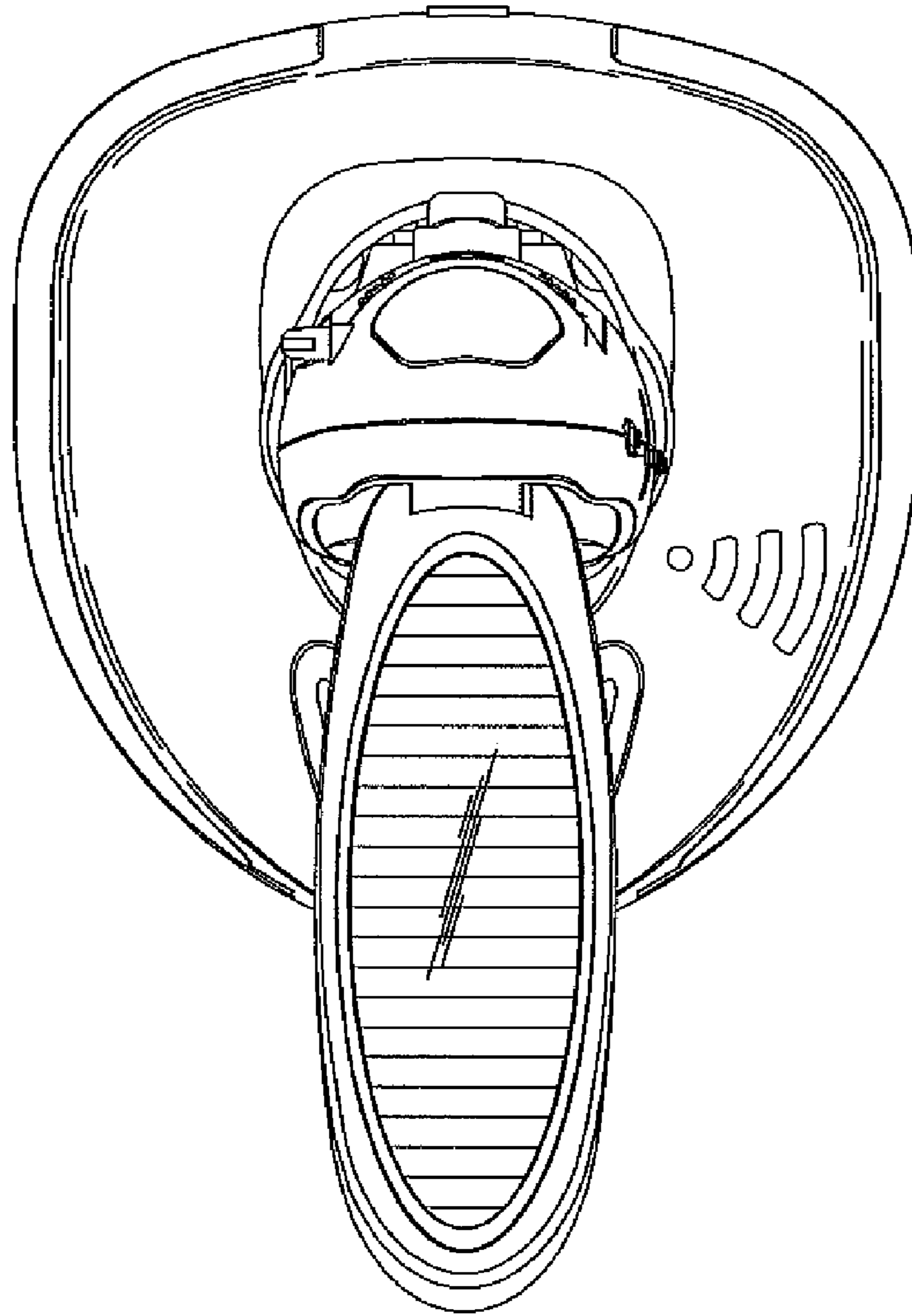

FIG. 6

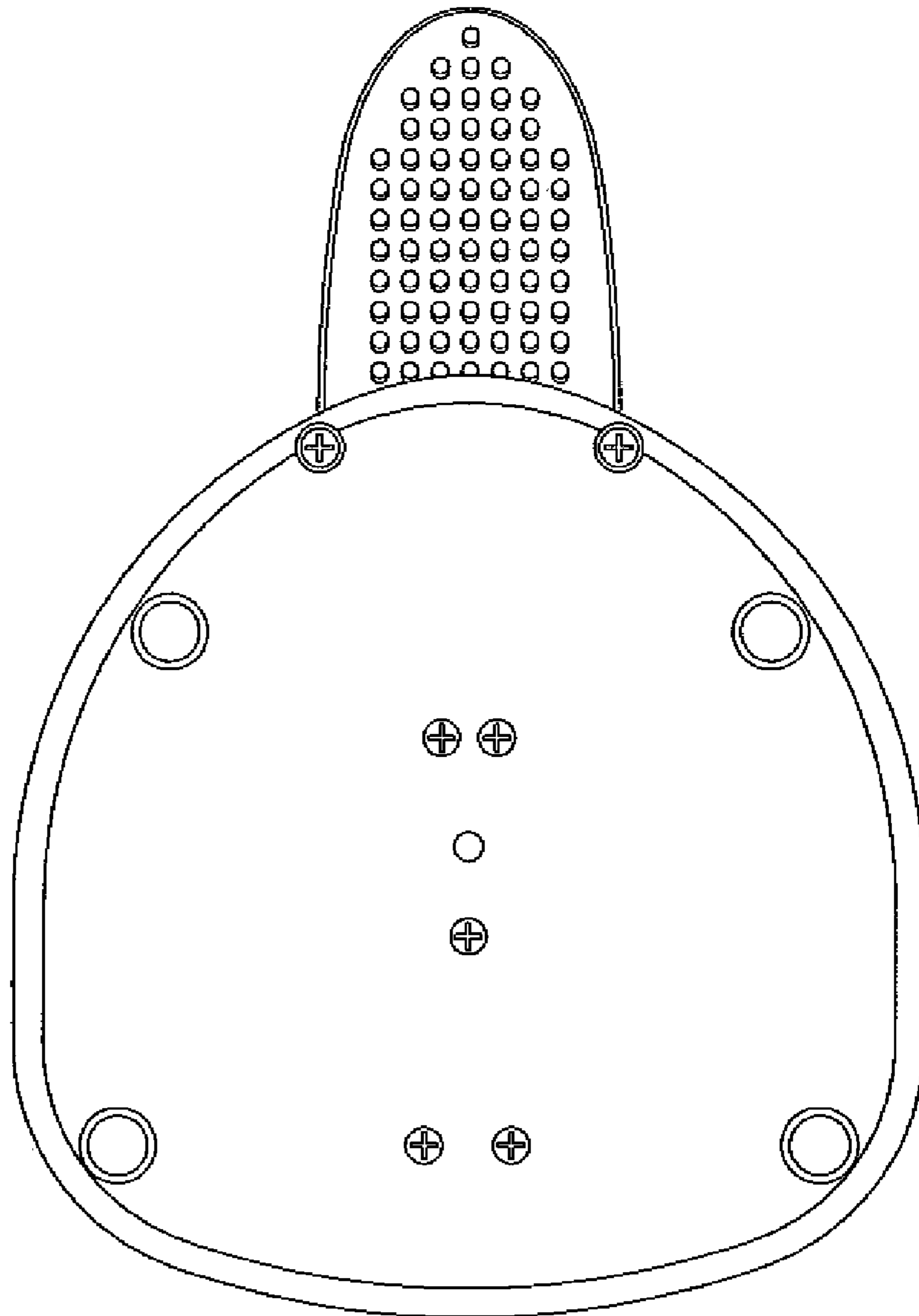

FIG. 7