

US00D570848S

(12) **United States Design Patent**
Deng

(10) **Patent No.:** **US D570,848 S**
(45) **Date of Patent:** **** Jun. 10, 2008**

(54) **FRONT BEZEL FOR COMPUTER ENCLOSURE**

D517,082 S * 3/2006 Zhou et al. D14/444
D522,003 S * 5/2006 Kuang et al. D14/441

(75) Inventor: **Liu-Sha Deng**, Shenzhen (CN)

* cited by examiner

(73) Assignee: **Hon Hai Precision Industry Co., Ltd.**,
Tu-Cheng, Taipei Hsien (TW)

Primary Examiner—Freda S Nunn

(74) *Attorney, Agent, or Firm*—Wei Te Chung

(**) Term: **14 Years**

(57) **CLAIM**

(21) Appl. No.: **29/268,346**

The ornamental design for a front bezel for a computer enclosure, as shown and described.

(22) Filed: **Nov. 3, 2006**

DESCRIPTION

(30) **Foreign Application Priority Data**

Jun. 30, 2006 (CN) 2006 3 0017125

FIG. 1 is a perspective view of a front bezel for a computer enclosure showing my new design;

(51) **LOC (8) Cl.** **14-02**

FIG. 2 is a front elevational view thereof;

(52) **U.S. Cl.** **D14/441**

FIG. 3 is a left side elevational view thereof;

(58) **Field of Classification Search** D14/441–446,

FIG. 4 is a right side elevational view thereof;

D14/308; D13/162, 184, 199; 312/223.2;

FIG. 5 is a top plan view thereof;

361/680–686, 690–696; 369/14, 34.01, 36.01

FIG. 6 is a bottom plan view thereof; and,

See application file for complete search history.

FIG. 7 is a perspective view thereof being mounted to a computer enclosure.

(56) **References Cited**

Broken lines are for illustrative purposes only and form no part of the claimed design.

U.S. PATENT DOCUMENTS

D514,110 S * 1/2006 Liu et al. D14/441

D514,581 S * 2/2006 Zhang et al. D14/446

1 Claim, 5 Drawing Sheets

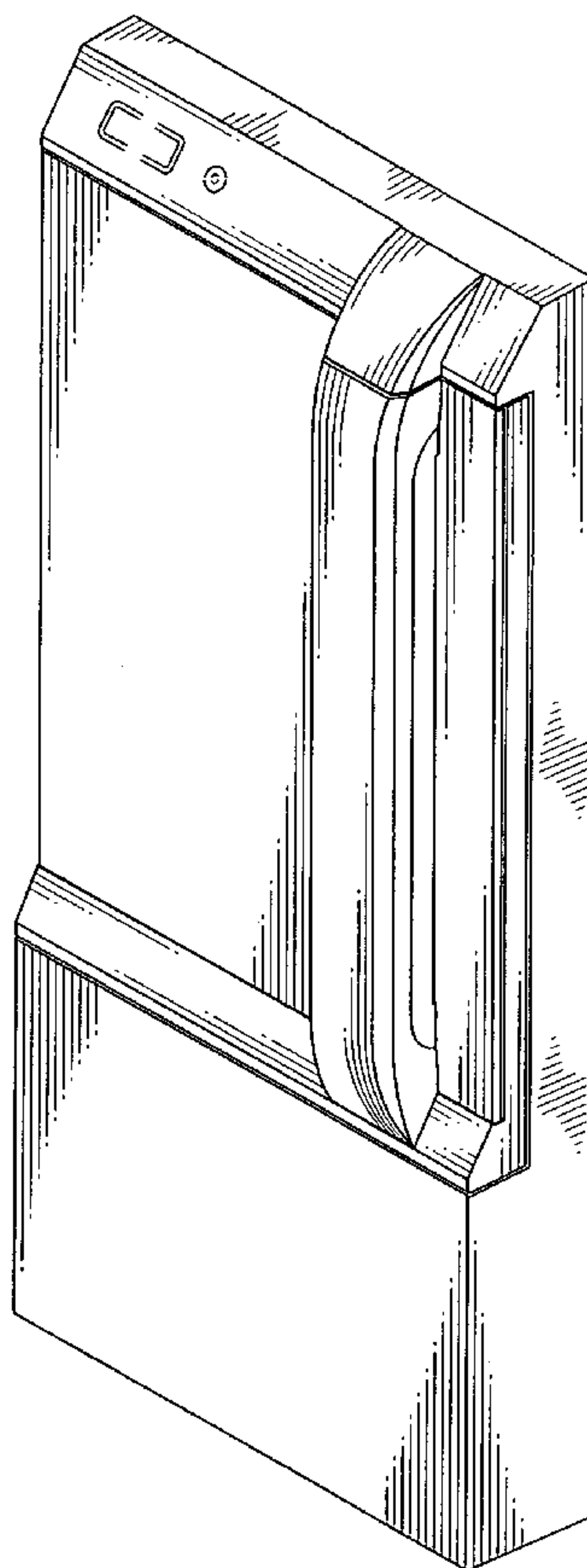

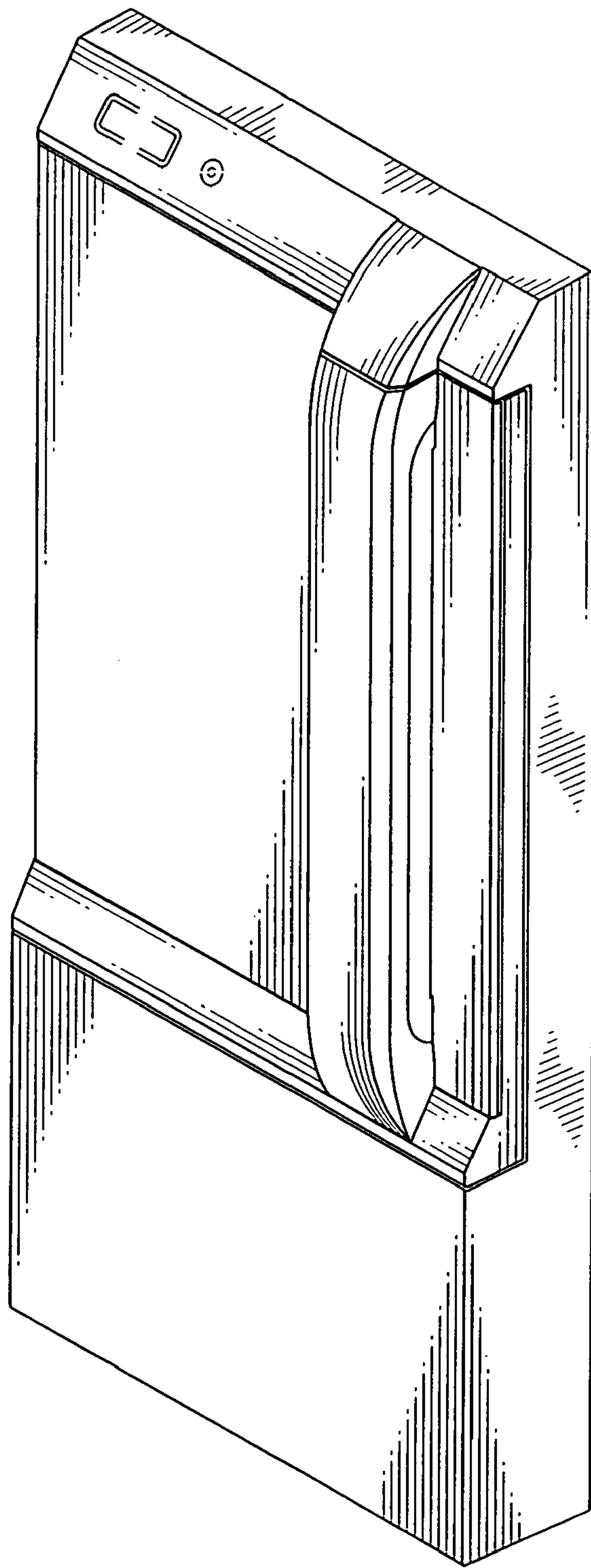

FIG. 1

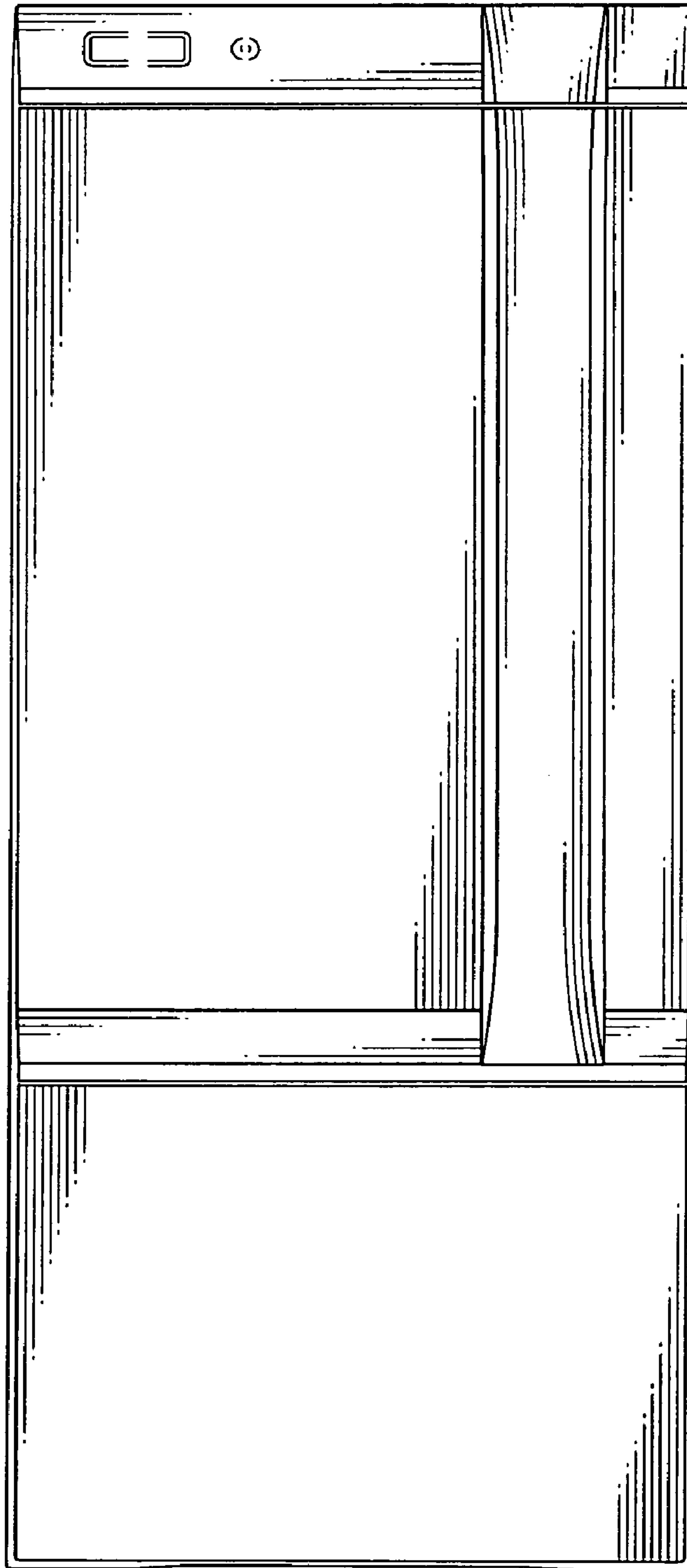

FIG. 2

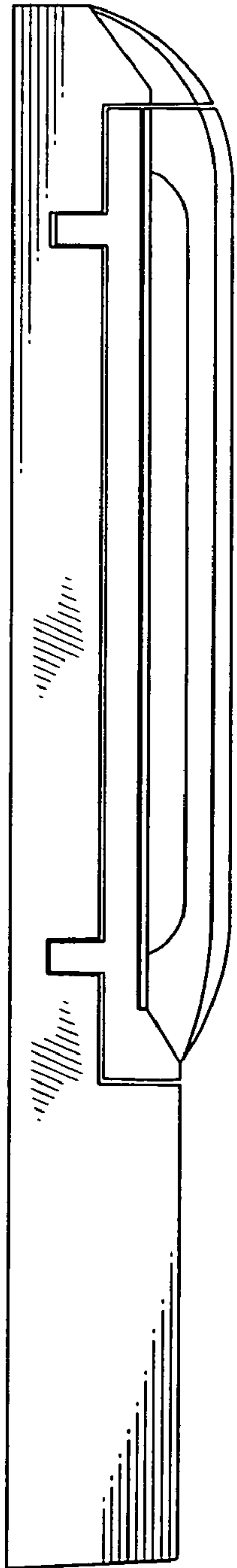

FIG. 3

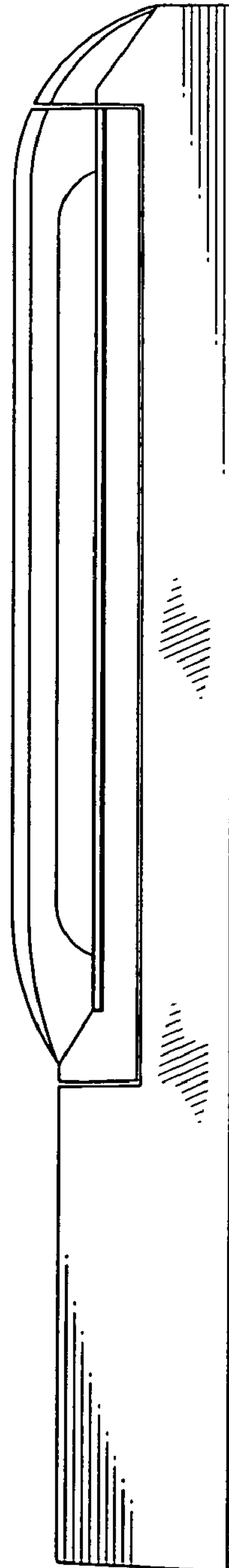

FIG. 4

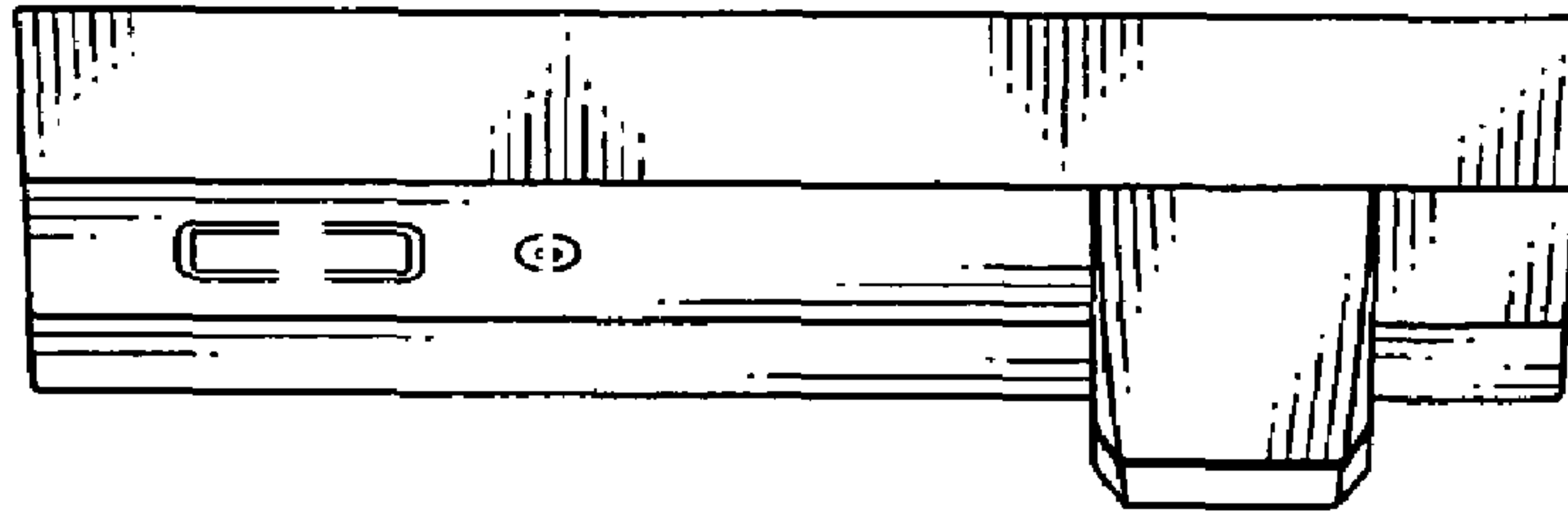

FIG. 5

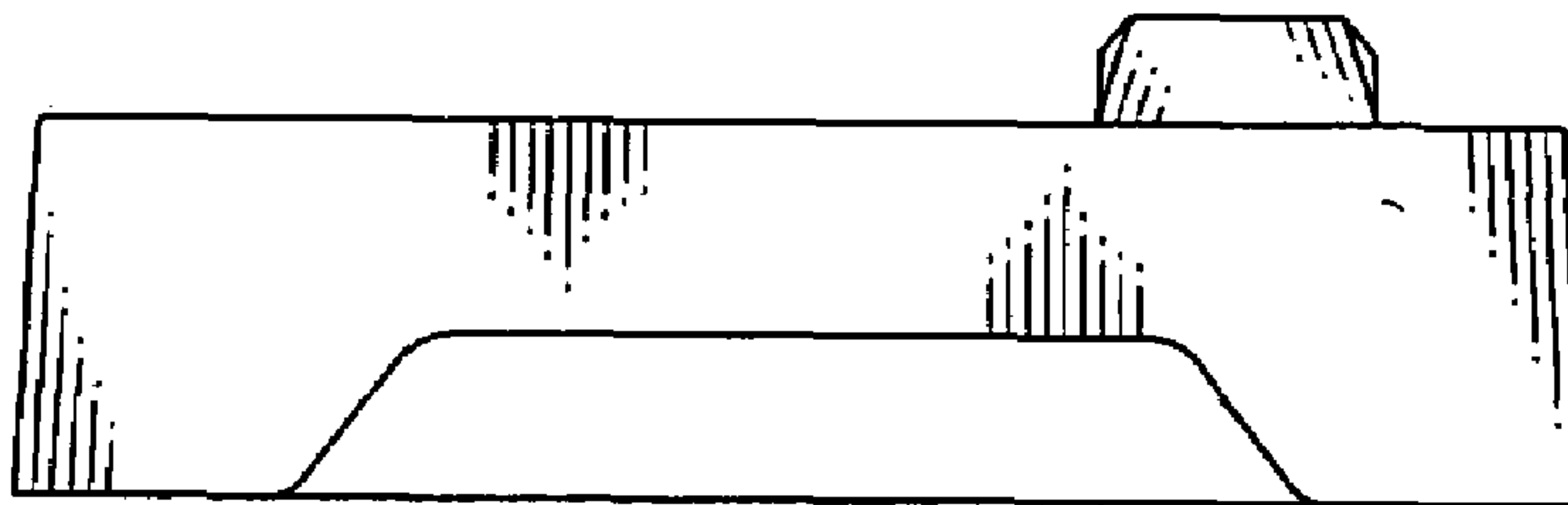

FIG. 6

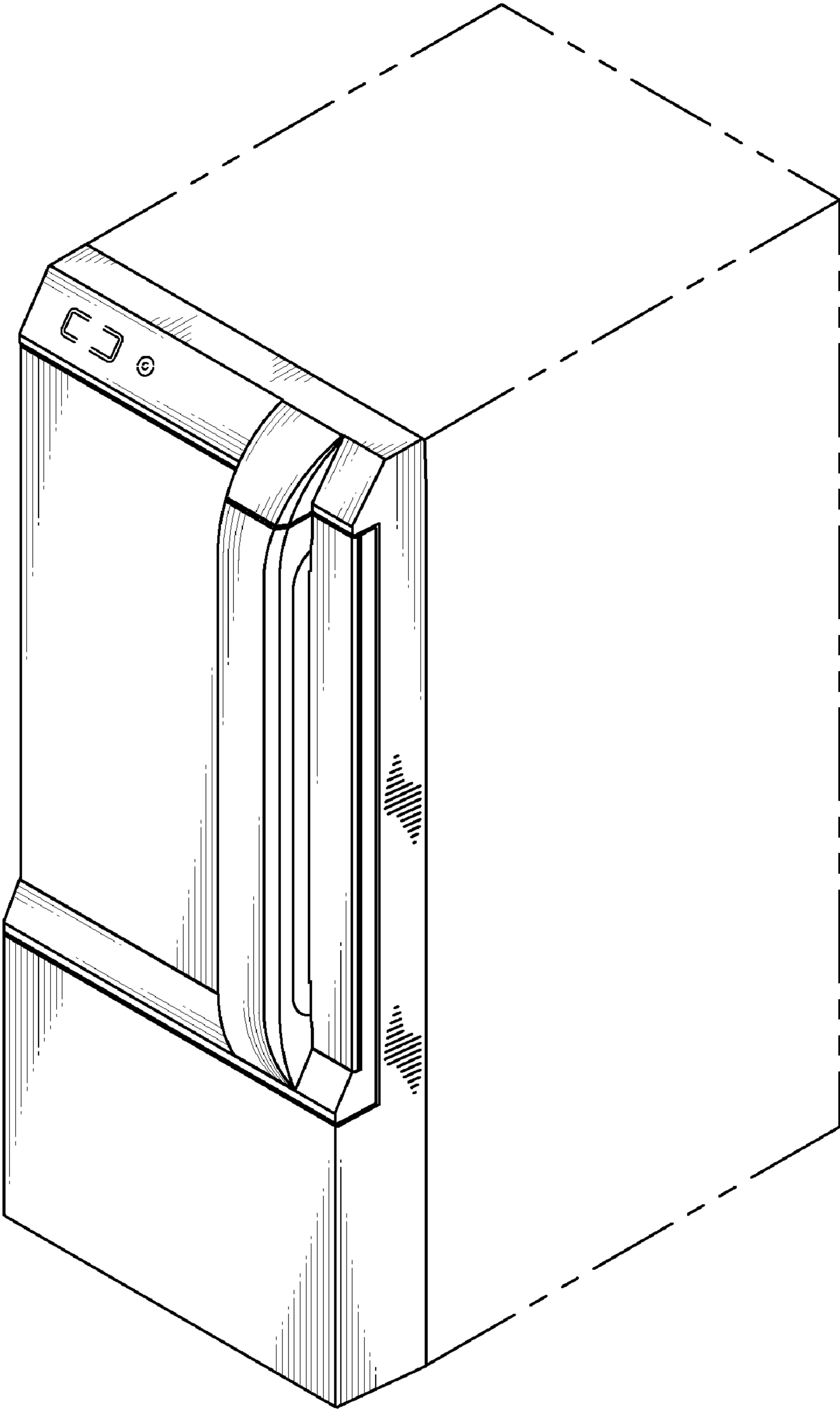

FIG. 7