

US00D570842S

(12) **United States Design Patent**  
**Chatterjee et al.**

(10) **Patent No.:** **US D570,842 S**  
(45) **Date of Patent:** **\*\* Jun. 10, 2008**

(54) **ELECTRONIC MOUSE**

(74) *Attorney, Agent, or Firm*—Banner & Witcoff, Ltd.

(75) Inventors: **Monique Chatterjee**, Seattle, WA (US);  
**Allen M. Han**, Snoqualmie, WA (US)

(57) **CLAIM**

The ornamental design for an electronic mouse, as shown and described.

(73) Assignee: **Microsoft Corporation**, Redmond, WA (US)

(\*\*) Term: **14 Years**

**DESCRIPTION**

(21) Appl. No.: **29/279,530**

FIG. 1 is a rear perspective view of an electronic mouse showing our new design;

(22) Filed: **May 2, 2007**

FIG. 2 is a front perspective view thereof;

(51) **LOC (8) Cl.** ..... **14-02**

FIG. 3 is a front view thereof;

(52) **U.S. Cl.** ..... **D14/402**

FIG. 4 is a rear view thereof;

(58) **Field of Classification Search** ..... D14/402–410,  
D14/417; 235/472.01; 345/156–157; 365/49;  
200/5 A, 5 R, 6 A, 6 R; 273/148 B  
See application file for complete search history.

FIG. 5 is a left side view thereof;

FIG. 6 is a right side view thereof; and

FIG. 7 is a top view thereof;

FIG. 8 is a rear perspective view of an alternate embodiment of an electronic mouse showing our new design;

(56) **References Cited**

FIG. 9 is a front perspective view thereof;

**U.S. PATENT DOCUMENTS**

FIG. 10 is a front view thereof;

D460,072 S *	7/2002	Sheehan	.....	D14/408
D464,652 S *	10/2002	Roh	.....	D14/408
D467,925 S *	12/2002	Hu et al.	.....	D14/408
D474,769 S *	5/2003	Fisher et al.	.....	D14/408
D488,157 S *	4/2004	Fisher	.....	D14/408
D491,946 S *	6/2004	Slocombe et al.	.....	D14/402
D504,133 S *	4/2005	Canavan et al.	.....	D14/402
D514,106 S *	1/2006	Pan	.....	D14/408
D528,118 S *	9/2006	Canavan et al.	.....	D14/407

FIG. 11 is a rear view thereof;

FIG. 12 is a left side view thereof;

FIG. 13 is a right side view thereof;

FIG. 14 is a top view thereof; and,

FIG. 15 is a bottom view thereof.

The broken line showing of various regions in FIGS. 1–7 and the unshaded areas therein is for illustrative purposes only and forms no part of the claimed design.

\* cited by examiner

*Primary Examiner*—Pamela J. Burgess

**1 Claim, 9 Drawing Sheets**

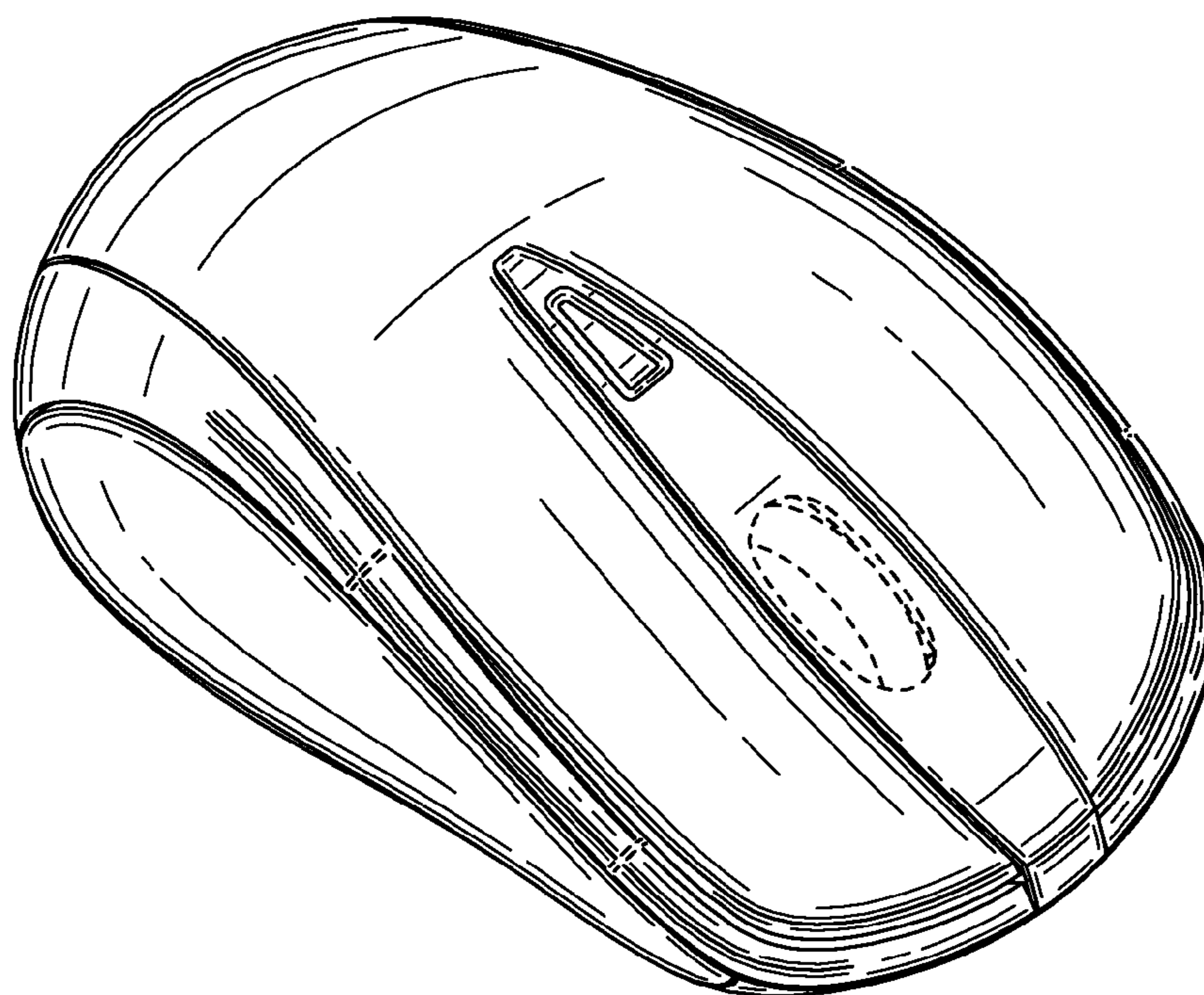

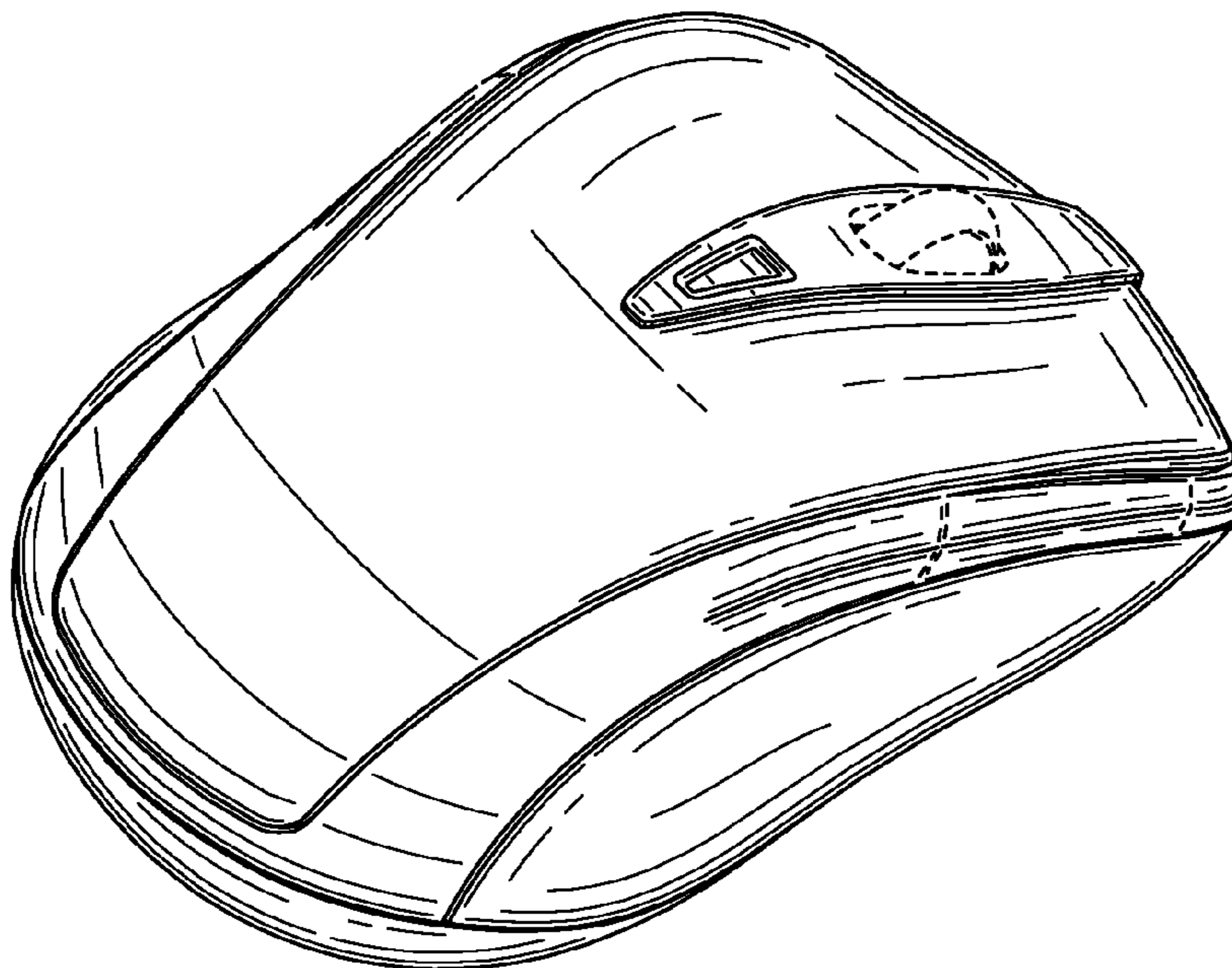

FIG. 1

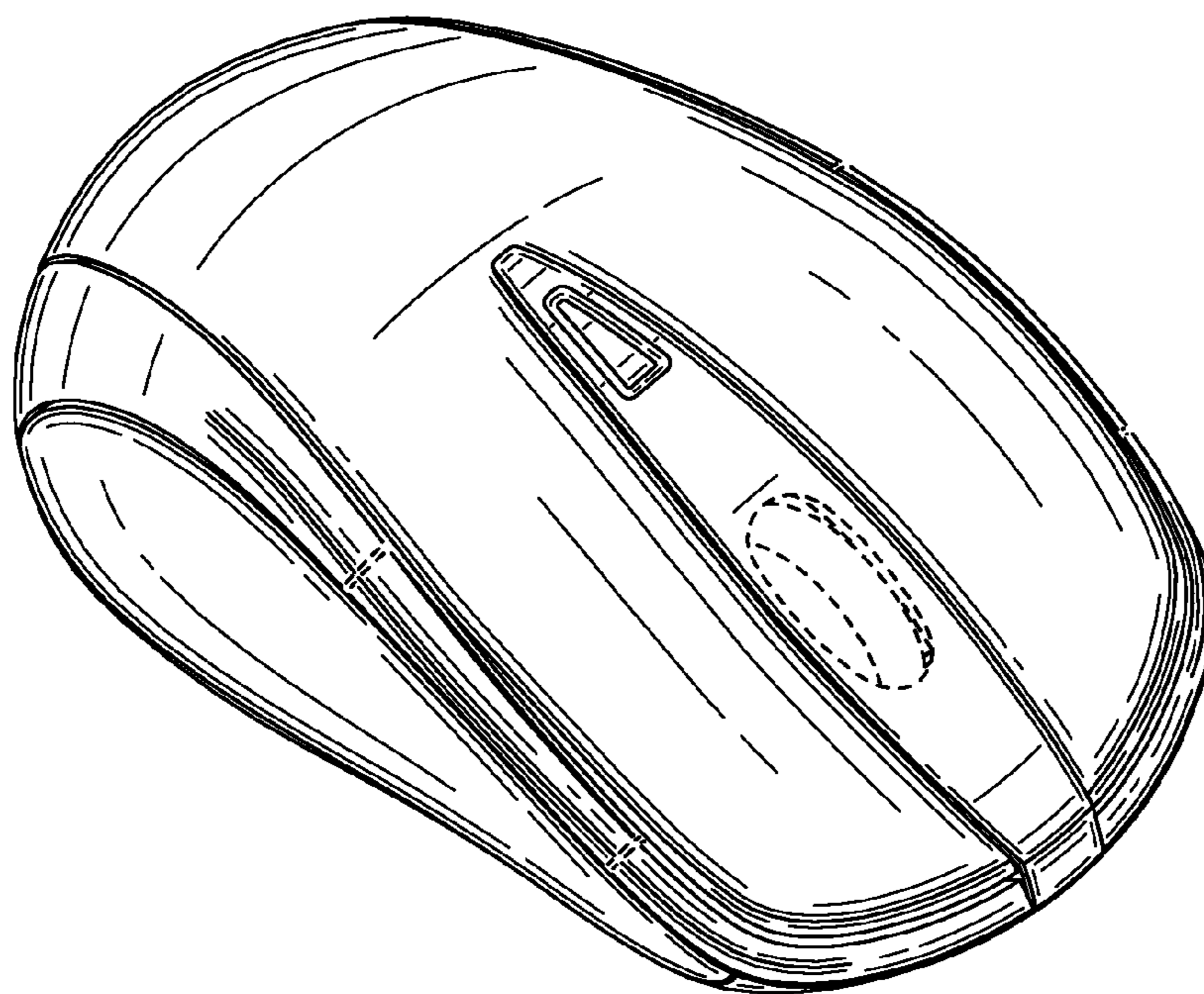

FIG. 2

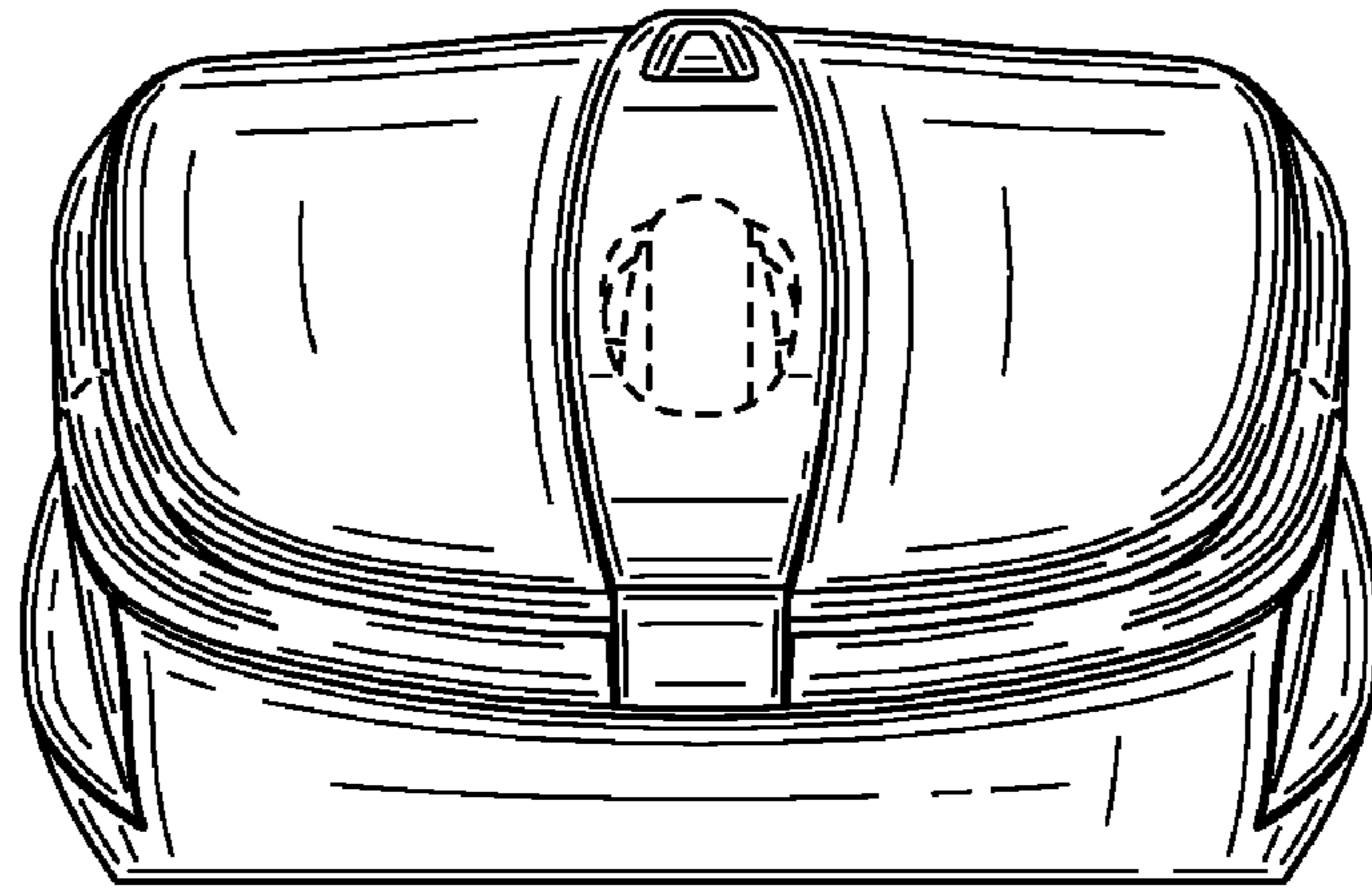

FIG. 3

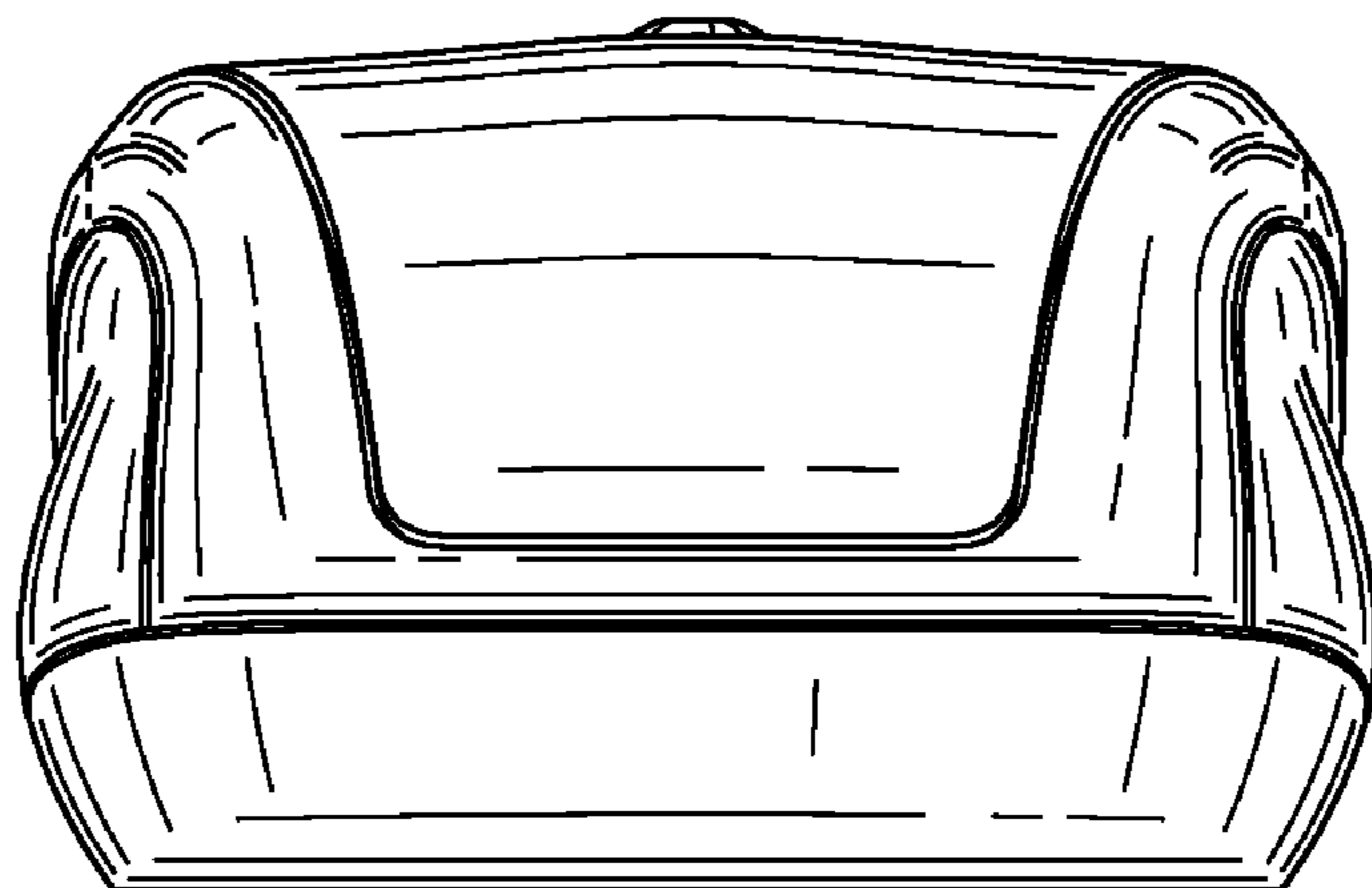

FIG. 4

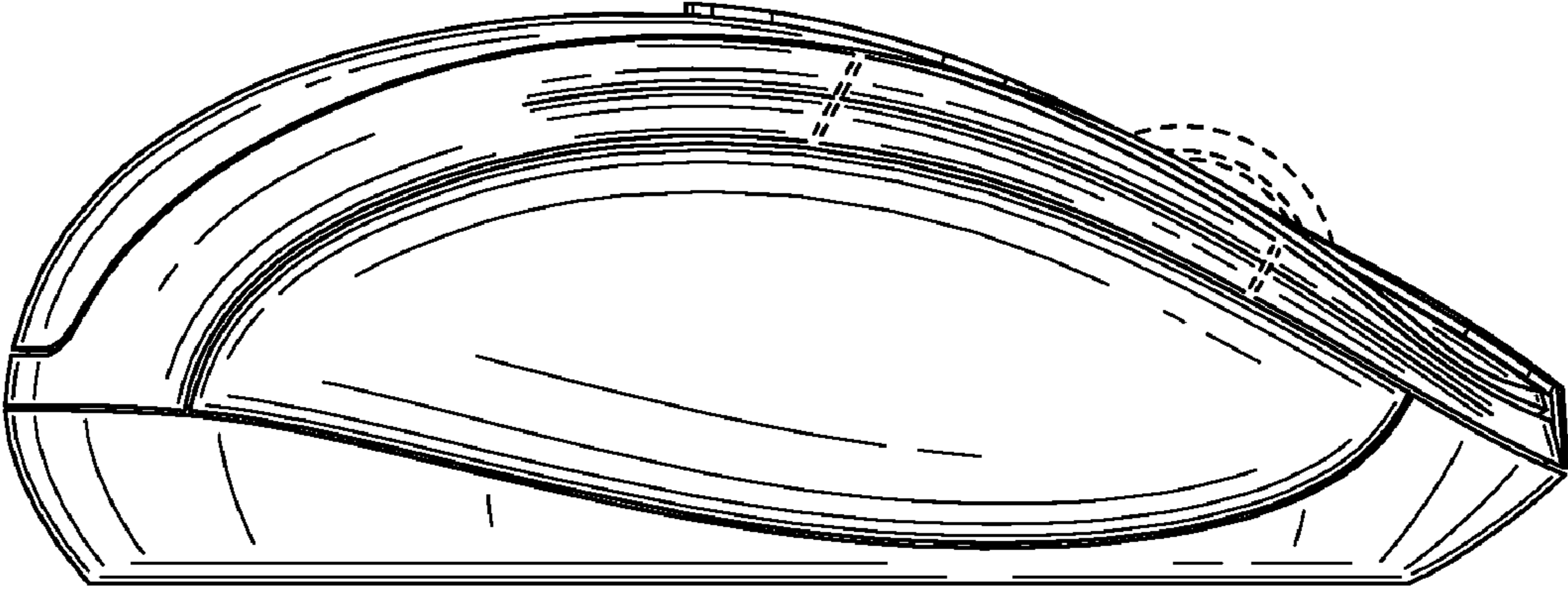

FIG. 5

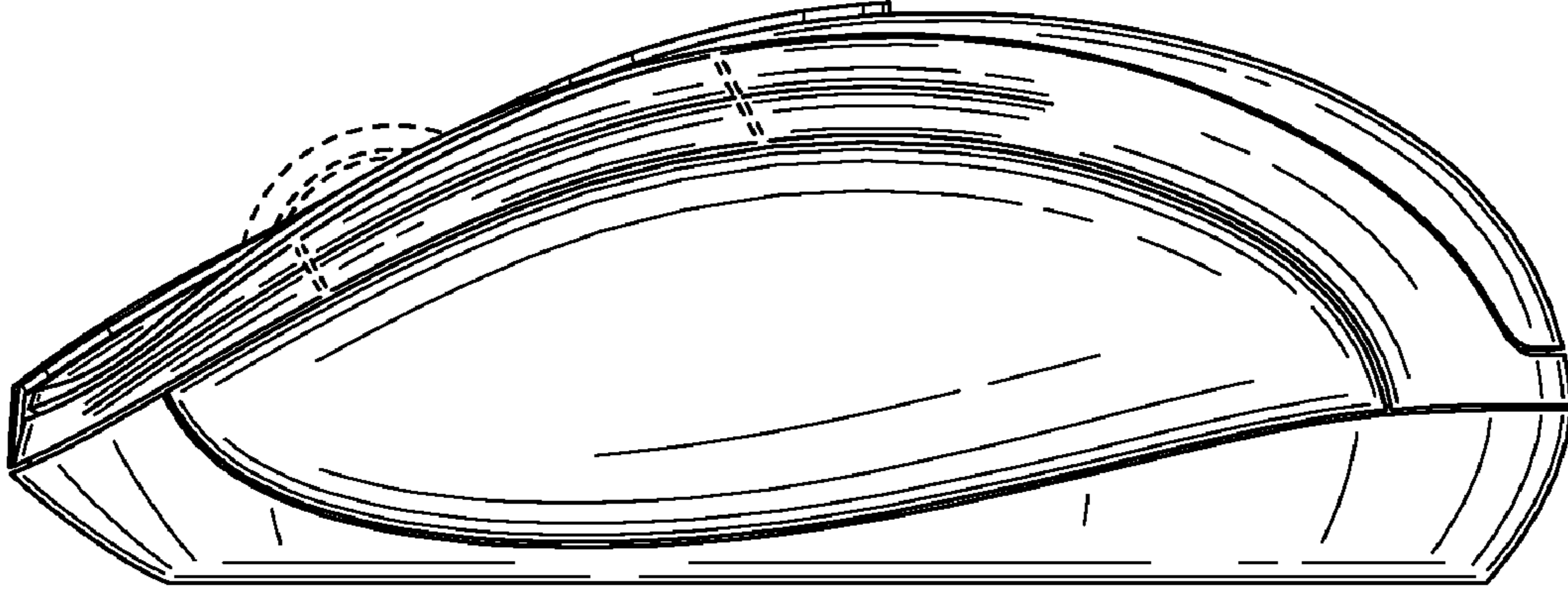

FIG. 6

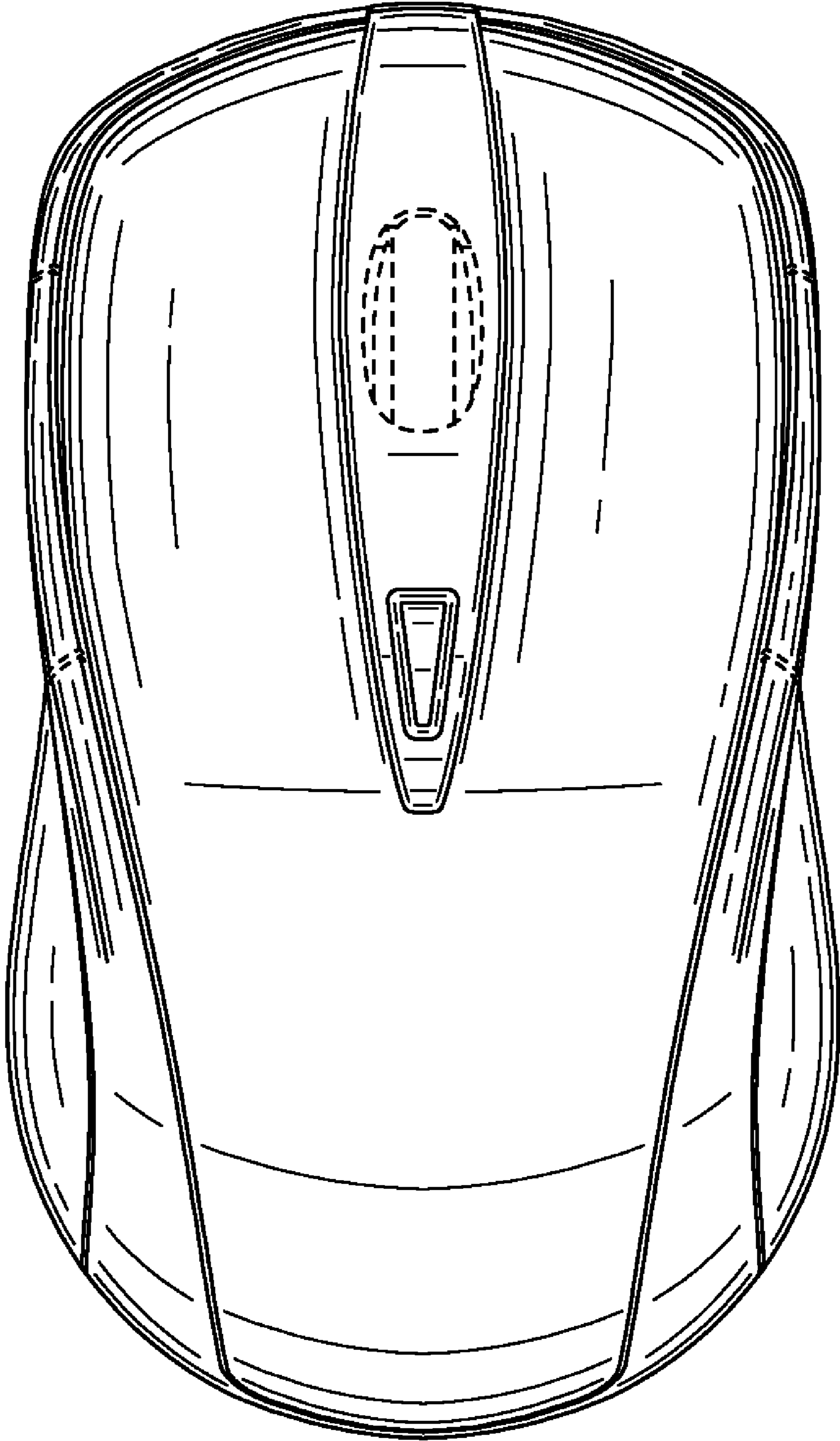

FIG. 7

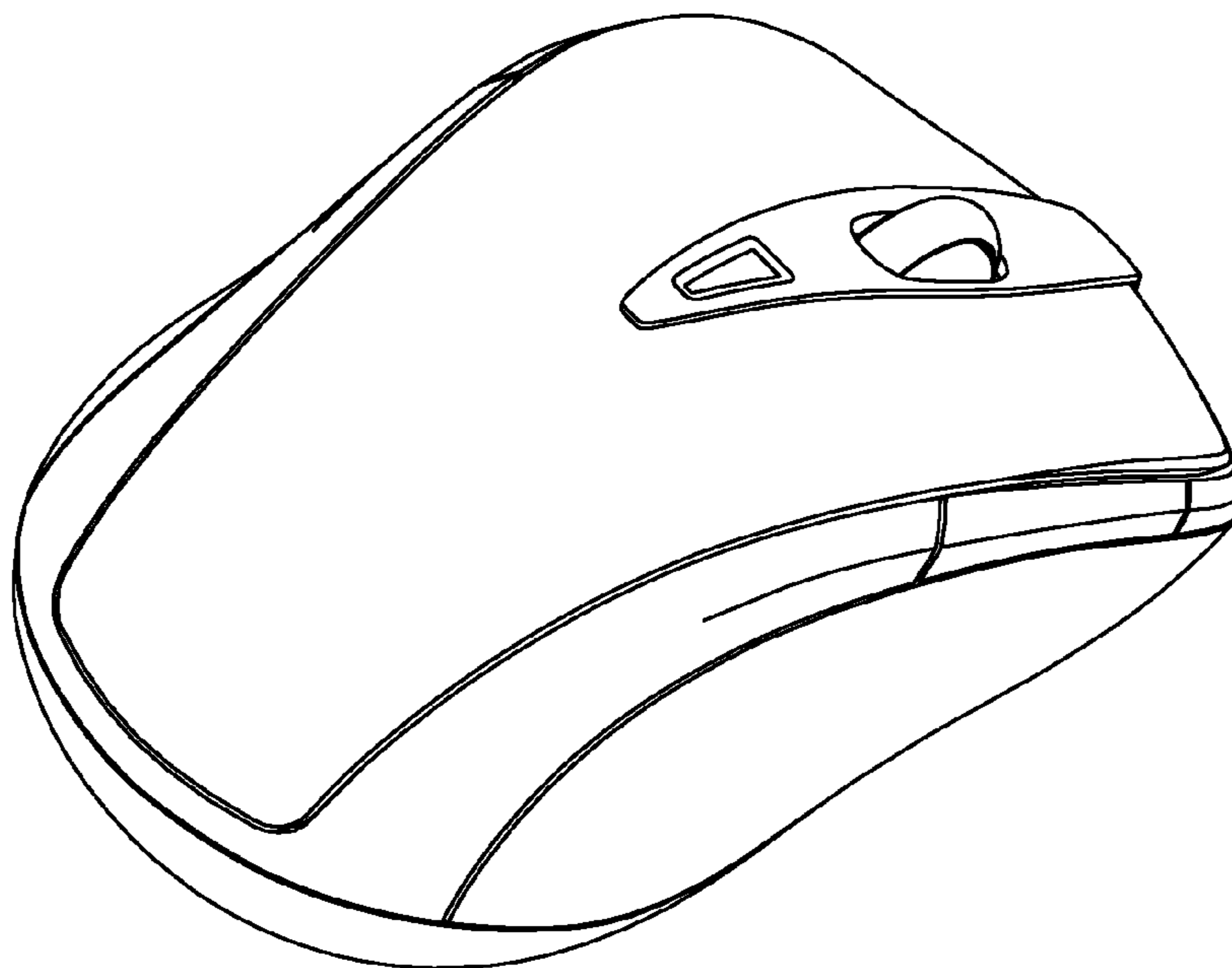

FIG. 8

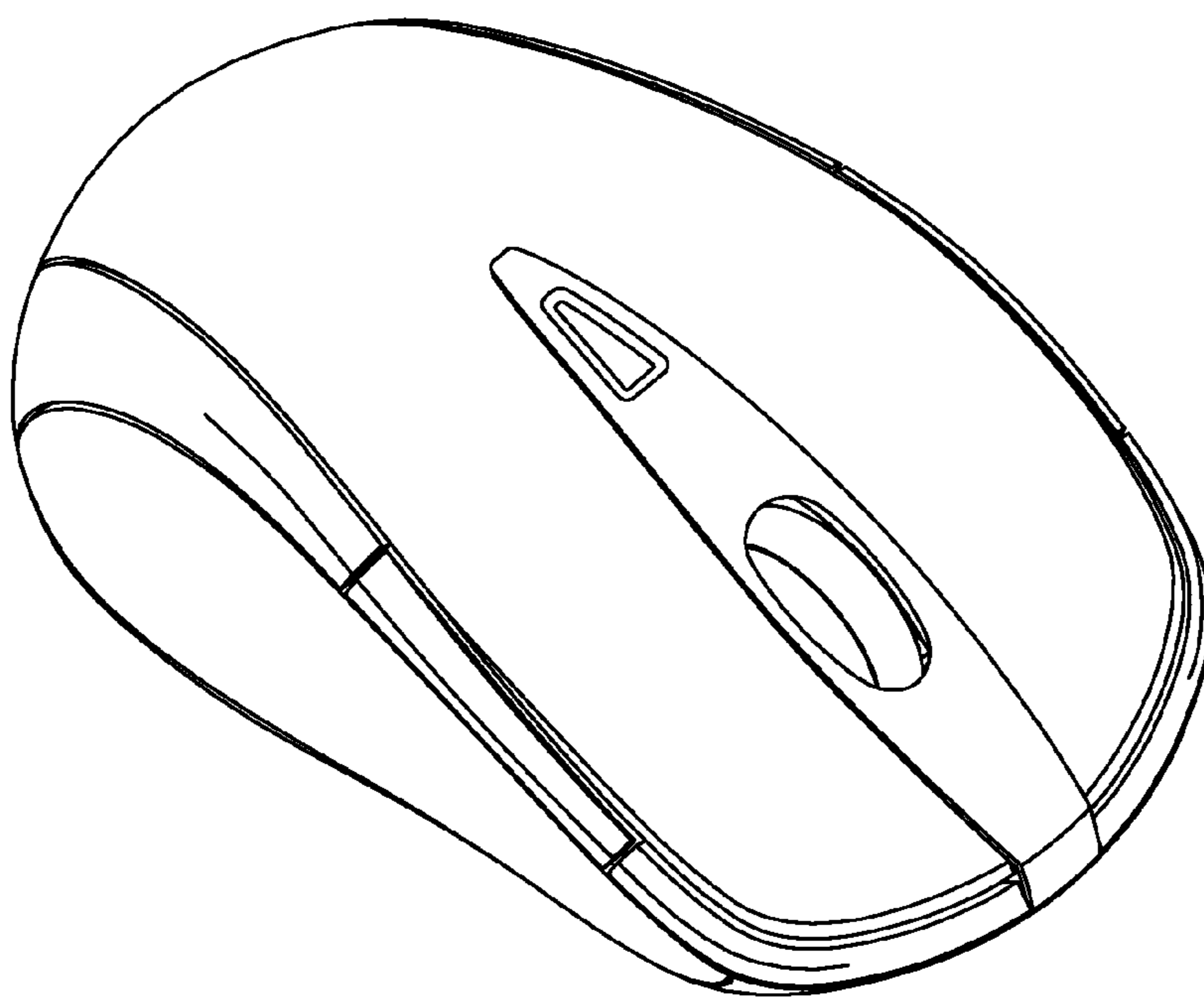

FIG. 9

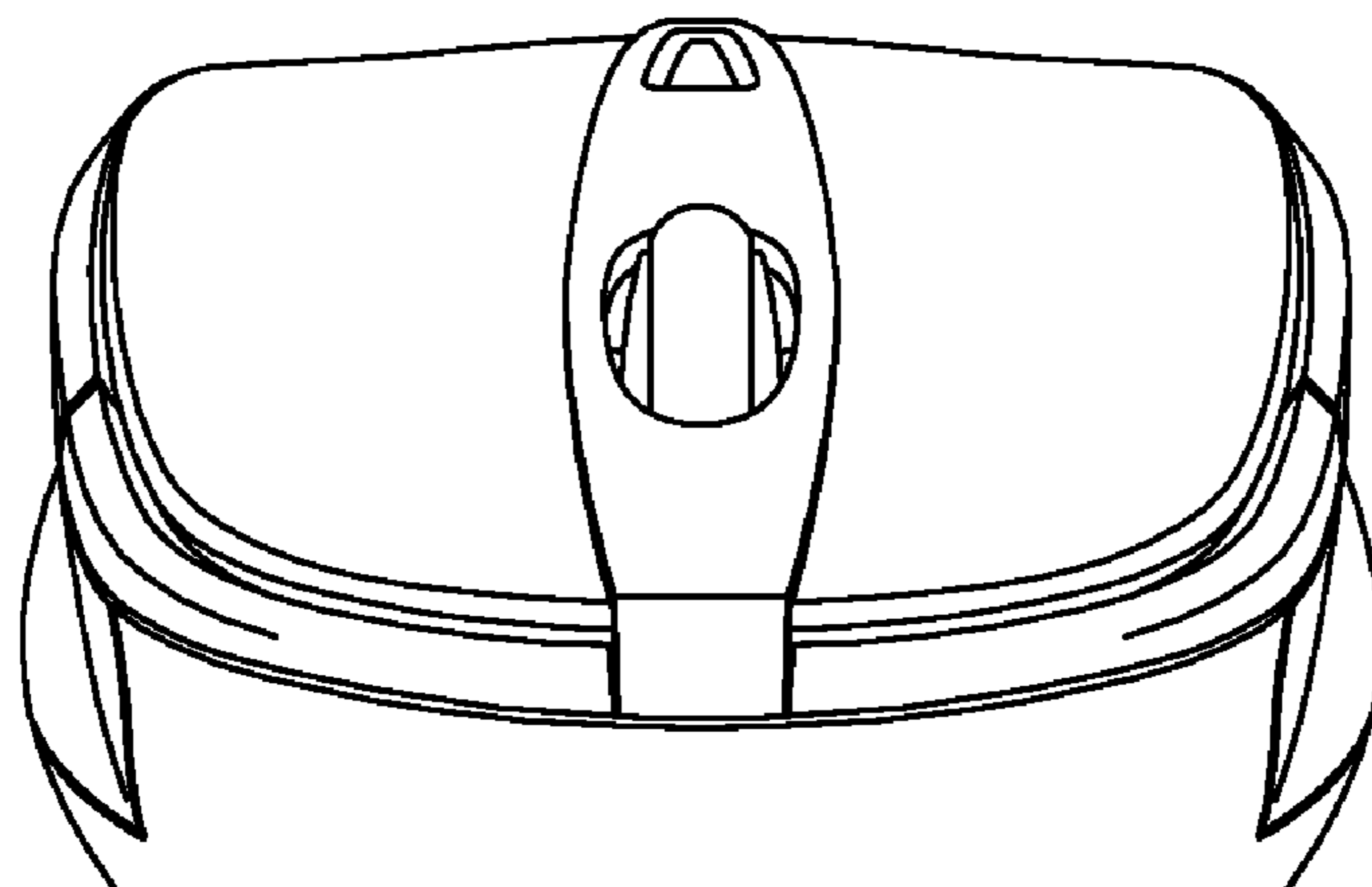

FIG. 10

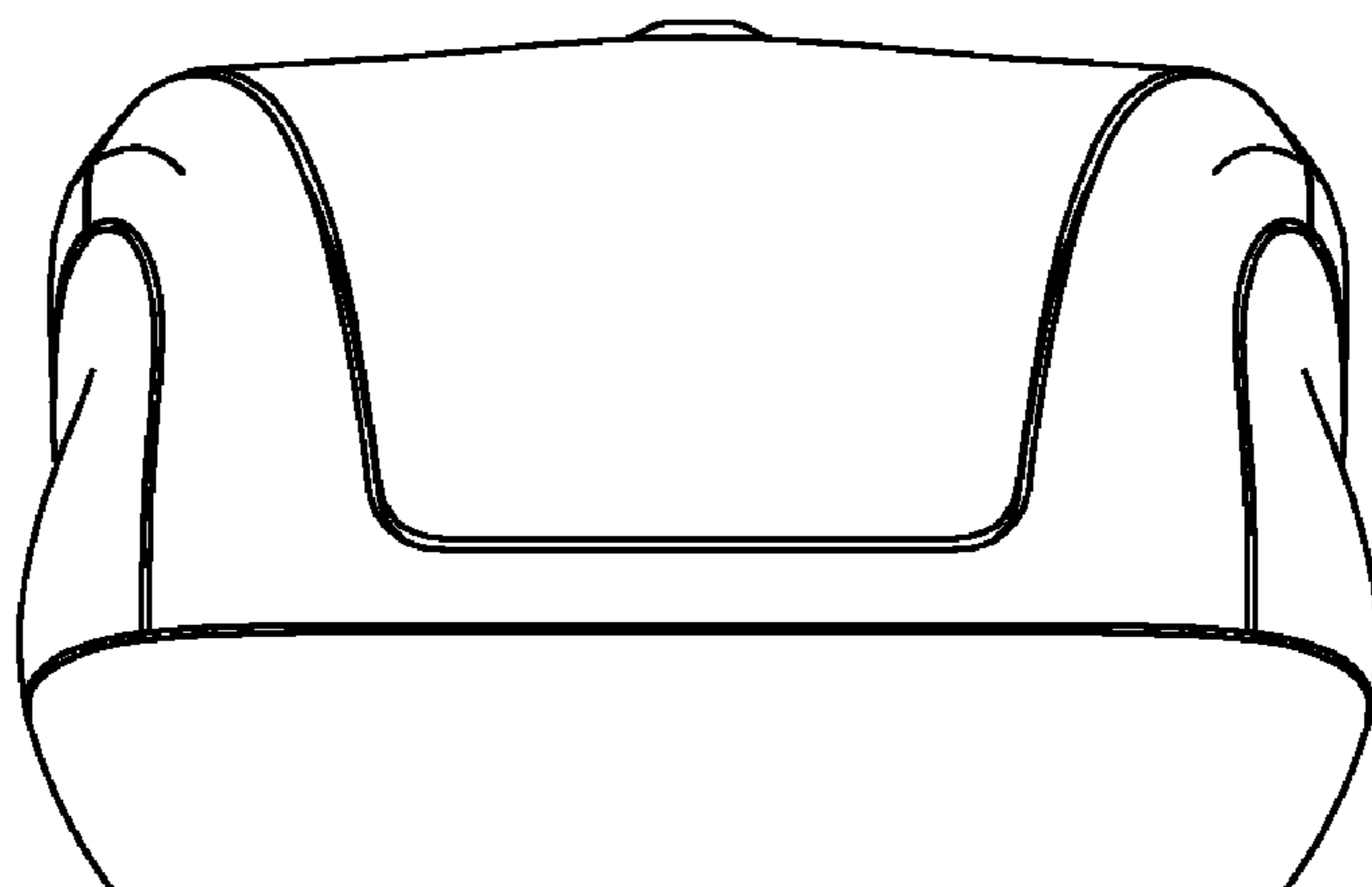

FIG. 11

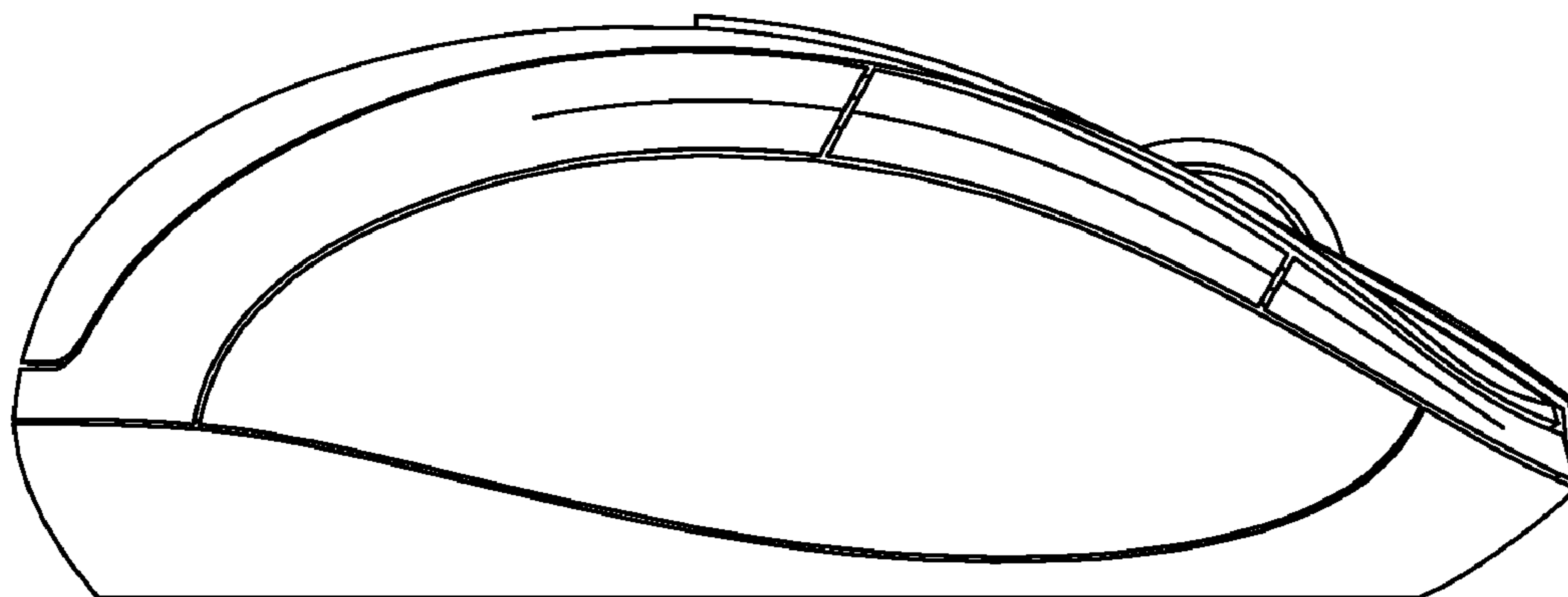

FIG. 12

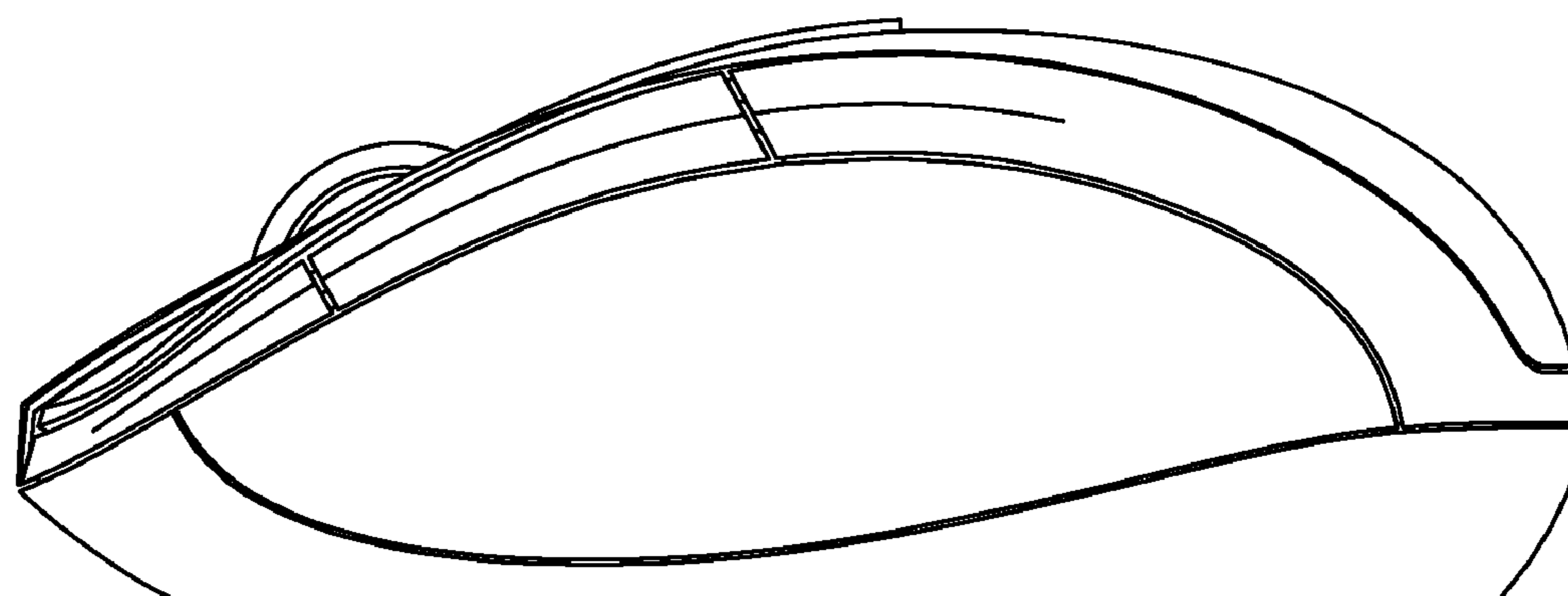

FIG. 13



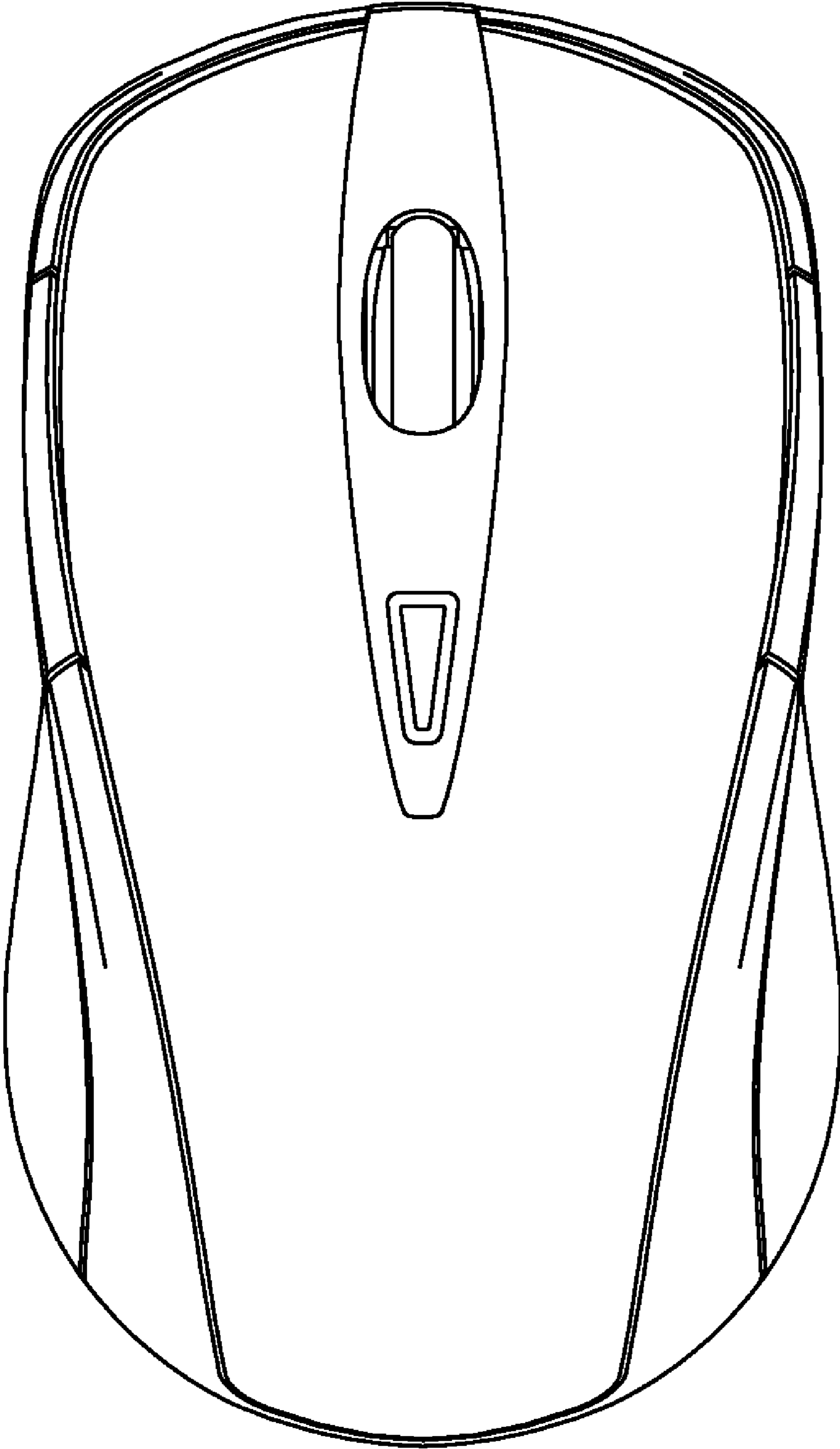

FIG. 14

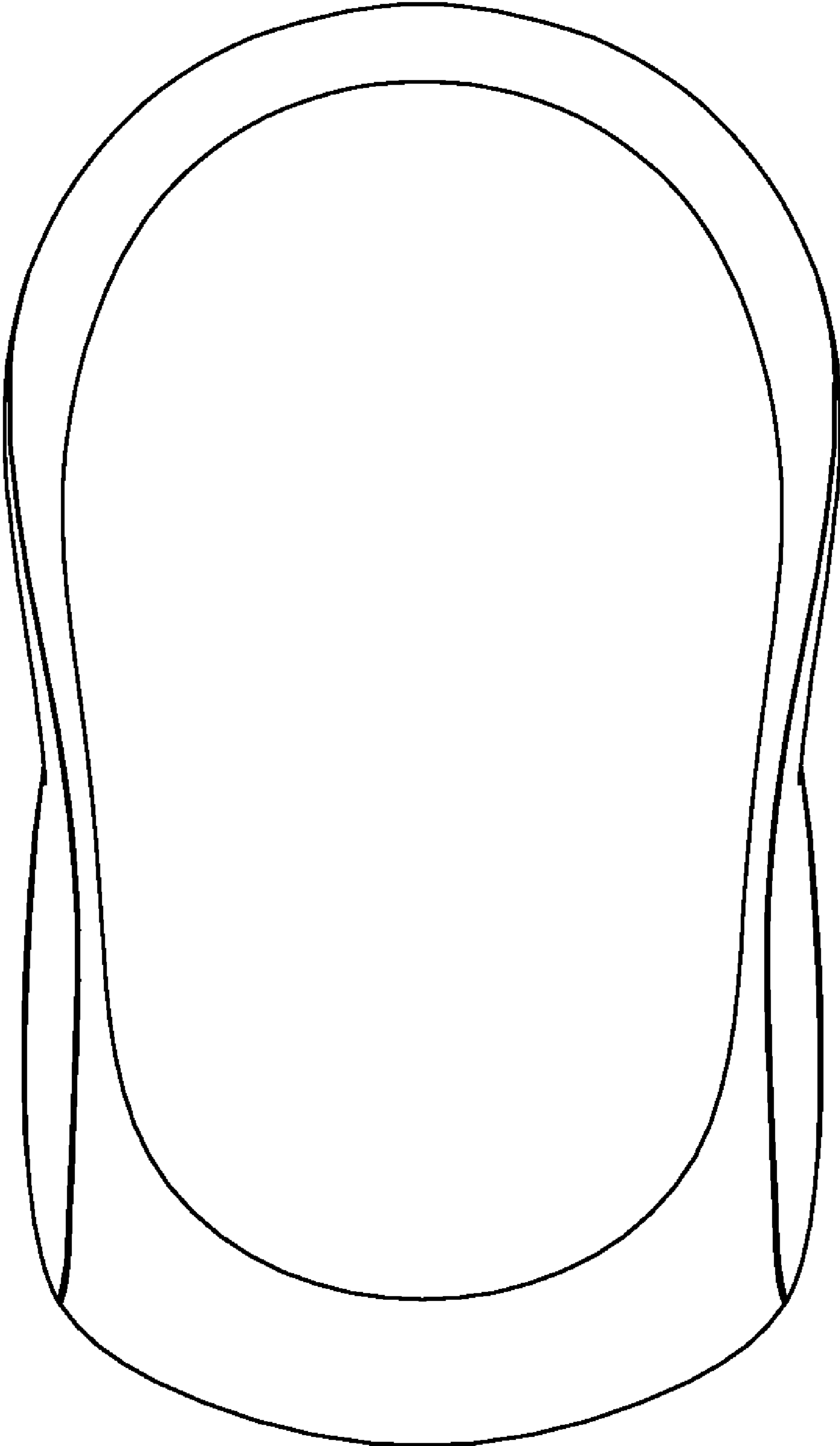

FIG. 15