



US00D570840S

(12) **United States Design Patent**
Rak et al.

(10) **Patent No.:** **US D570,840 S**
(45) **Date of Patent:** **** Jun. 10, 2008**

(54) **HANDHELD DEVICE**
(75) Inventors: **Roman P. Rak**, Waterloo (CA); **Jason T. Griffin**, Kitchener (CA)

D561,764 S * 2/2008 Griffin et al. D14/439
D562,312 S * 2/2008 Hu et al. D14/248
D562,828 S * 2/2008 Griffin et al. D14/439
D563,378 S * 3/2008 Tseng et al. D14/138
D563,415 S * 3/2008 Griffin et al. D14/439

(73) Assignee: **Research In Motion Limited**,
Waterloo, Ontario (CA)

* cited by examiner

(**) Term: **14 Years**

Primary Examiner—Cathron Brooks

Assistant Examiner—Angela J Lee

(21) Appl. No.: **29/279,312**

(74) *Attorney, Agent, or Firm*—Brij K. Agarwal; Eckert
Seamans Cherin & Mellott, LLC

(22) Filed: **Apr. 26, 2007**

(57) **CLAIM**

(51) **LOC (8) Cl.** **14-02**

The ornamental design for a handheld device, as shown and described.

(52) **U.S. Cl.** **D14/346**

(58) **Field of Classification Search** D14/346,
D14/341, 342, 343, 344, 345, 347, 439, 137,
D14/138, 374, 248, 496, 125, 129; 345/169,
345/173; 379/433.04, 433.06, 433.07, 433.11,
379/433.12, 433.13; 348/14.02; 455/556.1,
455/556.2, 566, 575.1, 575.3, 575.4, 90.3;
341/22; D13/168; D18/6, 7; D21/329,
D21/331

See application file for complete search history.

DESCRIPTION

(56) **References Cited**

U.S. PATENT DOCUMENTS

D522,484 S * 6/2006 Griffin D14/138
D529,909 S * 10/2006 Daw et al. D14/346
D545,803 S * 7/2007 Chen D14/138
D548,218 S * 8/2007 Hong et al. D14/138
D550,664 S * 9/2007 Leung D14/346
D559,223 S * 1/2008 Kim et al. D14/138
D561,723 S * 2/2008 Kim et al. D14/138

FIG. 1 is a front elevational view of a handheld device depicting our new design;
FIG. 2 is a left side view thereof;
FIG. 3 is a right side view thereof;
FIG. 4 is a top plan view thereof;
FIG. 5 is a bottom plan view thereof;
FIG. 6 is a rear elevational view thereof;
FIG. 7 is a perspective view thereof;
FIG. 8 is another perspective view thereof; and,
FIG. 9 is another perspective view thereof.

The broken line showing of portions of the handheld device forms no part of the claimed design.

1 Claim, 7 Drawing Sheets

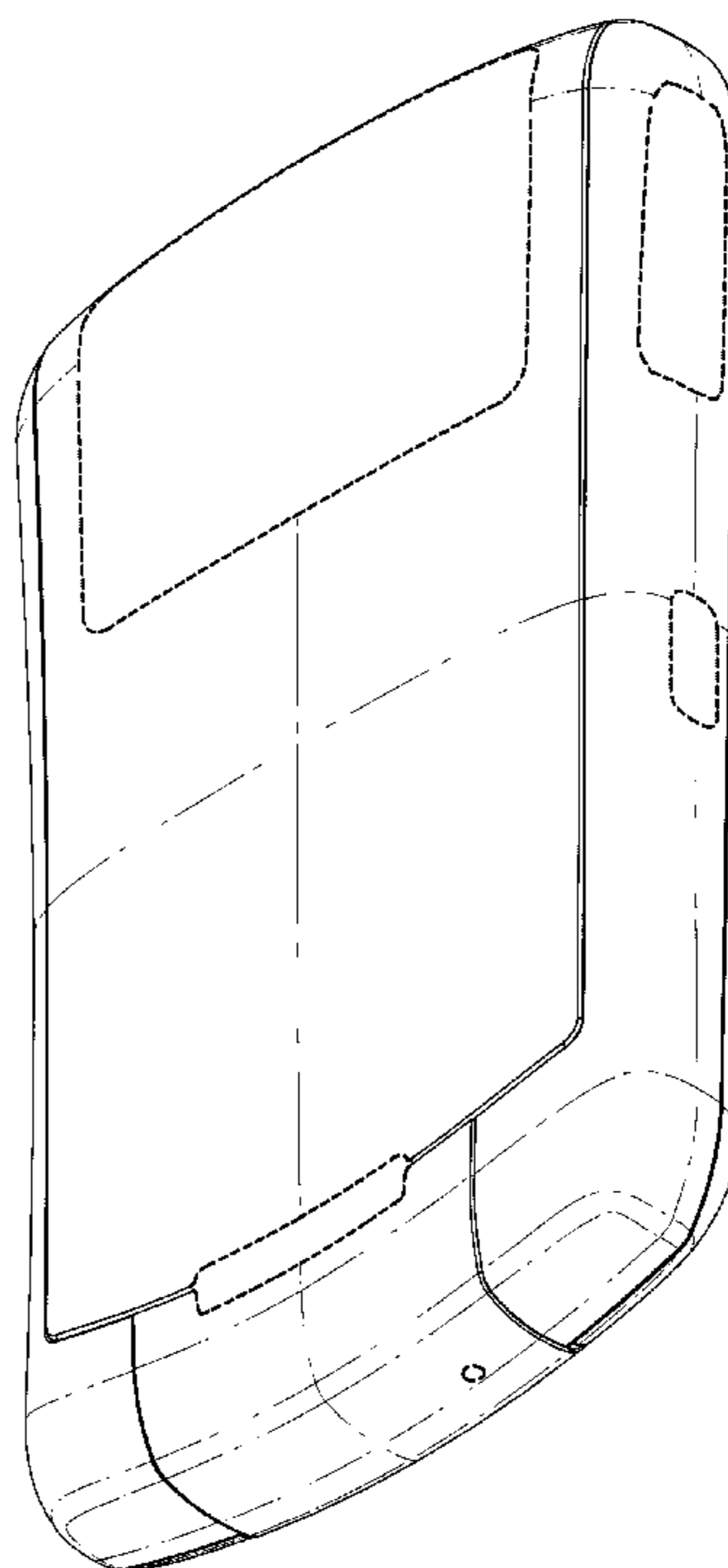
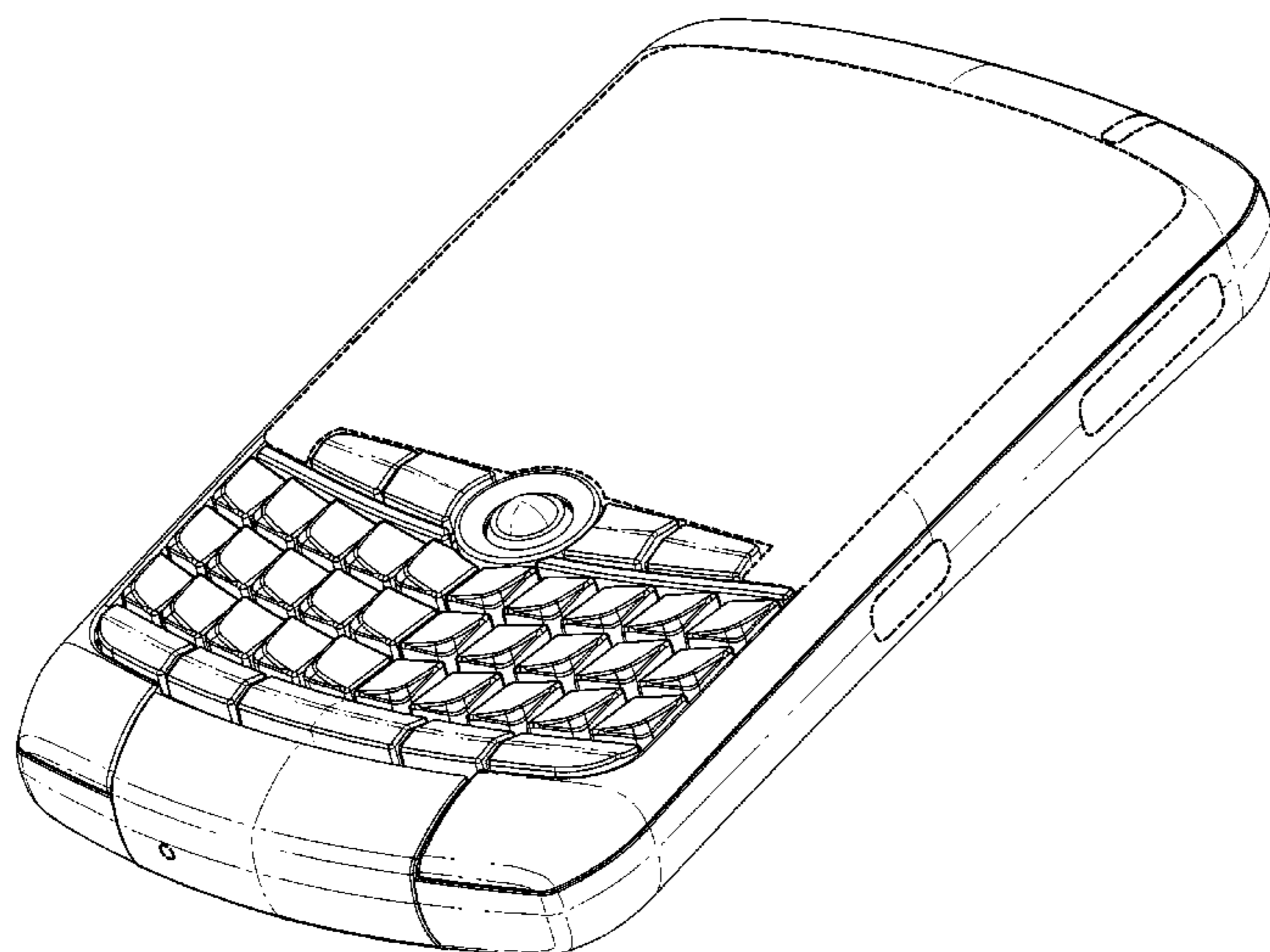

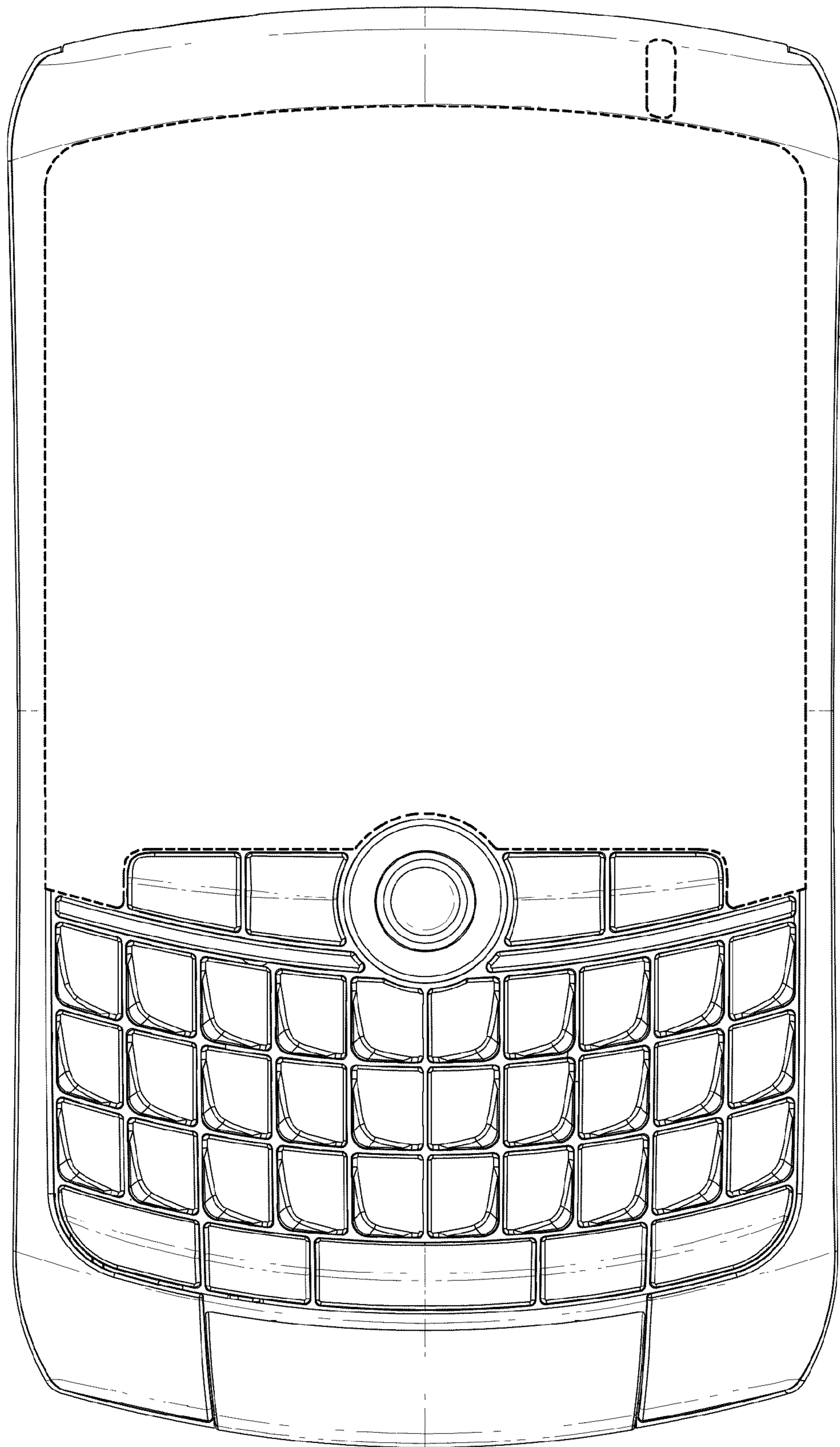

FIG. 1

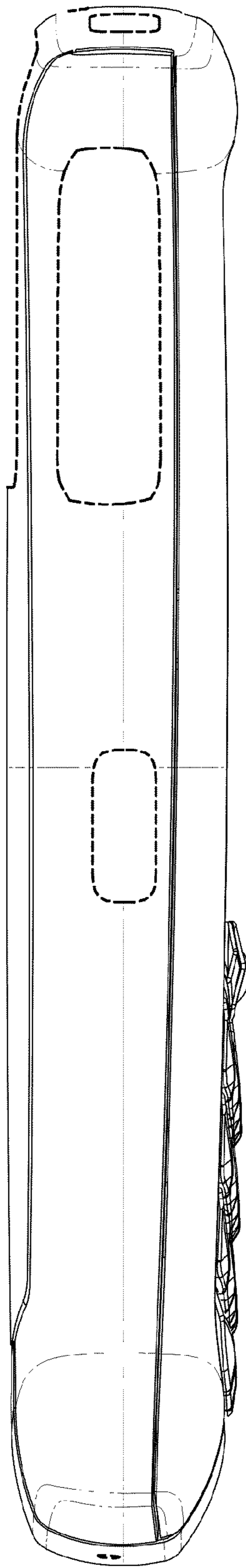

FIG. 2

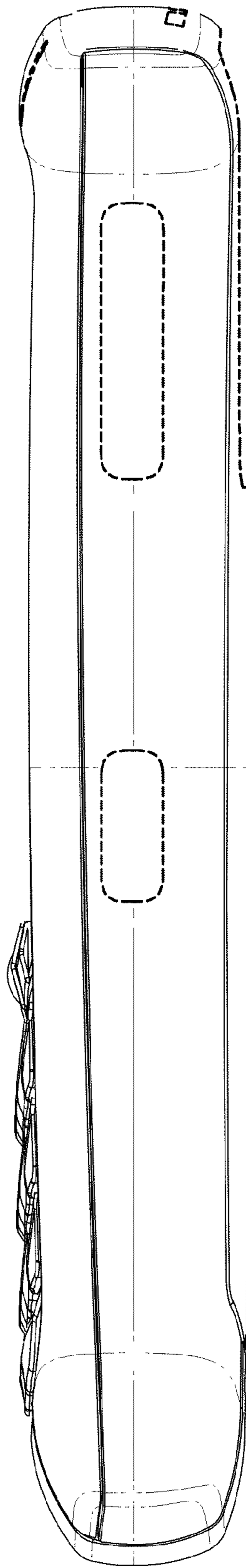

FIG. 3

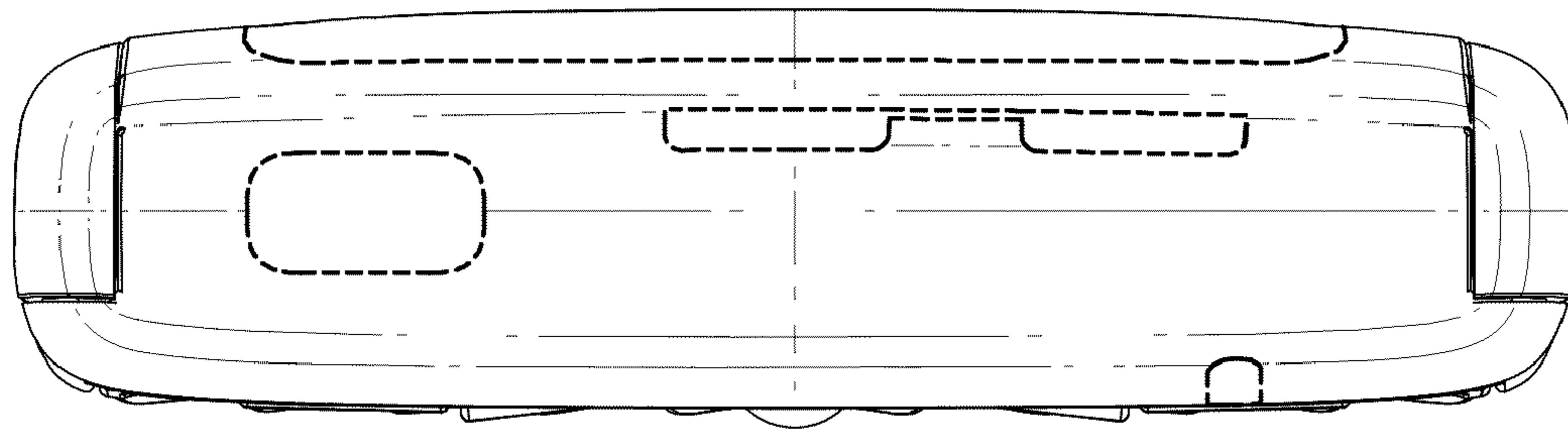

FIG. 4

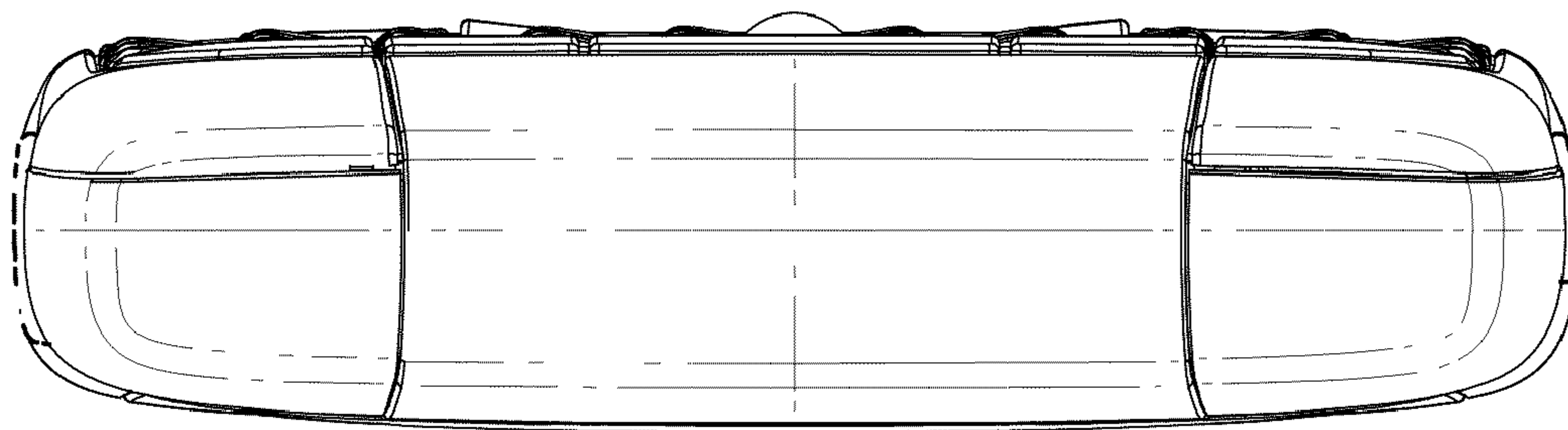

FIG. 5

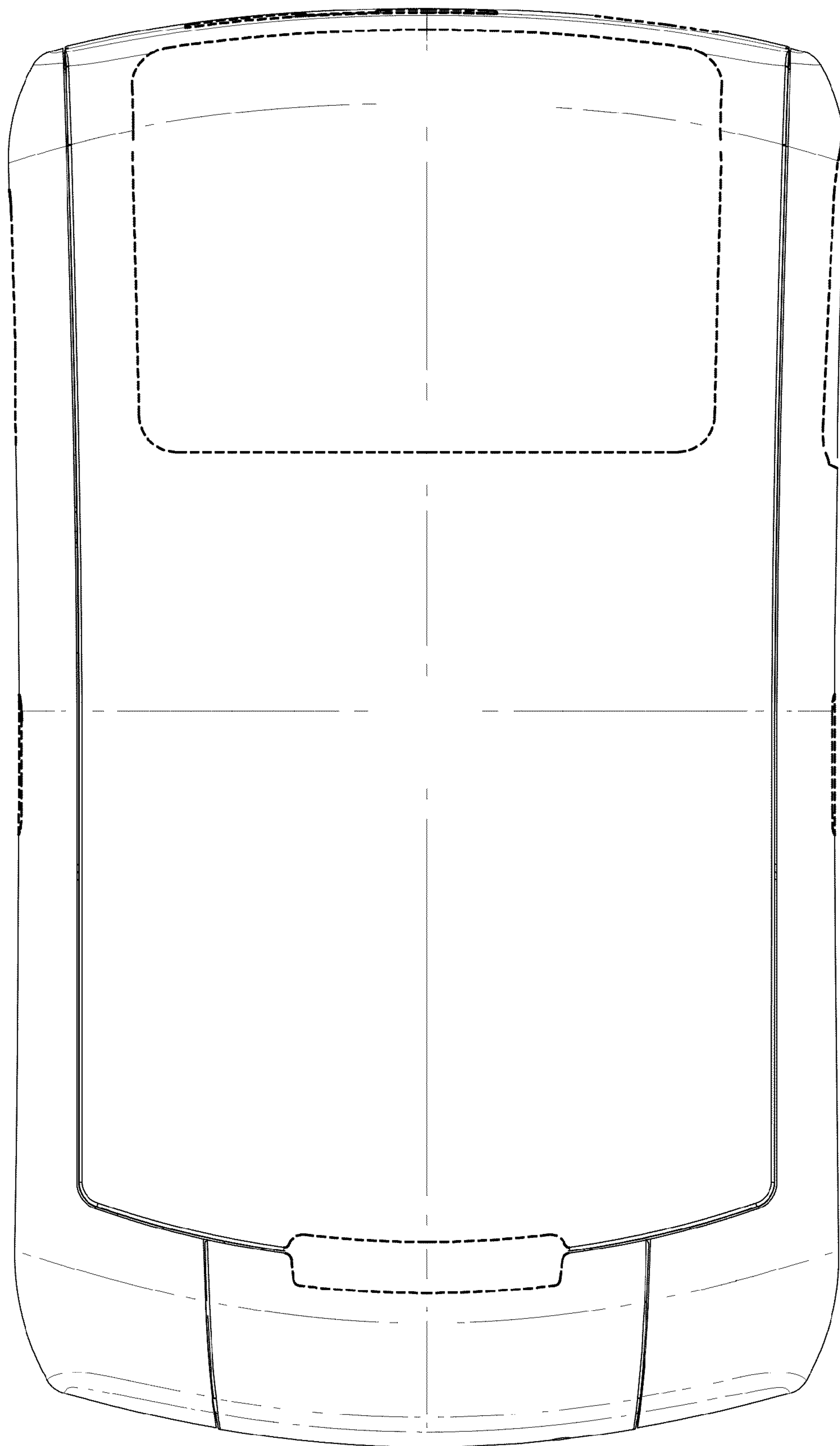

FIG. 6

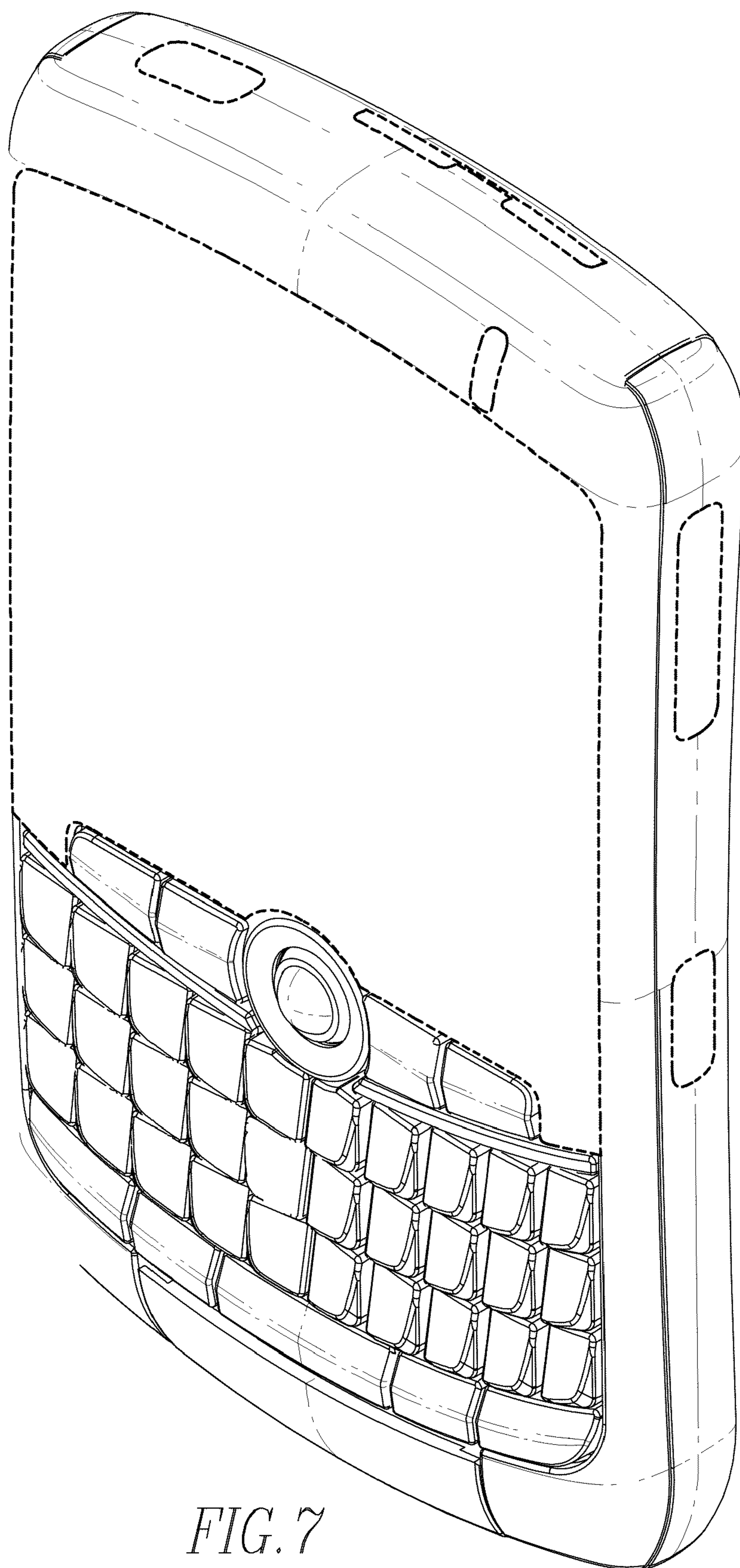

FIG. 7

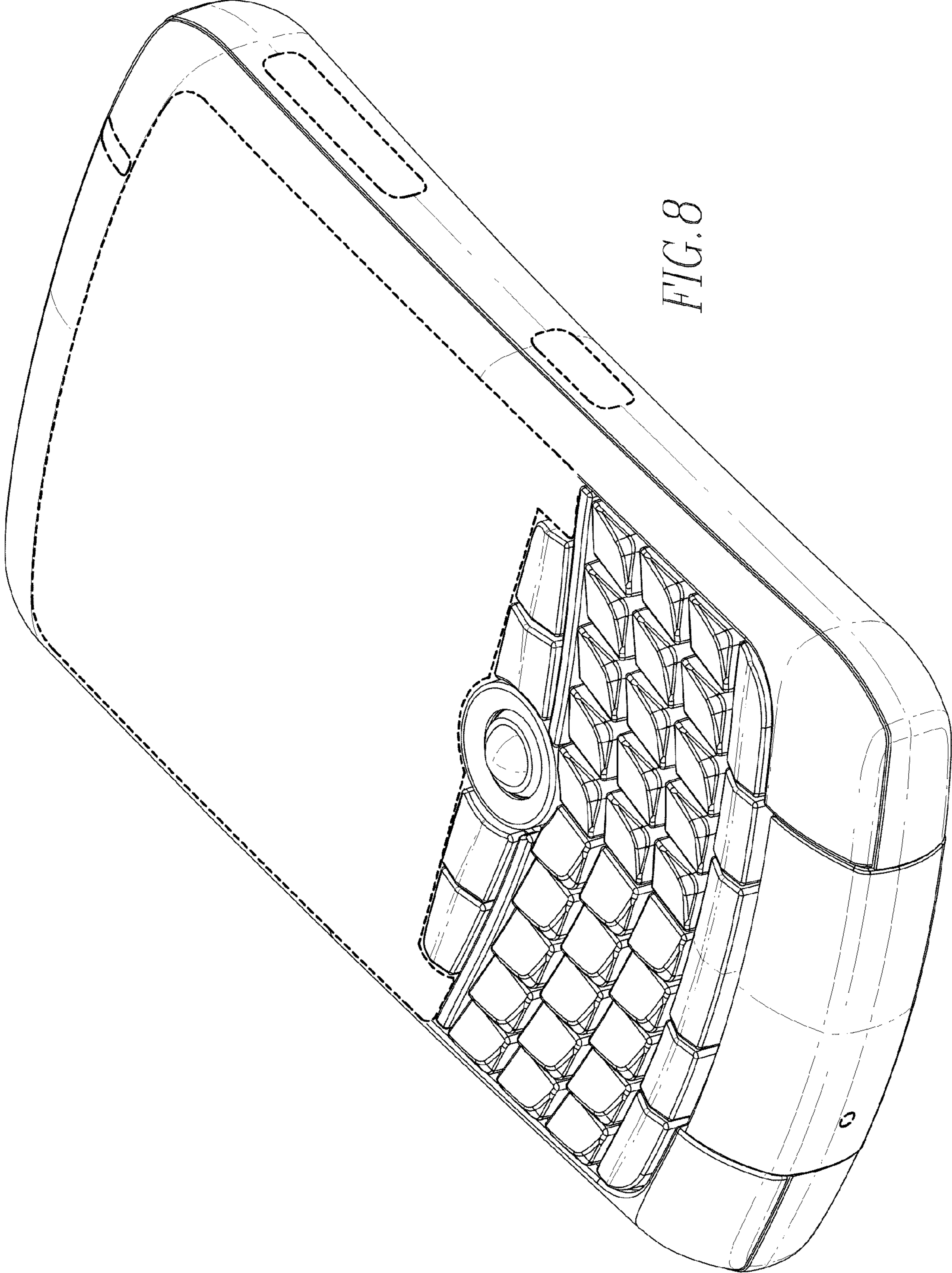

FIG. 8

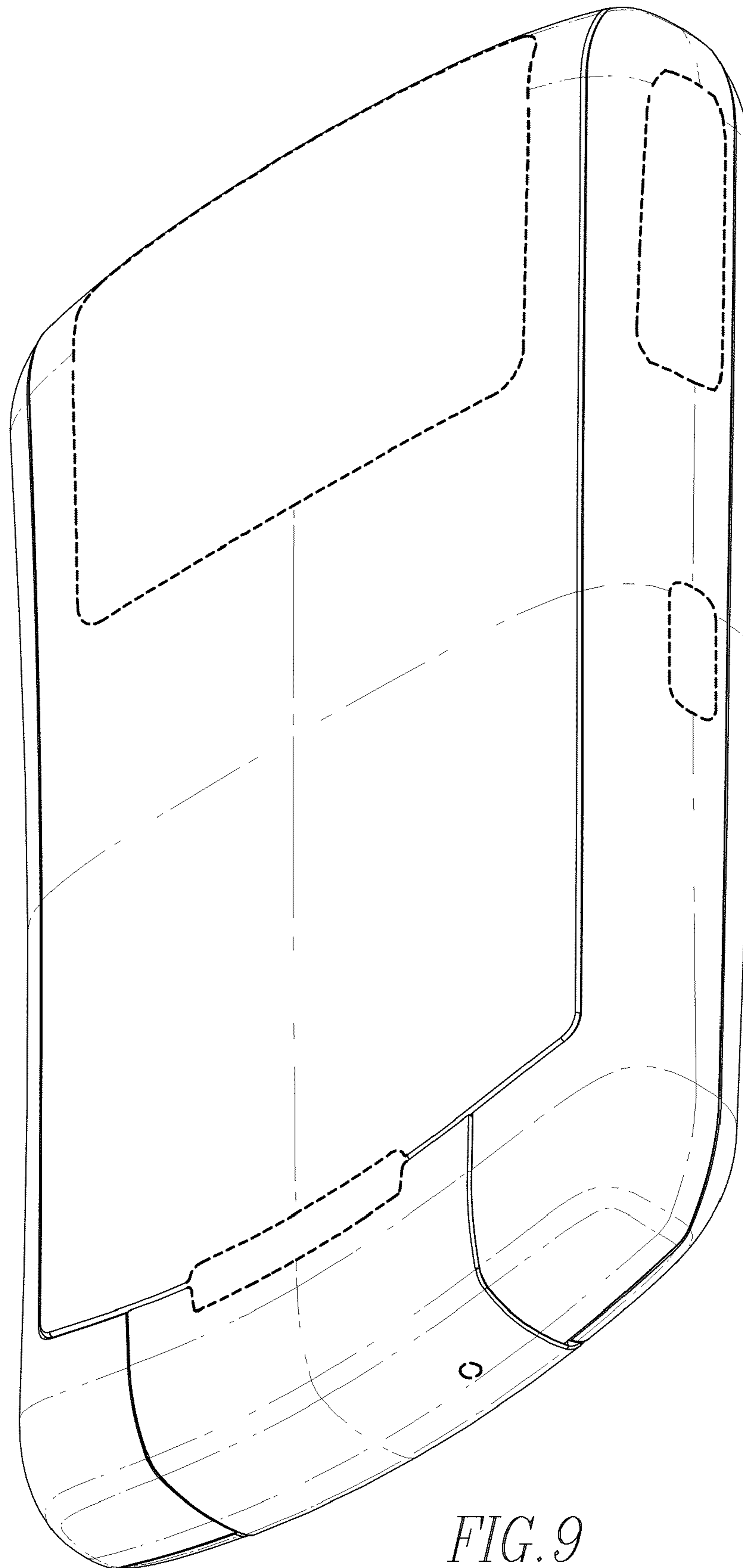

FIG. 9